



Chipsmall Limited consists of a professional team with an average of over 10 year of expertise in the distribution of electronic components. Based in Hongkong, we have already established firm and mutual-benefit business relationships with customers from,Europe,America and south Asia,supplying obsolete and hard-to-find components to meet their specific needs.

With the principle of "Quality Parts,Customers Priority,Honest Operation,and Considerate Service",our business mainly focus on the distribution of electronic components. Line cards we deal with include Microchip,ALPS,ROHM,Xilinx,Pulse,ON,Everlight and Freescale. Main products comprise IC,Modules,Potentiometer,IC Socket,Relay,Connector.Our parts cover such applications as commercial,industrial, and automotives areas.

We are looking forward to setting up business relationship with you and hope to provide you with the best service and solution. Let us make a better world for our industry!



Contact us

Tel: +86-755-8981 8866 Fax: +86-755-8427 6832

Email & Skype: info@chipsmall.com Web: www.chipsmall.com

Address: A1208, Overseas Decoration Building, #122 Zhenhua RD., Futian, Shenzhen, China



Middle Power LED Series
2835 0.5W Ra80

LM281B+



Designed for better lm/\$ (Ambient, Linear)

Features & Benefits

- 0.5W Class mid power LED
- Standard form factor for design flexibility (2.8 × 3.5 mm)



Table of Contents

1.	Characteristics	-----	3
2.	Product Code Information	-----	6
3.	Typical Characteristics Graphs	-----	16
4.	Outline Drawing & Dimension	-----	19
5.	Reliability Test Items & Conditions	-----	20
6.	Soldering Conditions	-----	21
7.	Tape & Reel	-----	22
8.	Label Structure	-----	25
9.	Packing Structure	-----	26
10.	Precautions in Handling & Use	-----	30

1. Characteristics

a) Absolute Maximum Rating

Item	Symbol	Rating	Unit	Condition
Ambient / Operating Temperature	T_a	-40 ~ +85	°C	-
Storage Temperature	T_{stg}	-40 ~ +85	°C	-
LED Junction Temperature	T_j	115	°C	-
Forward Current	I_F	160	mA	-
Peak Pulsed Forward Current	I_{FP}	300	mA	Duty 1/10, pulse width 10ms
Assembly Process Temperature	-	260 <10	°C s	-
ESD (HBM)	-	2	kV	-

Note:

Proper current derating must be observed to maintain junction temperature below the maximum at all time.

b) Electro-optical Characteristics (I_F = 150 mA, T_s = 25 °C)

Item	Unit	Rank	Bin	Min.	Typ.	Max.
Forward Voltage (VF)	V	WA or WK	A1	2.8		2.9
			A2	2.9		3.0
			A3	3.0		3.1
			A4	3.1		3.2
			A5	3.2		3.3
Color Rendering Index (Ra)	-	5		80	-	-
Thermal Resistance (junction to solder point)	°C/W			-	25	-
Beam Angle	°			-	120	-

Note:

Samsung maintains measurement tolerance of: forward voltage = ±0.1 V, CRI = ±3

b) Electro-optical Characteristics ($I_F = 150 \text{ mA}$, $T_s = 25 \text{ }^\circ\text{C}$)

Item	CRI (R _a) Min.	Nominal CCT (K)	Bin	150mA	
				Min.	Max.
Luminous Flux (Φ _v)	80	2700	SA	52.5	56.5
			SC	56.5	60.5
			SE	60.5	64.5
			SG	64.5	68.5
		3000	SA	54.5	58.5
			SC	58.5	62.5
			SE	62.5	66.5
			SG	66.5	70.5
		3500	SA	55.5	59.5
			SC	59.5	63.5
			SE	63.5	67.5
			SG	67.5	71.5
		4000	SA	58.0	62.0
			SC	62.0	66.0
			SE	66.0	70.0
			SG	70.0	74.0
		5000	SA	59.0	63.0
			SC	63.0	67.0
			SE	67.0	71.0
			SG	71.0	75.0
5700	SA	58.5	62.5		
	SC	62.5	66.5		
	SE	66.5	70.5		
	SG	70.5	74.5		
6500	SA	58.0	62.0		
	SC	62.0	66.0		
	SE	66.0	70.0		
	SG	70.0	74.0		

Note:

Samsung maintains measurement tolerance of: forward voltage = $\pm 0.1\text{V}$, luminous flux = $\pm 5\%$, CRI = ± 3

2. Product Code Information

1	2	3	4	5	6	7	8	9	10	11	12	13	14	15	16	17	18
S	P	M	W	H	1	2	2	8	F	D	5	W	A	R	0	S	C

Digit	PKG Information	Code	Specification	
1 2 3	Samsung Package Middle Power	SPM	Middle power	
4 5	Color	WH	White	
6	Product Version	1	1 st version	
7 8 9	Form Factor	228	2.8 x 3.5 x 0.65 mm; 2 pads	
10	Sorting Current (mA)	F	150 mA	
11	Chromaticity Coordinates	D	ANSI Standard	
12	CRI	5	Min. 80	
13 14	Forward Voltage (V)	WA or WK	2.8~3.2	Bin code A1 2.8 ~ 2.9 A2 2.9 ~ 3.0 A3 3.0 ~ 3.1 A4 3.1 ~ 3.2 A5 3.2 ~ 3.3
			WA : 4,000ea per reel ,WK : 12,000ea per reel	
15 16	CCT (K)	W☆ V☆ U☆ T☆ R☆ Q☆ P☆	Bin Code:	W1, W2, W3, W4, W5, W6, W7, W8, W9, WA, WB, WC, WD, WE, WF, WG V1, V2, V3, V4, V5, V6, V7, V8, V9, VA, VB, VC, VD, VE, VF, VG U1, U2, U3, U4, U5, U6, U7, U8, U9, UA, UB, UC, UD, UE, UF, UG T1, T2, T3, T4, T5, T6, T7, T8, T9, TA, TB, TC, TD, TE, TF, TG R1, R2, R3, R4, R5, R6, R7, R8, R9,RA, RB, RC, RD, RE, RF, RG Q1, Q2, Q3, Q4, Q5, Q6, Q7, Q8, Q9,QA, QB, QC, QD, QE, QF, QG P1, P2, P3, P4, P5, P6, P7, P8, P9,PA, PB, PC, PD, PE, PF, PG
			☆ : "0" (Whole bin) "M" (Quarter bin) or "K" (K Kitting bin)	
17 18	Luminous Flux	SA SC SE SG	Bin Code	SA SC SE SG

a) Luminous Flux Bins ($I_f = 150 \text{ mA}$, $T_s = 25^\circ\text{C}$)

CRI (R_a) Min.	Nominal CCT (K)	Product Code	Flux Bin	Flux Range (Φ_v , lm)
80	2700	SPMWH1228FD5WAW☆SA	SA	52.5 ~ 56.5
		SPMWH1228FD5WAW☆SC	SC	56.5 ~ 60.5
		SPMWH1228FD5WAW☆SE	SE	60.5 ~ 64.5
		SPMWH1228FD5WAW☆SG	SG	64.5 ~ 68.5
	3000	SPMWH1228FD5WAV☆SA	SA	54.5 ~ 58.5
		SPMWH1228FD5WAV☆SC	SC	58.5 ~ 62.5
		SPMWH1228FD5WAV☆SE	SE	62.5 ~ 66.5
		SPMWH1228FD5WAV☆SG	SG	66.5 ~ 70.5
	3500	SPMWH1228FD5WAU☆SA	SA	55.5 ~ 59.5
		SPMWH1228FD5WAU☆SC	SC	59.5 ~ 63.5
		SPMWH1228FD5WAU☆SE	SE	63.5 ~ 67.5
		SPMWH1228FD5WAU☆SG	SG	67.5 ~ 71.5
	4000	SPMWH1228FD5WAT☆SA	SA	58.0 ~ 62.0
		SPMWH1228FD5WAT☆SC	SC	62.0 ~ 66.0
		SPMWH1228FD5WAT☆SE	SE	66.0 ~ 70.0
		SPMWH1228FD5WAT☆SG	SG	70.0 ~ 74.0
	5000	SPMWH1228FD5WAR☆SA	SA	59.0 ~ 63.0
		SPMWH1228FD5WAR☆SC	SC	63.0 ~ 67.0
		SPMWH1228FD5WAR☆SE	SE	67.0 ~ 71.0
		SPMWH1228FD5WAR☆SG	SG	71.0 ~ 75.0
5700	SPMWH1228FD5WAQ☆SA	SA	58.5 ~ 62.5	
	SPMWH1228FD5WAQ☆SC	SC	62.5 ~ 66.5	
	SPMWH1228FD5WAQ☆SE	SE	66.5 ~ 70.5	
	SPMWH1228FD5WAQ☆SG	SG	70.5 ~ 74.5	
6500	SPMWH1228FD5WAP☆SA	SA	58.0 ~ 62.0	
	SPMWH1228FD5WAP☆SC	SC	62.0 ~ 66.0	
	SPMWH1228FD5WAP☆SE	SE	66.0 ~ 70.0	
	SPMWH1228FD5WAP☆SG	SG	70.0 ~ 74.0	

Note:

"☆" can be "0" (Whole bin), "M" (Quarter bin) or "K" (K Kitting bin) of the color binning

b) Kitting rule

1) K Kitting bin Concept

1. Under agreement between customer and SAMSUNG ELECTRONICS, SAMSUNG can supply kitting bin (VF, Color, Im).
2. A forward voltage (VF) of kitting bin is combined by a pair of same VF rank such as (A1+A1), (A2+A2), (A3+A3), (A4+A4) or (A5+A5).
3. A Chromaticity Coordinates of kitting bin is mixed by kitting procedure.(below kitting simulation)

[Kitting example]

D	E	F	G
9	A	B	C
5	6	7	8
1	2	3	4

[Binning Information]

	Bin #1	Bin #2
VF	A1	A1
	A2	A2
	A3	A3
	A4	A4
	A5	A5
CIE	1, 2, 5 bin	C, F, G bin
	6, 7, A, B bin	6, 7, A, B bin
	3, 4, 8 bin	9, D, E bin

c) Color Bins ($I_F = 150 \text{ mA}$, $T_s = 25 \text{ }^\circ\text{C}$)

CRI (R _a) Min.	Nominal CCT (K)	Product Code	Color Rank	Chromaticity Bins
80	2700	SPMWH1228FD5WAW0S★	W0 (Whole bin)	W1, W2, W3, W4, W5, W6, W7, W8, W9, WA, WB, WC, WD, WE, WF, WG
		SPMWH1228FD5WAWMS★	WM (Quarter bin)	W6, W7, WA, WB
		SPMWH1228FD5WAWKS★	WK (K Kitting bin)	W1, W2, W3, W4, W5, W6, W7, W8, W9, WA, WB, WC, WD, WE, WF, WG
		SPMWH1228FD5WAV0S★	V0 (Whole bin)	V1, V2, V3, V4, V5, V6, V7, V8, V9, VA, VB, VC, VD, VE, VF, VG
		SPMWH1228FD5WAVMS★	VM (Quarter bin)	V6, V7, VA, VB
		SPMWH1228FD5WAVKS★	VK (K Kitting bin)	V1, V2, V3, V4, V5, V6, V7, V8, V9, VA, VB, VC, VD, VE, VF, VG
	3000	SPMWH1228FD5WAU0S★	U0 (Whole bin)	U1, U2, U3, U4, U5, U6, U7, U8, U9, UA, UB, UC, UD, UE, UF, UG
		SPMWH1228FD5WAUMS★	UM (Quarter bin)	U6, U7, UA, UB
		SPMWH1228FD5WAUKS★	UK (K Kitting bin)	U1, U2, U3, U4, U5, U6, U7, U8, U9, UA, UB, UC, UD, UE, UF, UG
		SPMWH1228FD5WAT0S★	T0 (Whole bin)	T1, T2, T3, T4, T5, T6, T7, T8, T9, TA, TB, TC, TD, TE, TF, TG
		SPMWH1228FD5WATMS★	TM (Quarter bin)	T6, T7, TA, TB
		SPMWH1228FD5WATKS★	TK (K Kitting bin)	T1, T2, T3, T4, T5, T6, T7, T8, T9, TA, TB, TC, TD, TE, TF, TG
	4000	SPMWH1228FD5WAR0S★	R0 (Whole bin)	R1, R2, R3, R4, R5, R6, R7, R8, R9, RA, RB, RC, RD, RE, RF, RG
		SPMWH1228FD5WARMS★	RM (Quarter bin)	R6, R7, RA, RB
		SPMWH1228FD5WARKS★	RK (K Kitting bin)	R1, R2, R3, R4, R5, R6, R7, R8, R9, RA, RB, RC, RD, RE, RF, RG
		SPMWH1228FD5WAQ0S★	Q0 (Whole bin)	Q1, Q2, Q3, Q4, Q5, Q6, Q7, Q8, Q9, QA, QB, QC, QD, QE, QF, QG
		SPMWH1228FD5WAQMS★	QM (Quarter bin)	Q6, Q7, QA, QB
		SPMWH1228FD5WAQKS★	QK (K Kitting bin)	Q1, Q2, Q3, Q4, Q5, Q6, Q7, Q8, Q9, QA, QB, QC, QD, QE, QF, QG
	5000	SPMWH1228FD5WAP0S★	P0 (Whole bin)	P1, P2, P3, P4, P5, P6, P7, P8, P9, PA, PB, PC, PD, PE, PF, PG
		SPMWH1228FD5WAPMS★	PM (Quarter bin)	P6, P7, PA, PB
		SPMWH1228FD5WAPKS★	PK (K Kitting bin)	P1, P2, P3, P4, P5, P6, P7, P8, P9, PA, PB, PC, PD, PE, PF, PG

Note:

★ can be "SA", "SC", "SE" or "SG" of luminous flux bin

d) Voltage Bins ($I_F = 150 \text{ mA}$, $T_s = 25 \text{ }^\circ\text{C}$)

CRI (R _a) Min.	Nominal CCT (K)	Product Code	Voltage Rank	Voltage Bin	Voltage Range (V)
-	-	-	WA or WK	A1	2.8 ~ 2.9
				A2	2.9 ~ 3.0
				A3	3.0 ~ 3.1
				A4	3.1 ~ 3.2
				A5	3.2 ~ 3.3

e) Chromaticity Region & Coordinates ($I_F = 150 \text{ mA}$, $T_s = 25 \text{ }^\circ\text{C}$)

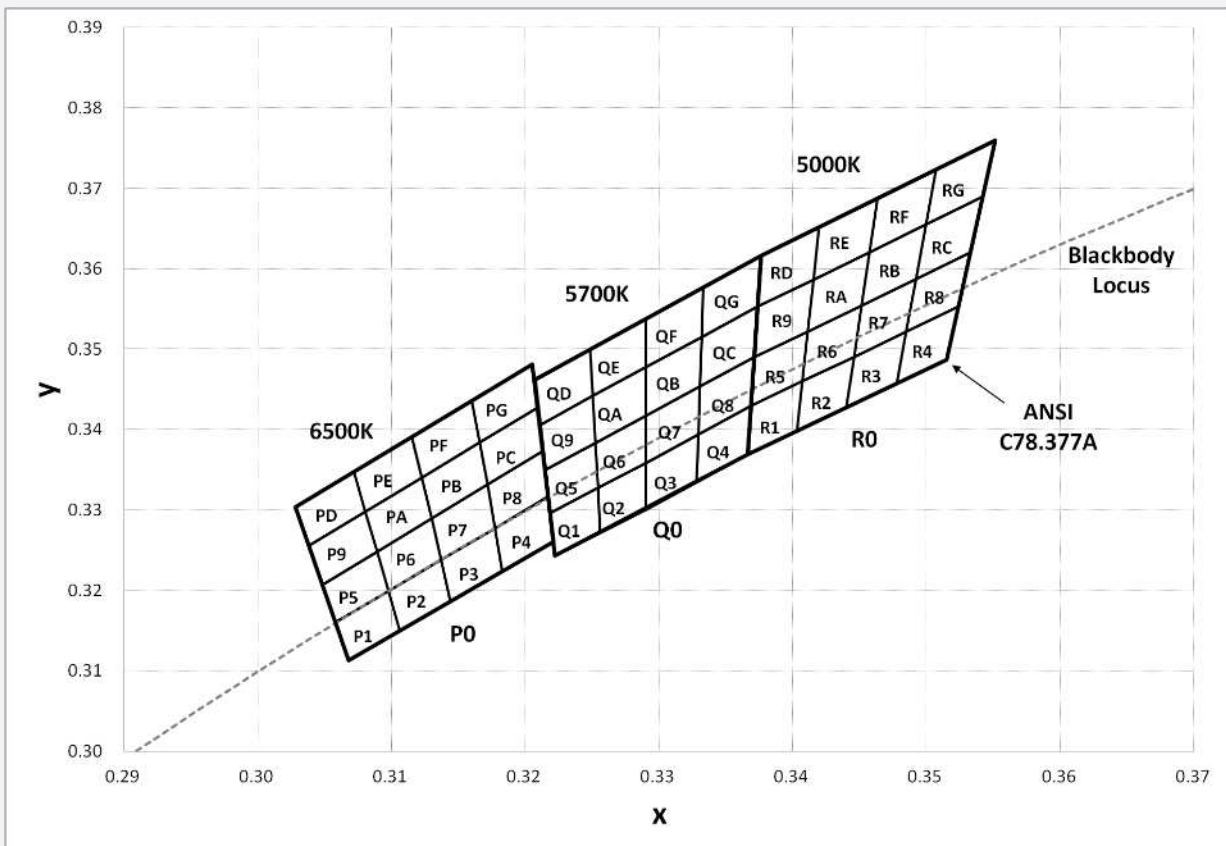
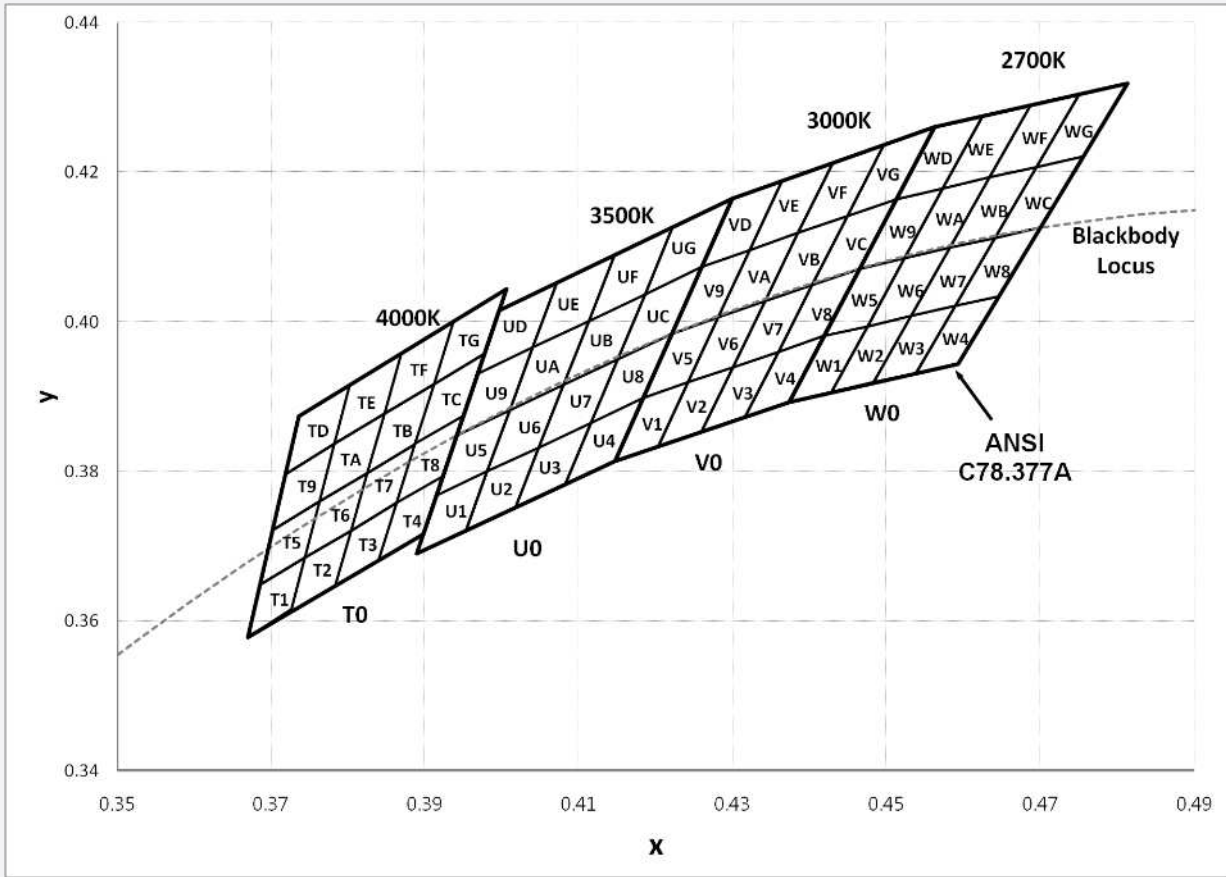

e) Chromaticity Region & Coordinates

Region	CIE x	CIE y	Region	CIE x	CIE y
W rank (2700 K)					
W1	0.4373	0.3893	W9	0.4465	0.4071
	0.4418	0.3981		0.4513	0.4164
	0.4475	0.3994		0.4573	0.4178
	0.4428	0.3906		0.4523	0.4085
W2	0.4428	0.3906	WA	0.4523	0.4085
	0.4475	0.3994		0.4573	0.4178
	0.4532	0.4008		0.4634	0.4193
	0.4483	0.3919		0.4582	0.4099
W3	0.4483	0.3919	WB	0.4582	0.4099
	0.4532	0.4008		0.4634	0.4193
	0.4589	0.4021		0.4695	0.4207
	0.4538	0.3931		0.4641	0.4112
W4	0.4538	0.3931	WC	0.4641	0.4112
	0.4589	0.4021		0.4695	0.4207
	0.4646	0.4034		0.4756	0.4221
	0.4593	0.3944		0.4700	0.4126
W5	0.4418	0.3981	WD	0.4513	0.4164
	0.4465	0.4071		0.4562	0.4260
	0.4523	0.4085		0.4624	0.4274
	0.4475	0.3994		0.4573	0.4178
W6	0.4475	0.3994	WE	0.4573	0.4178
	0.4523	0.4085		0.4624	0.4274
	0.4582	0.4099		0.4687	0.4289
	0.4532	0.4008		0.4634	0.4193
W7	0.4532	0.4008	WF	0.4634	0.4193
	0.4582	0.4099		0.4687	0.4289
	0.4641	0.4112		0.4750	0.4304
	0.4589	0.4021		0.4695	0.4207
W8	0.4589	0.4021	WG	0.4695	0.4207
	0.4641	0.4112		0.4750	0.4304
	0.4700	0.4126		0.4813	0.4319
	0.4646	0.4034		0.4756	0.4221

Region	CIE x	CIE y	Region	CIE x	CIE y
V rank (3000 K)					
V1	0.4147	0.3814	V9	0.4221	0.3984
	0.4183	0.3898		0.4259	0.4073
	0.4242	0.3919		0.4322	0.4096
	0.4203	0.3833		0.4281	0.4006
V2	0.4203	0.3833	VA	0.4281	0.4006
	0.4242	0.3919		0.4322	0.4096
	0.4300	0.3939		0.4385	0.4119
	0.4259	0.3853		0.4342	0.4028
V3	0.4259	0.3853	VB	0.4342	0.4028
	0.4300	0.3939		0.4385	0.4119
	0.4359	0.3960		0.4449	0.4141
	0.4316	0.3873		0.4403	0.4049
V4	0.4316	0.3873	VC	0.4403	0.4049
	0.4359	0.3960		0.4449	0.4141
	0.4418	0.3981		0.4513	0.4164
	0.4373	0.3893		0.4465	0.4071
V5	0.4183	0.3898	VD	0.4259	0.4073
	0.4221	0.3984		0.4299	0.4165
	0.4281	0.4006		0.4364	0.4188
	0.4242	0.3919		0.4322	0.4096
V6	0.4242	0.3919	VE	0.4322	0.4096
	0.4281	0.4006		0.4364	0.4188
	0.4342	0.4028		0.4430	0.4212
	0.4300	0.3939		0.4385	0.4119
V7	0.4300	0.3939	VF	0.4385	0.4119
	0.4342	0.4028		0.4430	0.4212
	0.4403	0.4049		0.4496	0.4236
	0.4359	0.3960		0.4449	0.4141
V8	0.4359	0.3960	VG	0.4449	0.4141
	0.4403	0.4049		0.4496	0.4236
	0.4465	0.4071		0.4562	0.4260
	0.4418	0.3981		0.4513	0.4164

e) Chromaticity Region & Coordinates

Region	CIE x	CIE y	Region	CIE x	CIE y
U rank (3500 K)					
U1	0.3889	0.3690	U9	0.3941	0.3848
	0.3915	0.3768		0.3968	0.3930
	0.3981	0.3800		0.4040	0.3966
	0.3953	0.3720		0.4010	0.3882
U2	0.3953	0.3720	UA	0.4010	0.3882
	0.3981	0.3800		0.4040	0.3966
	0.4048	0.3832		0.4113	0.4001
	0.4017	0.3751		0.4080	0.3916
U3	0.4017	0.3751	UB	0.4080	0.3916
	0.4048	0.3832		0.4113	0.4001
	0.4116	0.3865		0.4186	0.4037
	0.4082	0.3782		0.4150	0.3950
U4	0.4082	0.3782	UC	0.4150	0.3950
	0.4116	0.3865		0.4186	0.4037
	0.4183	0.3898		0.4259	0.4073
	0.4147	0.3814		0.4221	0.3984
U5	0.3915	0.3768	UD	0.3968	0.3930
	0.3941	0.3848		0.3996	0.4015
	0.4010	0.3882		0.4071	0.4052
	0.3981	0.3800		0.4040	0.3966
U6	0.3981	0.3800	UE	0.4040	0.3966
	0.4010	0.3882		0.4071	0.4052
	0.4080	0.3916		0.4146	0.4089
	0.4048	0.3832		0.4113	0.4001
U7	0.4048	0.3832	UF	0.4113	0.4001
	0.4080	0.3916		0.4146	0.4089
	0.4150	0.3950		0.4222	0.4127
	0.4116	0.3865		0.4186	0.4037
U8	0.4116	0.3865	UG	0.4186	0.4037
	0.4150	0.3950		0.4222	0.4127
	0.4221	0.3984		0.4299	0.4165
	0.4183	0.3898		0.4259	0.4073

Region	CIE x	CIE y	Region	CIE x	CIE y
T rank (4000 K)					
T1	0.3670	0.3578	T9	0.3702	0.3722
	0.3726	0.3612		0.3763	0.3760
	0.3744	0.3685		0.3782	0.3837
	0.3686	0.3649		0.3719	0.3797
T2	0.3726	0.3612	TA	0.3763	0.3760
	0.3783	0.3646		0.3825	0.3798
	0.3804	0.3721		0.3847	0.3877
	0.3744	0.3685		0.3782	0.3837
T3	0.3783	0.3646	TB	0.3825	0.3798
	0.3840	0.3681		0.3887	0.3836
	0.3863	0.3758		0.3912	0.3917
	0.3804	0.3721		0.3847	0.3877
T4	0.3840	0.3681	TC	0.3887	0.3837
	0.3898	0.3716		0.3950	0.3875
	0.3924	0.3794		0.3978	0.3958
	0.3863	0.3758		0.3912	0.3917
T5	0.3686	0.3649	TD	0.3719	0.3797
	0.3744	0.3685		0.3782	0.3837
	0.3763	0.3760		0.3802	0.3916
	0.3702	0.3722		0.3736	0.3874
T6	0.3744	0.3685	TE	0.3782	0.3837
	0.3804	0.3721		0.3847	0.3877
	0.3825	0.3798		0.3869	0.3958
	0.3763	0.3760		0.3802	0.3916
T7	0.3804	0.3721	TF	0.3847	0.3877
	0.3863	0.3758		0.3912	0.3917
	0.3887	0.3836		0.3937	0.4001
	0.3825	0.3798		0.3869	0.3958
T8	0.3863	0.3758	TG	0.3912	0.3917
	0.3924	0.3794		0.3978	0.3958
	0.3950	0.3875		0.4006	0.4044
	0.3887	0.3836		0.3937	0.4001

e) Chromaticity Region & Coordinates

Region	CIE x	CIE y	Region	CIE x	CIE y
R rank (5000 K)					
R1	0.3366	0.3369	R9	0.3374	0.3554
	0.3369	0.3431		0.3371	0.3493
	0.3407	0.3460		0.3411	0.3522
	0.3403	0.3398		0.3415	0.3587
R2	0.3403	0.3398	RA	0.3415	0.3587
	0.3407	0.3460		0.3411	0.3522
	0.3446	0.3491		0.3451	0.3554
	0.3440	0.3427		0.3457	0.3621
R3	0.3446	0.3491	RB	0.3451	0.3554
	0.3440	0.3427		0.3457	0.3621
	0.3477	0.3458		0.3500	0.3655
	0.3485	0.3522		0.3492	0.3587
R4	0.3485	0.3522	RC	0.3492	0.3587
	0.3477	0.3458		0.3500	0.3655
	0.3514	0.3487		0.3542	0.3690
	0.3524	0.3554		0.3533	0.3620
R5	0.3371	0.3493	RD	0.3376	0.3616
	0.3369	0.3431		0.3374	0.3554
	0.3407	0.3460		0.3415	0.3587
	0.3411	0.3522		0.3420	0.3652
R6	0.3407	0.3460	RE	0.3415	0.3587
	0.3411	0.3522		0.3420	0.3652
	0.3451	0.3554		0.3463	0.3687
	0.3446	0.3491		0.3457	0.3621
R7	0.3446	0.3491	RF	0.3457	0.3621
	0.3451	0.3554		0.3463	0.3687
	0.3492	0.3587		0.3507	0.3724
	0.3485	0.3522		0.3500	0.3655
R8	0.3485	0.3522	RG	0.3500	0.3655
	0.3492	0.3587		0.3507	0.3724
	0.3533	0.3620		0.3551	0.3760
	0.3524	0.3554		0.3542	0.3690

Region	CIE x	CIE y	Region	CIE x	CIE y
Q rank (5700 K)					
Q1	0.3218	0.3298	Q9	0.3211	0.3407
	0.3222	0.3243		0.3215	0.3353
	0.3258	0.3275		0.3254	0.3388
	0.3256	0.3331		0.3252	0.3444
Q2	0.3256	0.3331	QA	0.3252	0.3444
	0.3258	0.3275		0.3254	0.3388
	0.3294	0.3306		0.3293	0.3423
	0.3294	0.3364		0.3293	0.3481
Q3	0.3294	0.3364	QB	0.3293	0.3481
	0.3294	0.3306		0.3293	0.3423
	0.3330	0.3338		0.3332	0.3458
	0.3331	0.3398		0.3333	0.3518
Q4	0.3331	0.3398	QC	0.3333	0.3518
	0.3330	0.3338		0.3332	0.3458
	0.3366	0.3369		0.3371	0.3493
	0.3369	0.3431		0.3374	0.3554
Q5	0.3215	0.3353	QD	0.3207	0.3462
	0.3218	0.3298		0.3211	0.3407
	0.3256	0.3331		0.3252	0.3444
	0.3254	0.3388		0.3250	0.3501
Q6	0.3254	0.3388	QE	0.3250	0.3501
	0.3256	0.3331		0.3252	0.3444
	0.3294	0.3364		0.3293	0.3481
	0.3293	0.3423		0.3292	0.3539
Q7	0.3293	0.3423	QF	0.3292	0.3539
	0.3294	0.3364		0.3293	0.3481
	0.3331	0.3398		0.3333	0.3518
	0.3332	0.3458		0.3334	0.3578
Q8	0.3332	0.3458	QG	0.3334	0.3578
	0.3331	0.3398		0.3333	0.3518
	0.3369	0.3431		0.3374	0.3554
	0.3371	0.3493		0.3376	0.3616

e) Chromaticity Region & Coordinates

Region	CIE x	CIE y	Region	CIE x	CIE y
P rank (6500 K)					
P1	0.3068	0.3113	P9	0.3048	0.3207
	0.3106	0.3150		0.3089	0.3249
	0.3098	0.3199		0.3080	0.3298
	0.3058	0.3160		0.3038	0.3256
P2	0.3106	0.3150	PA	0.3089	0.3249
	0.3144	0.3186		0.313	0.3290
	0.3137	0.3238		0.3123	0.3341
	0.3098	0.3199		0.3080	0.3298
P3	0.3144	0.3186	PB	0.3130	0.3290
	0.3183	0.3224		0.3172	0.3332
	0.3177	0.3278		0.3166	0.3384
	0.3137	0.3238		0.3123	0.3341
P4	0.3183	0.3224	PC	0.3172	0.3332
	0.3221	0.3261		0.3214	0.3373
	0.3218	0.3317		0.3210	0.3427
	0.3177	0.3278		0.3166	0.3384
P5	0.3058	0.3160	PD	0.3038	0.3256
	0.3098	0.3199		0.3080	0.3298
	0.3089	0.3249		0.3072	0.3348
	0.3048	0.3207		0.3028	0.3304
P6	0.3098	0.3199	PE	0.3080	0.3298
	0.3137	0.3238		0.3123	0.3341
	0.3130	0.3290		0.3115	0.3391
	0.3089	0.3249		0.3072	0.3348
P7	0.3137	0.3238	PF	0.3123	0.3341
	0.3177	0.3278		0.3166	0.3384
	0.3172	0.3332		0.3160	0.3436
	0.313	0.3290		0.3115	0.3391
P8	0.3177	0.3278	PG	0.3166	0.3384
	0.3218	0.3317		0.3210	0.3427
	0.3214	0.3373		0.3206	0.3481
	0.3172	0.3332		0.3160	0.3436

Note: Samsung maintains measurement tolerance of: Cx, Cy = ±0.005

3. Typical Characteristics Graphs

a) Spectrum Distribution ($I_f = 150 \text{ mA}$, $T_s = 25 \text{ }^\circ\text{C}$)

CCT: 2700 K (80 CRI)

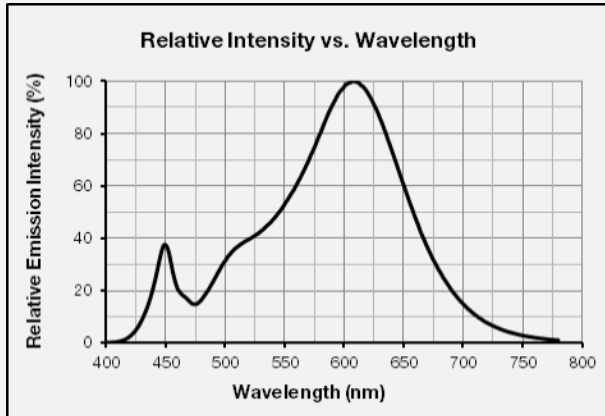

CCT: 3000 K (80 CRI)

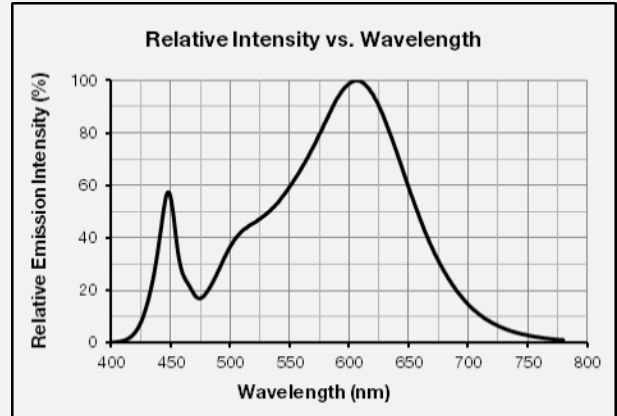

CCT: 3500 K (80 CRI)

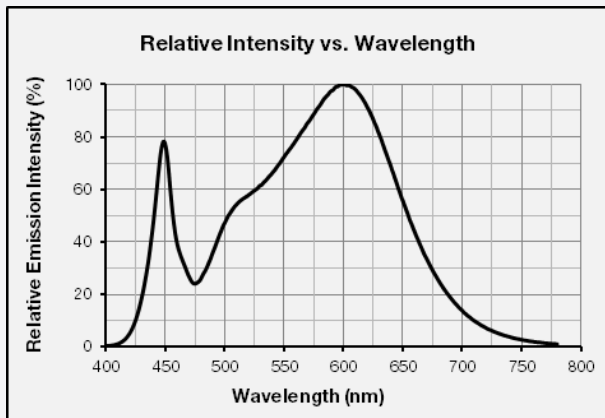

CCT: 4000 K (80 CRI)

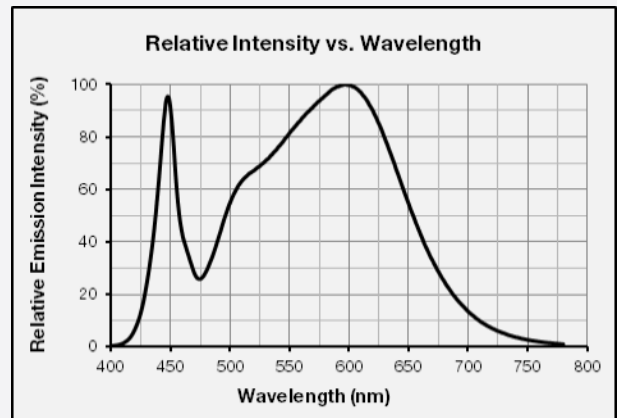

CCT: 5000 K (80 CRI)

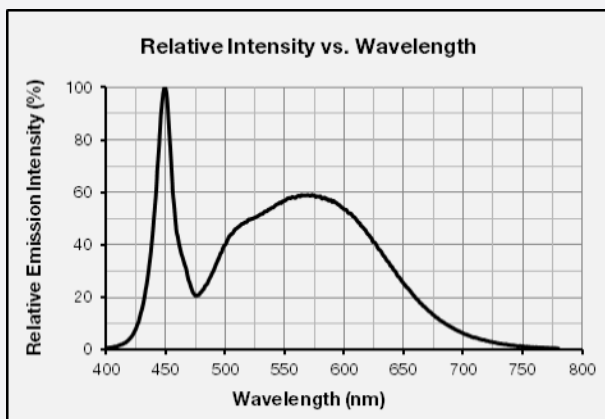

CCT: 5700 K (80 CRI)

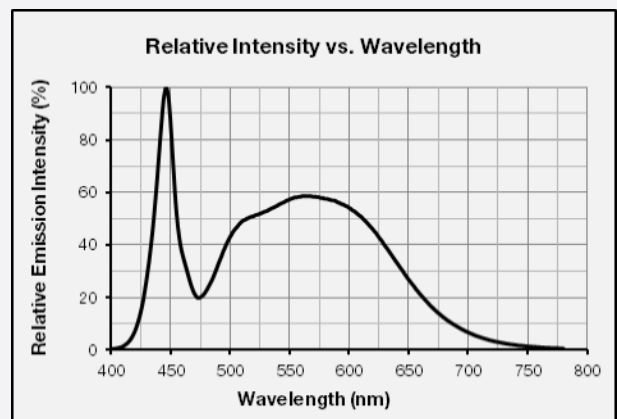

CCT: 6500 K (80 CRI)

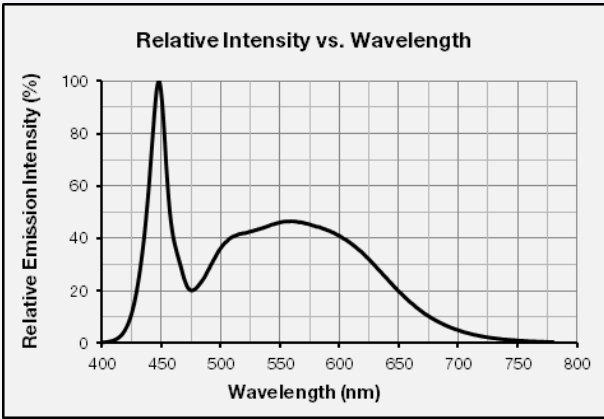

b) Forward Current Characteristics ($T_s = 25\text{ }^\circ\text{C}$)

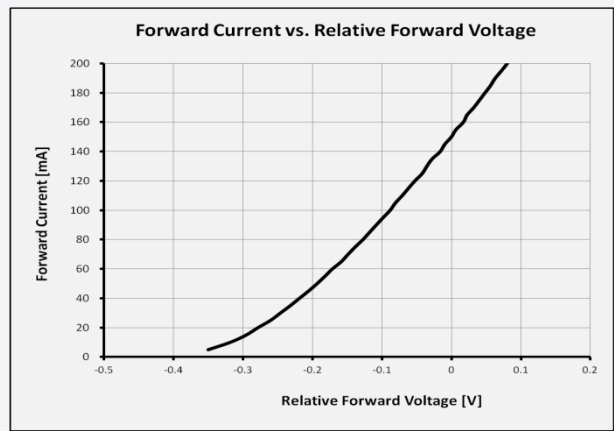
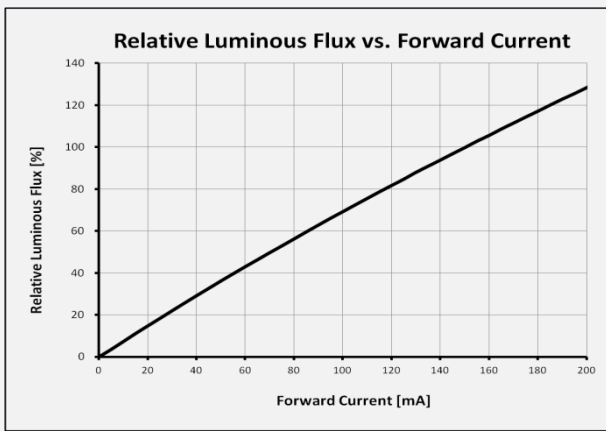

c) Temperature Characteristics ($I_f = 150\text{ mA}$)

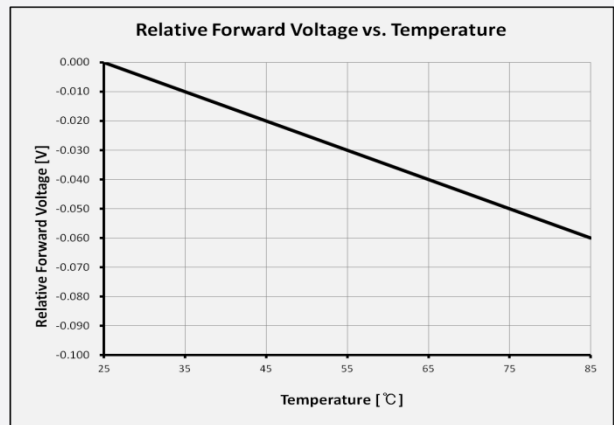
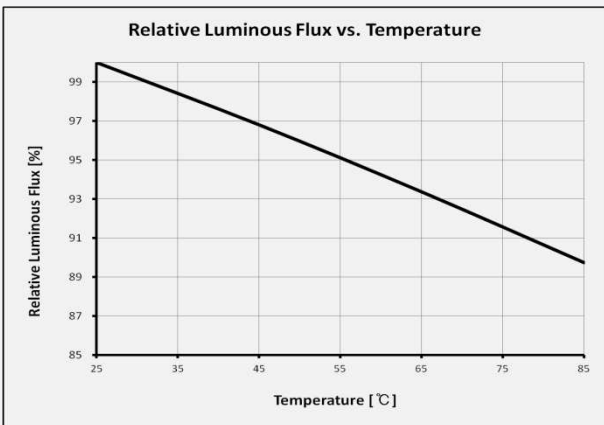

d) Color Shift Characteristics ($I_f = 150 \text{ mA}$, $T_s = 25 \text{ }^\circ\text{C}$)

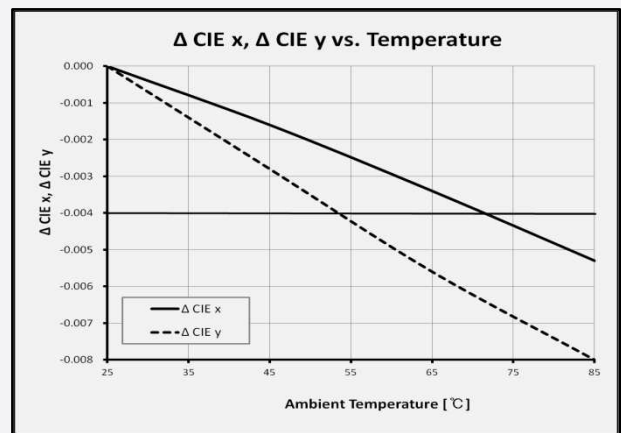
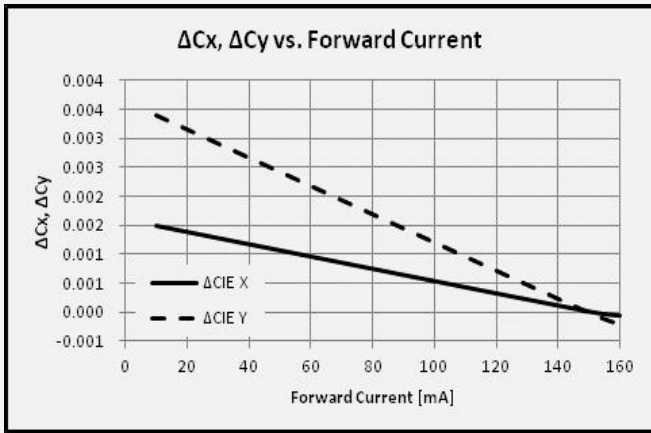

e) Derating Curve

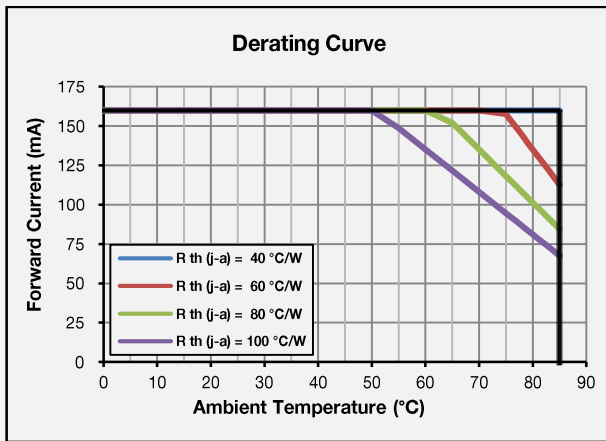

f) Beam Angle Characteristics ($I_f = 150 \text{ mA}$, $T_s = 25 \text{ }^\circ\text{C}$)

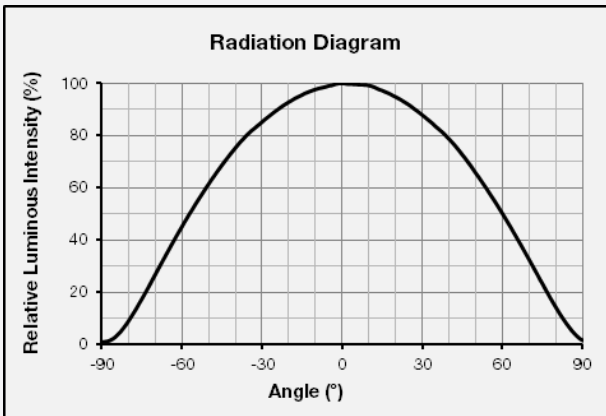

4. Outline Drawing & Dimension

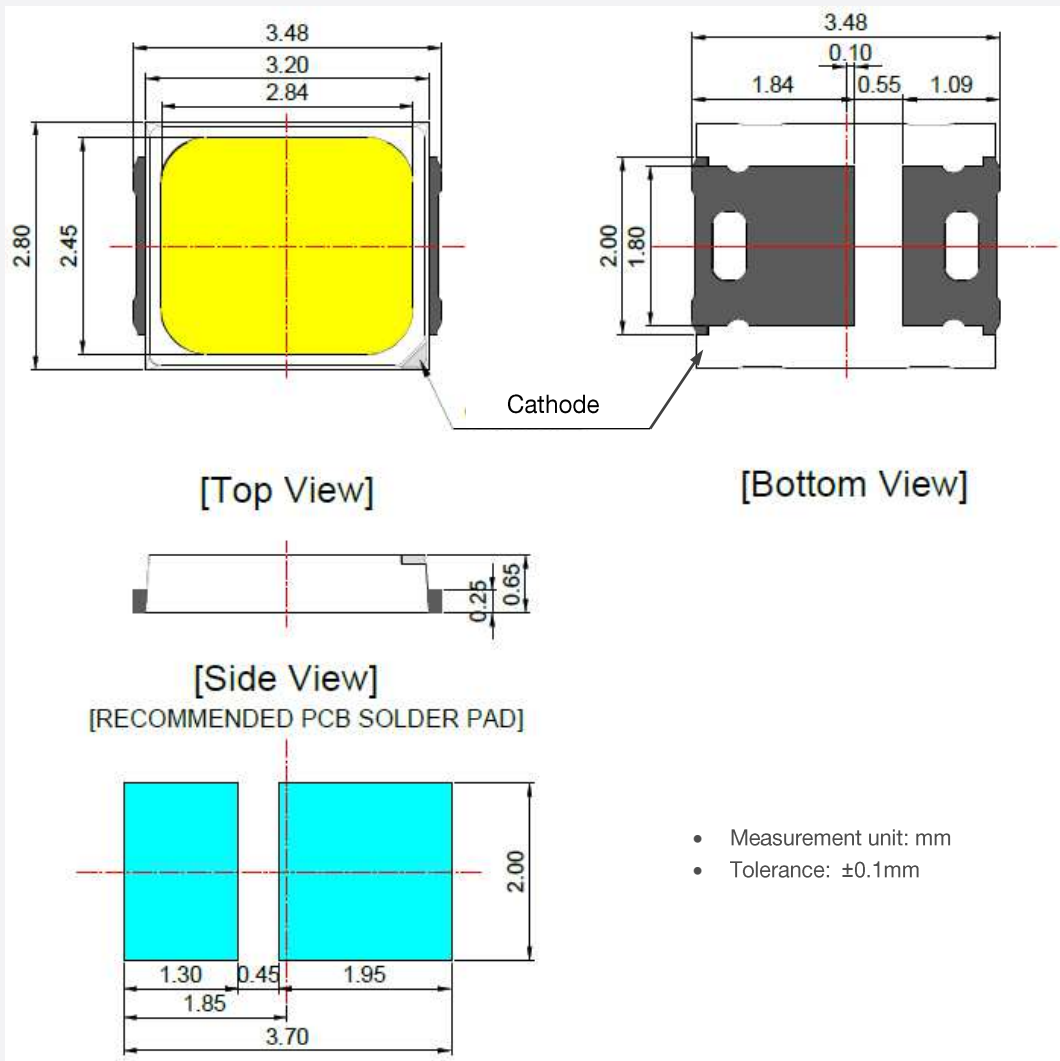

Notes:

- 1) T_s point and measurement method:
 - ① Measure one point at the cathode pad, if necessary remove PSR of PCB to reach T_s point.
 - ② All pads must be soldered to the PCB to dissipate heat properly, otherwise the LED can be damaged.

Precautions:

- 1) Pressure on the LEDs will influence to the reliability of the LEDs. Precautions should be taken to avoid strong pressure on the LEDs. Do not put stress on the LEDs during heating.
- 2) Re-soldering should not be done after the LEDs have been soldered. If re-soldering is unavoidable, LED's characteristics should be carefully checked before and after such repair.
- 3) Do not stack assembled PCBs together. Since materials of LEDs is soft, abrasion between two PCB assembled with LED might cause catastrophic failure of the LEDs.

5. Reliability Test Items & Conditions

a) Test Items

Test Item	Test Condition	Test Hour / Cycle	Sample No.
Room Temperature Life Test	25 °C, DC 160 mA	1000 h	22
High Temperature Life Test	85 °C, DC 160 mA	1000 h	22
High Temperature Humidity Life Test	85 °C, 85 % RH, DC 160 mA	1000 h	22
Low Temperature Life Test	-40 °C, DC 160 mA	1000 h	22
Powered Temperature Cycle Test	-45 °C ~ 85 °C, each 20 min, on/off 5 min Temp. Change time 100min, DC 160 mA	100 cycles	22
Temperature Cycle	-45°C / 15 min ↔ 125 °C / 15 min	200 cycles	100
High Temperature Storage	85 °C	1000 h	11
Low Temperature Storage	-40 °C	1000 h	11

ESD (HBM)

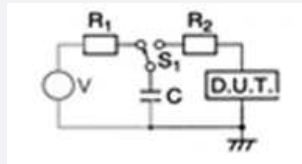

R_1 : 10 M Ω
 R_2 : 1.5 k Ω
 C : 100 pF
 V : ± 2 kV

5 times

30

b) Criteria for Judging the Damage

Item	Symbol	Test Condition ($T_s = 25$ °C)	Limit	
			Min	Max
Forward Voltage	V_F	$I_F = 150$ mA	Init. Value * 0.9	Init. Value * 1.1
Luminous Flux	Φ_v	$I_F = 150$ mA	Init. Value * 0.7	Init. Value * 1.1

6. Soldering Conditions

a) Reflow Conditions (Pb free)

Reflow frequency: 2 times max.

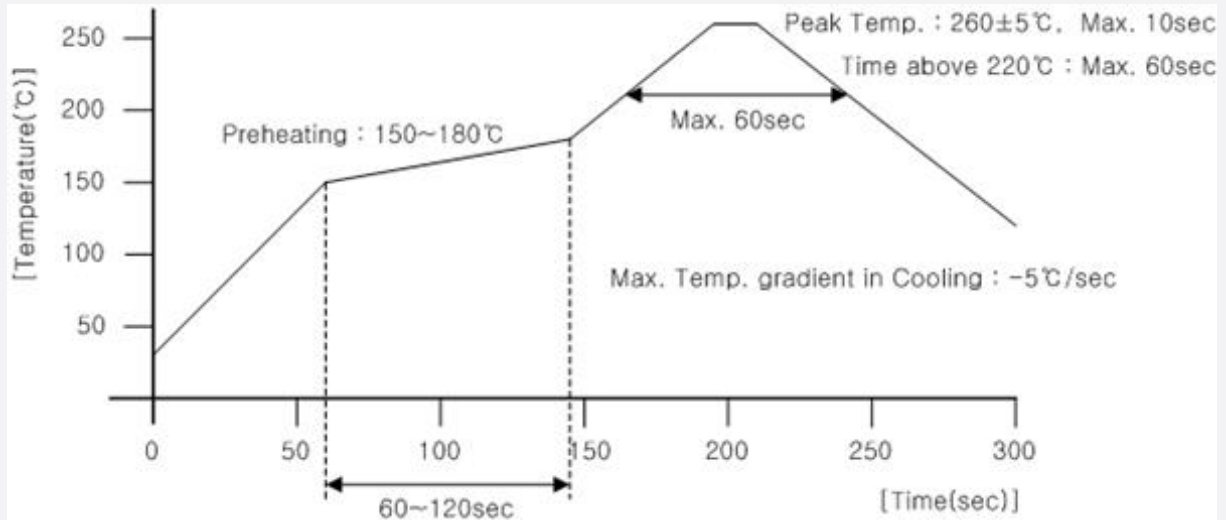

b) Manual Soldering Conditions

Not more than 5 seconds @ max. 300 °C, under soldering iron.

7. Tape & Reel

a) Taping Dimension

(unit: mm)

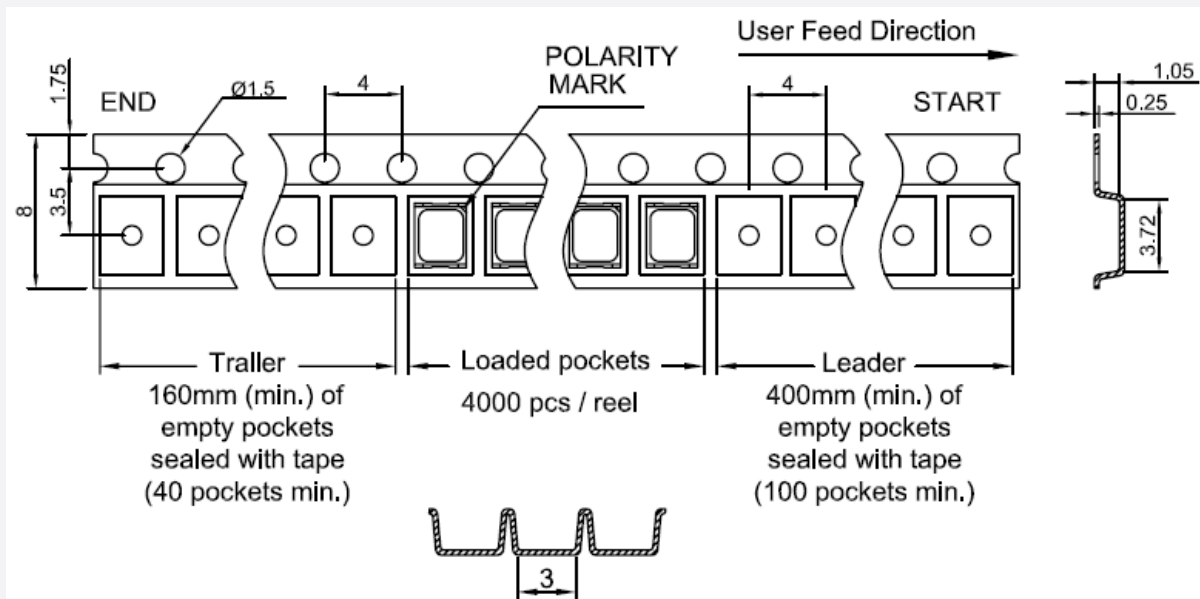

b) Reel Dimension (max 4,000 pcs)

(unit: mm)

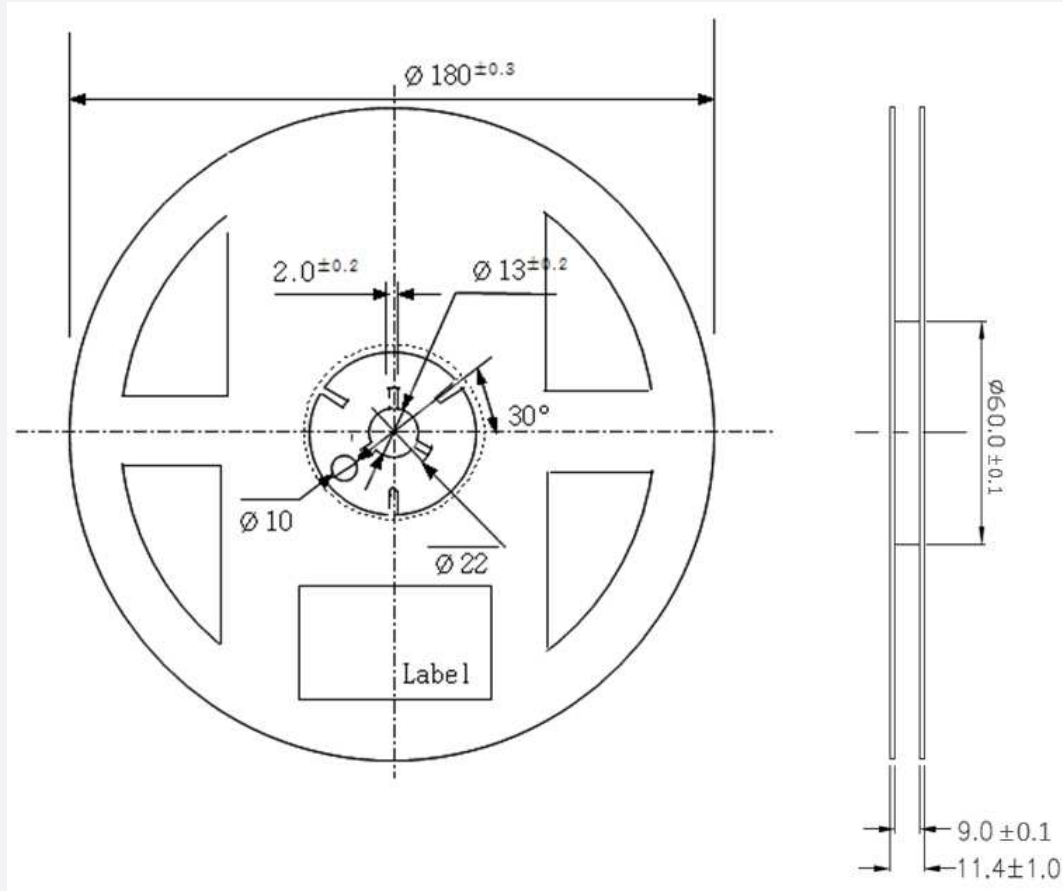
**Notes:**

- 1) Quantity: The quantity/reel is 4,000 pcs
- 2) All dimensions are millimeters (tolerance : $\pm 0.2\text{mm}$)
- 3) Packaging: P/N, Manufacturing data code no. and quantity are indicated on the aluminum packing bag

c) Reel Dimension (max 12,000 pcs)

(unit: mm)

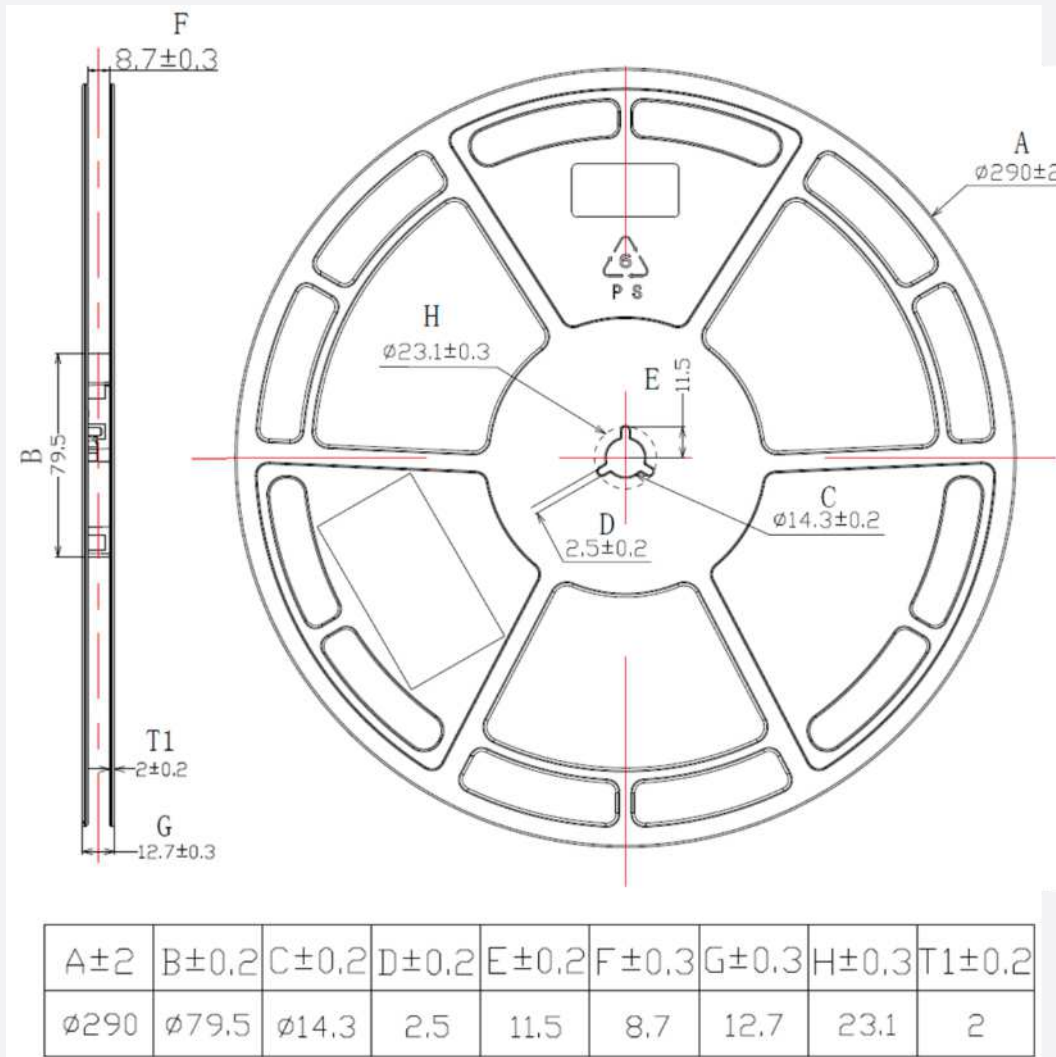

Notes:

- 1) Quantity: The quantity/reel is 12,000 pcs
- 2) All dimensions are millimeters (tolerance : ±0.2mm)
- 3) Packaging: P/N, Manufacturing data code no. and quantity are indicated on the aluminum packing bag

8. Label Structure

a) Label Structure

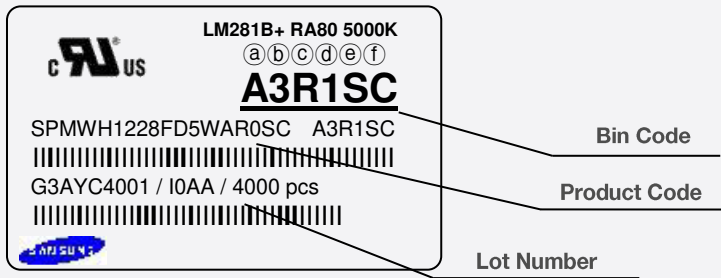

Note: Denoted bin code and product code above is only an example (see description on page 6)

Bin Code:

- ⒶⒷ: Forward Voltage bin (refer to page 10)
- ⒸⒹ: Chromaticity bin (refer to page 11-18)
- ⒺⒻ: Luminous Flux bin (refer to page 7)

b) Lot Number

The lot number is composed of the following characters:



①②③④⑤⑥⑦⑧⑨ / IⒶⒷⒸ / 4,000 pcs

- ① : Production site (S: Giheung, Korea, G: Tianjin, China)
- ② : 3 or P (LED)
- ③ : Product state (A: Normal, B: Bulk, C: First Production, R: Reproduction, S: Sample)
- ④ : Year (Z: 2015, A: 2016, B: 2017...)
- ⑤ : Month (1~9, A, B, C)
- ⑥ : Day (1~9, A, B~V)
- ⑦⑧⑨ ⒶⒷⒸ : Product serial number