



Chipsmall Limited consists of a professional team with an average of over 10 year of expertise in the distribution of electronic components. Based in Hongkong, we have already established firm and mutual-benefit business relationships with customers from,Europe,America and south Asia,supplying obsolete and hard-to-find components to meet their specific needs.

With the principle of "Quality Parts,Customers Priority,Honest Operation,and Considerate Service",our business mainly focus on the distribution of electronic components. Line cards we deal with include Microchip,ALPS,ROHM,Xilinx,Pulse,ON,Everlight and Freescale. Main products comprise IC,Modules,Potentiometer,IC Socket,Relay,Connector.Our parts cover such applications as commercial,industrial, and automotives areas.

We are looking forward to setting up business relationship with you and hope to provide you with the best service and solution. Let us make a better world for our industry!



## Contact us

Tel: +86-755-8981 8866 Fax: +86-755-8427 6832

Email & Skype: info@chipsmall.com Web: www.chipsmall.com

Address: A1208, Overseas Decoration Building, #122 Zhenhua RD., Futian, Shenzhen, China



Middle Power LED Series  
3030

# LM302A CRI 90

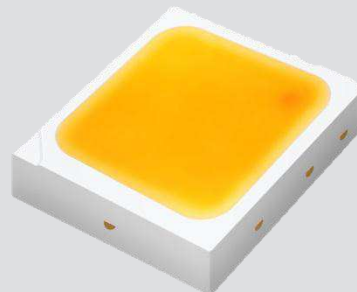

LM302A leads lighting design trend with high performance and efficacy

## Features & Benefits

- 1 W class middle-high power LED
- EMC resin for high reliability
- Standard form factor for design flexibility
- High performance and efficacy



## Table of Contents

1.	Characteristics	-----	3
2.	Product Code Information	-----	5
3.	Typical Characteristics Graphs	-----	14
4.	Outline Drawing & Dimension	-----	18
5.	Reliability Test Items & Conditions	-----	20
6.	Soldering Conditions	-----	21
7.	Tape & Reel	-----	22
8.	Label Structure	-----	24
9.	Packing Structure	-----	25
10.	Precautions in Handling & Use	-----	27

## 1. Characteristics

### a) Absolute Maximum Rating

Item	Symbol	Rating	Unit	Condition
Operating Temperature	$T_a$	-40 ~ +85	°C	-
Storage Temperature	$T_{stg}$	-40 ~ +100	°C	-
LED Junction Temperature	$T_j$	125	°C	-
Forward Current	$I_F$	200	mA	-
Assembly Process Temperature	-	260 <10	°C s	-
ESD (HBM)	-	5	kV	-

**b) Electro-optical Characteristics (I<sub>F</sub> = 150 mA, T<sub>s</sub> = 85 °C)**

Item	Nominal CCT (K)	Rank	Bin	Min.	Typ.	Max.	Unit
Forward Voltage (V <sub>F</sub> )		YB	BY	5.6	-	5.8	V
			BZ	5.8	-	6.0	
			B1	6.0	-	6.2	
			B2	6.2	-	6.4	
			B3	6.4	-	6.6	
Luminous Flux (Φ <sub>v</sub> )	2700	S0	S1	80.0	-	88.0	lm
			S2	88.0	-	96.0	
	3000	S0	S1	85.0	-	93.0	
			S2	93.0	-	101.0	
	3500	S0	S1	86.8	-	94.8	
			S2	94.8	-	102.8	
	4000	S0	S1	88.6	-	96.6	
			S2	96.6	-	104.6	
	5000	S0	S1	86.8	-	94.8	
			S2	94.8	-	102.8	
	5700	S0	S1	85.0	-	93.0	
			S2	93.0	-	101.0	
	6500	S0	S1	83.2	-	91.2	
			S2	91.2	-	99.2	
Reverse Voltage (@ 5 mA)				0.7	-	1.2	V
Color Rendering Index (R <sub>a</sub> )				90	-	-	-
Special CRI (R9)				50	-	-	-
Thermal Resistance (junction to solder point)				-	12	-	°C/W
Beam Angle				-	120	-	°

**Note:**

Samsung maintains measurement tolerance of: forward voltage = ±0.1 V, luminous flux = ±5 %, CRI = ±3, R9 = ±6.5

## 2. Product Code Information

1	2	3	4	5	6	7	8	9	10	11	12	13	14	15	16	17	18
S	P	M	W	H	T	3	2	7	F	D	7	Y	B	W	0	S	0

Digit	PKG Information	Code	Specification
1 2 3	Samsung Package Middle Power	<b>SPM</b>	
4 5	Color	<b>WH</b>	White
6	Product Version	<b>T</b>	
7 8 9	Form Factor	<b>327</b>	3.0 x 3.0 x 0.65 mm; 2 pads; 2 chips
10	Sorting Current	<b>F</b>	150 mA
11	Chromaticity Coordinates	<b>D</b>	ANSI Standard
12	CRI	<b>7</b>	Min. 90
13 14	Forward Voltage (V)	<b>YB</b>	5.6~6.6 Bin Code: <b>BY</b> 5.6~5.8 <b>BZ</b> 5.8~6.0 <b>B1</b> 6.0~6.2 <b>B2</b> 6.2~6.4 <b>B3</b> 6.4~6.6
15 16	CCT (K)	<b>W</b> ☆ <b>V</b> ☆ <b>U</b> ☆ <b>T</b> ☆ <b>R0</b> <b>Q0</b> <b>P0</b>	2700 3000 3500 4000 5000 5700 6500 W1, W2, W3, W4, W5, W6, W7, W8, W9, WA, WB, WC, WD, WE, WF, WG V1, V2, V3, V4, V5, V6, V7, V8, V9, VA, VB, VC, VD, VE, VF, VG U1, U2, U3, U4, U5, U6, U7, U8, U9, UA, UB, UC, UD, UE, UF, UG T1, T2, T3, T4, T5, T6, T7, T8, T9, TA, TB, TC, TD, TE, TF, TG R1, R2, R3, R4, R7, R8 Q1, Q2, Q3, Q4, Q7, Q8 P1, P2, P3, P4, P7, P8 ☆ : "0" (Whole bin) or "M" (Quarter bin)
17 18	Luminous Flux (lm)	<b>S0</b>	Bin Code: S1, S2

**a) Luminous Flux Bins ( $I_F = 150 \text{ mA}$ ,  $T_s = 85 \text{ }^\circ\text{C}$ )**

Nominal CCT (K)	CRI Min.	Product Code	Flux Bin	Flux Range ( $\Phi_v$ , lm)
2700	90	SPMWHT327FD7YBW☆S0	S1	80.0 ~ 88.0
			S2	88.0 ~ 96.0
3000	90	SPMWHT327FD7YBV☆S0	S1	85.0 ~ 93.0
			S2	93.0 ~ 101.0
3500	90	SPMWHT327FD7YBU☆S0	S1	86.8 ~ 94.8
			S2	94.8 ~ 102.8
4000	90	SPMWHT327FD7YBT☆S0	S1	88.6 ~ 96.6
			S2	96.6 ~ 104.6
5000	90	SPMWHT327FD7YBR0S0	S1	86.8 ~ 94.8
			S2	94.8 ~ 102.8
5700	90	SPMWHT327FD7YBQ0S0	S1	85.0 ~ 93.0
			S2	93.0 ~ 101.0
6500	90	SPMWHT327FD7YBP0S0	S1	83.2 ~ 91.2
			S2	91.2 ~ 99.2

**Note:**

"☆" can be "0" (Whole bin) or "M" (Quarter bin) of the color binning

b) Color Bins ( $I_F = 150 \text{ mA}$ ,  $T_s = 85 \text{ }^\circ\text{C}$ )

Nominal CCT (K)	CRI Min.	Product Code	Color Rank	Chromaticity Bins
2700	90	SPMWHT327FD7YBW0S0	W0	W1, W2, W3, W4, W5, W6, W7, W8,
			(Whole bin)	W9, WA, WB, WC, WD, WE, WF, WG
3000	90	SPMWHT327FD7YBVM0S0	WM	W6, W7, WA, WB
			(Quarter bin)	
3500	90	SPMWHT327FD7YBU0S0	V0	V1, V2, V3, V4, V5, V6, V7, V8,
			(Whole bin)	V9, VA, VB, VC, VD, VE, VF, VG
4000	90	SPMWHT327FD7YBUMS0	VM	V6, V7, VA, VB
			(Quarter bin)	
5000	90	SPMWHT327FD7YBT0S0	U0	U1, U2, U3, U4, U5, U6, U7, U8,
			(Whole bin)	U9, UA, UB, UC, UD, UE, UF, UG
5700	90	SPMWHT327FD7YBTMS0	UM	U6, U7, UA, UB
			(Quarter bin)	
6500	90	SPMWHT327FD7YBR0S0	T0	T1, T2, T3, T4, T5, T6, T7, T8,
			(Whole bin)	T9, TA, TB, TC, TD, TE, TF, TG
6500	90	SPMWHT327FD7YBQ0S0	TM	T6, T7, TA, TB
			(Quarter bin)	
6500	90	SPMWHT327FD7YBP0S0	R0	R1, R2, R3
			(Whole bin)	R4, R7, R8
6500	90	SPMWHT327FD7YBQ0S0	Q0	Q1, Q2, Q3
			(Whole bin)	Q4, Q7, Q8
6500	90	SPMWHT327FD7YBP0S0	P0	P1, P2, P3,
			(Whole bin)	P4, P7, P8



c) Voltage Bins ( $I_f = 150 \text{ mA}$ ,  $T_s = 85 \text{ °C}$ )

Nominal CCT (K)	CRI Min.	Product Code	Voltage Rank	Voltage Bin	Voltage Range (V)
-	-	-	YB	BY	5.6 ~ 5.8
				BZ	5.8 ~ 6.0
				B1	6.0 ~ 6.2
				B2	6.2 ~ 6.4
				B3	6.4 ~ 6.6

d) Chromaticity Region & Coordinates ( $I_f = 150 \text{ mA}$ ,  $T_s = 85^\circ\text{C}$ )

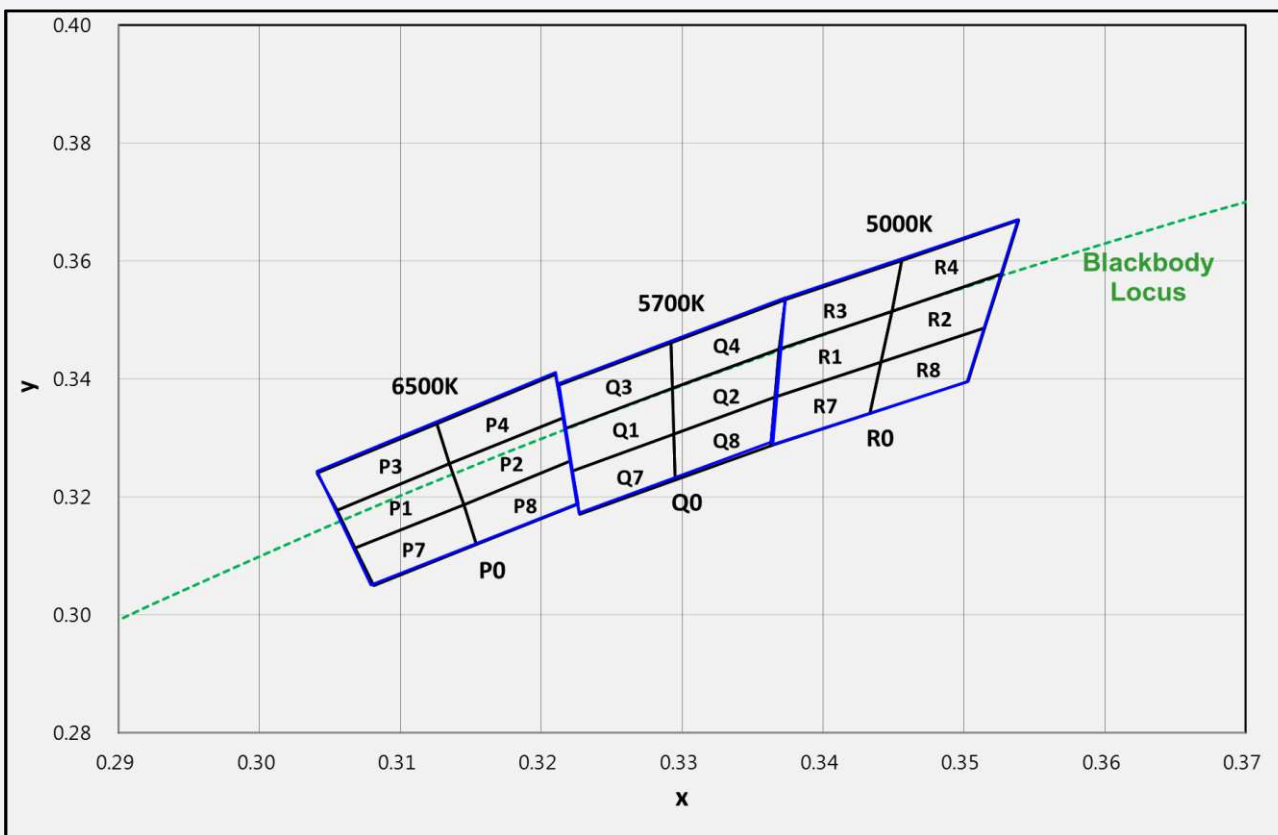
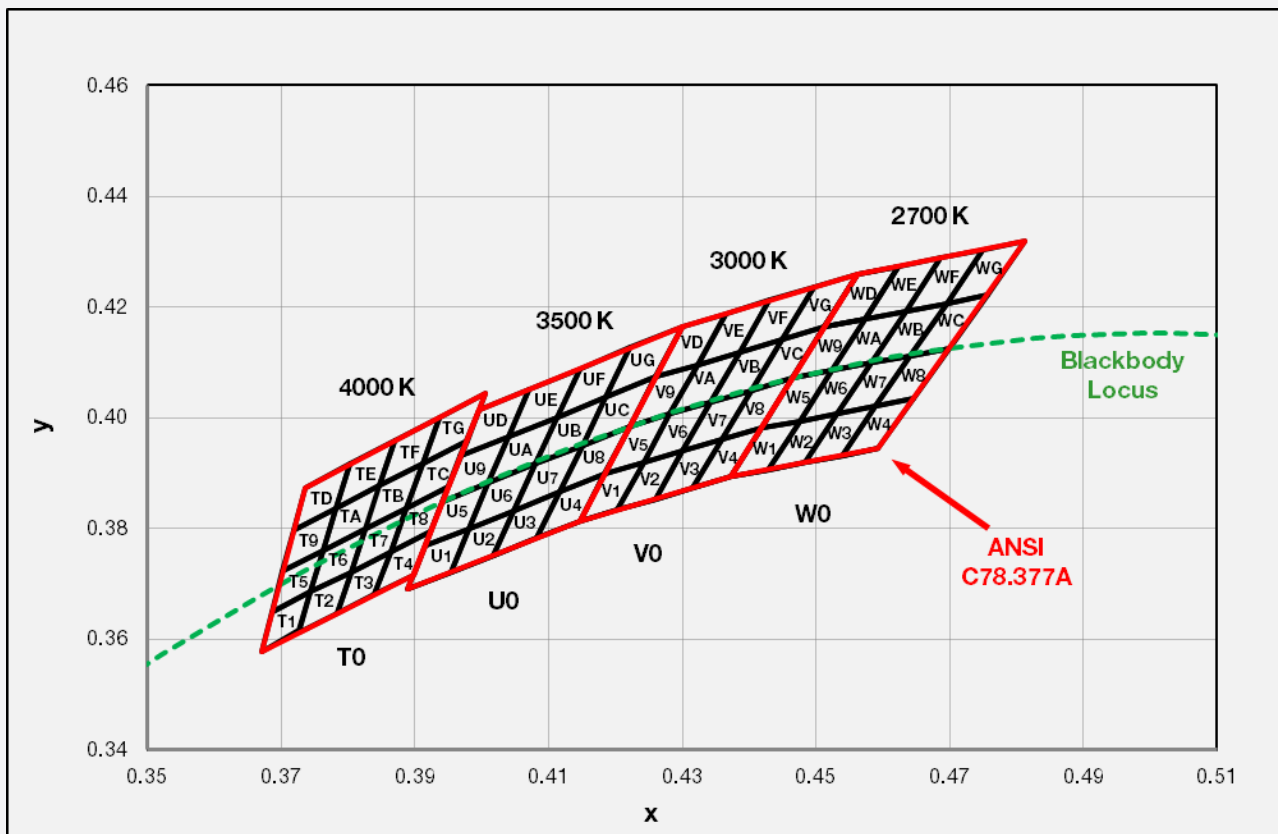

**d) Chromaticity Region & Coordinates ( $I_F = 150 \text{ mA}$ ,  $T_s = 85 \text{ }^\circ\text{C}$ )**

Region	CIE x	CIE y	Region	CIE x	CIE y
<b>W rank (2700 K)</b>					
W1	0.4373	0.3893	W9	0.4465	0.4071
	0.4418	0.3981		0.4513	0.4164
	0.4475	0.3994		0.4573	0.4178
	0.4428	0.3906		0.4523	0.4085
W2	0.4428	0.3906	WA	0.4523	0.4085
	0.4475	0.3994		0.4573	0.4178
	0.4532	0.4008		0.4634	0.4193
	0.4483	0.3919		0.4582	0.4099
W3	0.4483	0.3919	WB	0.4582	0.4099
	0.4532	0.4008		0.4634	0.4193
	0.4589	0.4021		0.4695	0.4207
	0.4538	0.3931		0.4641	0.4112
W4	0.4538	0.3931	WC	0.4641	0.4112
	0.4589	0.4021		0.4695	0.4207
	0.4646	0.4034		0.4756	0.4221
	0.4593	0.3944		0.4700	0.4126
W5	0.4418	0.3981	WD	0.4513	0.4164
	0.4465	0.4071		0.4562	0.4260
	0.4523	0.4085		0.4624	0.4274
	0.4475	0.3994		0.4573	0.4178
W6	0.4475	0.3994	WE	0.4573	0.4178
	0.4523	0.4085		0.4624	0.4274
	0.4582	0.4099		0.4687	0.4289
	0.4532	0.4008		0.4634	0.4193
W7	0.4532	0.4008	WF	0.4634	0.4193
	0.4582	0.4099		0.4687	0.4289
	0.4641	0.4112		0.4750	0.4304
	0.4589	0.4021		0.4695	0.4207
W8	0.4589	0.4021	WG	0.4695	0.4207
	0.4641	0.4112		0.4750	0.4304
	0.4700	0.4126		0.4813	0.4319
	0.4646	0.4034		0.4756	0.4221

Region	CIE x	CIE y	Region	CIE x	CIE y
<b>V rank (3000 K)</b>					
V1	0.4147	0.3814	V9	0.4221	0.3984
	0.4183	0.3898		0.4259	0.4073
	0.4242	0.3919		0.4322	0.4096
	0.4203	0.3833		0.4281	0.4006
V2	0.4203	0.3833	VA	0.4281	0.4006
	0.4242	0.3919		0.4322	0.4096
	0.4300	0.3939		0.4385	0.4119
	0.4259	0.3853		0.4342	0.4028
V3	0.4259	0.3853	VB	0.4342	0.4028
	0.4300	0.3939		0.4385	0.4119
	0.4359	0.3960		0.4449	0.4141
	0.4316	0.3873		0.4403	0.4049
V4	0.4316	0.3873	VC	0.4403	0.4049
	0.4359	0.3960		0.4449	0.4141
	0.4418	0.3981		0.4513	0.4164
	0.4373	0.3893		0.4465	0.4071
V5	0.4183	0.3898	VD	0.4259	0.4073
	0.4221	0.3984		0.4299	0.4165
	0.4281	0.4006		0.4364	0.4188
	0.4242	0.3919		0.4322	0.4096
V6	0.4242	0.3919	VE	0.4322	0.4096
	0.4281	0.4006		0.4364	0.4188
	0.4342	0.4028		0.4430	0.4212
	0.4300	0.3939		0.4385	0.4119
V7	0.4300	0.3939	VF	0.4385	0.4119
	0.4342	0.4028		0.4430	0.4212
	0.4403	0.4049		0.4496	0.4236
	0.4359	0.3960		0.4449	0.4141
V8	0.4359	0.3960	VG	0.4449	0.4141
	0.4403	0.4049		0.4496	0.4236
	0.4465	0.4071		0.4562	0.4260
	0.4418	0.3981		0.4513	0.4164

## d) Chromaticity Region &amp; Coordinates

Region	CIE x	CIE y	Region	CIE x	CIE y
<b>U rank (3500 K)</b>					
U1	0.3889	0.3690	U9	0.3941	0.3848
	0.3915	0.3768		0.3968	0.3930
	0.3981	0.3800		0.4040	0.3966
	0.3953	0.3720		0.4010	0.3882
U2	0.3953	0.3720	UA	0.4010	0.3882
	0.3981	0.3800		0.4040	0.3966
	0.4048	0.3832		0.4113	0.4001
	0.4017	0.3751		0.4080	0.3916
U3	0.4017	0.3751	UB	0.4080	0.3916
	0.4048	0.3832		0.4113	0.4001
	0.4116	0.3865		0.4186	0.4037
	0.4082	0.3782		0.4150	0.3950
U4	0.4082	0.3782	UC	0.4150	0.3950
	0.4116	0.3865		0.4186	0.4037
	0.4183	0.3898		0.4259	0.4073
	0.4147	0.3814		0.4221	0.3984
U5	0.3915	0.3768	UD	0.3968	0.3930
	0.3941	0.3848		0.3996	0.4015
	0.4010	0.3882		0.4071	0.4052
	0.3981	0.3800		0.4040	0.3966
U6	0.3981	0.3800	UE	0.4040	0.3966
	0.4010	0.3882		0.4071	0.4052
	0.4080	0.3916		0.4146	0.4089
	0.4048	0.3832		0.4113	0.4001
U7	0.4048	0.3832	UF	0.4113	0.4001
	0.4080	0.3916		0.4146	0.4089
	0.4150	0.3950		0.4222	0.4127
	0.4116	0.3865		0.4186	0.4037
U8	0.4116	0.3865	UG	0.4186	0.4037
	0.4150	0.3950		0.4222	0.4127
	0.4221	0.3984		0.4299	0.4165
	0.4183	0.3898		0.4259	0.4073

Region	CIE x	CIE y	Region	CIE x	CIE y
<b>T rank (4000 K)</b>					
T1	0.3670	0.3578	T9	0.3702	0.3722
	0.3726	0.3612		0.3763	0.3760
	0.3744	0.3685		0.3782	0.3837
	0.3686	0.3649		0.3719	0.3797
T2	0.3726	0.3612	TA	0.3763	0.3760
	0.3783	0.3646		0.3825	0.3798
	0.3804	0.3721		0.3847	0.3877
	0.3744	0.3685		0.3782	0.3837
T3	0.3783	0.3646	TB	0.3825	0.3798
	0.3840	0.3681		0.3887	0.3836
	0.3863	0.3758		0.3912	0.3917
	0.3804	0.3721		0.3847	0.3877
T4	0.3840	0.3681	TC	0.3887	0.3837
	0.3898	0.3716		0.3950	0.3875
	0.3924	0.3794		0.3978	0.3958
	0.3863	0.3758		0.3912	0.3917
T5	0.3686	0.3649	TD	0.3719	0.3797
	0.3744	0.3685		0.3782	0.3837
	0.3763	0.3760		0.3802	0.3916
	0.3702	0.3722		0.3736	0.3874
T6	0.3744	0.3685	TE	0.3782	0.3837
	0.3804	0.3721		0.3847	0.3877
	0.3825	0.3798		0.3869	0.3958
	0.3763	0.376		0.3802	0.3916
T7	0.3804	0.3721	TF	0.3847	0.3877
	0.3863	0.3758		0.3912	0.3917
	0.3887	0.3836		0.3937	0.4001
	0.3825	0.3798		0.3869	0.3958
T8	0.3863	0.3758	TG	0.3912	0.3917
	0.3924	0.3794		0.3978	0.3958
	0.3950	0.3875		0.4006	0.4044
	0.3887	0.3836		0.3937	0.4001

## d) Chromaticity Region &amp; Coordinates

Region	CIE x	CIE y	Region	CIE x	CIE y
<b>R rank (5000 K)</b>					
R1	0.3366	0.3369	R4	0.3449	0.3515
	0.3441	0.3428		0.3527	0.3578
	0.3449	0.3515		0.3539	0.3669
	0.3369	0.3451		0.3456	0.3601
R2	0.3441	0.3428	R7	0.3363	0.3287
	0.3515	0.3487		0.3433	0.3341
	0.3527	0.3578		0.3441	0.3428
	0.3449	0.3515		0.3366	0.3369
R3	0.3369	0.3451	R8	0.3433	0.3341
	0.3449	0.3515		0.3503	0.3396
	0.3456	0.3601		0.3515	0.3487
	0.3373	0.3534		0.3441	0.3428

Region	CIE x	CIE y	Region	CIE x	CIE y
<b>Q rank (5700 K)</b>					
Q1	0.3222	0.3243	Q4	0.3293	0.3384
	0.3294	0.3306		0.3369	0.3451
	0.3293	0.3384		0.3373	0.3534
	0.3217	0.3316		0.3292	0.3461
Q2	0.3294	0.3306	Q7	0.3227	0.3170
	0.3366	0.3369		0.3295	0.3228
	0.3369	0.3451		0.3294	0.3306
	0.3293	0.3384		0.3222	0.3243
Q3	0.3217	0.3316	Q8	0.3295	0.3228
	0.3293	0.3384		0.3363	0.3287
	0.3292	0.3461		0.3366	0.3369
	0.3212	0.3389		0.3294	0.3306

#### d) Chromaticity Region & Coordinates

Region	CIE x	CIE y	Region	CIE x	CIE y
<b>P rank (6500 K)</b>					
P1	0.3068	0.3113	P4	0.3135	0.3256
	0.3145	0.3187		0.3216	0.3334
	0.3135	0.3256		0.3210	0.3408
	0.3055	0.3177		0.3126	0.3324
P2	0.3145	0.3187	P7	0.3081	0.3049
	0.3221	0.3261		0.3154	0.3119
	0.3216	0.3334		0.3145	0.3187
	0.3135	0.3256		0.3068	0.3113
P3	0.3055	0.3177	P8	0.3154	0.3119
	0.3135	0.3256		0.3226	0.3188
	0.3126	0.3324		0.3221	0.3261
	0.3041	0.3240		0.3145	0.3187

**Note:**

Samsung maintains measurement tolerance of:  $C_x, C_y = \pm 0.005$

### 3. Typical Characteristics Graphs

#### a) Spectrum Distribution ( $I_f = 150 \text{ mA}$ , $T_s = 85 \text{ }^\circ\text{C}$ )

CCT: 2700 K

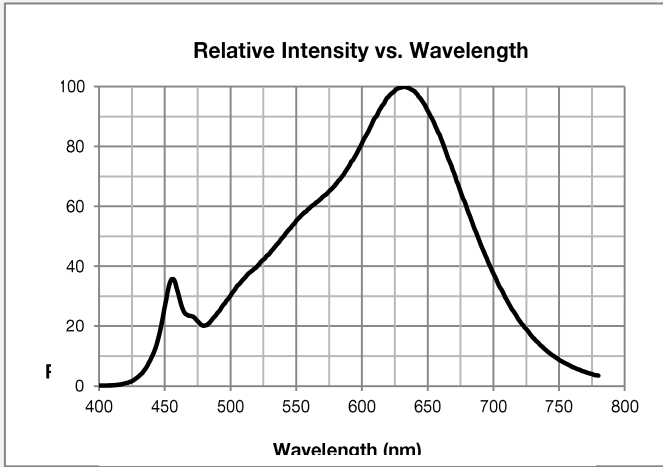

CCT: 3000 K

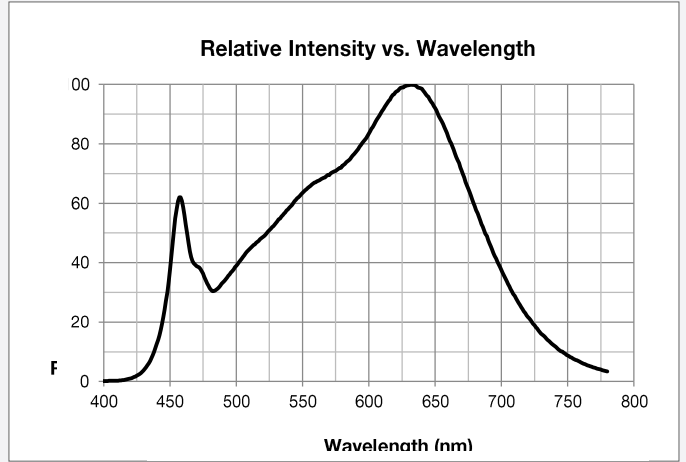

CCT: 3500 K

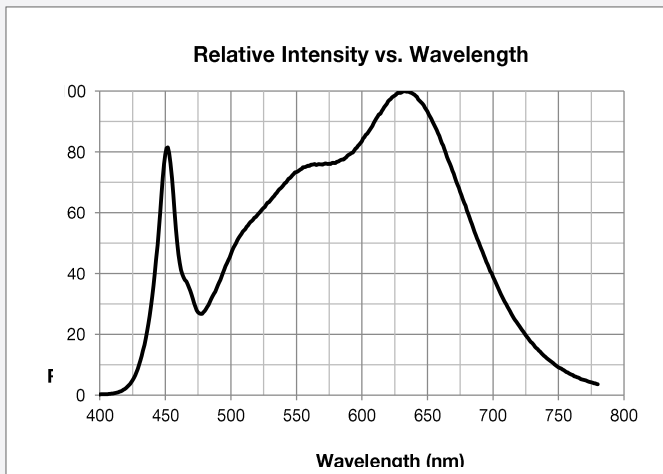

CCT: 4000 K

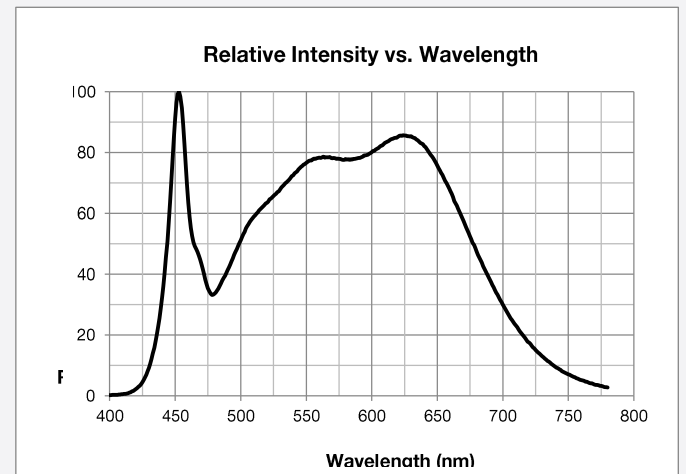

CCT: 5000 K

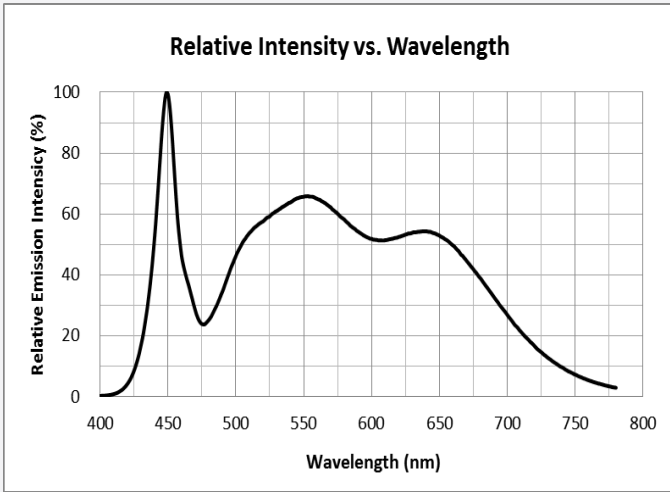

CCT: 5700 K

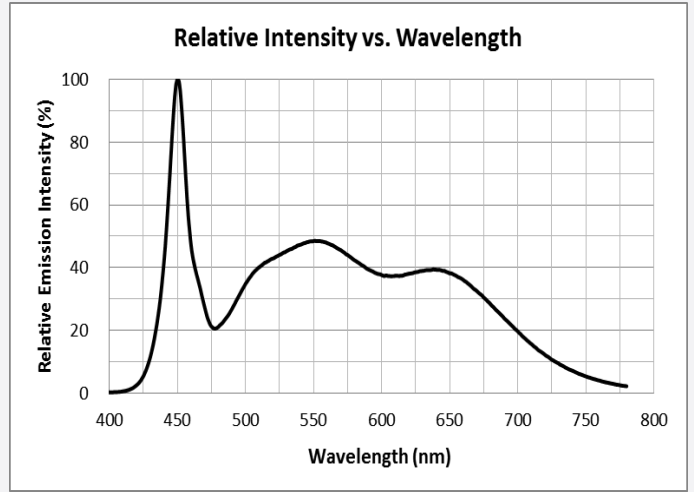

CCT: 6500K

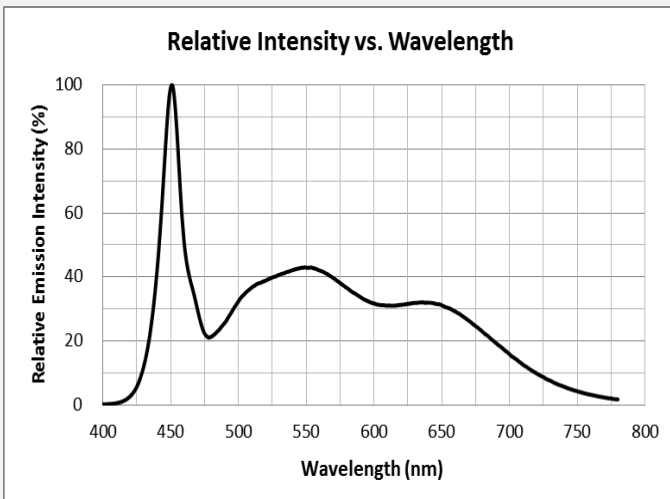



b) Forward Current Characteristics ( $T_s = 85^\circ\text{C}$ )

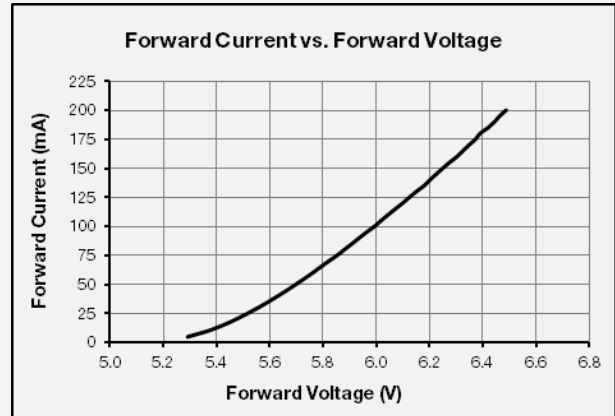
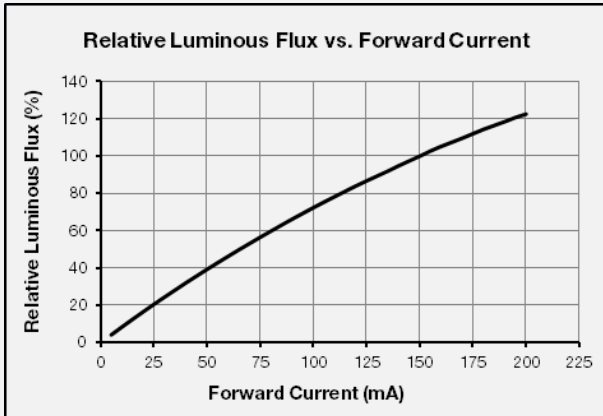

c) Temperature Characteristics ( $I_f = 150\text{ mA}$ )

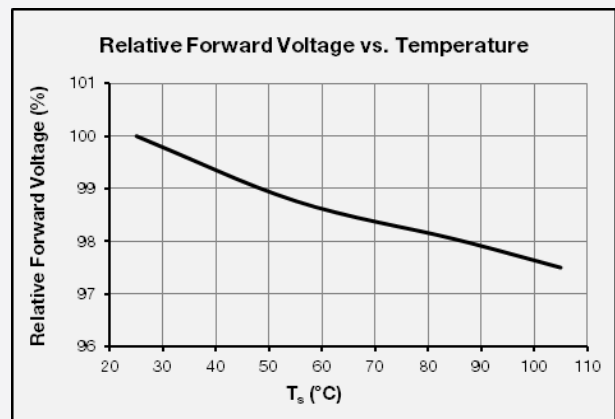
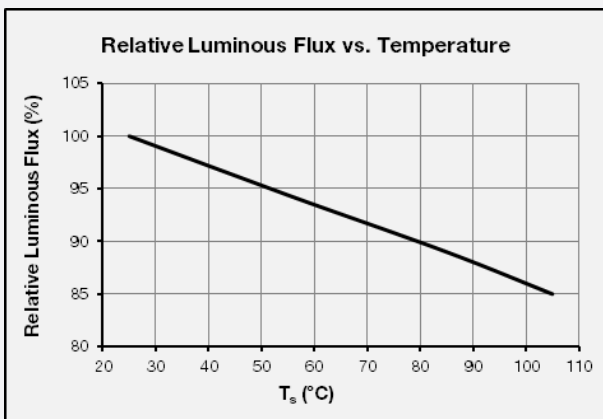

d) Color Shift Characteristics

$T_s = 85\text{ }^\circ\text{C}$

$I_F = 150\text{ mA}$

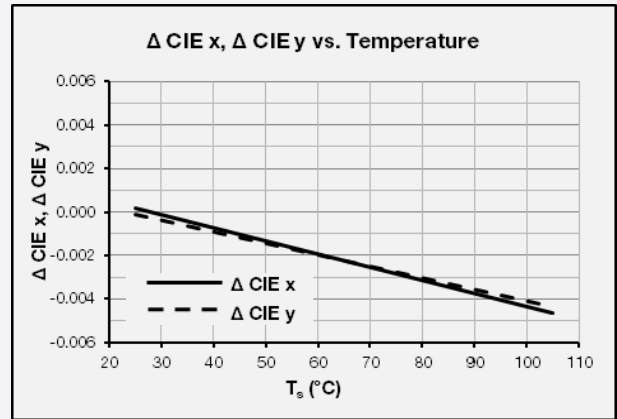
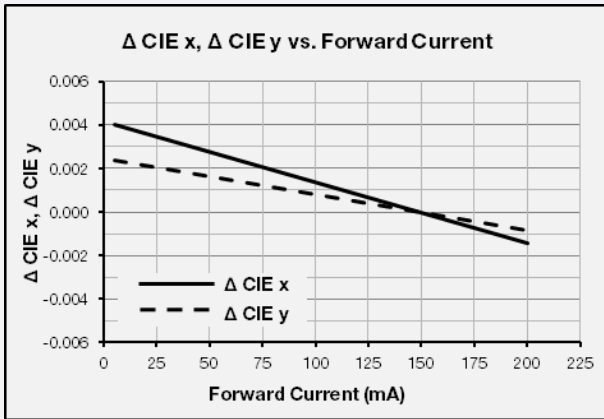

e) Derating Curve

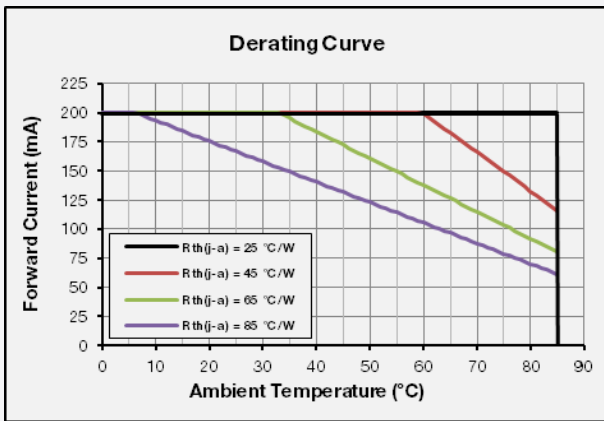

f) Beam Angle Characteristics ( $I_F = 150\text{ mA}$ ,  $T_s = 85\text{ }^\circ\text{C}$ )

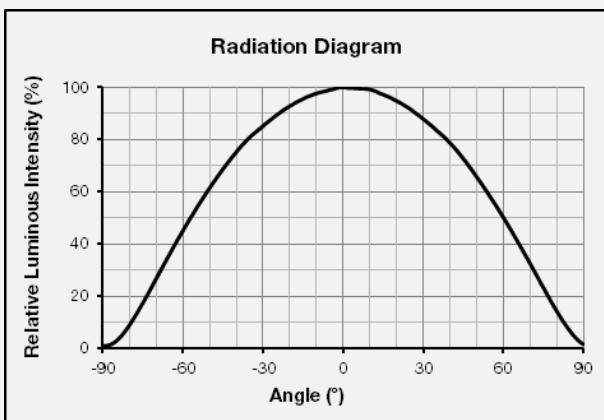

## 4. Outline Drawing & Dimension

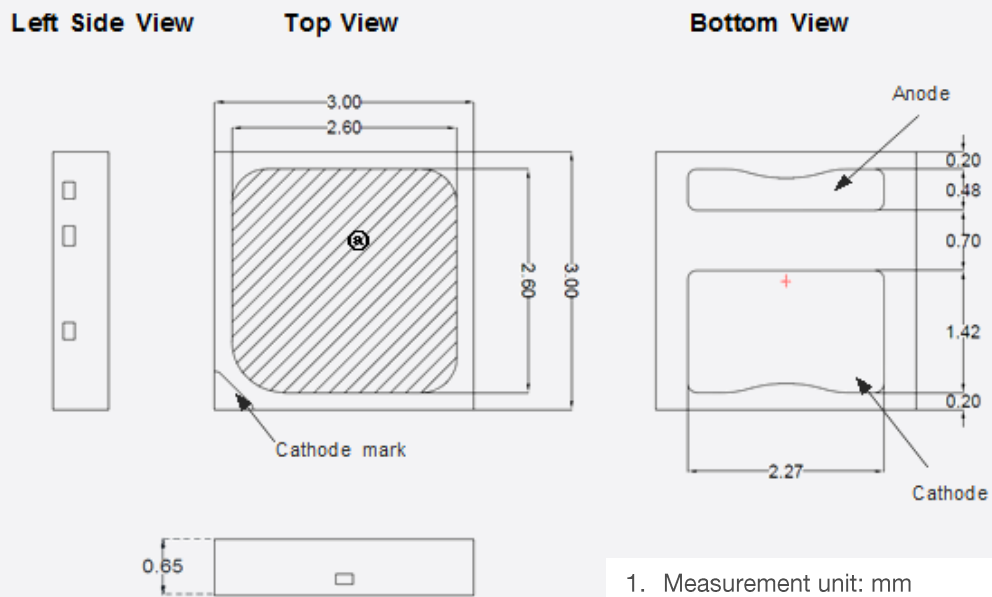

1. Measurement unit: mm
2. Tolerance:  $\pm 0.10$  mm
3. Do not place pressure on the encapsulation resin ①

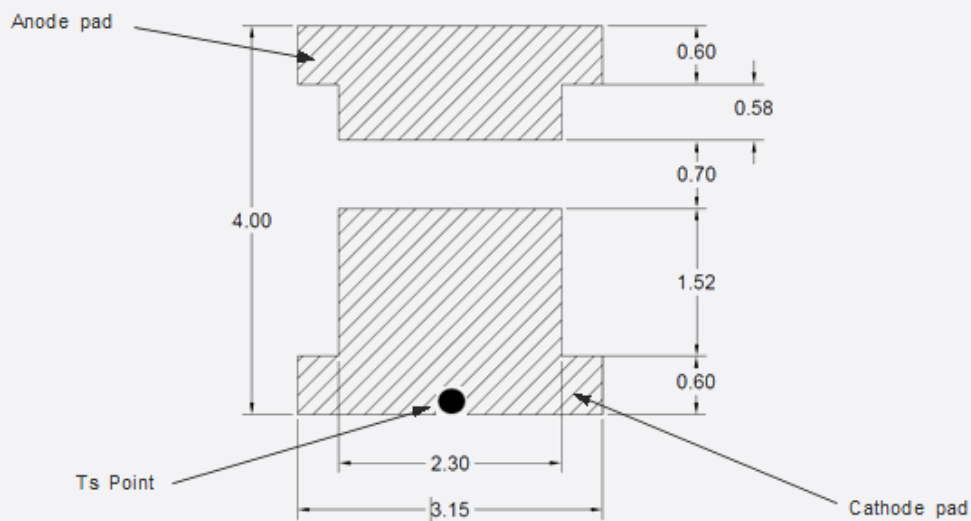

### Recommended Land Pattern

#### Notes:

- 1) This LED has built-in ESD protection device(s) connected in parallel to LED chip(s).
- 2)  $T_s$  point and measurement method:
  - ① Measure one point at the cathode pad. If necessary, remove PSR of PCB to reach  $T_s$  point.
  - ② All pads must be soldered to the PCB to dissipate heat properly, otherwise the LED can be damaged.

**Precautions:**

- 1) Pressure on the LEDs will influence to the reliability of the LEDs. Precautions should be taken to avoid strong pressure on the LEDs. Do not put stress on the LEDs during heating.
- 2) Re-soldering should not be done after the LEDs have been soldered. If re-soldering is unavoidable, LED's characteristics should be carefully checked before and after such repair.
- 3) Do not stack assembled PCBs together. Since materials of LEDs is soft, abrasion between two PCB assembled with LED might cause catastrophic failure of the LEDs.

## 5. Reliability Test Items and Conditions

### a) Test Items

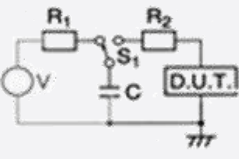
Test Item	Test Condition	Test Hour / Cycle	Sample Size	
Room Temperature Life Test	25 °C, DC 200 mA	1000 h	22	
High Temperature Life Test	85 °C, DC 200 mA	1000 h	22	
High Temperature Humidity Life Test	85 °C, 85 % RH, DC 200 mA	1000 h	22	
Low Temperature Life Test	-40 °C, DC 200 mA	1000 h	22	
Powered Temperature Cycle Test	-45 °C / 20 min ↔ 85 °C / 20 min, sweep 100 min cycle on/off: each 5 min, DC 200 mA	100 cycles	22	
Thermal Cycle	-45 °C / 15 min ↔ 125 °C / 15 min → Hot plate 180 °C	500 cycles	100	
High Temperature Storage	120 °C	1000 h	11	
Low Temperature Storage	-40 °C	1000 h	11	
ESD (HBM)		R <sub>1</sub> : 10 MΩ R <sub>2</sub> : 1.5 kΩ C: 100 pF V: ±5 kV	5 times	30
ESD (MM)				
Vibration Test	20~2000~20 Hz, 200 m/s <sup>2</sup> , sweep 4 min X, Y, Z 3 direction, each 1 cycle	4 cycles	11	
Mechanical Shock Test	1500 g, 0.5 ms 3 shocks each X-Y-Z axis	5 cycles	11	

### b) Criteria for Judging the Damage

Item	Symbol	Test Condition (T <sub>s</sub> = 25 °C)	Limit	
			Min.	Max.
Forward Voltage	V <sub>F</sub>	I <sub>F</sub> = 150 mA	Init. Value * 0.9	Init. Value * 1.1
Luminous Flux	Φ <sub>v</sub>	I <sub>F</sub> = 150 mA	Init. Value * 0.7	Init. Value * 1.1

## 6. Soldering Conditions

### a) Reflow Conditions (Pb free)

Reflow frequency: 2 times max.

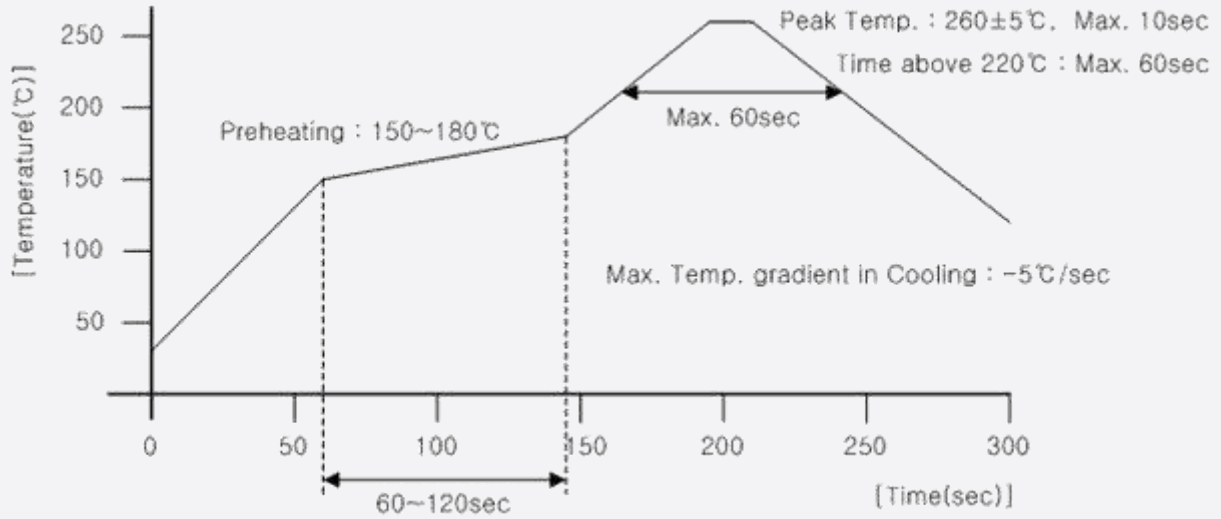

### b) Manual Soldering Conditions

Not more than 5 seconds @ max. 300 °C, under soldering iron.

## 7. Tape & Reel

### a) Taping Dimension

(unit: mm)

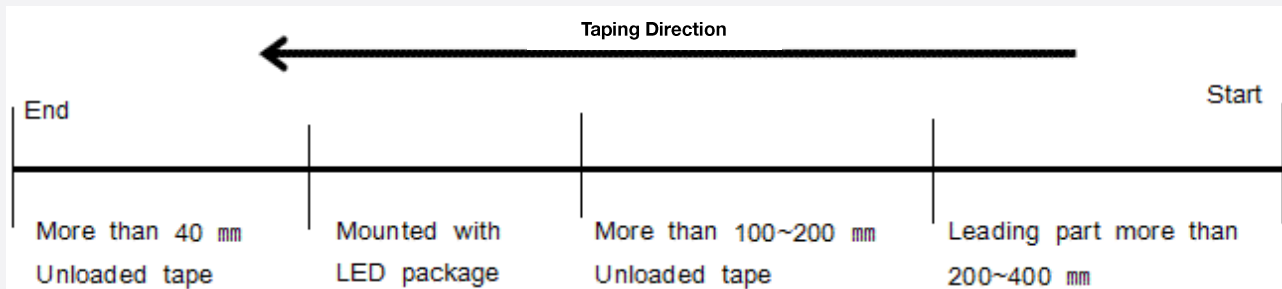
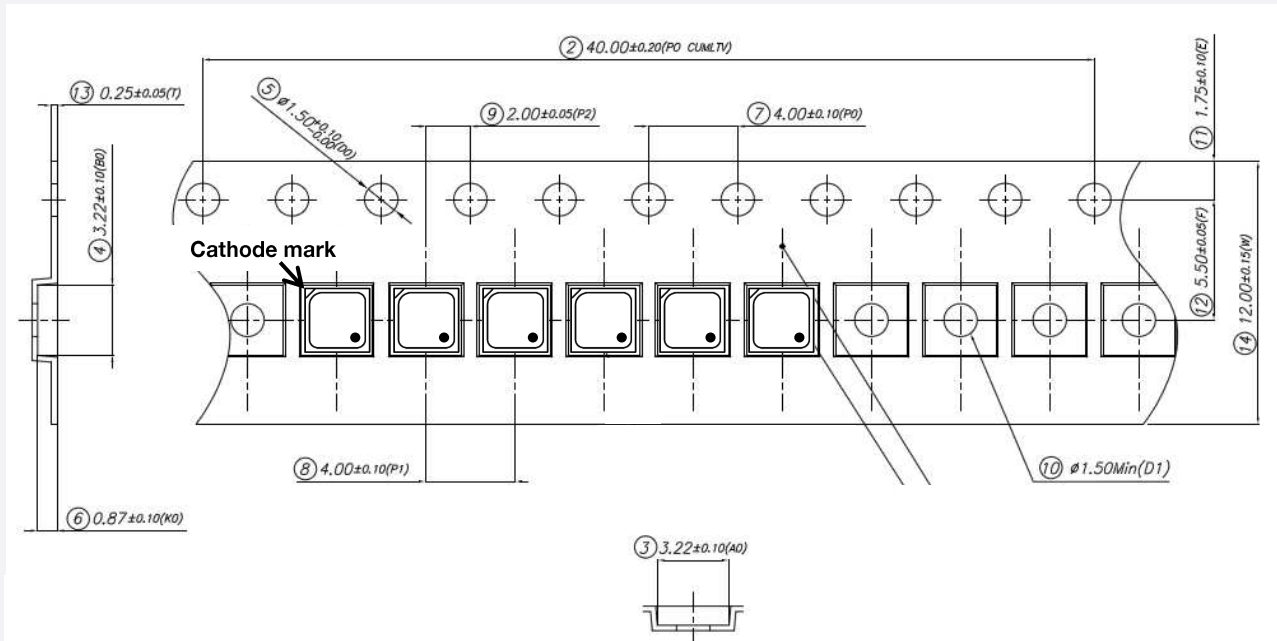

## b) Reel Dimension

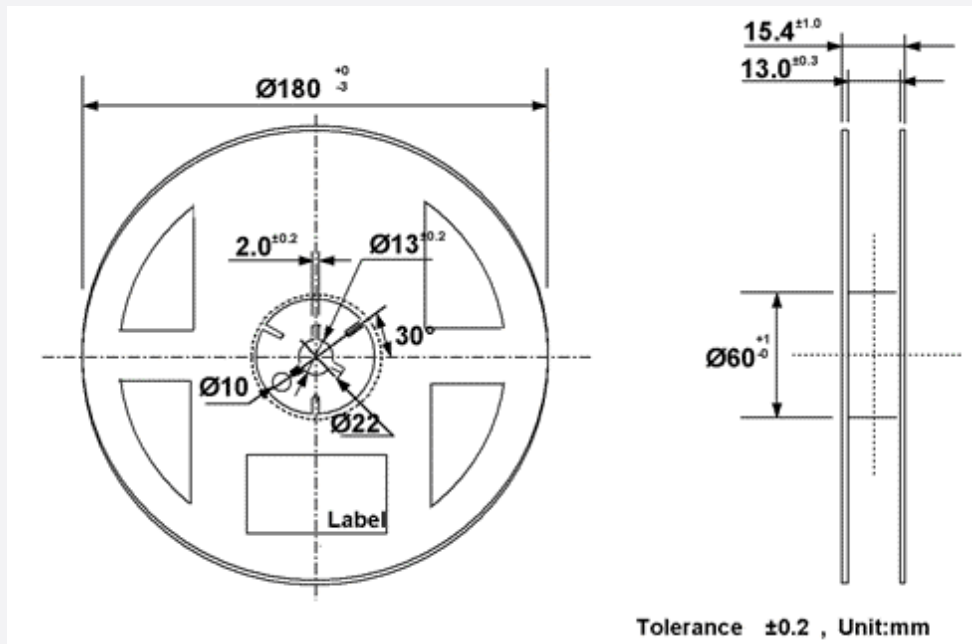
**Notes:**

- 1) Quantity: The quantity/reel is 4,000 pcs
- 2) Cumulative tolerance: Cumulative tolerance / 10 pitches is  $\pm 0.2$  mm
- 3) Adhesion strength of cover tape: Adhesion strength is 0.1-0.7 N when the cover tape is turned off from the carrier tape at  $10^\circ$  angle to the carrier tape
- 4) Packaging: P/N, Manufacturing data code no. and quantity are indicated on the aluminum packing bag



## 8. Label Structure

### a) Label Structure

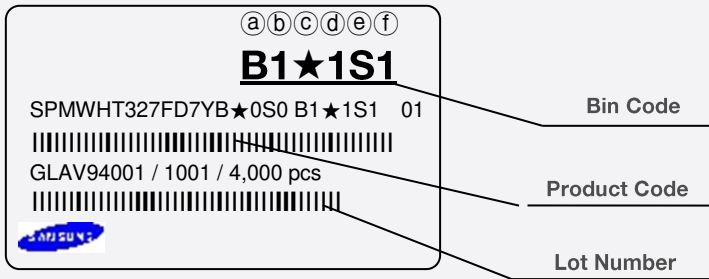

Note: Denoted bin code and product code above is only an example  
'★' means all kind of Chromaticity Coordinate Ranks

Bin Code:

- ⒶⒷ: Forward Voltage bin (refer to page 7)
- ⒸⒹ: Chromaticity bin (refer to page 9~12)
- ⒺⒻ: Luminous Flux bin (refer to page 4-5)

### b) Lot Number

The lot number is composed of the following characters:

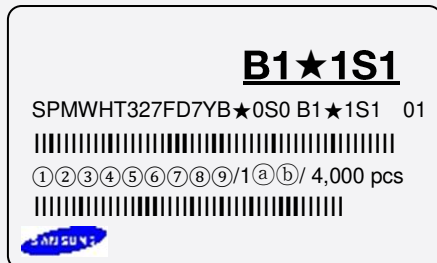

①②③④⑤⑥⑦⑧⑨ / 1ⒶⒷⒸ / 4,000 pcs

- ① : Production site (S: Giheung, Korea, G: Tianjin, China)
- ② : L (LED)
- ③ : Product state (A: Normal, B: Bulk, C: First Production, R: Reproduction, S: Sample)
- ④ : Year (Y: 2014, Z: 2015, A: 2016, ...)
- ⑤ : Month (1~9, A, B, C)
- ⑥ : Day (1~9, A, B~V)
- ⑦⑧⑨ : Product serial number (001 ~ 999)
- ⒶⒷⒸ : Reel number (001 ~ 999)

## 9. Packing Structure

### a-1) Packing Process

Reel

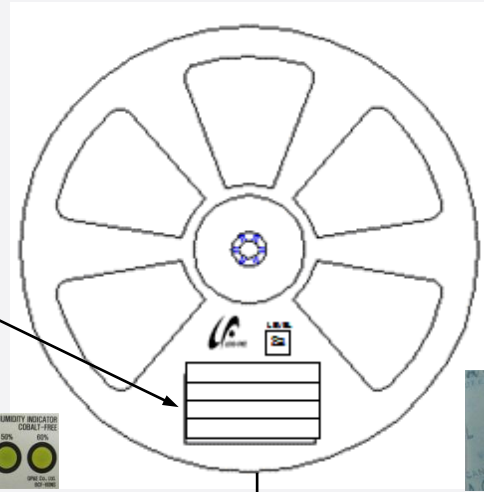
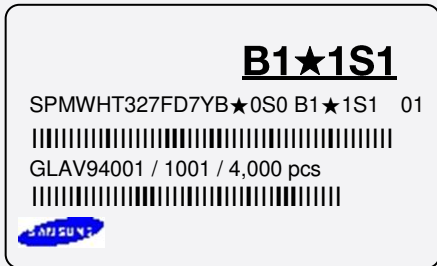

Aluminum Vinyl Packing Bag

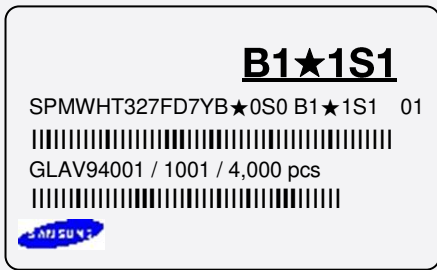

Outer Box

Material: Paper (SW3B(B))

Type	Size (mm)			Note
	L	W	H	
7 inch L	245 ± 5	220 ± 5	182 ± 5	Up to 10 reels
7 inch S	245 ± 5	220 ± 5	86 ± 5	Up to 5 reels

Side Label

