



Chipsmall Limited consists of a professional team with an average of over 10 year of expertise in the distribution of electronic components. Based in Hongkong, we have already established firm and mutual-benefit business relationships with customers from,Europe,America and south Asia,supplying obsolete and hard-to-find components to meet their specific needs.

With the principle of “Quality Parts,Customers Priority,Honest Operation,and Considerate Service”,our business mainly focus on the distribution of electronic components. Line cards we deal with include Microchip,ALPS,ROHM,Xilinx,Pulse,ON,Everlight and Freescale. Main products comprise IC,Modules,Potentiometer,IC Socket,Relay,Connector.Our parts cover such applications as commercial,industrial, and automotives areas.

We are looking forward to setting up business relationship with you and hope to provide you with the best service and solution. Let us make a better world for our industry!



Contact us

Tel: +86-755-8981 8866 Fax: +86-755-8427 6832

Email & Skype: info@chipsmall.com Web: www.chipsmall.com

Address: A1208, Overseas Decoration Building, #122 Zhenhua RD., Futian, Shenzhen, China



GENERAL DESCRIPTION

The SPX2940 is a 1A, accurate voltage regulators with a low drop out voltage of 280mV (typical) at 1A.

These regulators are specifically designed for low voltage applications that require a low dropout voltage and a fast transient response. They are fully fault protected against over-current, reverse battery, and positive and negative voltage transients.

The SPX2940 is offered in 3-pin TO-220 & TO-263 packages. For a 3A version, refer to the SPX29300 data sheet.

APPLICATIONS

- **Power Supplies**
- **LCD Monitors**
- **Portable Instrumentation**
- **Medical and Industrial Equipments**

FEATURES

- **Guaranteed 1.5A Peak Current**
- **Low Quiescent Current**
- **Low Dropout Voltage of 280mV at 1A**
- **Extremely Tight Load and Line Regulation**
- **Extremely Fast Transient Response**
- **Reverse-battery Protection**
- **Internal Thermal Protection**
- **Internal Short Circuit Current Limit**
- **Replacement for LM2940, MIC2940A, AS2940**
- **Standard TO-220 and TO-263 packages**

TYPICAL APPLICATION DIAGRAM

Fig. 1: SPX2940 Application Diagram – Fixed Output Linear Regulator



ABSOLUTE MAXIMUM RATINGS

These are stress ratings only and functional operation of the device at these ratings or any other above those indicated in the operation sections of the specifications below is not implied. Exposure to absolute maximum rating conditions for extended periods of time may affect reliability.

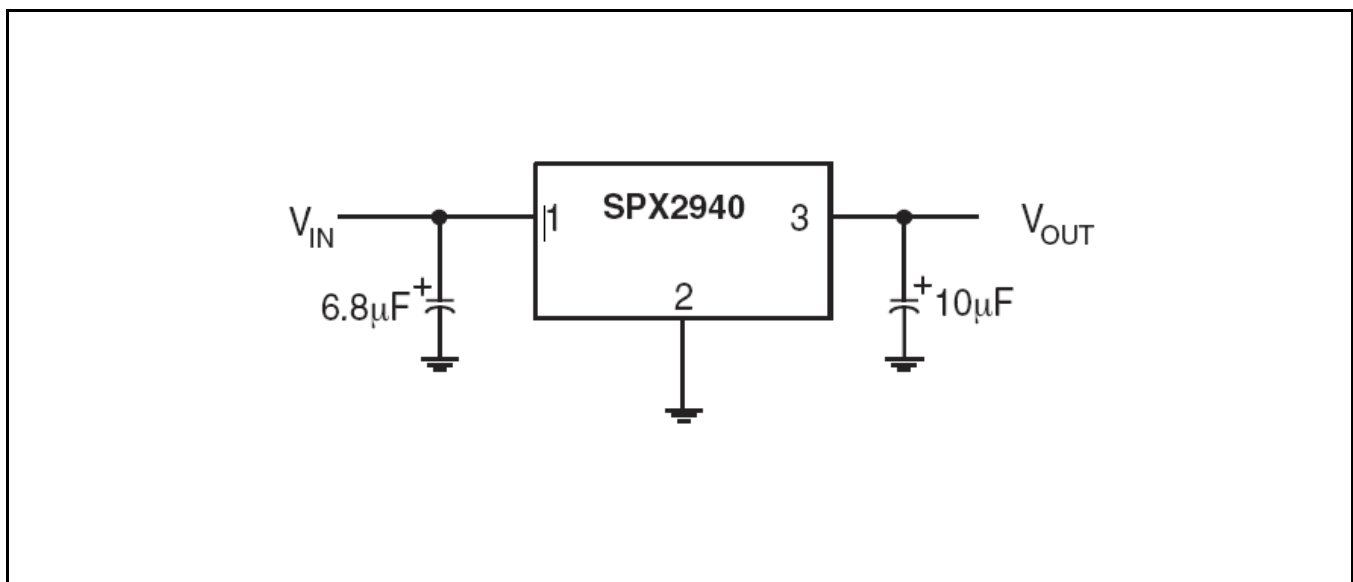
Input Voltage V_{IN} 16V¹
 Storage Temperature -65°C to 150°C
 Lead Temperature (Soldering, 5 sec) 260°C

OPERATING RATINGS

Junction Temperature Range -40°C to 125°C
 TO-220 Package
 Thermal Resistance, Junction to Case (at T_A) 4°C/W
 TO-263 Package
 Thermal Resistance, Junction to Case (at T_A) 4°C/W

Note 1: Maximum positive supply voltage of 20V must be of limited duration (<100ms) and duty cycle (<1%). The maximum continuous supply voltage is 16V.

ELECTRICAL SPECIFICATIONS

Specifications with standard type are for an Operating Ambient Temperature of $T_A = 25^\circ\text{C}$ only; limits applying over the full Operating Junction Temperature range are denoted by a “•”. Minimum and Maximum limits are guaranteed through test, design, or statistical correlation. Typical values represent the most likely parametric norm at $T_A = 25^\circ\text{C}$, and are provided for reference purposes only. Unless otherwise indicated, $V_{IN} = V_{OUT} + 1\text{V}$, $I_{OUT} = 10\text{mA}$, $C_{IN} = 6.8\mu\text{F}$, $C_{OUT} = 10\mu\text{F}$, $T_A = 25^\circ\text{C}$.

Parameter	Min.	Typ.	Max.	Units	Conditions
5.0V version					
Output Voltage	4.850	5.0	5.150	V	$I_{OUT} = 10\text{mA}$
	4.750	5.0	5.250	V	$10\text{mA} \leq I_{OUT} \leq 1\text{A}$, $6\text{V} \leq V_{IN} \leq 16\text{V}$
Line Regulation		0.2	1.0	%	$I_{OUT} = 10\text{mA}$, $(V_{OUT} + 1\text{V}) \leq V_{IN} \leq 16\text{V}$
Load Regulation		0.3	1.5	%	$V_{IN} = V_{OUT} + 1\text{V}$, $10\text{mA} \leq I_{OUT} \leq 1\text{A}$
$\frac{\Delta V}{\Delta T}$ - Output Voltage temperature Coefficient		20	100	ppm/°C	•
Dropout Voltage ² (except 1.8V version)		70	200	mV	• $I_{OUT} = 100\text{mA}$
		280	550	mV	• $I_{OUT} = 1\text{A}$
Ground Current ³		12	25	mA	• $I_{OUT} = 750\text{mA}$, $V_{IN} = V_{OUT} + 1\text{V}$
		18		mA	$I_{OUT} = 1\text{A}$
I_{GNDDO} Ground Pin Current at Dropout		1.2		mA	$V_{IN} = 0.1\text{V}$ less than specified V_{OUT} $I_{OUT} = 10\text{mA}$,
Current Limit		1.5	2.2	A	$V_{OUT} = 0\text{V}$ ⁴
Output Noise Voltage		400		μV_{RMS}	10Hz-100KHz, $I_L = 100\text{mA}$, $C_L = 10\mu\text{F}$
		260		μV_{RMS}	10Hz-100KHz, $I_L = 100\text{mA}$, $C_L = 33\mu\text{F}$

Note 2: Dropout voltage is defined as the input to output differential when the output voltage drops to 99% of its normal value.

Note 3: Ground pin current is the regulator quiescent current. The total current drawn from the source is the sum of the load current to the ground current.

Note 4: $V_{IN} = V_{OUT(\text{NOMINAL})} + 1\text{V}$. For example, use $V_{IN} = 4.3\text{V}$ for a 3.3V regulator. Employ pulse-testing procedures to minimize temperature rise.

BLOCK DIAGRAM

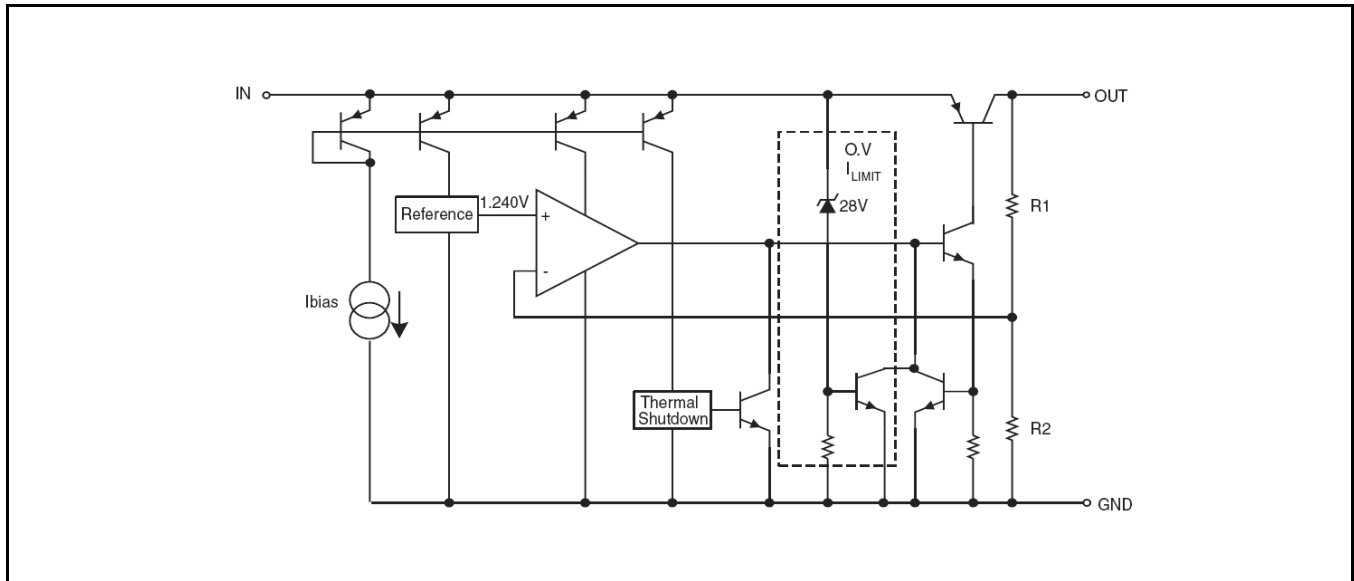

Fig. 2: SPX2940 Block Diagram

PIN ASSIGNMENT

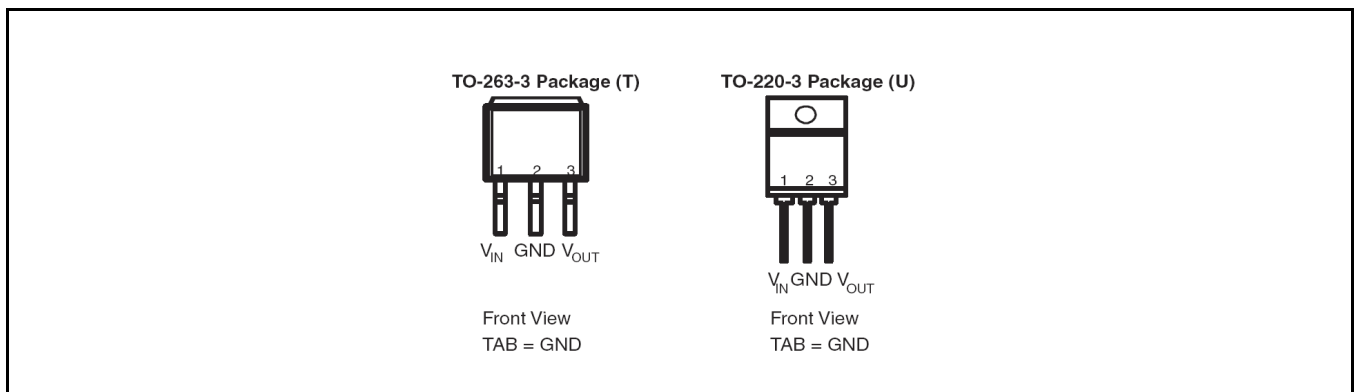

Fig. 3: SPX2940 Pin Assignment

ORDERING INFORMATION

Part Number	Temperature Range	Marking	Package	Packing Quantity	Note 1	Note 2
SPX2940T-L-5-0/TR	-40°C ≤ T _J ≤ +125°C	SPX2940T 50YYWWLX	3-pin TO-263	500/Tape & Reel	Lead Free	5.0V Output Voltage
SPX2940U-L-5-0	-40°C ≤ T _J ≤ +125°C	SPX2940U 50YYWWLX	3-pin TO-220	Bulk	Lead Free	5.0V Output Voltage

"YY" = Year – "WW" = Work Week – "X" = Lot Number

TYPICAL PERFORMANCE CHARACTERISTICS

Schematic and BOM from Application Information section of this datasheet.

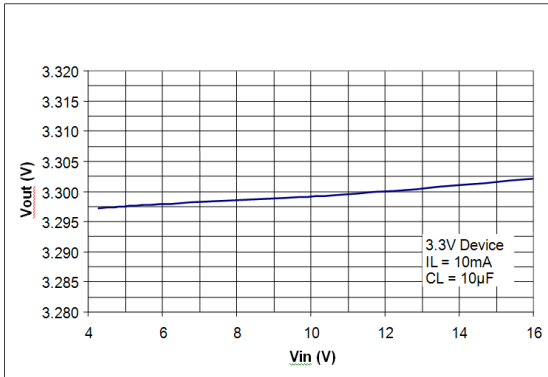

Fig. 4: Line Regulation

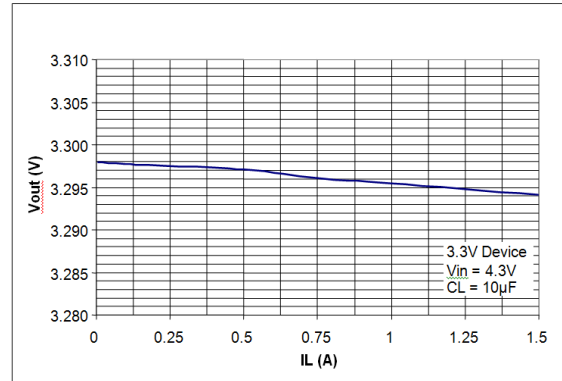

Fig. 5: Load Regulation

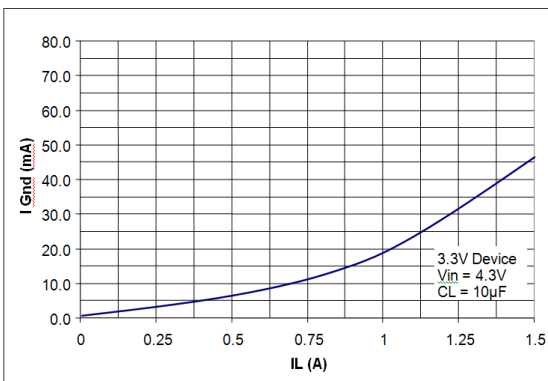

Fig. 6: Ground Current vs Load Current

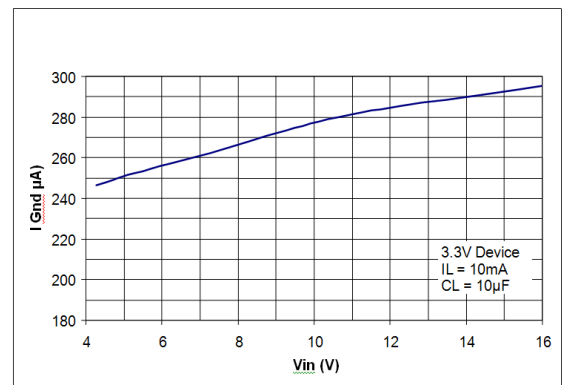

Fig. 7: Ground Current vs Input Voltage

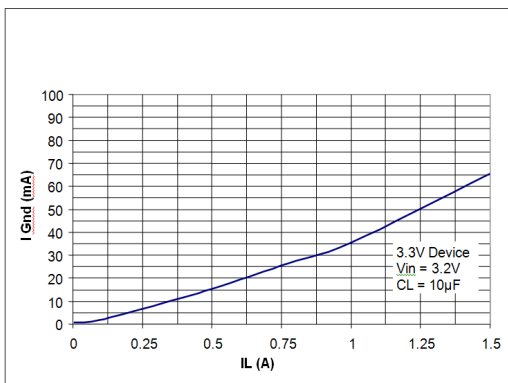

Fig. 8: Ground Current vs Current in Dropout

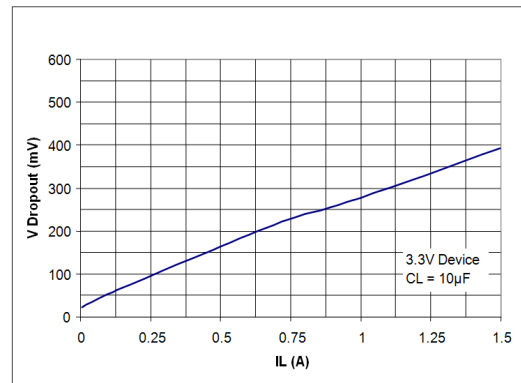

Fig. 9: Dropout Voltage vs Load Current

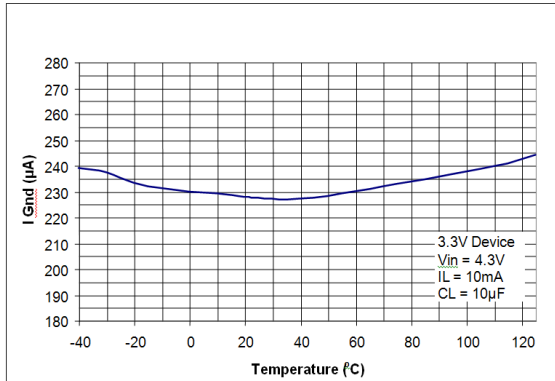

Fig. 10: Ground Current vs Temperature
 $I_{LOAD} = 100\text{mA}$

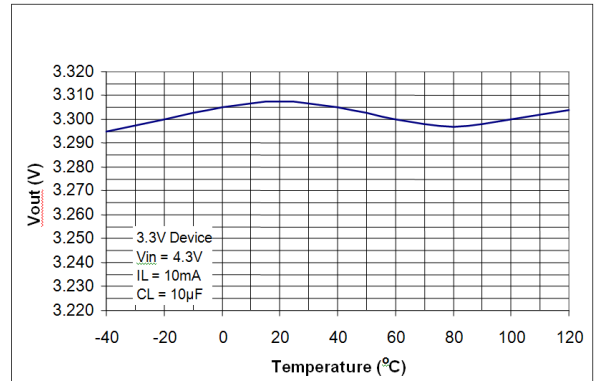

Fig. 11: Output Voltage vs Temperature
 $I_{LOAD} = 100\text{mA}$

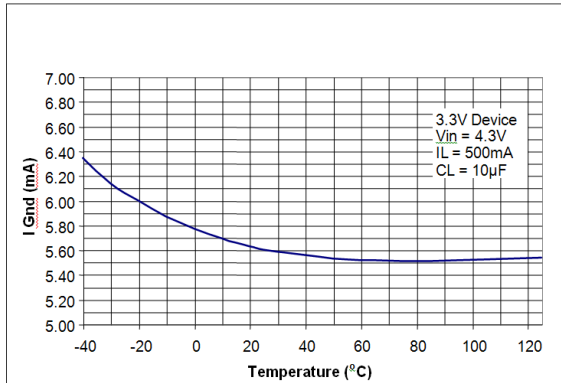

Fig. 12: Ground Current vs Temperature
 $I_{LOAD} = 500\text{mA}$

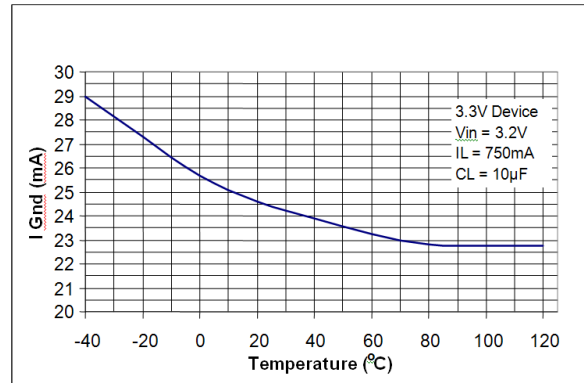

Fig. 13: Ground Current vs Temperature
Dropout, $I_{LOAD} = 750\text{mA}$

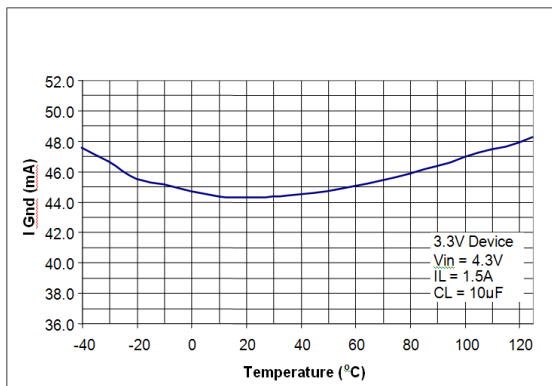

Fig. 14: Ground Current vs Temperature
 $I_{LOAD} = 1.5\text{A}$

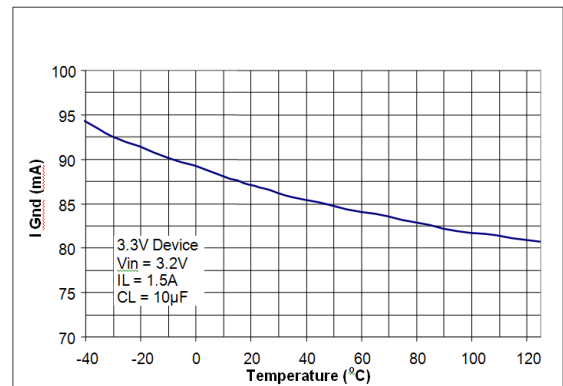

Fig. 15: Ground Current vs Temperature
Dropout, $I_{LOAD} = 1.5\text{A}$

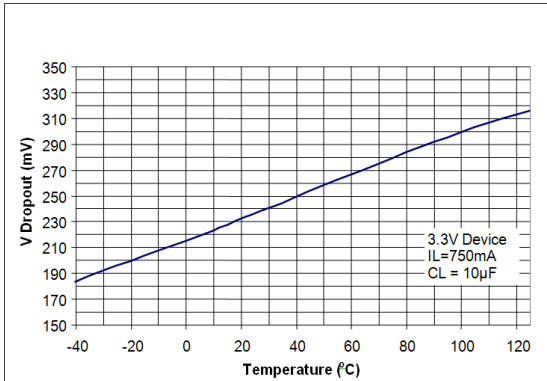

Fig. 16: Dropout Voltage vs Temperature
 $I_{\text{LOAD}} = 750\text{mA}$

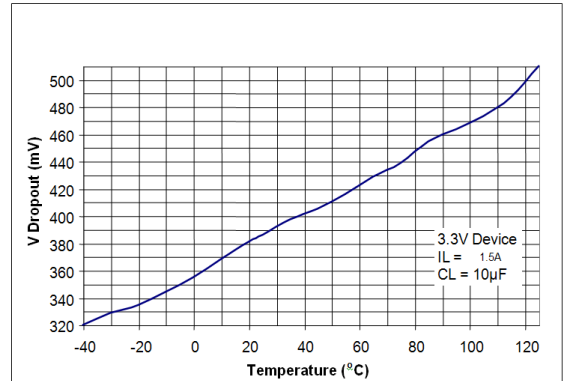

Fig. 17: Dropout Voltage vs Temperature
 $I_{\text{LOAD}} = 1.5\text{A}$

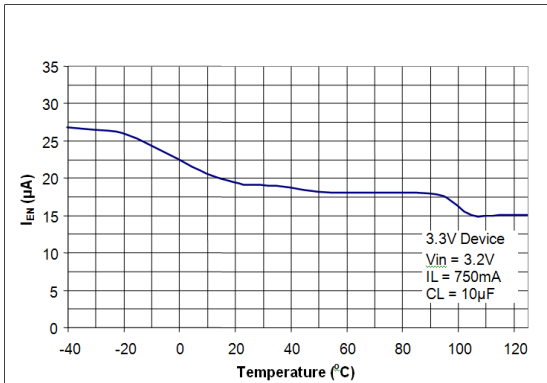

Fig. 18: Enable Current vs Temperature
 $V_{\text{EN}} = 16\text{V}$

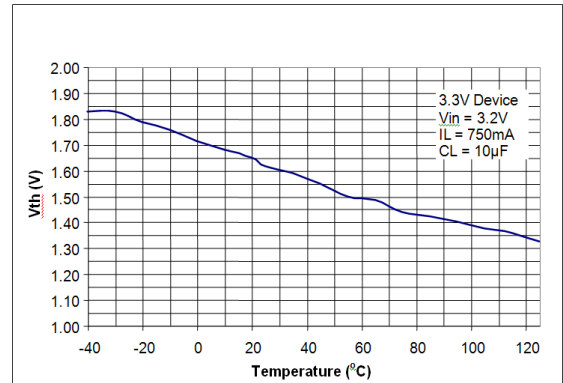

Fig. 19: Enable Threshold vs Temperature

THEORY OF OPERATION

The SPX2940 incorporates protection against over-current faults, reversed load insertion, over temperature operation, and positive and negative transient voltage.

THERMAL CONSIDERATIONS

Although the SPX2940 offers limiting circuitry for overload conditions, it is still necessary to insure that the maximum junction temperature is not exceeded in the application. Heat will flow through the lowest resistance path, the junction-to-case path. In order to insure the best thermal flow of the component, proper mounting is required. Since the case of the device is electrically connected to the output, the case must be electrically isolated using a thermally conductive spacer, which itself contributes some small additional thermal resistance. Consult heatsink manufacturer for thermal resistance and design of heatsink.

TO-220 Design Example:

Assume that $V_{IN} = 10V$, $V_{OUT} = 5V$, $I_{OUT} = 1.5A$, $T_A = 50^{\circ}C/W$, $\theta_{HA} = 1^{\circ}C/W$, $\theta_{CH} = 2^{\circ}C/W$, and $\theta_{JC} = 3^{\circ}C/W$.

Where T_A = ambient temperature

θ_{HA} = heatsink to ambient thermal resistance

θ_{CH} = case to heatsink thermal resistance

θ_{JC} = junction to case thermal resistance

The power calculated under these conditions is:

$$P_D = (V_{IN} - V_{OUT}) * I_{OUT} = 7.5W.$$

And the junction temperature is calculated as

$$T_J = T_A + P_D * (\theta_{HA} + \theta_{CH} + \theta_{JC}) \text{ or}$$

$$T_J = 50 + 7.5 * (1 + 2 + 3) = 95^{\circ}C$$

Reliable operation is insured.

CAPACITOR REQUIREMENTS

The output capacitor is needed to insure stability and minimize the output noise. The value of the capacitor varies with the load. However, a minimum value of 10 μ F aluminum capacitor will guarantee stability over all load conditions. A tantalum capacitor is

recommended if a faster load transient response is needed.

If the power source has a high AC impedance, a 0.1 μ F ceramic capacitor between input & ground is recommended.

MINIMUM LOAD CURRENT

To ensure a proper behavior of the regulator under light load, a minimum load of 5mA for SPX2940 is required.

consequat eu, consequat eu, ullamcorper pretium, magna. Aenean varius turpis sed metus. Donec erat. Nunc urna pede, accumsan sed, tristique non, lobortis sit amet, pede.

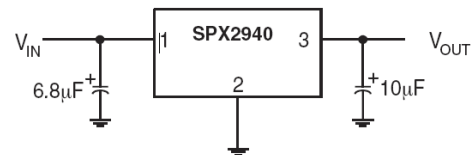

Fig. 20: Fixed Output Linear Regulator

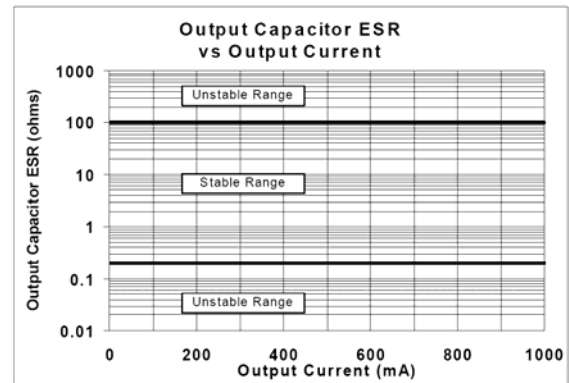

Fig. 21: Ouput Cap ESR vs I_{OUT}

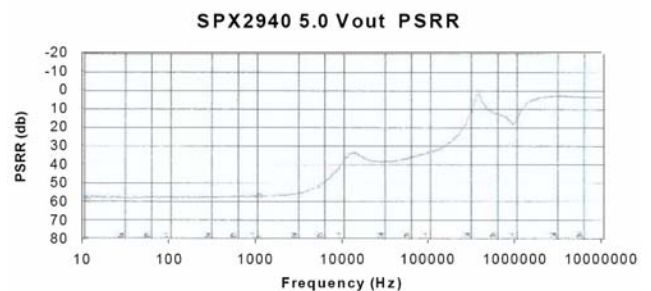
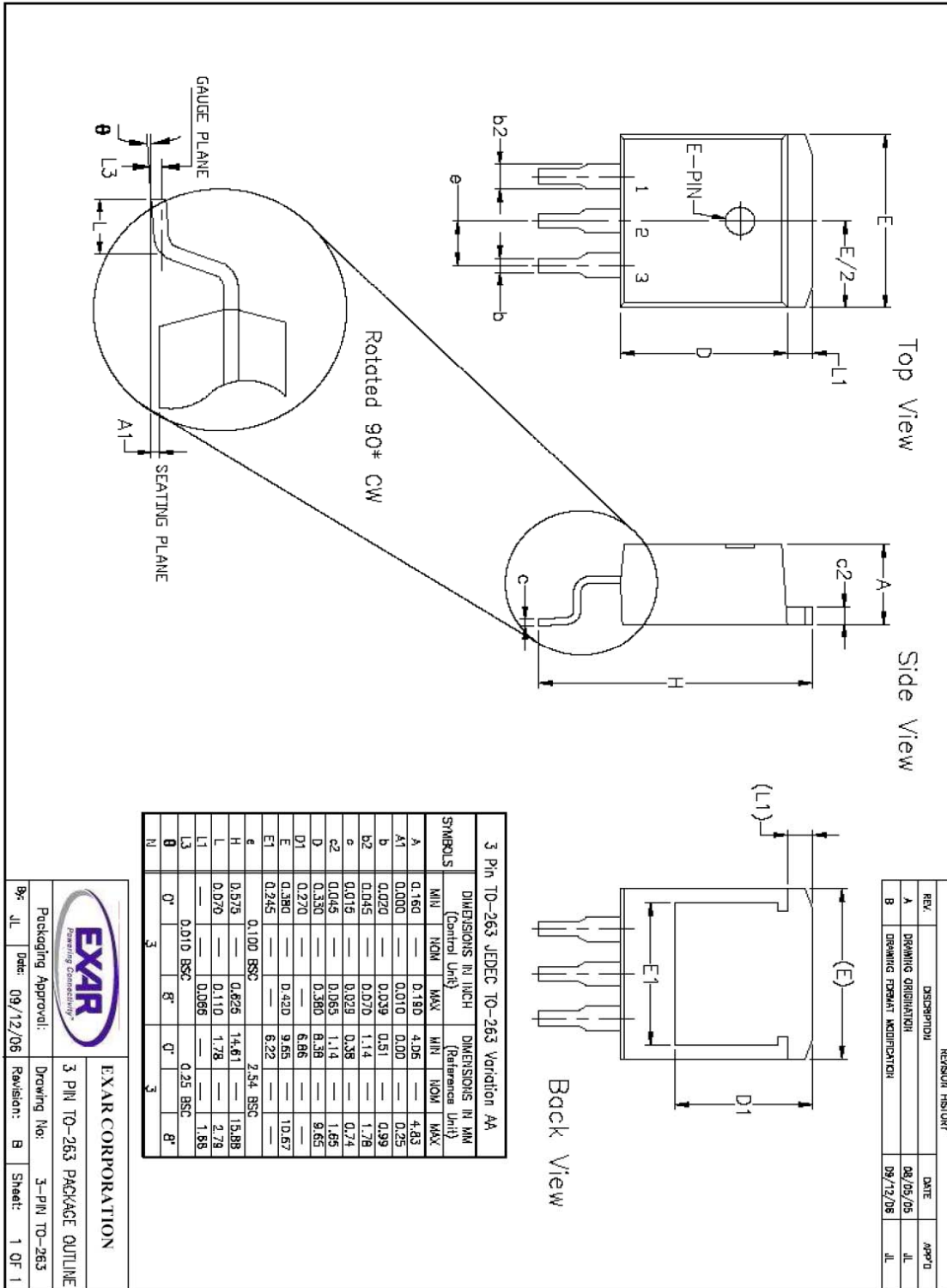

Fig. 22: 5.0V_{OUT} PSRR $V_{IN} = 10V$, $V_{OUT} = 5V$
 $C_{OUT} = 22F$, $I_{OUT} = 10mA$

PACKAGE SPECIFICATION

3-PIN TO-263



3-PIN TO-220

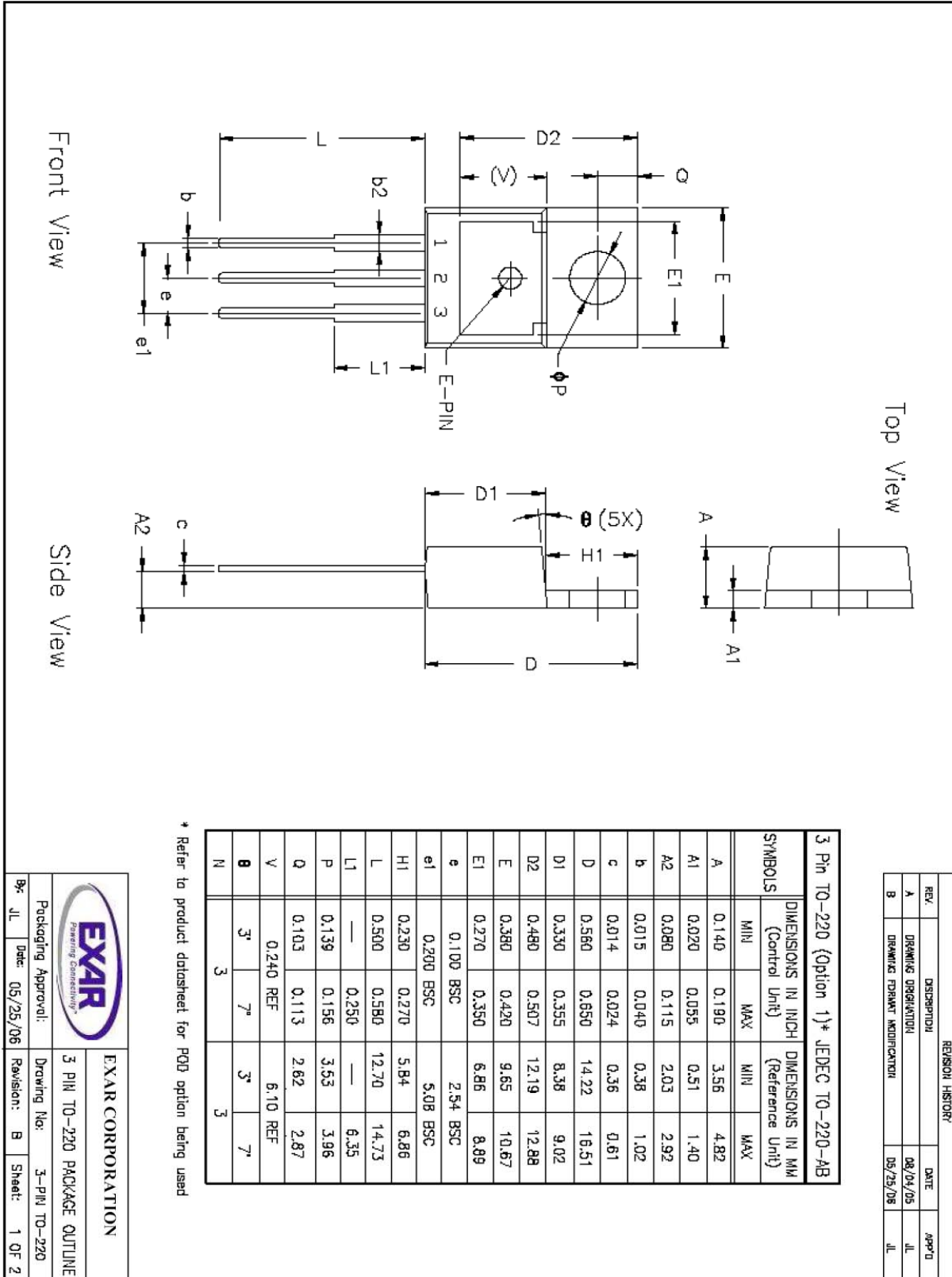



REVISION HISTORY

Revision	Date	Description
F	11/03/2007	
2.0.0	08/06/2009	Reformat of Datasheet Updated θ_{JC} values

FOR FURTHER ASSISTANCE

Email: customersupport@exar.com
Exar Technical Documentation: <http://www.exar.com/TechDoc/default.aspx?>

EXAR CORPORATION

HEADQUARTERS AND SALES OFFICES

48720 Kato Road
Fremont, CA 94538 – USA
Tel.: +1 (510) 668-7000
Fax: +1 (510) 668-7030
www.exar.com



NOTICE

EXAR Corporation reserves the right to make changes to the products contained in this publication in order to improve design, performance or reliability. EXAR Corporation assumes no responsibility for the use of any circuits described herein, conveys no license under any patent or other right, and makes no representation that the circuits are free of patent infringement. Charts and schedules contained here in are only for illustration purposes and may vary depending upon a user's specific application. While the information in this publication has been carefully checked; no responsibility, however, is assumed for inaccuracies.

EXAR Corporation does not recommend the use of any of its products in life support applications where the failure or malfunction of the product can reasonably be expected to cause failure of the life support system or to significantly affect its safety or effectiveness. Products are not authorized for use in such applications unless EXAR Corporation receives, in writing, assurances to its satisfaction that: (a) the risk of injury or damage has been minimized; (b) the user assumes all such risks; (c) potential liability of EXAR Corporation is adequately protected under the circumstances.

Reproduction, in part or whole, without the prior written consent of EXAR Corporation is prohibited.