



Chipsmall Limited consists of a professional team with an average of over 10 year of expertise in the distribution of electronic components. Based in Hongkong, we have already established firm and mutual-benefit business relationships with customers from,Europe,America and south Asia,supplying obsolete and hard-to-find components to meet their specific needs.

With the principle of “Quality Parts,Customers Priority,Honest Operation,and Considerate Service”,our business mainly focus on the distribution of electronic components. Line cards we deal with include Microchip,ALPS,ROHM,Xilinx,Pulse,ON,Everlight and Freescale. Main products comprise IC,Modules,Potentiometer,IC Socket,Relay,Connector.Our parts cover such applications as commercial,industrial, and automotives areas.

We are looking forward to setting up business relationship with you and hope to provide you with the best service and solution. Let us make a better world for our industry!



## Contact us

Tel: +86-755-8981 8866 Fax: +86-755-8427 6832

Email & Skype: info@chipsmall.com Web: www.chipsmall.com

Address: A1208, Overseas Decoration Building, #122 Zhenhua RD., Futian, Shenzhen, China



## Automotive Dual N-Channel 60 V (D-S) 175 °C MOSFET

PRODUCT SUMMARY	
$V_{DS}$ (V)	60
$R_{DS(on)}$ ( $\Omega$ ) at $V_{GS} = 10$ V	0.080
$I_D$ (A)	$\pm 3.7$
Configuration	Dual

**FEATURES**

- TrenchFET® Power MOSFET
- Package with Low Thermal Resistance

**AEC-Q101 RELIABILITY**

- Passed all AEC-Q101 Reliability Testing
- Characterization Ongoing

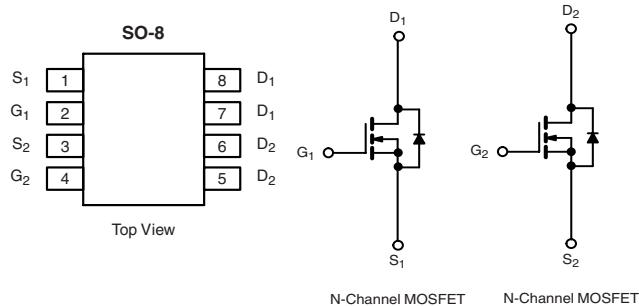
 Available  
**RoHS\***  
 COMPLIANT

ORDERING INFORMATION	
Package	SO-8
Lead (Pb)-free	SQ9945AEY-T1-E3
SnPb	SQ9945AEY-T1

ABSOLUTE MAXIMUM RATINGS $T_C = 25$ °C, unless otherwise noted			
PARAMETER	SYMBOL	LIMIT	UNIT
Drain-Source Voltage	$V_{DS}$	60	V
Gate-Source Voltage	$V_{GS}$	$\pm 20$	
Continuous Drain Current <sup>a</sup>	$I_D$	$T_C = 25$ °C	- 3.7
		$T_C = 70$ °C	- 3.2
Continuous Source Current (Diode Conduction) <sup>a</sup>	$I_S$	2	A
Pulsed Drain Current <sup>b</sup>	$I_{DM}$	25	
Single Pulse Avalanche Energy	$E_{AS}$	-	mJ
Single Pulse Avalanche Current			
Maximum Power Dissipation <sup>b</sup>	$P_D$	$T_C = 25$ °C	2.4
		$T_A = 70$ °C	1.7
Operating Junction and Storage Temperature Range	$T_J, T_{stg}$	- 55 to + 175	°C

THERMAL RESISTANCE RATINGS			
PARAMETER	SYMBOL	LIMIT	UNIT
Junction-to-Ambient	$R_{thJA}$	-	°C/W
Junction-to-Case (Drain)			

**Notes**

- Package limited.
- Pulse test; pulse width  $\leq 300$   $\mu$ s, duty cycle  $\leq 2$  %.
- When mounted on 1" square PCB (FR-4 material).

\* Pb containing terminations are not RoHS compliant, exemptions may apply



<b>SPECIFICATIONS</b> $T_C = 25\text{ }^\circ\text{C}$ , unless otherwise noted						
PARAMETER	SYMBOL	TEST CONDITIONS	MIN.	TYP.	MAX.	UNIT
<b>Static</b>						
Drain-Source Breakdown Voltage	$V_{DS}$	$V_{GS} = 0\text{ V}, I_D = 250\text{ }\mu\text{A}$	-	-	-	V
Gate-Source Threshold Voltage	$V_{GS(th)}$	$V_{DS} = V_{GS}, I_D = 250\text{ }\mu\text{A}$	1.0	-	3.0	
Gate-Source Leakage	$I_{GSS}$	$V_{DS} = 0\text{ V}, V_{GS} = \pm 20\text{ V}$	-	-	$\pm 100$	nA
Zero Gate Voltage Drain Current	$I_{DSS}$	$V_{GS} = 0\text{ V}$ $V_{DS} = 60\text{ V}$	-	-	1.0	$\mu\text{A}$
		$V_{GS} = 0\text{ V}$ $V_{DS} = 60\text{ V}$	-	-	10	
		$V_{GS} = 0\text{ V}$ $V_{DS} = 60\text{ V}, T_J = 55\text{ }^\circ\text{C}$	-	-	-	
On-State Drain Current <sup>a</sup>	$I_{D(on)}$	$V_{GS} = 10\text{ V}$ $V_{DS} \geq 5\text{ V}$	20	-	-	A
Drain-Source On-State Resistance <sup>a</sup>	$R_{DS(on)}$	$V_{GS} = 10\text{ V}$ $I_D = 3.7\text{ A}$	-	0.060	0.080	$\Omega$
		$V_{GS} = 10\text{ V}$ $I_D = 30\text{ A}, T_J = 125\text{ }^\circ\text{C}$	-	-	-	
		$V_{GS} = 10\text{ V}$ $I_D = 30\text{ A}, T_J = 175\text{ }^\circ\text{C}$	-	-	-	
Forward Transconductance <sup>a</sup>	$g_{fs}$	$V_{DS} = 15\text{ V}, I_D = 3.7\text{ A}$	-	-	11	S
<b>Dynamic<sup>b</sup></b>						
Input Capacitance	$C_{iss}$	$V_{GS} = 0\text{ V}$ $V_{DS} = 25\text{ V}, f = 1\text{ MHz}$	-	-	-	pF
Output Capacitance	$C_{oss}$		-	-	-	
Reverse Transfer Capacitance	$C_{rss}$		-	-	-	
Total Gate Charge <sup>c</sup>	$Q_g$	$V_{GS} = 10\text{ V}$ $V_{DS} = 30\text{ V}, I_D = 3.7\text{ A}$	-	11	20	nC
Gate-Source Charge <sup>c</sup>	$Q_{gs}$		-	2	-	
Gate-Drain Charge <sup>c</sup>	$Q_{gd}$		-	2	-	
Turn-On Delay Time <sup>c</sup>	$t_{d(on)}$	$V_{DD} = 30\text{ V}, R_L = 30\text{ }\Omega$ $I_D \cong 1\text{ A}, V_{GEN} = 10\text{ V}, R_g = 6\text{ }\Omega$	-	9	20	ns
Rise Time <sup>c</sup>	$t_r$		-	10	20	
Turn-Off Delay Time <sup>c</sup>	$t_{d(off)}$		-	21	40	
Fall Time <sup>c</sup>	$t_f$		-	8	20	
<b>Source-Drain Diode Ratings and Characteristics</b> $T_C = 25\text{ }^\circ\text{C}$ <sup>b</sup>						
Pulsed Current <sup>a</sup>	$I_{SM}$		-	-	-	A
Forward Voltage	$V_{SD}$	$I_F = 85\text{ A}, V_{GS} = 0\text{ V}$	-	-	-	V
Reverse Recovery Time	$t_{rr}$	$I_F = 2\text{ A}, di/dt = 100\text{ A}/\mu\text{s}$	-	45	80	ns
Peak Reverse Recovery Current	$I_{RM(REC)}$		-	-	-	A
Reverse Recovery Charge	$Q_{rr}$		-	-	-	$\mu\text{C}$

**Notes**

- a. Pulse test; pulse width  $\leq 300\text{ }\mu\text{s}$ , duty cycle  $\leq 2\%$ .
- b. Guaranteed by design, not subject to production testing.
- c. Independent of operating temperature.

Stresses beyond those listed under "Absolute Maximum Ratings" may cause permanent damage to the device. These are stress ratings only, and functional operation of the device at these or any other conditions beyond those indicated in the operational sections of the specifications is not implied. Exposure to absolute maximum rating conditions for extended periods may affect device reliability.

**TYPICAL CHARACTERISTICS**  $T_A = 25\text{ }^\circ\text{C}$ , unless otherwise noted

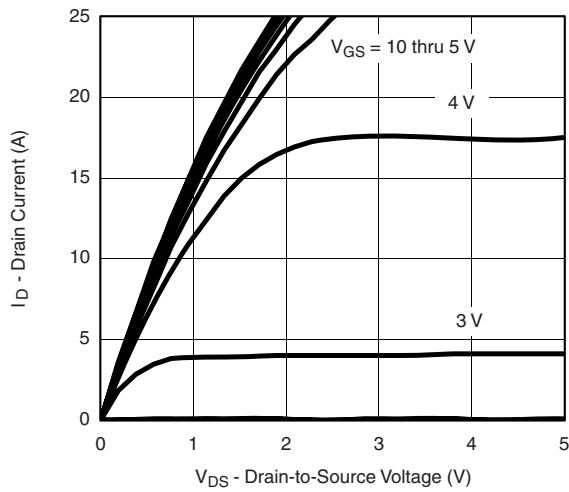

**Output Characteristics**

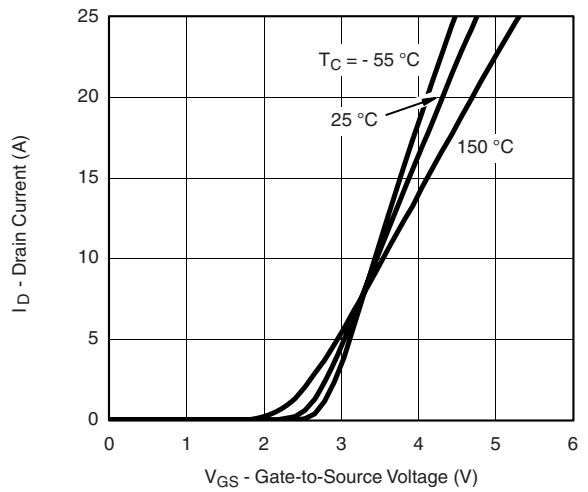

**Transfer Characteristics**

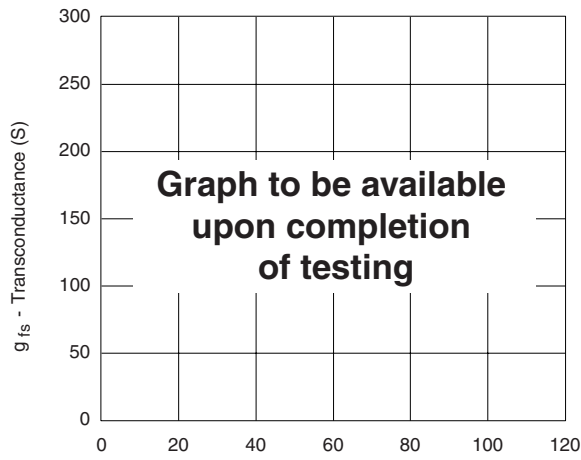

**Transconductance**

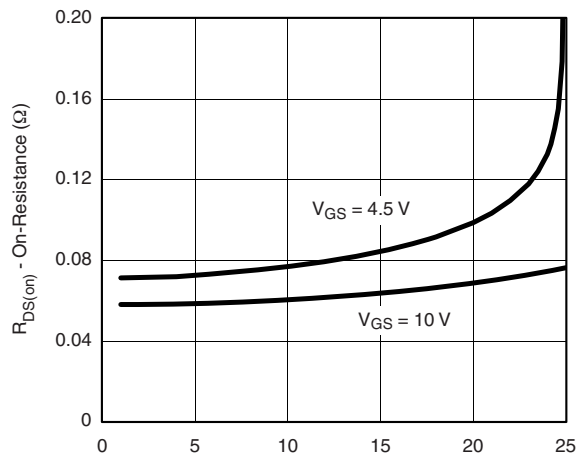

**On-Resistance vs. Drain Current**

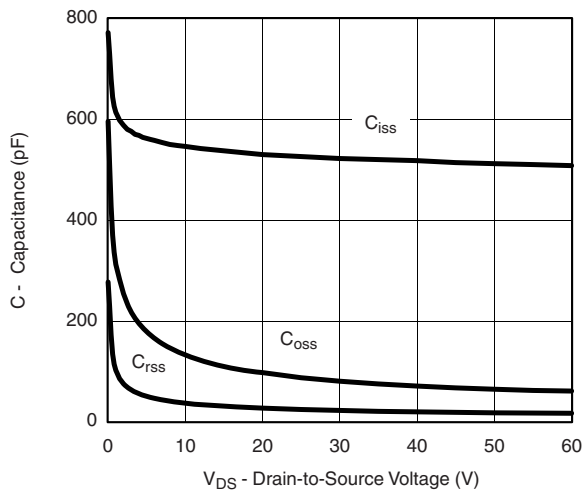

**Capacitance**

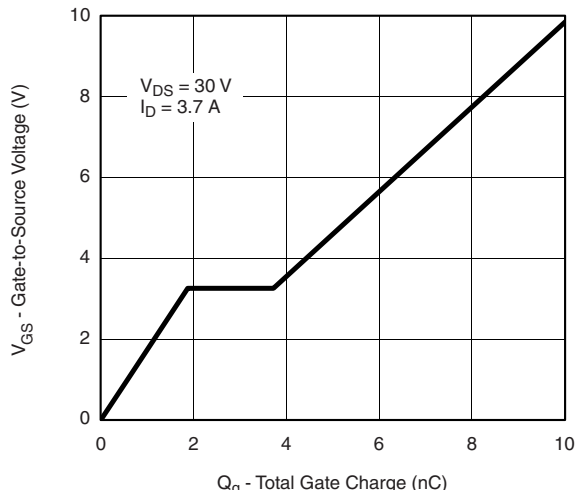

**Gate Charge**

**TYPICAL CHARACTERISTICS**  $T_A = 25\text{ }^\circ\text{C}$ , unless otherwise noted

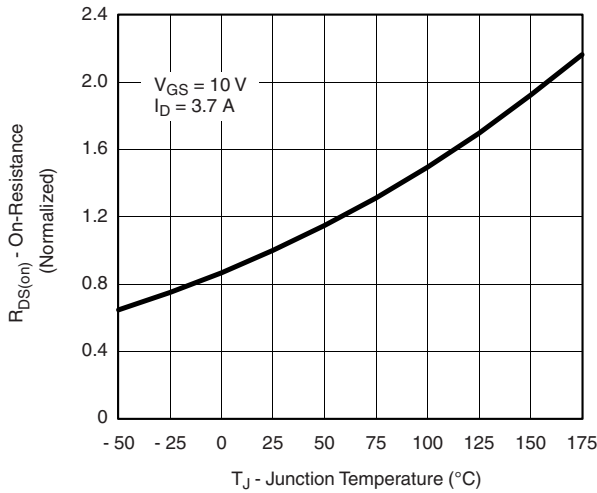

**On-Resistance vs. Junction Temperature**

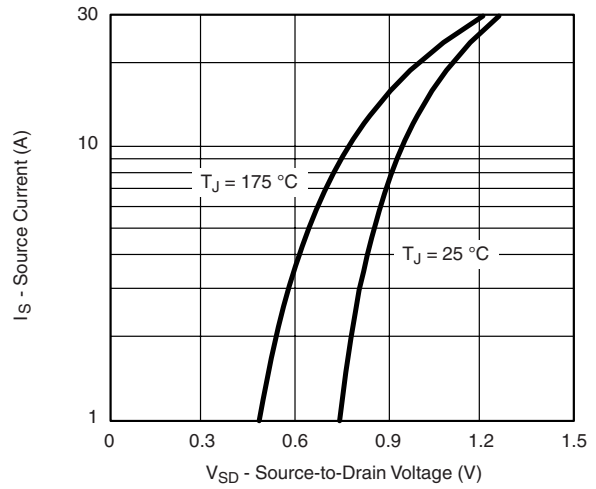

**Source Drain Diode Forward Voltage**

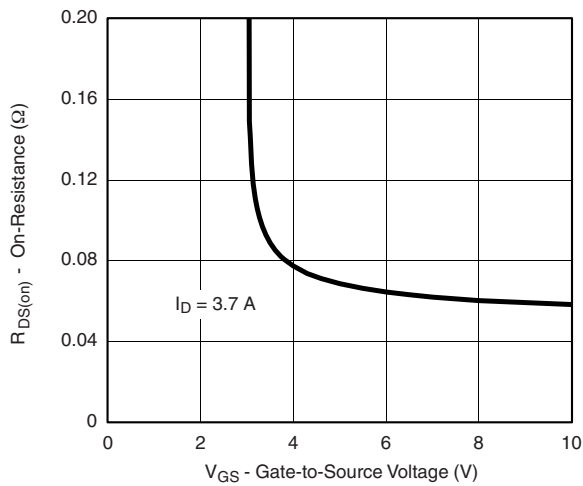

**On-Resistance vs. Gate-to-Source Voltage**

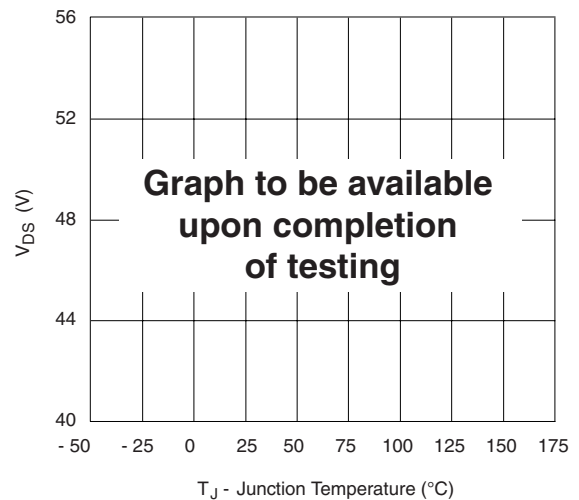

**Drain Source Breakdown vs. Junction Temperature**

**THERMAL RATINGS**  $T_A = 25\text{ }^\circ\text{C}$ , unless otherwise noted

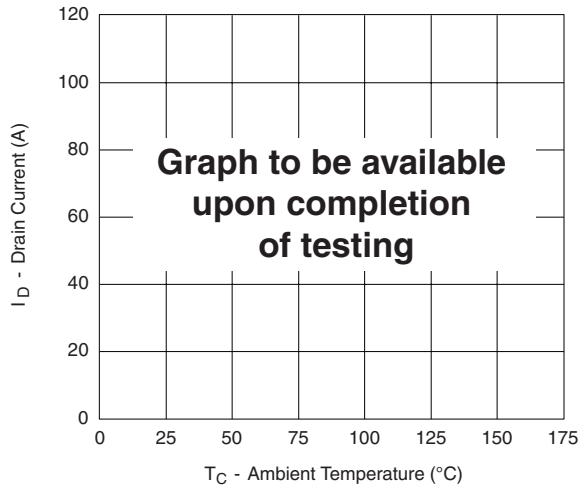

**Maximum Drain Current vs. Ambient Temperature**

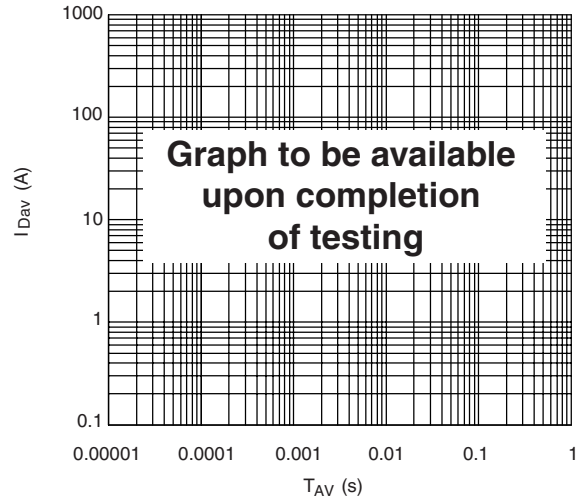

**Avalanche Current vs. Time**

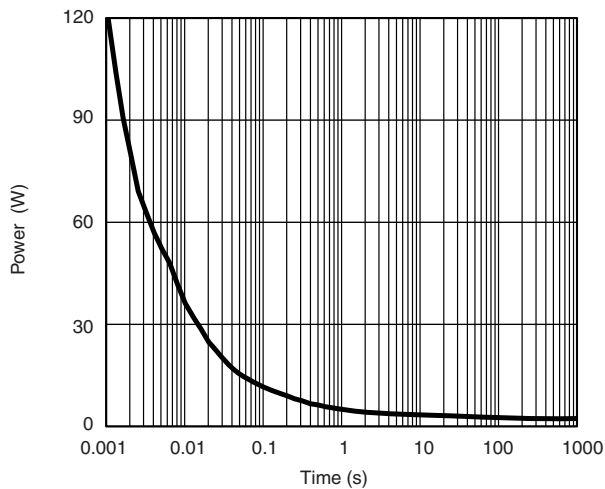

**Single Pulse Power, Junction-to-Ambient**

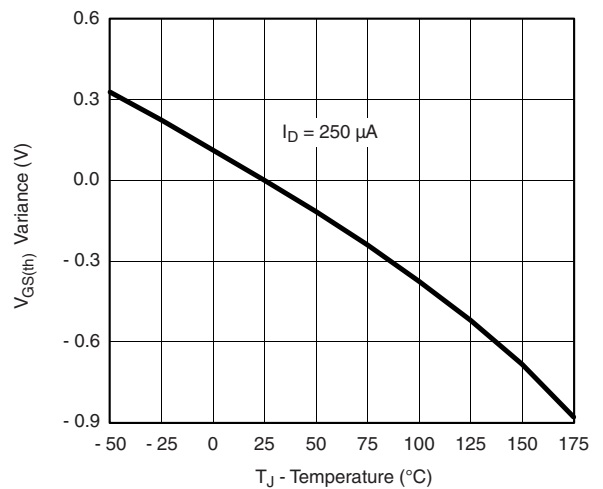

**Threshold Voltage**

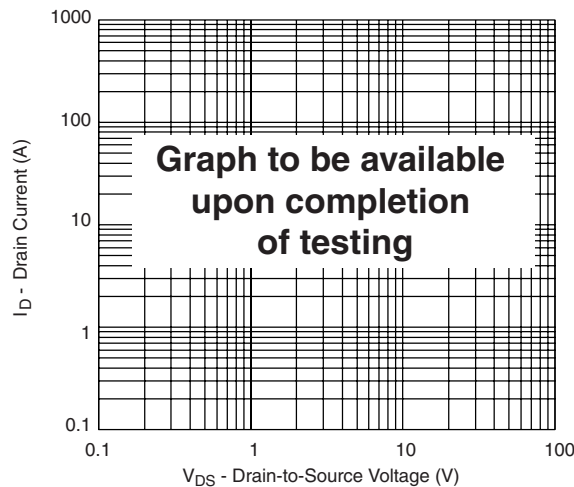

\*  $V_{GS} >$  minimum  $V_{GS}$  at which  $R_{DS(on)}$  is specified

**Safe Operating Area**

**THERMAL RATINGS**  $T_A = 25\text{ }^\circ\text{C}$ , unless otherwise noted

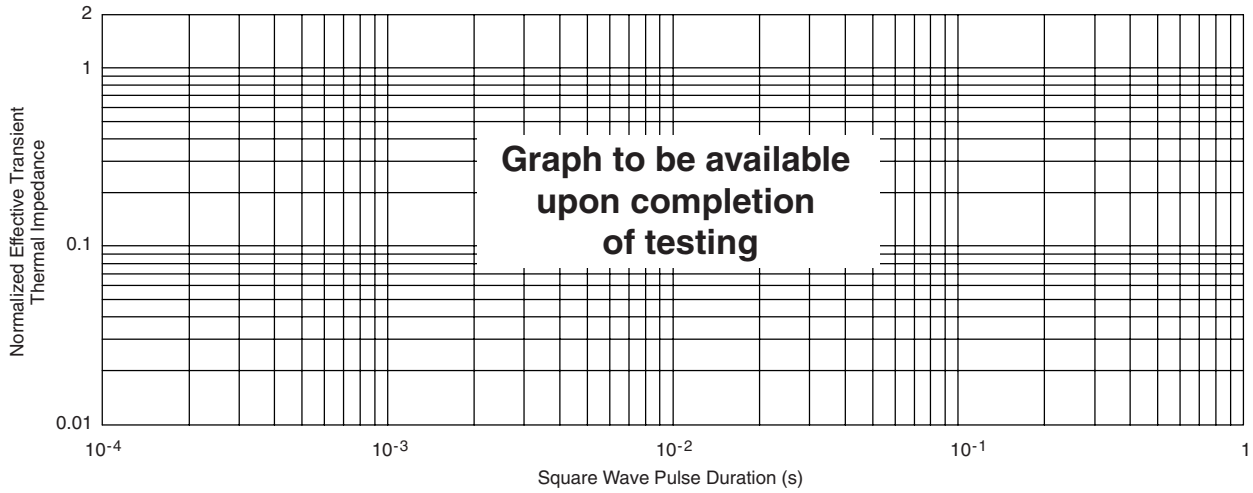

**Normalized Thermal Transient Impedance, Junction-to-Case**

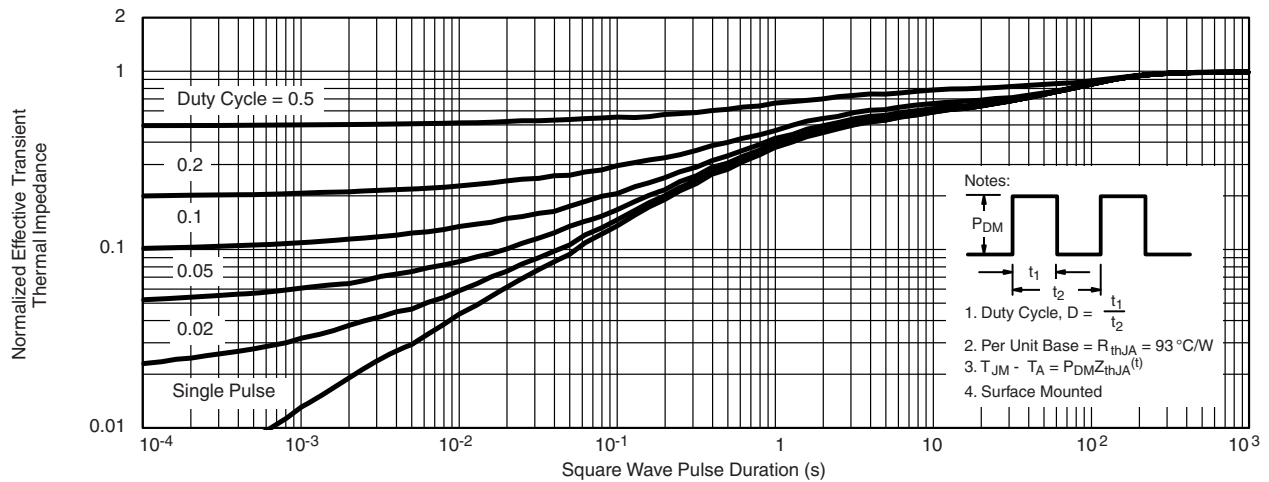

**Normalized Thermal Transient Impedance, Junction-to-Ambient**

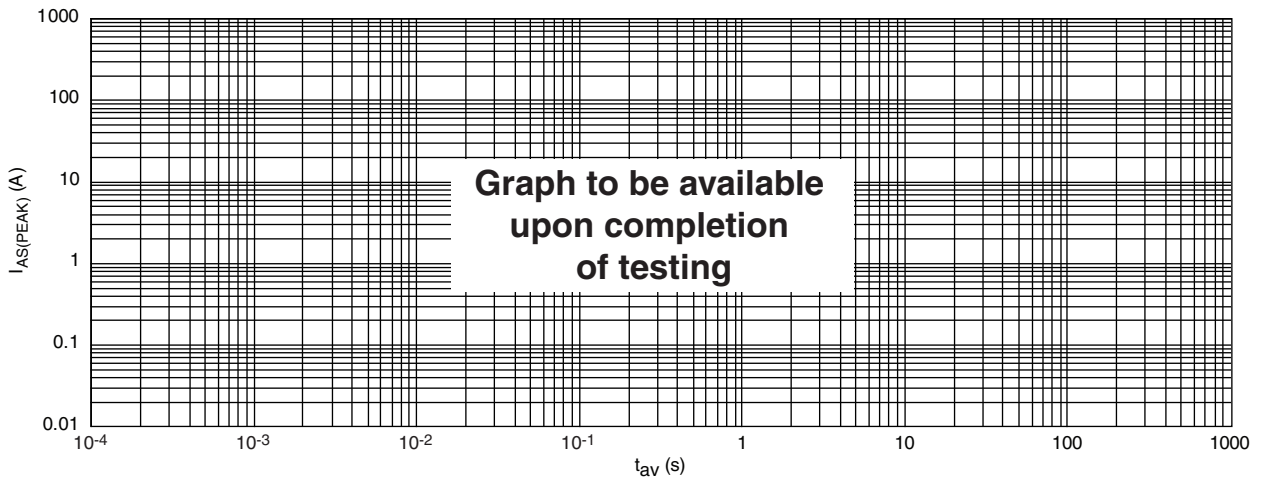

**Single Pulse Avalanche Current (Peak) vs. Time in Avalanche**

**THERMAL RATINGS**  $T_A = 25\text{ }^\circ\text{C}$ , unless otherwise noted

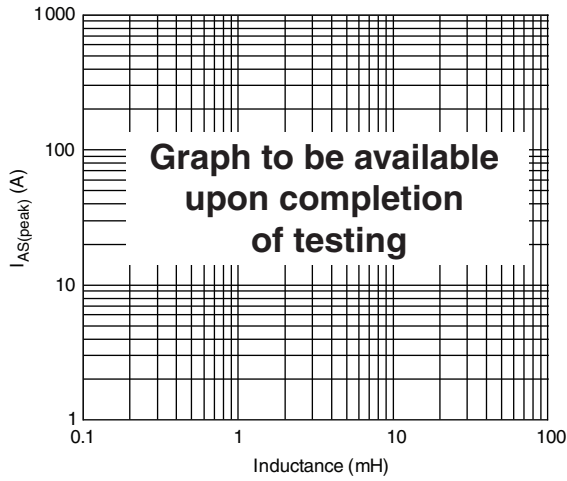

**Single Pulse Avalanche Current (Peak) vs. Inductance**

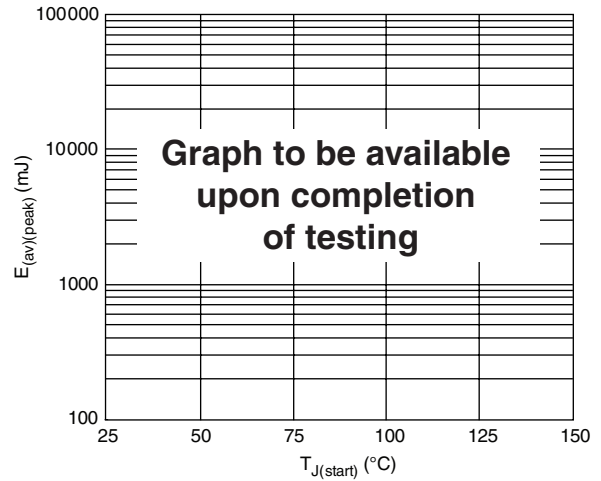

**Single Pulse Avalanche Energy (Peak) vs.  $T_{J(\text{start})}$**

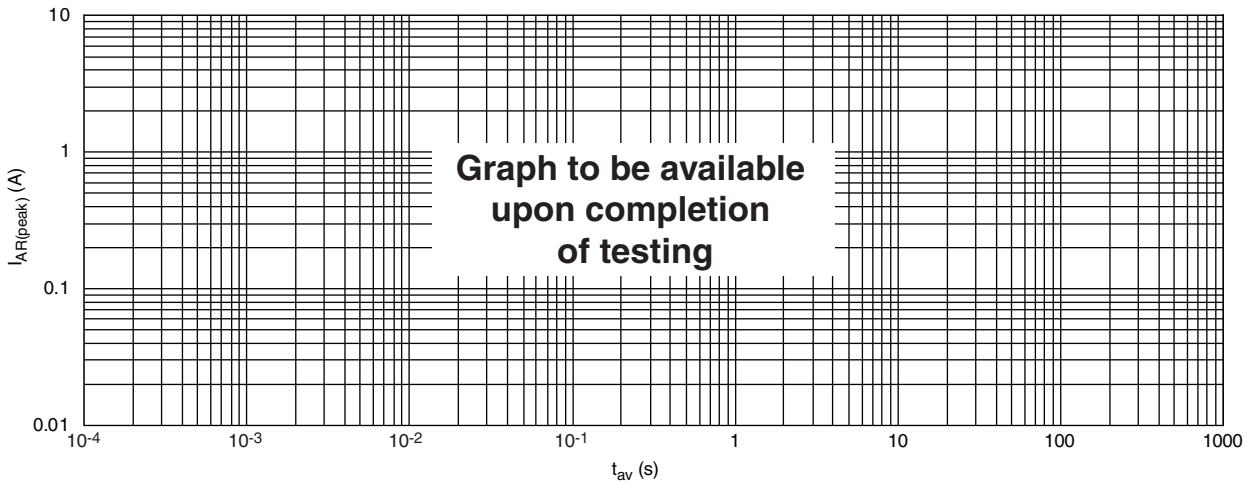

**Repetitive Avalanche Current (Peak) vs. Time in Avalanche at  $T_A = 25\text{ }^\circ\text{C}$**



**THERMAL RATINGS**  $T_A = 25\text{ }^\circ\text{C}$ , unless otherwise noted

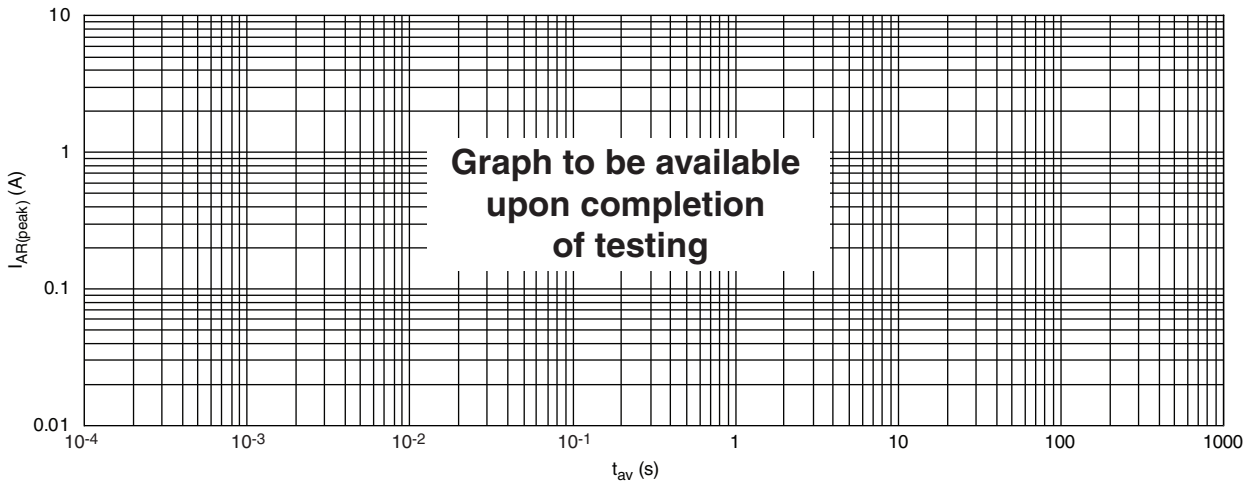

**Repetitive Avalanche Current (Peak) vs. Time in Avalanche at  $T_A = 150\text{ }^\circ\text{C}$**

**Note**

The characteristics shown in the six graphs

- Normalized Transient Thermal Impedance Junction to Ambient ( $25\text{ }^\circ\text{C}$ )
- Single Pulse Avalanche Current (Peak) vs. Time in Avalanche
- Single Pulse Avalanche Current (Peak) vs. Inductance
- Single Pulse Avalanche Energy (Peak) vs.  $T_{J(\text{start})}$
- Repetitive Avalanche Current (Peak) vs. Time in Avalanche at  $T_A = 25\text{ }^\circ\text{C}$
- Repetitive Avalanche Current (Peak) vs. Time in Avalanche at  $T_A = 150\text{ }^\circ\text{C}$

are given for general guidelines only to enable the user to get a "ball park" indication of part capabilities. The data are extracted from single pulse transient thermal impedance characteristics which are developed from empirical measurements. The latter is valid for the part mounted on printed circuit board - FR4, size 1" x 1" x 0.062", double sided with 2 oz. copper, 100 % on both sides. The part capabilities can widely vary depending on actual application parameters and operating conditions.

*Vishay Siliconix maintains worldwide manufacturing capability. Products may be manufactured at one of several qualified locations. Reliability data for Silicon Technology and Package Reliability represent a composite of all qualified locations. For related documents such as package/tape drawings, part marking, and reliability data, see <http://www.vishay.com/ppg?74499>.*



## Disclaimer

All product specifications and data are subject to change without notice.

Vishay Intertechnology, Inc., its affiliates, agents, and employees, and all persons acting on its or their behalf (collectively, "Vishay"), disclaim any and all liability for any errors, inaccuracies or incompleteness contained herein or in any other disclosure relating to any product.

Vishay disclaims any and all liability arising out of the use or application of any product described herein or of any information provided herein to the maximum extent permitted by law. The product specifications do not expand or otherwise modify Vishay's terms and conditions of purchase, including but not limited to the warranty expressed therein, which apply to these products.

No license, express or implied, by estoppel or otherwise, to any intellectual property rights is granted by this document or by any conduct of Vishay.

The products shown herein are not designed for use in medical, life-saving, or life-sustaining applications unless otherwise expressly indicated. Customers using or selling Vishay products not expressly indicated for use in such applications do so entirely at their own risk and agree to fully indemnify Vishay for any damages arising or resulting from such use or sale. Please contact authorized Vishay personnel to obtain written terms and conditions regarding products designed for such applications.

Product names and markings noted herein may be trademarks of their respective owners.