



Chipsmall Limited consists of a professional team with an average of over 10 year of expertise in the distribution of electronic components. Based in Hongkong, we have already established firm and mutual-benefit business relationships with customers from,Europe,America and south Asia,supplying obsolete and hard-to-find components to meet their specific needs.

With the principle of “Quality Parts,Customers Priority,Honest Operation,and Considerate Service”,our business mainly focus on the distribution of electronic components. Line cards we deal with include Microchip,ALPS,ROHM,Xilinx,Pulse,ON,Everlight and Freescale. Main products comprise IC,Modules,Potentiometer,IC Socket,Relay,Connector.Our parts cover such applications as commercial,industrial, and automotives areas.

We are looking forward to setting up business relationship with you and hope to provide you with the best service and solution. Let us make a better world for our industry!



Contact us

Tel: +86-755-8981 8866 Fax: +86-755-8427 6832

Email & Skype: info@chipsmall.com Web: www.chipsmall.com

Address: A1208, Overseas Decoration Building, #122 Zhenhua RD., Futian, Shenzhen, China



Sharpi Wi-Fi Antenna

Part No. SRC5G027

ceriiANT[®]

Product Specification

1. Features

- Antenna for 4.9 – 5.9 GHz applications: Wi-Fi 802.11a/h//j/n/p/ac[®] including vehicle to vehicle (V2X) applications
- Maintains high performance on device: DFI (Designed For Integration)
- Ultra-compact ceramic solution
- SMD mounting
- Supplied on Tape and Reel

2. Description

Sharpi is intended for use with 5G Wi-Fi applications. Only requires a small ground plane. Ideal for single and MIMO antenna systems. This product specification shows the performance of the antenna over the frequency range 4.9-5.9GHz.

3. Applications

- Access Points
- Portable Devices
- PC-cards
- Set-Top-Box
- Network Devices
- Wearable devices
- V2X networks
- MIMO Systems
- IP Cameras

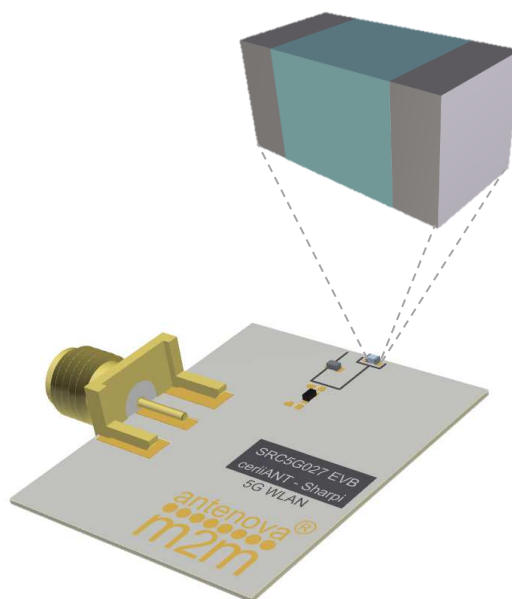

4. Part Number

Sharpi: SRC5G027

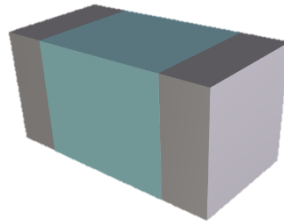

5. General Data

Product name	Sharpi
Part Number	SRC5G027
Frequency	4.9-6.0GHz
Polarization	Linear
Operating temperature	-40°C to 125°C
Impedance with matching	50 Ω
Weight	< 0.015 g
Antenna type	SMD
Dimensions	1.0 x 0.5 x 0.5 (mm)
Footprint area	5.0 x 3.0 (mm)

6. RF Characteristics

	Typical performance	Conditions
Peak gain	3.50dBi	4.9 – 5.9 GHz frequency range All data measured on Antenova's evaluation PCB Part No. SRC5G027-U1
Average gain	-2.50dBi	
Average efficiency	>60%	
Maximum return loss	-6.0dB	
Maximum VSWR	3.0:1	

7. RF Performance

7.1 Return Loss

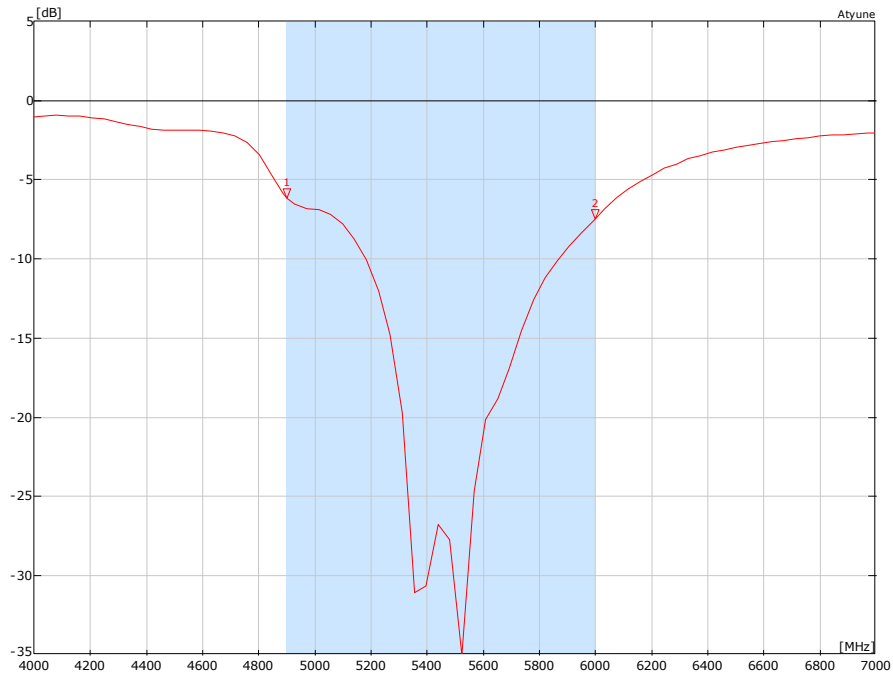

7.2 VSWR

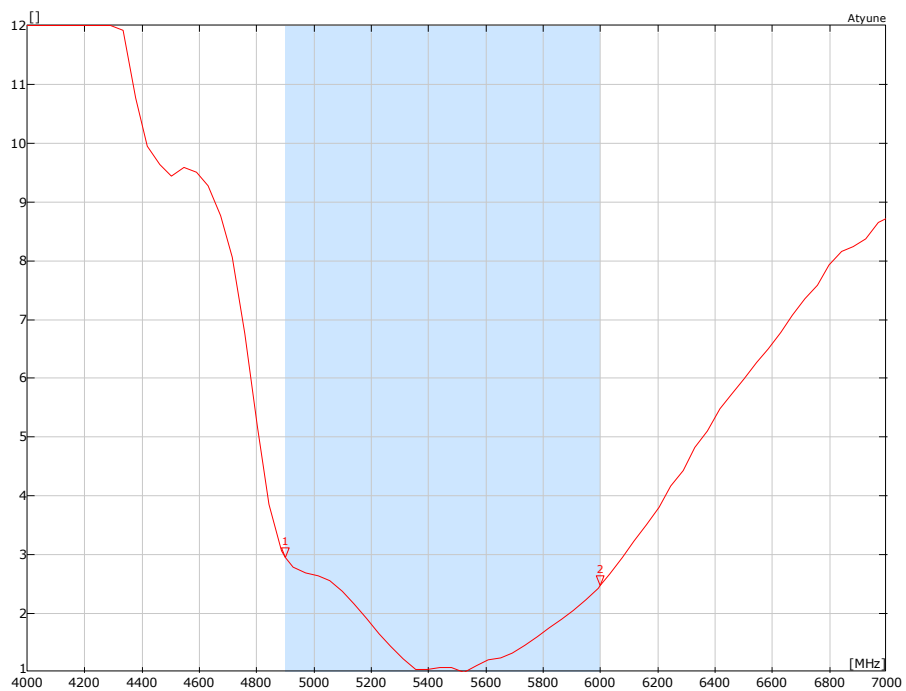

7.3 Antenna patterns

7.3.1 4900 MHz – 5900 MHz

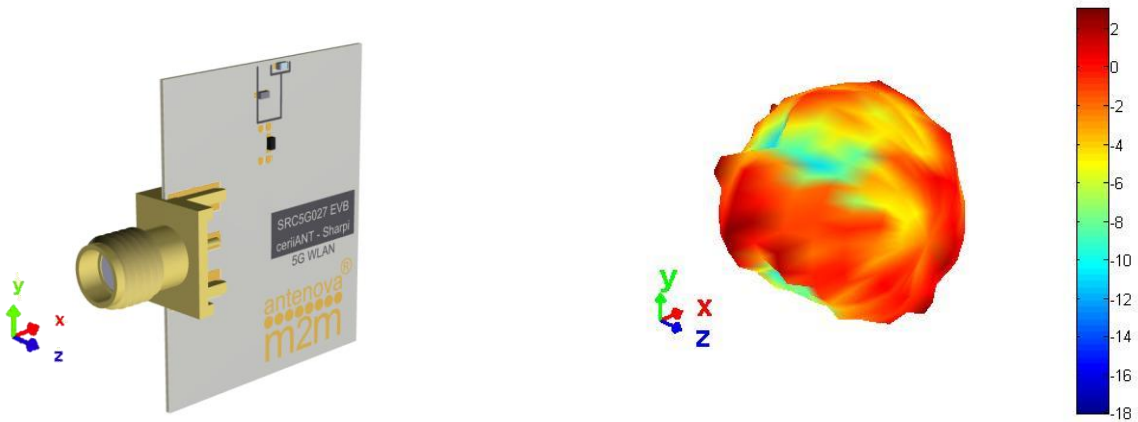

3D pattern at 5.46GHz

Drag to rotate pattern and PCB by using Adobe Reader
(Click to Activate)

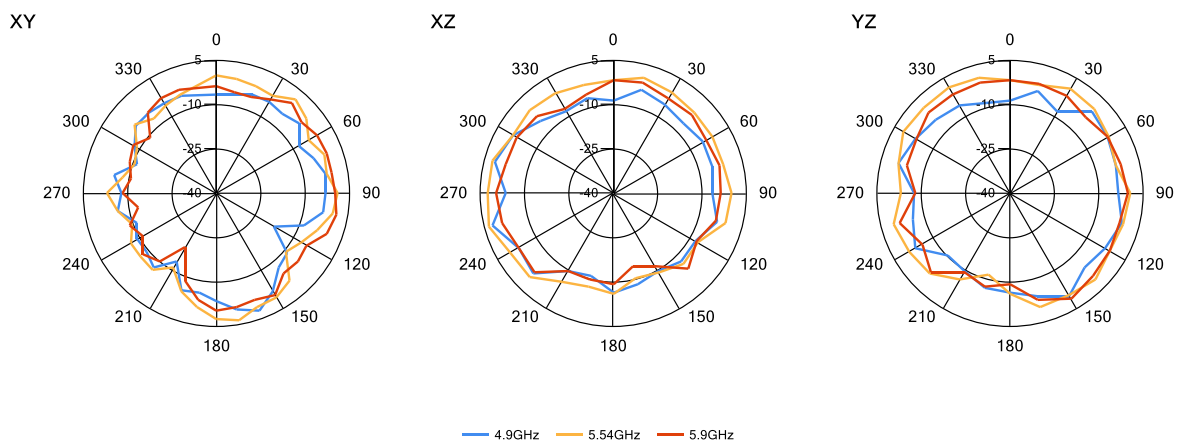

8. Antenna Dimensions

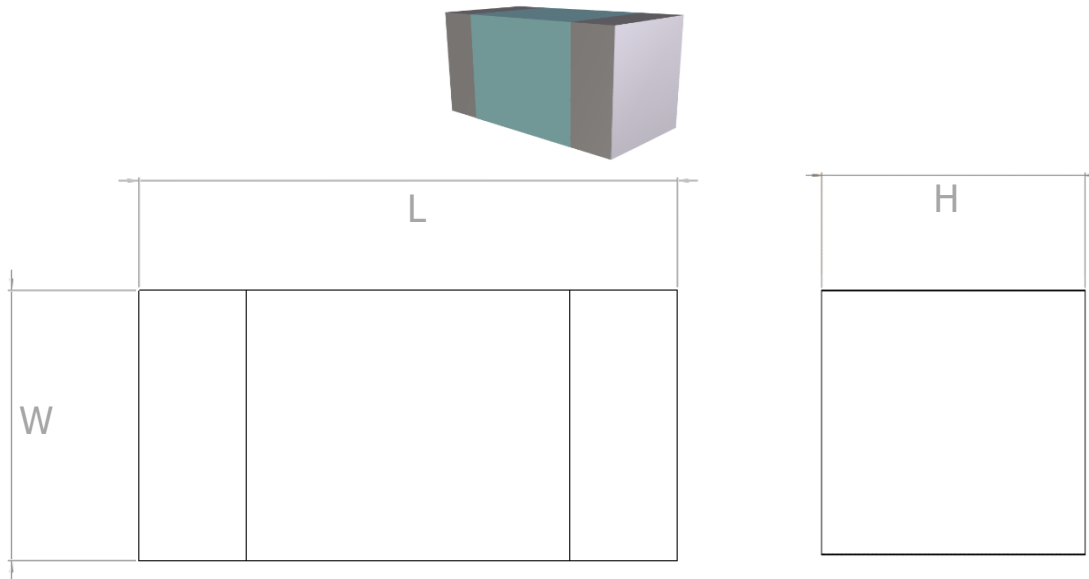

L	W	H
Length	Width	Height
1.0 ±0.1	0.5 ±0.1	0.5 ±0.1

All dimensions in mm

9.0 Antenna footprint

The recommended host PCB footprint is below.

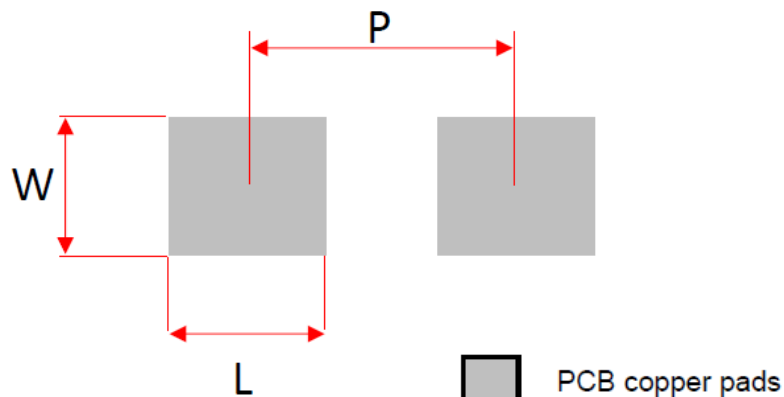

L	W	P
Length	Width	Height
0.6	0.5	1.0

All dimensions in mm

10.0 Schematic

The circuit for the antenna and the matching components is below. The RF feed connection and GND connections are critical to the function of the antenna, and must be followed as shown. This circuit can be used for the circuit capture of the host PCB.

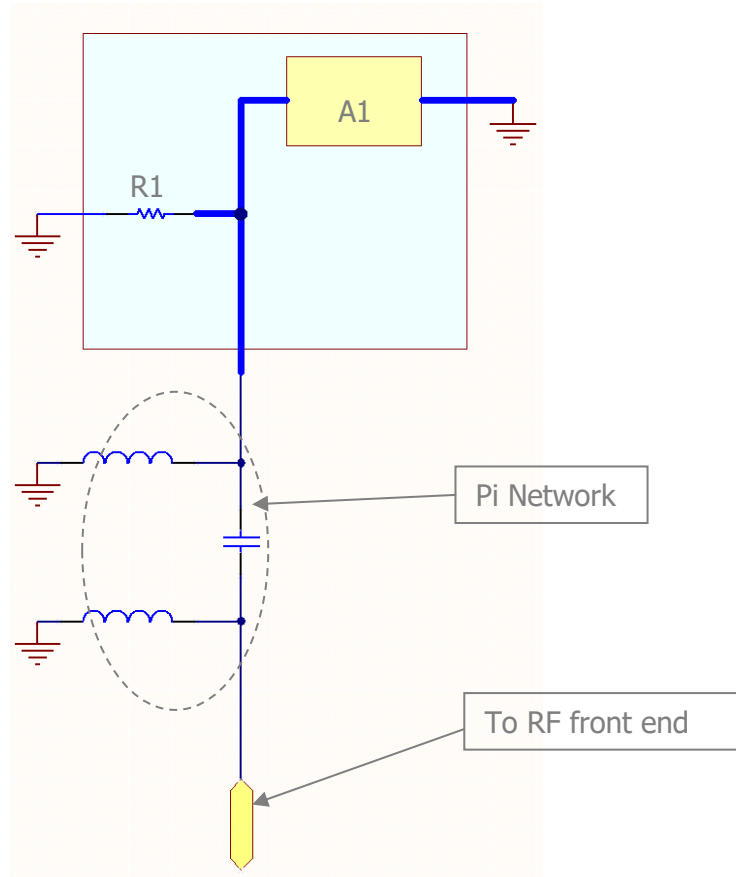

A1	Antenna (SRC5G027)
R1	Tuning Component

11. Electrical Interface

11.1 Transmission Line

All transmission lines should be designed to have a characteristic impedance of 50Ω.

- The length of the transmission lines should be kept to a minimum
- Any other parts of the RF system like transceivers, power amplifiers, etc, should also be designed to have an impedance of 50 Ω

Once the material for the PCB has been chosen (PCB thickness and dielectric constant), a coplanar transmission line can easily be designed using any of the commercial software packages for transmission line design. For the chosen PCB thickness, copper thickness and substrate dielectric constant, the program will calculate the appropriate transmission line width and gaps on either side of the feed.

11.2 Matching Circuit

The antenna requires a matching circuit that must be optimized for each product. The matching circuit will require up to three components and the following pad layout should be designed into the device so the correct circuit can be installed.

The Pi matching network must be placed close to the antenna feed to ensure it is more effective in tuning the antenna.

An additional tuning component is designed in to aid the tuning of the antenna. This is default not fitted.

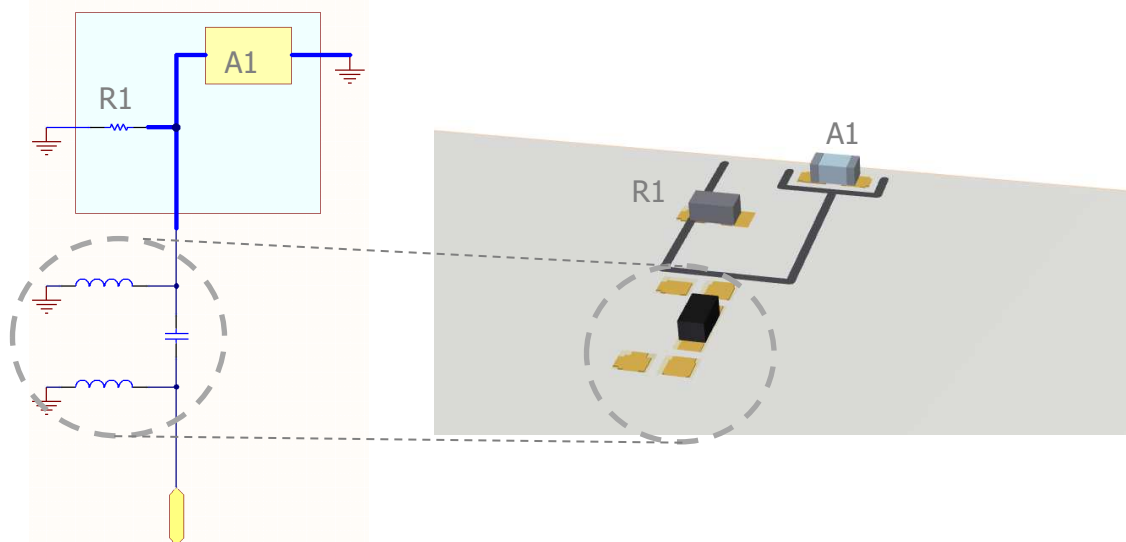

11.3 Host PCB Layout

The host PCB must ensure the footprint and clearance meets the antenna specification. The layout shown forms an integral part of the antenna, and any deviation from this will result in sub optimal performance. It is best that the copper trace layout is imported from the CAD files which are available from the Antenna website.

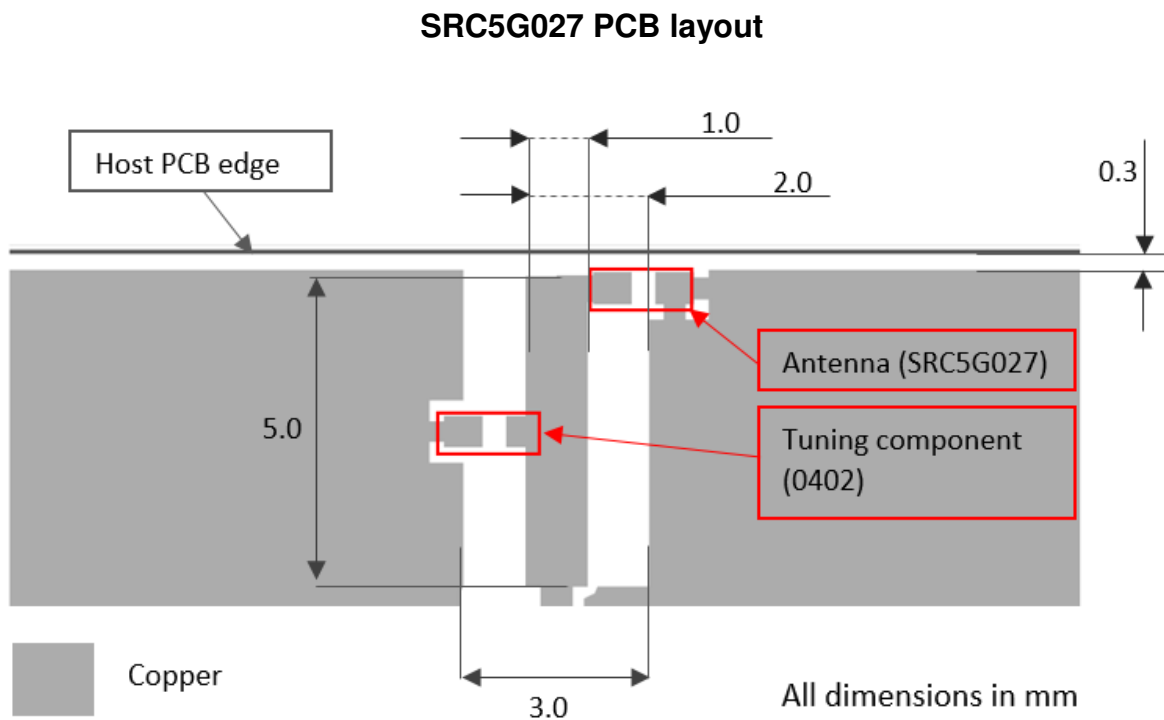

Below shows the PCB layout without solder mask for illustration purposes only.

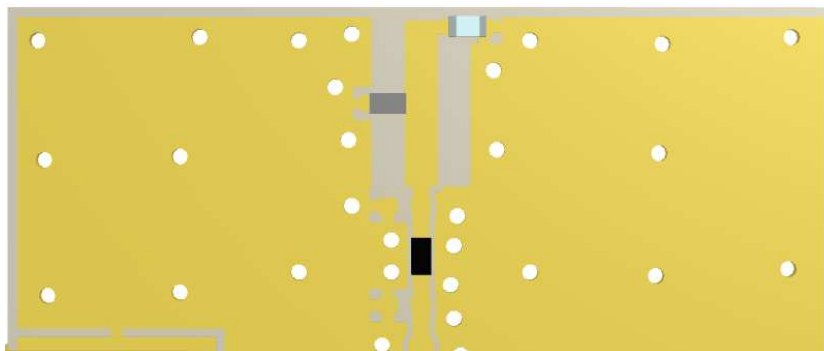

12.0 Antenna Placement

The antenna should be placed close along the PCB edge. This is best near to the corner of the host for optimal performance.

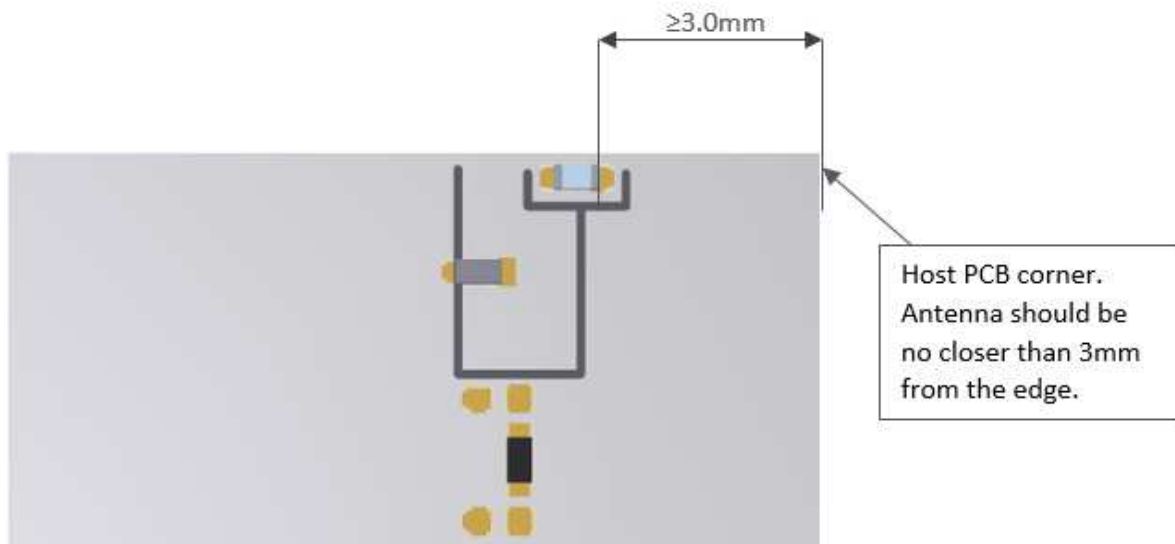

13.0 Reference Board

The reference board has been designed for evaluation purposes of SRC5G027 includes a SMA female connector.



To order a reference board contact sales@antenna-m2m.com
Please state if single or two antenna EVB is required.

14. Soldering

This antenna is suitable for lead free soldering.

The reflow profile should be adjusted to suit the device, oven and solder paste, while observing the following conditions:

- The maximum temperature should not exceed 240 °C
- However for lead free soldering, a maximum temperature of 255 °C for no more than 20 seconds is permitted.
- The antenna should not be exposed to temperatures exceeding 120 °C more than 3 times during the soldering process.

15. Hazardous Material Regulation Conformance

The antenna has been tested to conform to RoHS requirements. A certificate of conformance is available from Antenova M2M's website.

16. Packaging

16.1 Optimal Storage Conditions

Temperature	-10°C to 40°C
Humidity	Less than 75% RH
Shelf life	24 Months
Storage place	Away from corrosive gas and direct sunlight
Packaging	Reels should be stored in unopened sealed manufacturer's plastic packaging.

Note: Storage of open reels of antennas is not recommended due to possible oxidization of pads on antennas. If short term storage is necessary, then it is highly recommended that the bag containing the antenna reel is re-sealed and stored in like storage conditions as in above table.

16.2 Tape Characteristics

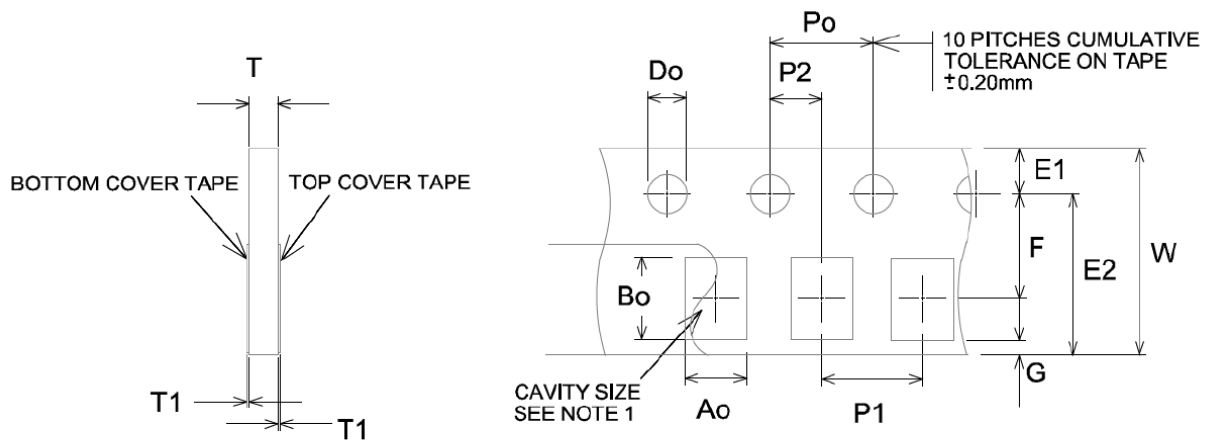

All dimensions in mm

Do	Ao	Bo	P0	P1	P2
1.50 +0.1	See note	See note	4.00 ± 0.1	4.00 ± 0.1	2.00 ± 0.05

E1	E2	W	K0	F	G
1.75 ± 0.1	6.25 ± 0.1	8.00 ± 0.3	1.40 ± 0.1	3.50 ± 0.05	0.75 min

Notes:

The cavity defined by Ao, Bo and T shall be configured to provide sufficient clearance surrounding the antenna so that:

- The component does not protrude beyond either surface of the carrier
- The component can be removed from the cavity in a vertical direction without mechanical restriction after the top cover tape has been removed
- Rotation of the component is limited to 20 degrees maximum.
- Lateral movement of the component is restricted to 0.5mm maximum.

16.3 Reel Dimensions

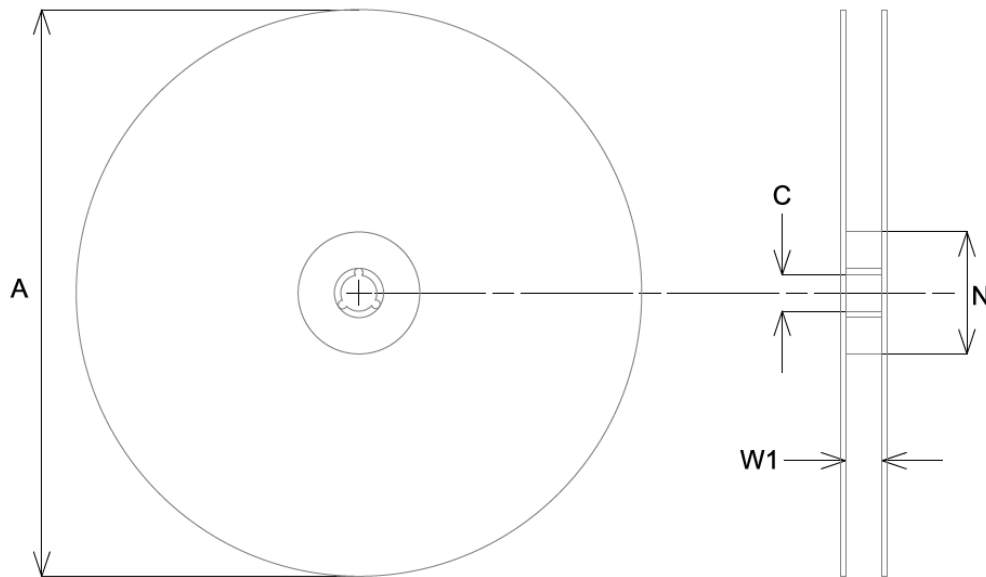

A	C	N	W1
330.0 ± 2.0	13.0 ± 0.5	60.0	8.4.0

All dimensions in mm

Quantity	Leading Space	Trailing Space
10,000 pcs / reel	16 blank holders	24 blank holders

16.4 Box Dimensions

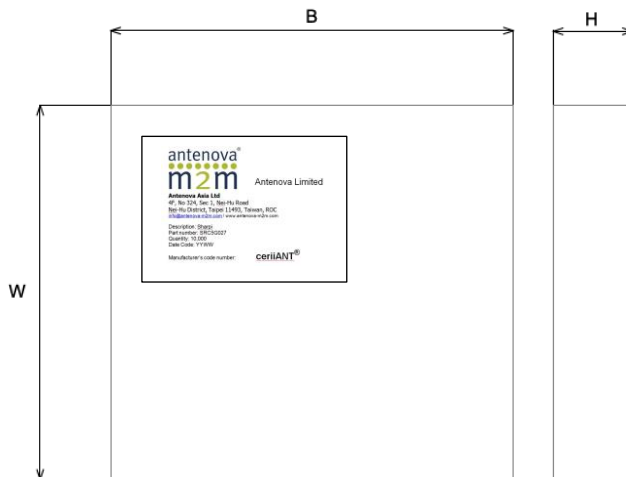

Width (W)	Breadth (B)	Thickness (H)
340mm	350mm	47mm

16.5 Bag Properties

Reels are supplied in protective plastic packaging.

16.6 Reel Label Information

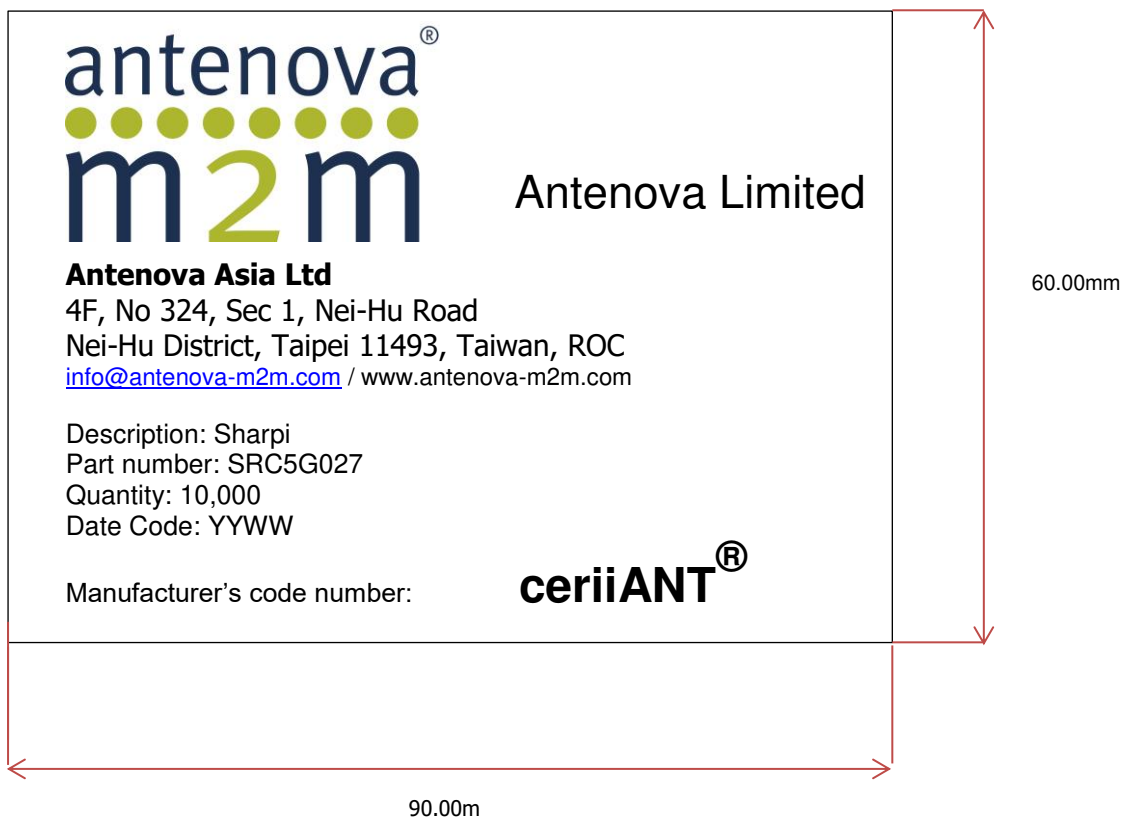

Antennas for Wireless M2M Applications



www.antenova-m2m.com

Corporate Headquarters

Antenova Limited
2nd Floor Titan Court
3 Bishop Square
Hatfield
AL10 9NA
UK

Tel: +44 1223 810600

Email: sales@antenova-m2m.com

North America Headquarters

Antenova Limited
100 Brush Creek Road, Suite 103
Santa Rosa
California 95404
USA

Tel: +1 707 890 5202

Email: sales@antenova-m2m.com

Asia Headquarters

Antenova Asia Limited
4F, No. 324, Sec. 1, Nei-Hu Road
Nei-Hu District
Taipei 11493
Taiwan, ROC

Tel: +886 (0) 2 8797 8630

Fax: +886 (0) 2 8797 6890

Email: sales@antenova-m2m.com

Copyright© Antenova Ltd. All Rights Reserved. Antenova®, Antenova M2M®, gigaNOVA®, the Antenova product family names, and the Antenova and Antenova M2M logos are trademarks and/or registered trademarks of Antenova Ltd. Any other names and/or trademarks belong to their respective companies.

The materials provided herein are believed to be reliable and correct at the time of printing. Antenova does not warrant the accuracy or completeness of the information, text, graphics or other items contained within this information. Antenova further assumes no responsibility for the use of this information, and all such information shall be entirely at the user's risk.



Certificate No: 4598

Antennas for Wireless M2M Applications