



Chipsmall Limited consists of a professional team with an average of over 10 year of expertise in the distribution of electronic components. Based in Hongkong, we have already established firm and mutual-benefit business relationships with customers from,Europe,America and south Asia,supplying obsolete and hard-to-find components to meet their specific needs.

With the principle of “Quality Parts,Customers Priority,Honest Operation,and Considerate Service”,our business mainly focus on the distribution of electronic components. Line cards we deal with include Microchip,ALPS,ROHM,Xilinx,Pulse,ON,Everlight and Freescale. Main products comprise IC,Modules,Potentiometer,IC Socket,Relay,Connector.Our parts cover such applications as commercial,industrial, and automotives areas.

We are looking forward to setting up business relationship with you and hope to provide you with the best service and solution. Let us make a better world for our industry!



## Contact us

Tel: +86-755-8981 8866 Fax: +86-755-8427 6832

Email & Skype: info@chipsmall.com Web: www.chipsmall.com

Address: A1208, Overseas Decoration Building, #122 Zhenhua RD., Futian, Shenzhen, China



DATE	REV	ECN	APP'D. BY
-	X0	-	-
2-08-11	A0	9140	DHG
5-25-12	A1	9480	SMN
1-12-15	A2	10178	TRM

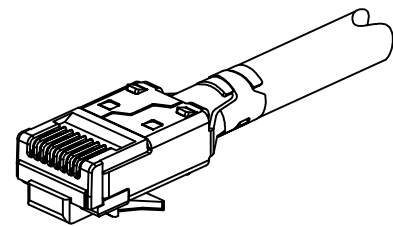

ISOMETRIC VIEW OF TERMINATED PLUG

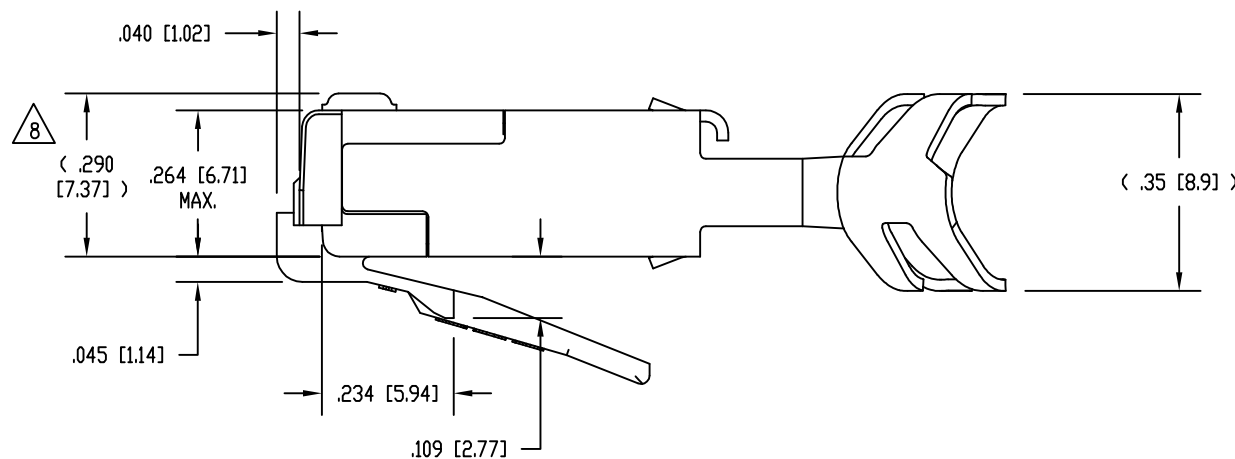
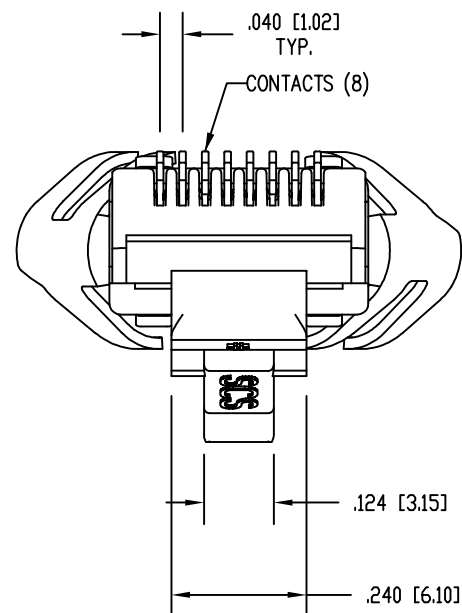
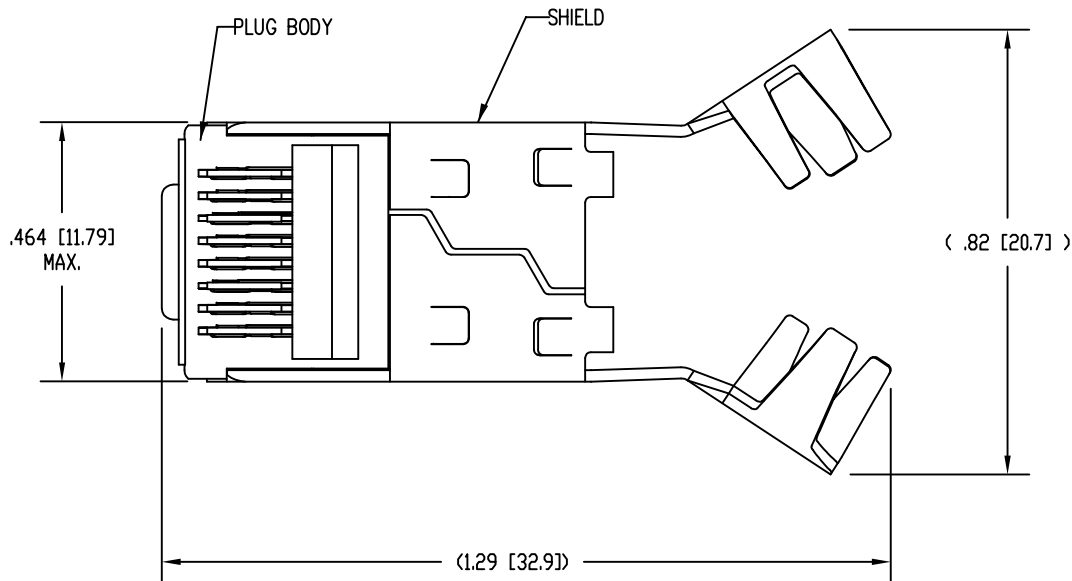

NOTES:

- PLUG KIT CONSISTS OF:  
PRE-INSERTED PLUG BODY WITH SHIELD - 39200-317  
LOAD BAR - 39100-847  
WIRE ALIGNER - 39200-893
- MATERIALS:  
PLUG BODY: CLEAR POLYCARBONATE, UL 94-V0  
LOAD BAR: BLACK POLYCARBONATE, UL 94-V0  
WIRE ALIGNER: CLEAR POLYCARBONATE, UL 94-V0  
CONTACTS: COPPER ALLOY, SELECTIVE GOLD PLATING  
SHIELD: COPPER ALLOY, NICKEL PLATE
- FOR PRODUCT SPECIFICATION SEE PRO26-01.
- CONTACTS TERMINATE SOLID OR STRANDED CONDUCTORS BETWEEN .037 [0.94] TO .042 [1.07] OUTSIDE DIAMETER OF INSULATION.
- CRIMP IS FOR CABLES WITH OUTSIDE NOMINAL DIAMETERS OF .230 [5.84] TO .250 [6.35].
- PRODUCT DESIGNED FOR CATEGORY 6A APPLICATIONS.
- DIMENSIONS AND TOLERANCES COMPLY WITH TIA-1096 STANDARD FORMERLY FCC/CFR 47, PART 68.

△ 8 TERMINATED PLUG HEIGHT: .237 [6.02] ±.005 [0.13].

50 MICRO-INCHES [0.76um]	SS-39200-023
CONTACT PLATING IN MATING AREA	PART NUMBER

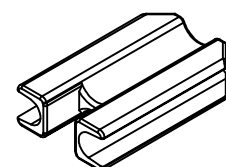

WIRE ALIGNER  
39200-893

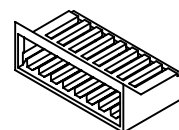

LOAD BAR  
39100-847

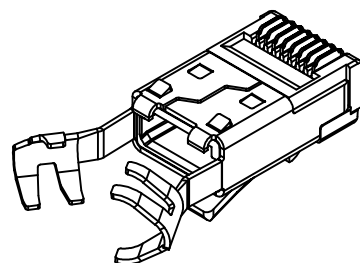

PRE-INSERTED PLUG BODY WITH SHIELD  
39200-317



THIRD ANGLE PROJECTION

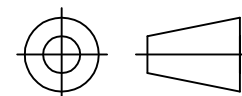

DO NOT SCALE DRAWING  
DRAWING IS SUBJECT TO CHANGE WITHOUT NOTICE

DIMENSIONS: INCHES [METRIC]  
UNLESS OTHERWISE SPECIFIED TOLERANCES ARE ±.005 [0.13] ANGLES ARE ± 1°

SHEET NO. 1 OF 1



11118 Susquehanna Trail South  
Glen Rock, PA 17327-9199  
(717) 235-7512

http://www.stewartconnector.com

TITLE: 8 CONDUCTOR, 8 POSITION SHIELDED CAT 6A PLUG, WITH LOAD BAR, AND WIRE ALIGNER, .250 MAX CABLE

THIS DRAWING AND THE SUBJECT MATTER SHOWN THEREON ARE CONFIDENTIAL AND THE PROPRIETARY PROPERTY OF STEWART CONNECTOR AND SHALL NOT BE REPRODUCED, COPIED, OR USED IN ANY MANNER WITHOUT PRIOR WRITTEN CONSENT OF STEWART CONNECTOR. THIS PRODUCT MAY BE PROTECTED BY ONE OR MORE OF THE FOLLOWING US PATENTS: 5628647 6402559 6409535 6524128 7753717 8033863 OTHER PATENTS MAY BE PENDING.

DRN BY: DHG	DATE 8-17-10
APPD BY: TRM	DATE 8-24-10
DWG NO. CT390076	REV. A2