



Chipsmall Limited consists of a professional team with an average of over 10 year of expertise in the distribution of electronic components. Based in Hongkong, we have already established firm and mutual-benefit business relationships with customers from,Europe,America and south Asia,supplying obsolete and hard-to-find components to meet their specific needs.

With the principle of "Quality Parts,Customers Priority,Honest Operation,and Considerate Service",our business mainly focus on the distribution of electronic components. Line cards we deal with include Microchip,ALPS,ROHM,Xilinx,Pulse,ON,Everlight and Freescale. Main products comprise IC,Modules,Potentiometer,IC Socket,Relay,Connector.Our parts cover such applications as commercial,industrial, and automotives areas.

We are looking forward to setting up business relationship with you and hope to provide you with the best service and solution. Let us make a better world for our industry!



Contact us

Tel: +86-755-8981 8866 Fax: +86-755-8427 6832

Email & Skype: info@chipsmall.com Web: www.chipsmall.com

Address: A1208, Overseas Decoration Building, #122 Zhenhua RD., Futian, Shenzhen, China



DATE	REV.	ECN	APP'D BY
-	A0	-	

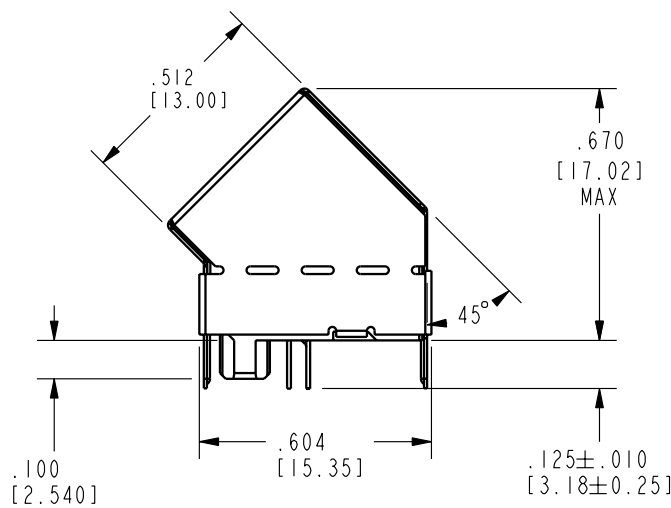
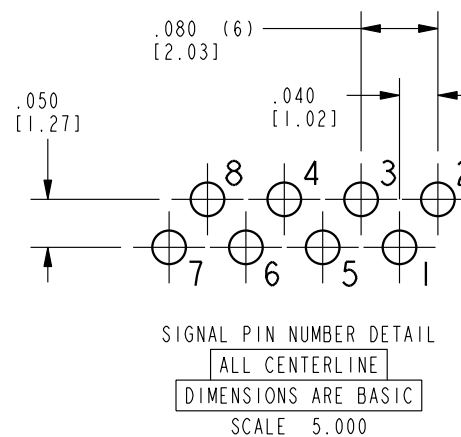
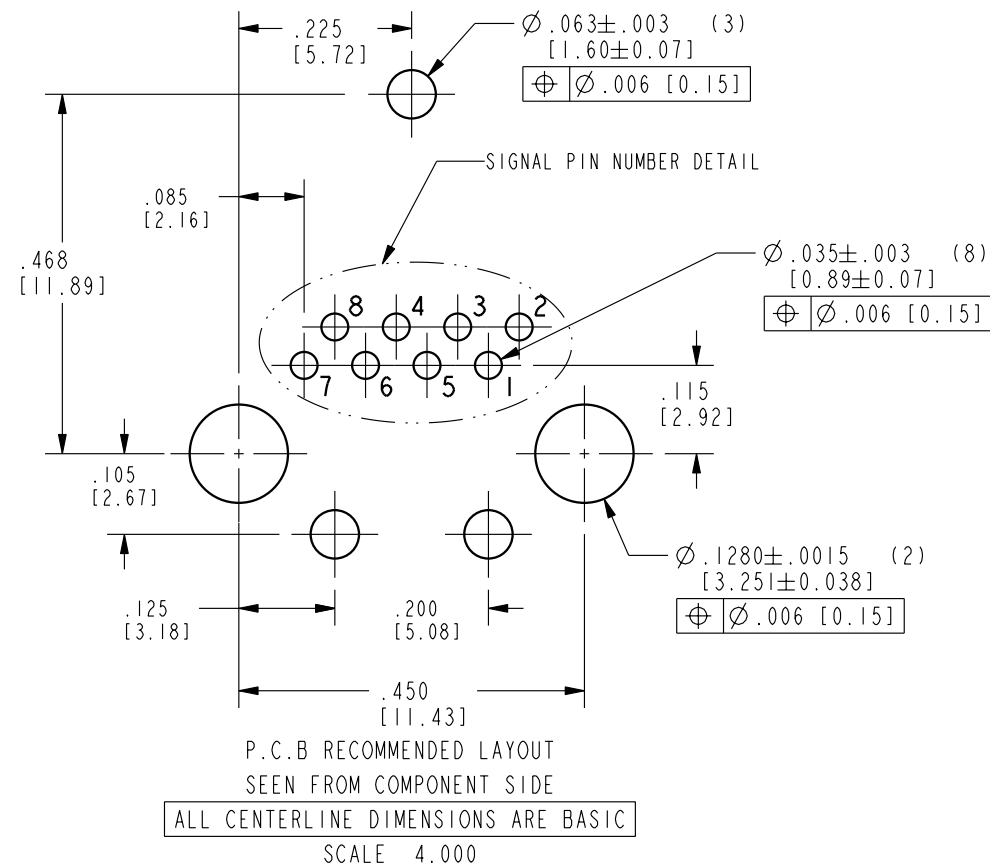
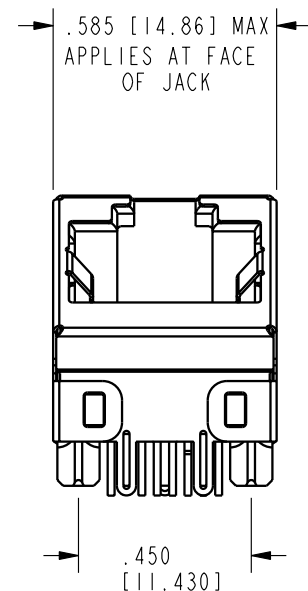
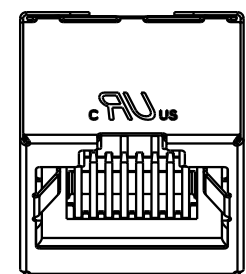
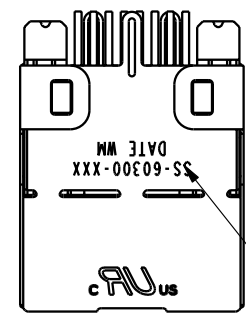

NOTES:

- CONNECTOR MATERIALS:
HOUSING: THERMOPLASTIC UL94 V-0
CONTACTS/SHIELD: COPPER ALLOY
SHIELD PLATING: NICKEL OR TIN
CONTACT PLATING: SELECTIVE GOLD IN CONTACT AREA
SEE CHART FOR PART NUMBER
- THE ASSEMBLY SHALL WITHSTAND 1000 VDC BETWEEN CONTACTS FOR 60 SECONDS, MINIMUM.
- HIGH TEMPERATURE PLASTIC: WAVE SOLDER COMPATIBLE TO 260°C.
- FOR PRODUCT SPECIFICATION SEE PR033-01.
- LOGO, PART NUMBER AND DATE CODE LOCATED APROX. IN THIS AREA.
- FOR PROPER JACK FUNCTION AND PERFORMANCE, TIA-1096 COMPLIANT PLUGS MUST BE USED.

50 MICRO-INCHES [1.27um]	SS-60300-081
CONTACT PLATING IN MATING AREA	PART NUMBER

THIRD ANGLE PROJECTION

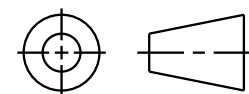

DO NOT SCALE DRAWING

DRAWING IS SUBJECT TO CHANGE WITHOUT NOTICE

DIMENSIONS: INCHES [METRIC]

UNLESS OTHERWISE SPECIFIED TOLERANCES ARE ±.005 [0.13] ANGLES ARE ±1°

SHEET NO. 1 OF 1



11118 Susquehanna Trail South
Glen Rock, PA 17327-9199
(717) 235-7512
<http://www.stewartconnector.com>

10G, 5G, 2.5G 45° ANGLE JACK, NF SHIELD

DRN BY: TRM DATE 9-1-17

APPD BY: DHG DATE 9-1-17

DWG. NO. CT600190 REV. A0

THIS DRAWING AND THE SUBJECT MATTER SHOWN THEREON ARE CONFIDENTIAL AND THE PROPRIETARY PROPERTY OF STEWART CONNECTOR AND SHALL NOT BE REPRODUCED, COPIED, OR USED IN ANY MANNER WITHOUT PRIOR WRITTEN CONSENT OF STEWART CONNECTOR. ONE OR MORE U.S. PATENTS MAY APPLY TO THIS PRODUCT. FOR DETAILS, PLEASE VISIT: [HTTP://BELFUSE.COM/STEWART/STEWART_PATENTS/](http://BELFUSE.COM/STEWART/STEWART_PATENTS/)

