



Chipsmall Limited consists of a professional team with an average of over 10 year of expertise in the distribution of electronic components. Based in Hongkong, we have already established firm and mutual-benefit business relationships with customers from,Europe,America and south Asia,supplying obsolete and hard-to-find components to meet their specific needs.

With the principle of “Quality Parts,Customers Priority,Honest Operation,and Considerate Service”,our business mainly focus on the distribution of electronic components. Line cards we deal with include Microchip,ALPS,ROHM,Xilinx,Pulse,ON,Everlight and Freescale. Main products comprise IC,Modules,Potentiometer,IC Socket,Relay,Connector.Our parts cover such applications as commercial,industrial, and automotives areas.

We are looking forward to setting up business relationship with you and hope to provide you with the best service and solution. Let us make a better world for our industry!



## Contact us

Tel: +86-755-8981 8866 Fax: +86-755-8427 6832

Email & Skype: info@chipsmall.com Web: www.chipsmall.com

Address: A1208, Overseas Decoration Building, #122 Zhenhua RD., Futian, Shenzhen, China



DATE	REV	ECN	APP'D. BY
8-21-12	B0	9579	TRM
6-18-13	B1	9786	TRM
1-16-15	B2	10208	TRM

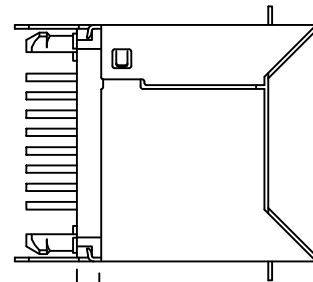

.060 [1.52]

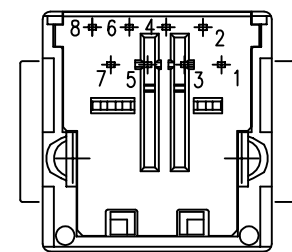

PIN POSITION LAYOUT IS IDENTICAL TO STANDARD JACKS

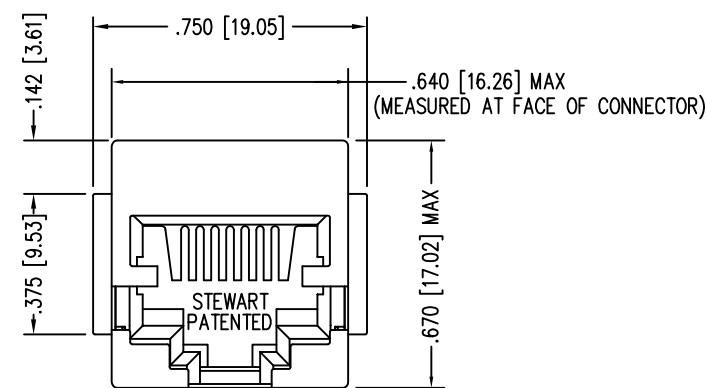
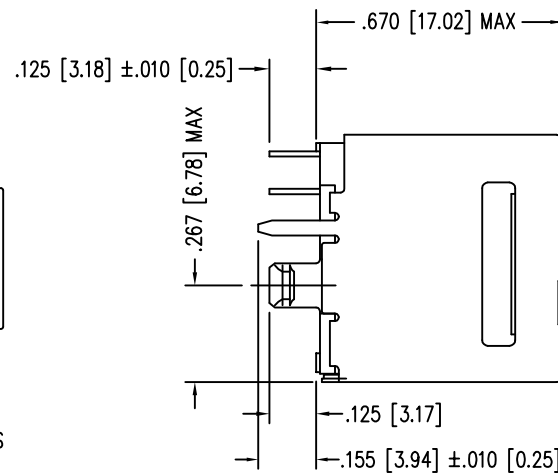

NOTES:

- CONNECTOR MATERIALS:  
HOUSING: THERMOPLASTIC UL94 V-0  
CONTACTS/SHIELD: COPPER ALLOY  
SHIELD PLATING: NICKEL OR TIN  
CONTACT PLATING: SELECTIVE GOLD IN CONTACT AREA  
SEE CHART FOR PART NUMBER
- FOR PRODUCT SPECIFICATIONS SEE PRO26-01.
- DIMENSIONS AND TOLERANCES COMPLY WITH TIA-1096 STANDARD.
- DESIGNED FOR CATEGORY 5/5e APPLICATIONS.

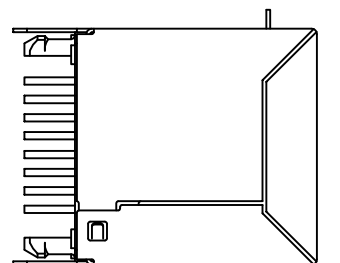

.125 [3.17]

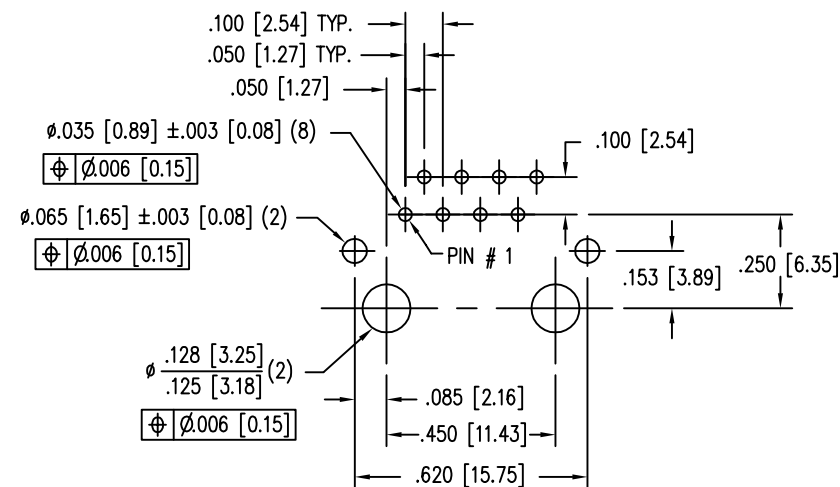

P.C.B. RECOMMENDED HOLE LAYOUT SEEN FROM COMPONENT SIDE

ALL CENTERLINE DIMENSIONS ARE BASIC.

30 MICRO-INCHES [0.76um]	SS-7188VS-A-FLS
CONTACT PLATING IN MATING AREA	PART NUMBER

THIRD ANGLE PROJECTION

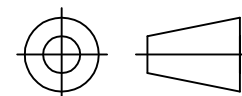

1118 Susquehanna Trail South  
Glen Rock, PA 17327-9199  
(717) 235-7512

<http://www.stewartconnector.com>

DO NOT SCALE DRAWING  
DRAWING IS SUBJECT TO CHANGE WITHOUT NOTICE

TITLE: EIGHT CONTACT, EIGHT POSITION; VERTICAL MOUNT SHIELDED CAT 5/5e JACK, FLANGE

DIMENSIONS: INCHES [METRIC]  
UNLESS OTHERWISE SPECIFIED TOLERANCES ARE ±.005 [0.13] ANGLES ARE ± 1°

THIS DRAWING AND THE SUBJECT MATTER SHOWN THEREON ARE CONFIDENTIAL AND THE PROPRIETARY PROPERTY OF STEWART CONNECTOR AND SHALL NOT BE REPRODUCED, COPIED, OR USED IN ANY MANNER WITHOUT PRIOR WRITTEN CONSENT OF STEWART CONNECTOR. THIS PRODUCT MAY BE PROTECTED BY ONE OR MORE OF THE FOLLOWING US PATENTS: 5791942 6217391 6368159 6419526 6602097 687722 6964587 7048590 7086909 7568950 7686650 OTHER PATENTS MAY BE PENDING.

DRN BY: J.A.F.	DATE 10-12-99
APPD BY: T.R.M.	DATE 10-12-99
DWG NO. CT710029	REV. B2

SHEET NO. 1 OF 1

