



Chipsmall Limited consists of a professional team with an average of over 10 year of expertise in the distribution of electronic components. Based in Hongkong, we have already established firm and mutual-benefit business relationships with customers from,Europe,America and south Asia,supplying obsolete and hard-to-find components to meet their specific needs.

With the principle of “Quality Parts,Customers Priority,Honest Operation,and Considerate Service”,our business mainly focus on the distribution of electronic components. Line cards we deal with include Microchip,ALPS,ROHM,Xilinx,Pulse,ON,Everlight and Freescale. Main products comprise IC,Modules,Potentiometer,IC Socket,Relay,Connector.Our parts cover such applications as commercial,industrial, and automotives areas.

We are looking forward to setting up business relationship with you and hope to provide you with the best service and solution. Let us make a better world for our industry!



Contact us

Tel: +86-755-8981 8866 Fax: +86-755-8427 6832

Email & Skype: info@chipsmall.com Web: www.chipsmall.com

Address: A1208, Overseas Decoration Building, #122 Zhenhua RD., Futian, Shenzhen, China



DATE	REV	ECN	APP'D. BY
6-27-06	B2	7581	TRM
10-24-07	C0	8268	TRM
6-19-12	C1	9514	SMN
1-19-15	C2	10212	TRM

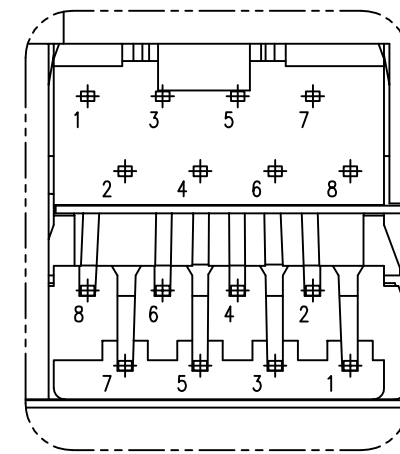
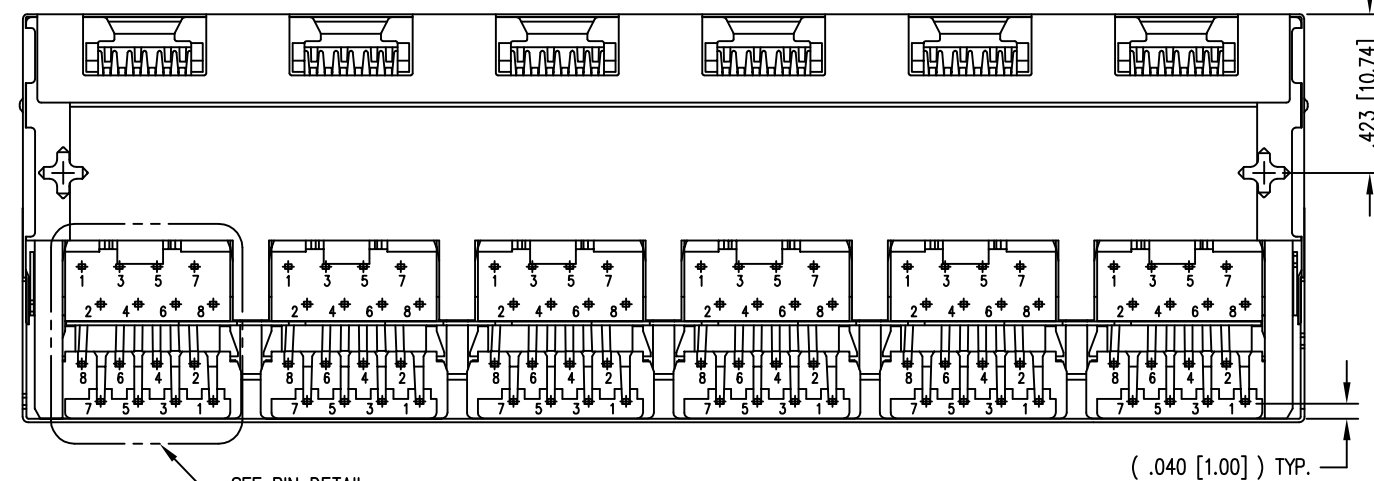
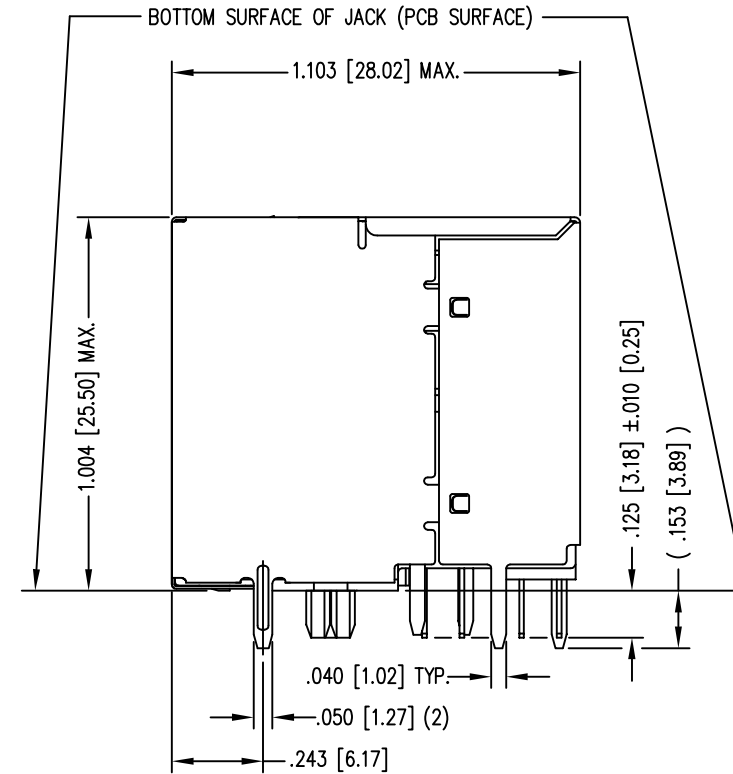
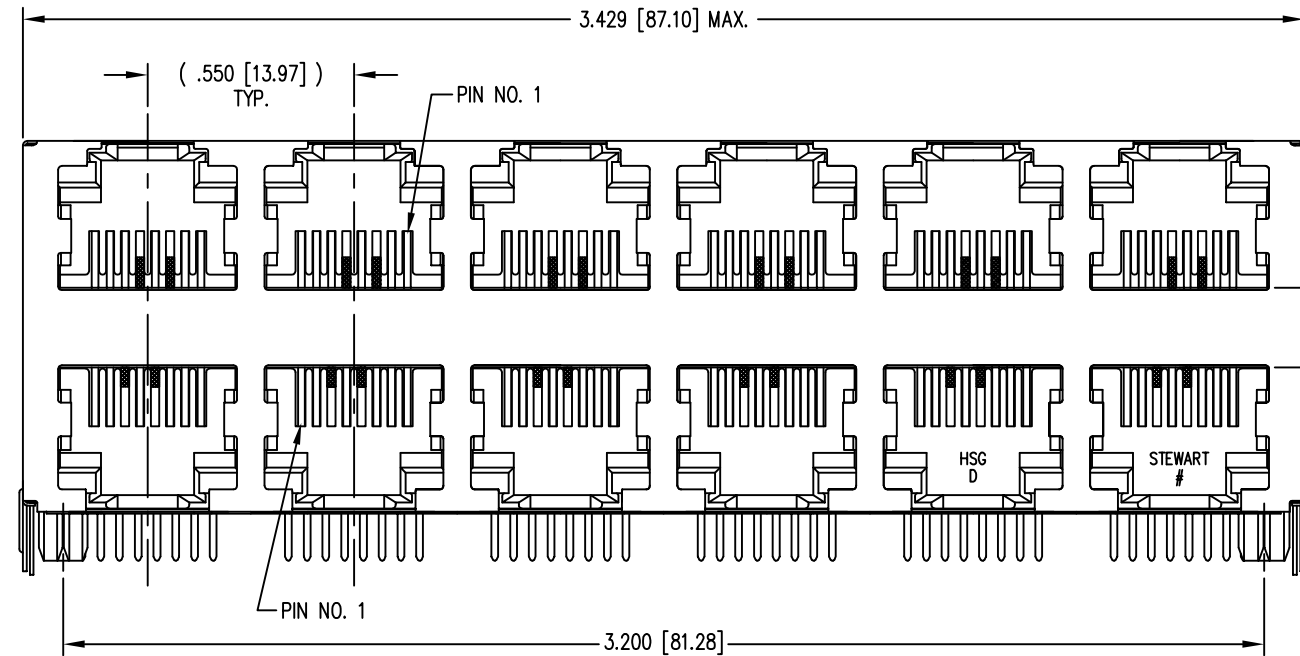

NOTES:

- CONNECTOR MATERIALS:
HOUSING: THERMOPLASTIC UL94 V-0
CONTACTS/SHIELD: COPPER ALLOY
CONTACT PLATING: SELECTIVE GOLD IN CONTACT AREA
SEE CHART FOR PART NUMBER
SHIELD PLATING: NICKEL OR TIN
- FOR PRODUCT SPECIFICATION SEE PR022-01.
- DIMENSIONS AND TOLERANCES COMPLY WITH FCC/CFR 47, PART 68.
- DESIGNED FOR CATEGORY 5/5e APPLICATIONS.

50 MICRO-INCHES [1.27um]	SS-73100-003
CONTACT PLATING IN MATING AREA	PART NUMBER

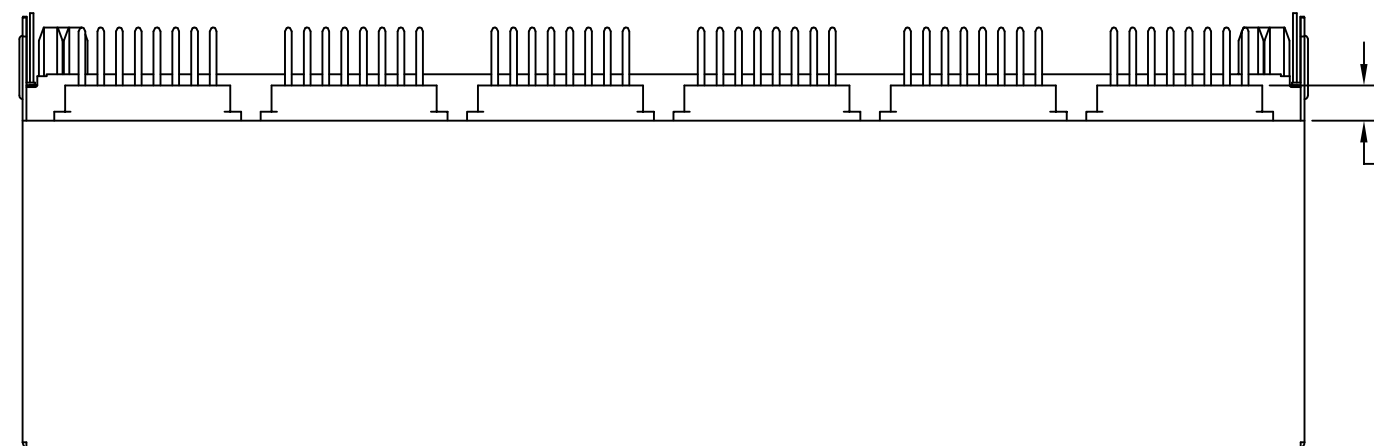

THIRD ANGLE PROJECTION

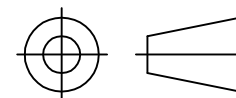

DO NOT SCALE DRAWING
DRAWING IS SUBJECT TO
CHANGE WITHOUT NOTICE

DIMENSIONS: INCHES [METRIC]
UNLESS OTHERWISE SPECIFIED
TOLERANCES ARE ±.005 [0.13]
ANGLES ARE ± 1°

SHEET NO. 1 OF 2



1118 Susquehanna Trail South
Glen Rock, PA 17327-9199
(717) 235-7512

<http://www.stewartconnector.com>

TITLE: EIGHT CONTACT, EIGHT POSITION SHIELDED STACK JACK
ENHANCED SHIELD, 12 PORT (6 ON 6)

THIS DRAWING AND THE SUBJECT MATTER SHOWN THEREON ARE
CONFIDENTIAL AND THE PROPRIETARY PROPERTY OF STEWART CONNECTOR
AND SHALL NOT BE REPRODUCED, COPIED, OR USED IN ANY MANNER WITHOUT
PRIOR WRITTEN CONSENT OF STEWART CONNECTOR. THIS PRODUCT
MAY BE PROTECTED BY ONE OR MORE OF THE FOLLOWING US PATENTS:
5791942 6217391 6368159 6419526 6602097 687722
6964587 7048590 7086909 7568950 7686650
OTHER PATENTS MAY BE PENDING.

DRN BY: TRM DATE 6-27-05

APPD BY: DHG DATE 6-27-05

DWG NO. CT730057 REV. C2



B

B

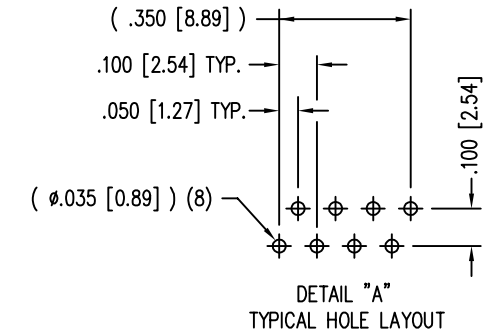
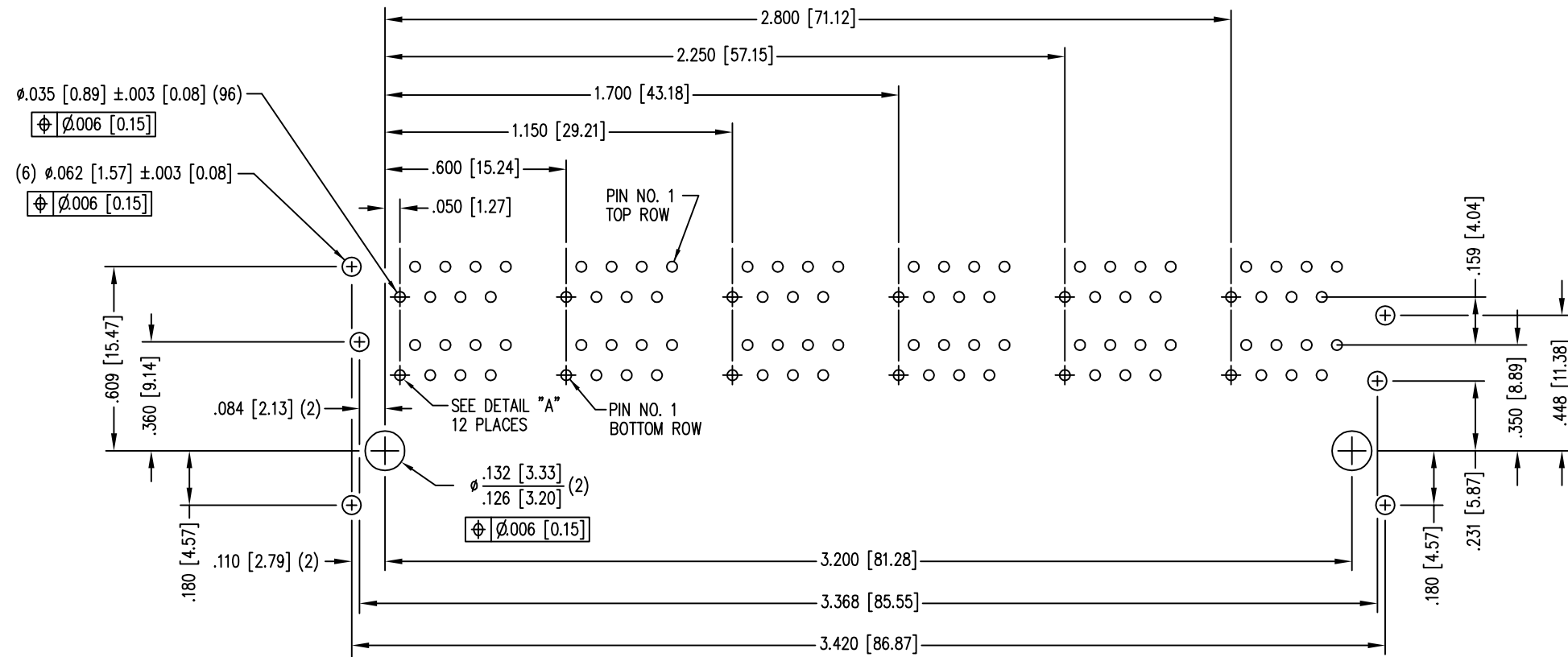

P.C.B. RECOMMENDED HOLE LAYOUT
 SEEN FROM COMPONENT SIDE
 ALL CENTERLINE DIMENSIONS ARE BASIC.

A

A

REV. 6/3/05



THIRD ANGLE PROJECTION 	 11118 Susquehanna Trail South Glen Rock, PA 17327-9199 (717) 235-7512 http://www.stewartconnector.com
DO NOT SCALE DRAWING DRAWING IS SUBJECT TO CHANGE WITHOUT NOTICE	TITLE: EIGHT CONTACT, EIGHT POSITION SHIELDED STACK JACK ENHANCED SHIELD, 12 PORT (6 ON 6)
DIMENSIONS: INCHES [METRIC]	THIS DRAWING AND THE SUBJECT MATTER SHOWN THEREON ARE CONFIDENTIAL AND THE PROPRIETARY PROPERTY OF STEWART CONNECTOR AND SHALL NOT BE REPRODUCED, COPIED, OR USED IN ANY MANNER WITHOUT PRIOR WRITTEN CONSENT OF STEWART CONNECTOR. THIS PRODUCT MAY BE PROTECTED BY ONE OR MORE OF THE FOLLOWING US PATENTS: 5791942 6217391 6368159 6419526 6602097 687722 6964587 7048590 7086909 7568950 7686650 OTHER PATENTS MAY BE PENDING.
SHEET NO. 2 OF 2	DRN BY: TRM DATE 6-27-05 APPD BY: DHG DATE 6-27-05 DWG NO. CT730057 REV. C2