



Chipsmall Limited consists of a professional team with an average of over 10 year of expertise in the distribution of electronic components. Based in Hongkong, we have already established firm and mutual-benefit business relationships with customers from,Europe,America and south Asia,supplying obsolete and hard-to-find components to meet their specific needs.

With the principle of “Quality Parts,Customers Priority,Honest Operation,and Considerate Service”,our business mainly focus on the distribution of electronic components. Line cards we deal with include Microchip,ALPS,ROHM,Xilinx,Pulse,ON,Everlight and Freescale. Main products comprise IC,Modules,Potentiometer,IC Socket,Relay,Connector.Our parts cover such applications as commercial,industrial, and automotives areas.

We are looking forward to setting up business relationship with you and hope to provide you with the best service and solution. Let us make a better world for our industry!



Contact us

Tel: +86-755-8981 8866 Fax: +86-755-8427 6832

Email & Skype: info@chipsmall.com Web: www.chipsmall.com

Address: A1208, Overseas Decoration Building, #122 Zhenhua RD., Futian, Shenzhen, China



DATE	REV	ECN	APP'D. BY
7-30-07	A0	-	-
9-26-07	B0	8242	TRM
2-22-08	B1	8366	TRM

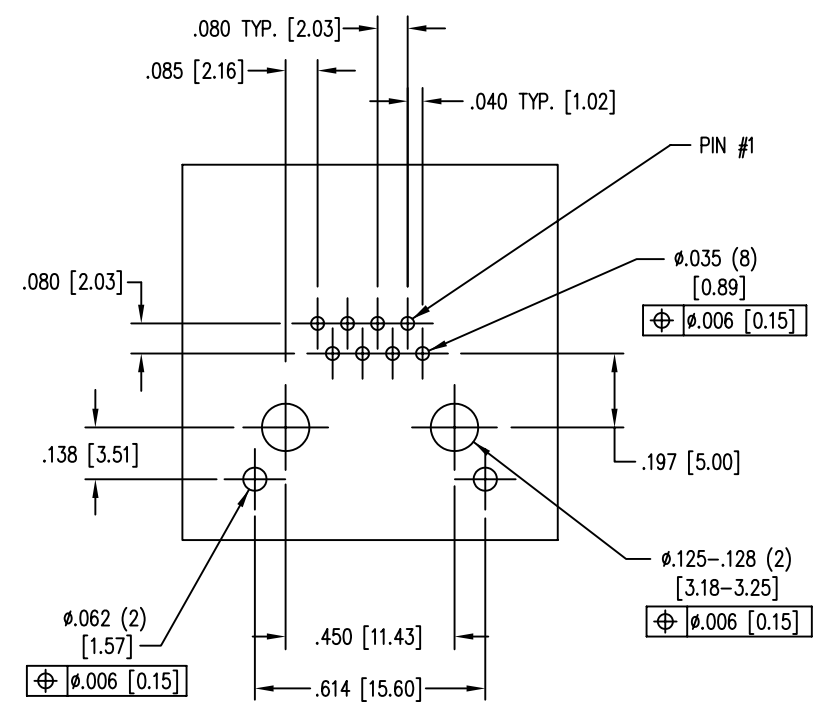
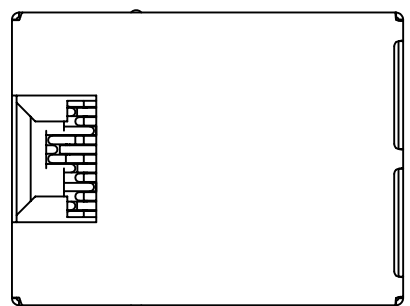

RECOMMENDED PCB HOLE LAYOUT
SEEN FROM COMPONENT SIDE
ALL CENTERLINE DIMENSIONS ARE BASIC

- NOTES:
- CONNECTOR MATERIALS:
HOUSING: THERMOPLASTIC UL94 V-0
CONTACT/SHIELD: COPPER ALLOY
SHIELD PLATING: "REFLOW" TIN
CONTACT PLATING: SELECTIVE GOLD IN CONTACT AREA
SEE CHART FOR PART NUMBER
 - PRODUCT DESIGNED FOR CAT6 APPLICATIONS.
 - DIMENSIONS AND TOLERANCES COMPLY WITH FCC/CFR 47, PART 68.
 - FOR PRODUCT SPECIFICATION SEE PR030-01.

B

B

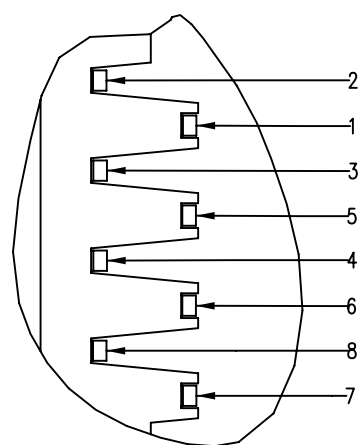
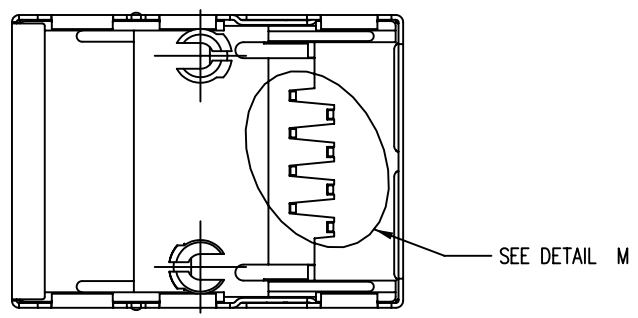
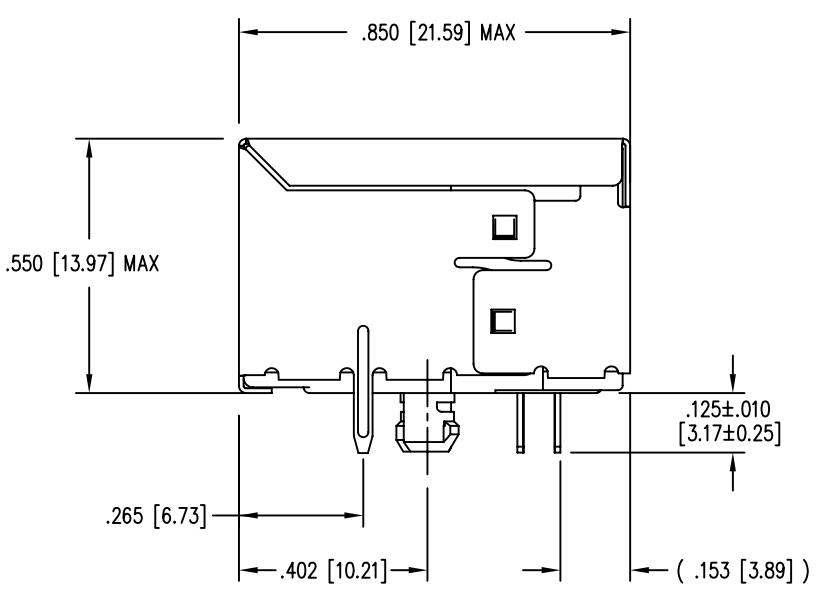
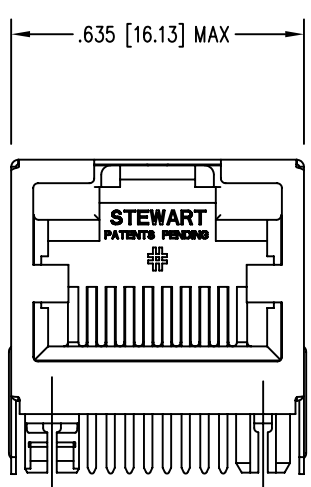

DETAIL M
OUTPUT PIN DESIGNATIONS

EPP-918A TYPICAL PROPERTIES		
PROPERTY	VALUE	TEST METHOD
COLOR	LIGHT YELLOW	
SPECIFIC GRAVITY	0.75	ASTM D-792
DENSITY	0.89	ASTM D-1480
OPERATING TEMPERATURE RANGE	-40°C TO 85°C	
WATER SOLUBILITY	NEGLECTIBLE	

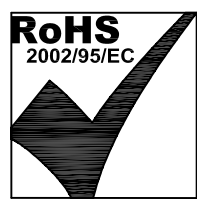

50 MICRO-INCHES [1.27um]	SS60000-009G
CONTACT PLATING IN MATING AREA	PART NUMBER

THIRD ANGLE PROJECTION

DO NOT SCALE DRAWING
DRAWING IS SUBJECT TO
CHANGE WITHOUT NOTICE

DIMENSIONS: INCHES [METRIC]

UNLESS OTHERWISE SPECIFIED
TOLERANCES ARE ±.005 [0.13]
ANGLES ARE ± 1°

SHEET NO. 1 OF 1

Bel Stewart Connector

11118 Susquehanna Trail South
Glen Rock, PA 17327-9199
(717) 235-7512 Fax: (717) 235-7954 <http://www.stewartconnector.com>

TITLE:
60 SERIES SHIELDED RIGHT ANGLE JACK, CONTAINS EPP-918A

THIS DRAWING AND THE SUBJECT MATTER SHOWN THEREON ARE CONFIDENTIAL AND THE PROPRIETARY PROPERTY OF BEL STEWART CONNECTOR AND SHALL NOT BE REPRODUCED, COPIED, OR USED IN ANY MANNER WITHOUT PRIOR WRITTEN CONSENT OF BEL STEWART CONNECTOR. THE SUBJECT MATTER MAY BE PATENTED OR A PATENT MAY BE PENDING.

DRN BY: TS	DATE 7-30-07
APPD BY: TRM	DATE 7-30-07
DWG NO. CT600024G	REV. B1

A

A

REV. 6/3/05