



Chipsmall Limited consists of a professional team with an average of over 10 year of expertise in the distribution of electronic components. Based in Hongkong, we have already established firm and mutual-benefit business relationships with customers from,Europe,America and south Asia,supplying obsolete and hard-to-find components to meet their specific needs.

With the principle of “Quality Parts,Customers Priority,Honest Operation,and Considerate Service”,our business mainly focus on the distribution of electronic components. Line cards we deal with include Microchip,ALPS,ROHM,Xilinx,Pulse,ON,Everlight and Freescale. Main products comprise IC,Modules,Potentiometer,IC Socket,Relay,Connector.Our parts cover such applications as commercial,industrial, and automotives areas.

We are looking forward to setting up business relationship with you and hope to provide you with the best service and solution. Let us make a better world for our industry!



## Contact us

Tel: +86-755-8981 8866 Fax: +86-755-8427 6832

Email & Skype: info@chipsmall.com Web: www.chipsmall.com

Address: A1208, Overseas Decoration Building, #122 Zhenhua RD., Futian, Shenzhen, China



DATE	REV	ECN	APP'D. BY
2-17-06	A1	-	-
1-18-07	A2	7902	TRM
6-15-07	A3	8103	TRM

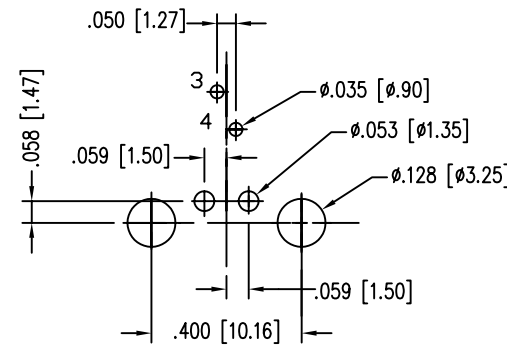
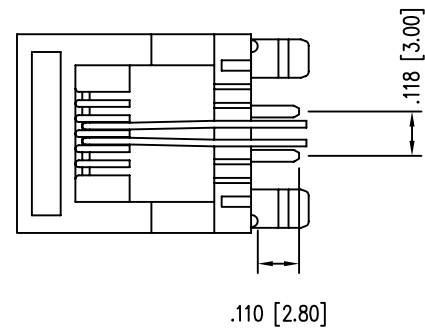
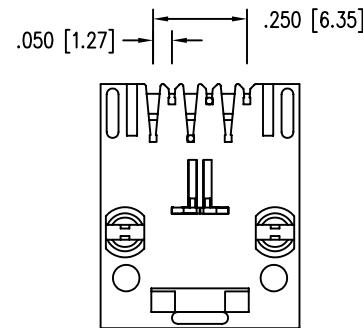
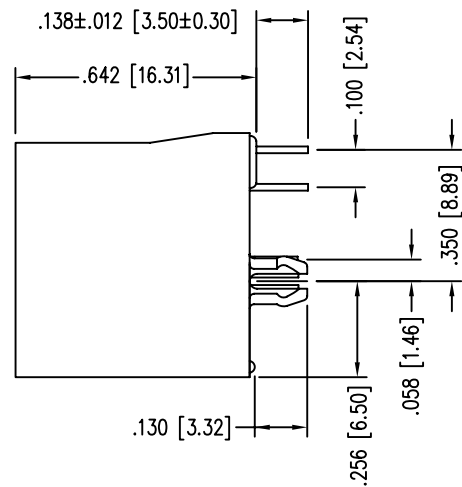
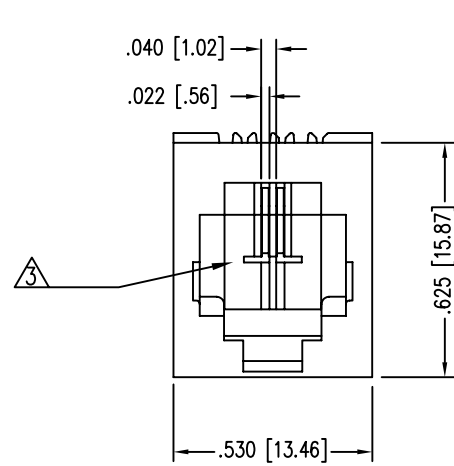

PC Board layout  
Component Side Shown

NOTES:

- CONNECTOR MATERIALS:  
HOUSING: THERMOPLASTIC UL94 V-0  
CONTACTS/SHIELD: COPPER ALLOY  
SHIELD PLATING: NICKEL OR "REFLOW" TIN  
CONTACT PLATING: SELECTIVE GOLD IN CONTACT AREA  
SEE CHART FOR PART NUMBER
- FOR PRODUCT SPECIFICATIONS SEE PRO27-01.
- DIMENSIONS AND TOLERANCES COMPLY WITH FCC/CFR 47, PART 68.

50 MICRO-INCHES [1.27um]	SS65600-010G
CONTACT PLATING IN MATING AREA	PART NUMBER

EPP-918 TYPICAL PROPERTIES		
PROPERTY	VALUE	TEST METHOD
COLOR	LIGHT YELLOW	
SPECIFIC GRAVITY	0.75	ASTM D-792
DENSITY	0.89	ASTM D-1480
OPERATING TEMPERATURE RANGE	-40°C TO 85°C	
WATER SOLUBILITY	NEGLECTIBLE	

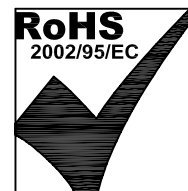

THIRD ANGLE PROJECTION

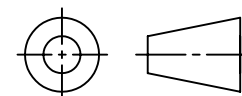

DO NOT SCALE DRAWING  
DRAWING IS SUBJECT TO  
CHANGE WITHOUT NOTICE

DIMENSIONS: INCHES [METRIC]

UNLESS OTHERWISE SPECIFIED  
TOLERANCES ARE ±.005 [0.13]  
ANGLES ARE ± 1°

SHEET NO. 1 OF 1

# Bel Stewart Connector

11118 Susquehanna Trail South  
Glen Rock, PA 17327-9199  
(717) 235-7512 Fax: (717) 235-7954 <http://www.stewartconnector.com>

TITLE: VERTICAL SHORTING JACK, TWO CONTACT, SIX POSITION,  
CONTAINS EPP-918

THIS DRAWING AND THE SUBJECT MATTER SHOWN THEREON  
ARE CONFIDENTIAL AND THE PROPRIETARY PROPERTY OF  
BEL STEWART CONNECTOR AND SHALL NOT BE REPRODUCED,  
COPIED, OR USED IN ANY MANNER WITHOUT PRIOR WRITTEN  
CONSENT OF BEL STEWART CONNECTOR. THE SUBJECT  
MATTER MAY BE PATENTED OR A PATENT MAY BE PENDING.

DRN BY:	RVO	DATE	02-02-05
APPD BY:	RCG	DATE	02-02-05
DWG NO.	CT650124G	REV.	A3