



Chipsmall Limited consists of a professional team with an average of over 10 year of expertise in the distribution of electronic components. Based in Hongkong, we have already established firm and mutual-benefit business relationships with customers from,Europe,America and south Asia,supplying obsolete and hard-to-find components to meet their specific needs.

With the principle of “Quality Parts,Customers Priority,Honest Operation,and Considerate Service”,our business mainly focus on the distribution of electronic components. Line cards we deal with include Microchip,ALPS,ROHM,Xilinx,Pulse,ON,Everlight and Freescale. Main products comprise IC,Modules,Potentiometer,IC Socket,Relay,Connector.Our parts cover such applications as commercial,industrial, and automotives areas.

We are looking forward to setting up business relationship with you and hope to provide you with the best service and solution. Let us make a better world for our industry!



## Contact us

Tel: +86-755-8981 8866 Fax: +86-755-8427 6832

Email & Skype: info@chipsmall.com Web: www.chipsmall.com

Address: A1208, Overseas Decoration Building, #122 Zhenhua RD., Futian, Shenzhen, China





**MODEL:** ST-025BH  
**PRODUCT:** Electromagnetic Buzzer  
**EDITION:** A/2017

**THIS SPECIFICATION APPLIES TO THE ELECTROMAGNETIC BUZZER**

**SPECIFICATION**

TEST CONDITION: TEMP= +25 ±2°C RELATED HUMIDITY= 65 ±5% AIR PRESSURE: 860 ~ 1060MBAR

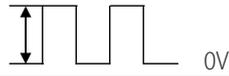
item	unit	specification	condition
rated voltage	Vo-p	3.6	Vo-p 
operating volt	Vo-p	2.5 ~ 4.5	
mean current	mA	Max.100	At rated voltage, square wave, 1/2 duty
coil resistance	Ω	16 ±3	
sound output	dBA	85	At 10cm (A-weight free air), at rated voltage 2700Hz, square wave, 1/2duty
rated frequency	Hz	2700	
operating temp	°C	-30 ~ +85	
storage temp	°C	-40 ~ +85	
dimension	mm	7.5×7.5×H2.5	See attached drawing
weight	gram	0.8	
material		LCP(Black)	
terminal		SMD Type (Plating Sn)	See attached drawing
environmental protection regulation		RoHS	

**ENVIRONMENT TEST**

item	test condition	evaluation standard
high temp. test	After being placed in a chamber at +85°C for 96 hours.	After the test the part will meet specifications without any degradation in appearance and performance except SPL. After 4 hours at +25°C.
low temp. test	After being placed in a chamber at -30°C for 96 hours.	The SPL will be in ±10dBA compared with initial one.
thermal shock	The part will be subjected to 10 cycles. One cycle shall consist of:	

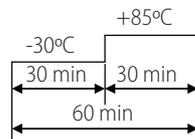

temp./humidity cycle The part will be subjected to 10 cycles. One cycle shall be 24 hours and consist of:

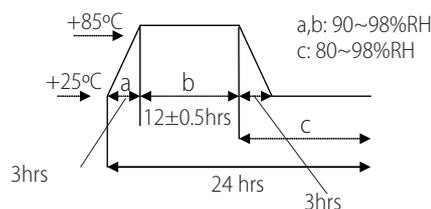



**MODEL:** ST-025BH  
**PRODUCT:** Electromagnetic Buzzer  
**EDITION:** A/2017

## RELIABILITY TEST

item	test conditions	evaluation standard
operating life test	ORDINARY TEMPERATURE The part will be subjected to 96 hours of continuous operation at +25 ±10°C.	After the test the part will meet specifications without any degradation in appearance and performance except SPL, after 4 hours at +25°C. Allowable variation of SPL after test: ±10dB
	HIGH TEMPERATURE The part will be subjected to 72 hours of continuous operation at +85°C with 3.6V, 2700Hz applied.	
	LOW TEMPERATURE The part will be subjected to 72 hours of continuous operation at -30°C with 3.6V, 2700Hz applied.	

### TEST CONDITION

Standard Test Condition: a) Temperature : +5 ~ +35°C    b) Humidity : 45 ~ 85%    c) Pressure : 860 ~ 1060mbar

## MECHANICAL CHARACTERISTICS

item	test conditions	evaluation standard
solderability	Lead terminal are immersed in rosin for 5 seconds and then immersed in solder bath of +260 ±5°C for 3 ±0.5 seconds	90% min. lead terminals will be wet with solder
soldering heat resistance	The product followed the reflow temperature curve to test its reflow thermostability.	No interference in operation.
terminal mechanical strength	Lead pads will be soldered on the pc board, and the force 9.8N(1.0Kg) will be applied behind the part for 10 seconds.	No damage and cutting off.
vibration	The part will be subjected to a vibration cycle of 10Hz to 55Hz to 10Hz in a period of 1 minute. Total peak amplitude will be 1.52mm(9.3G). The vibration test will consist of 2 hours per axis in each three axes(X,Y,Z). Total 6 hours.	After the test the part will meet specifications without any damage in appearance and performance except SPL. The SPL would be ±10dBA compared with the initial one.
drop test	The part only will be dropped from a height of 75cm onto a 40mm thick wooden board 3 times in 3 axes(X,Y,Z). A total of 9 times.	

## RECOMMENDED WAVE SOLDERING TEMPERATURE CURVE

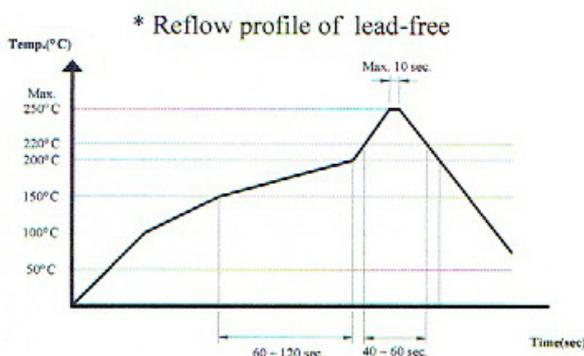

Recommendable reflow soldering condition as follows:

Note 1: It is requested that reflow soldering should be executed after heat of product goes down to normal temperature.

Note 2: Peak reflow temperature of 250°C Max 10 sec. with a maximum duration of 40-60 sec. between 220°C and 250°C



**MODEL:** ST-025BH  
**PRODUCT:** Electromagnetic Buzzer  
**EDITION:** A/2017

**MEASUREMENT TEST CIRCUIT**

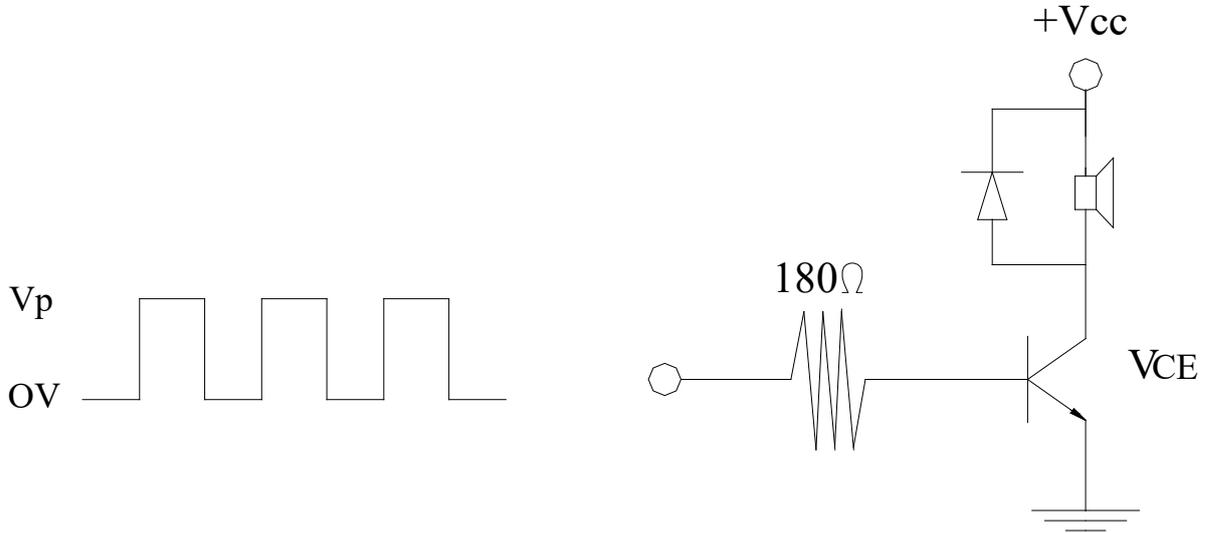

**INSPECTION FIXTURE**

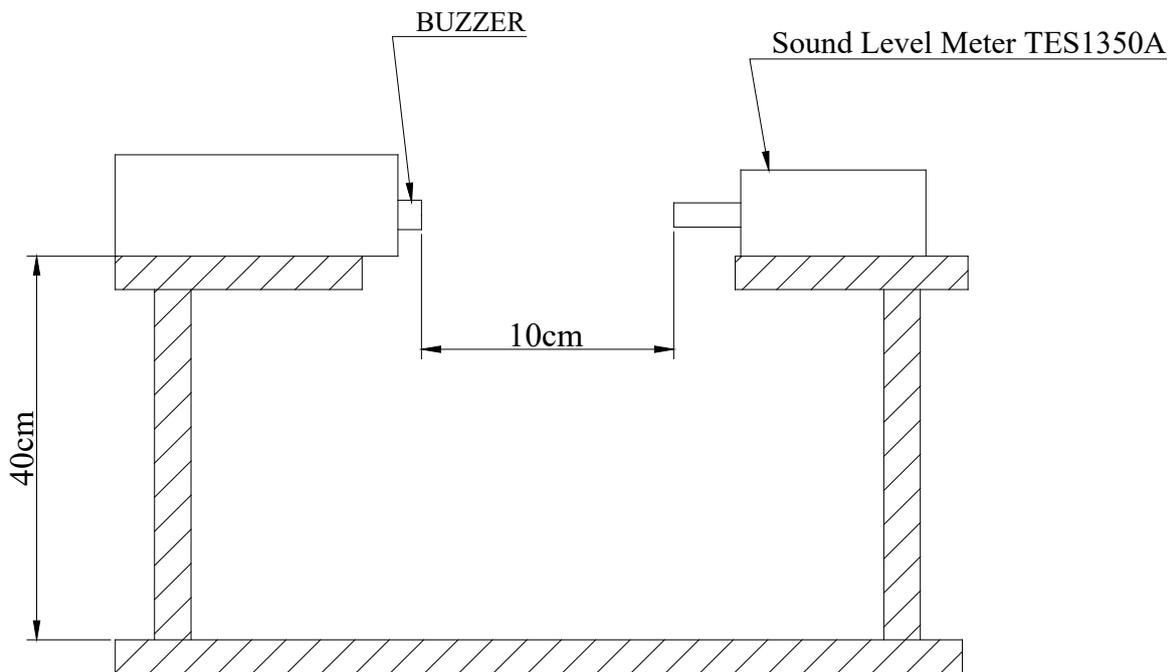



**MODEL:** ST-025BH  
**PRODUCT:** Electromagnetic Buzzer  
**EDITION:** A/2017

**DIMENSIONS**

Tolerance: ±0.3 (unit: mm)

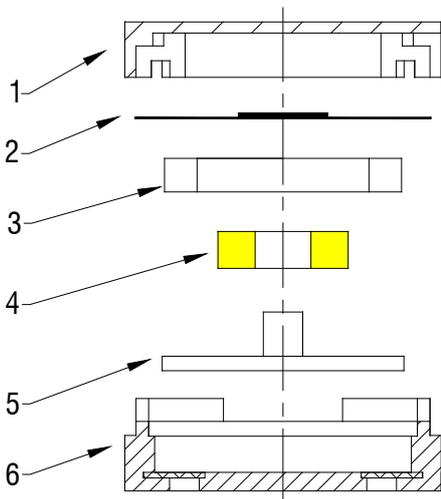
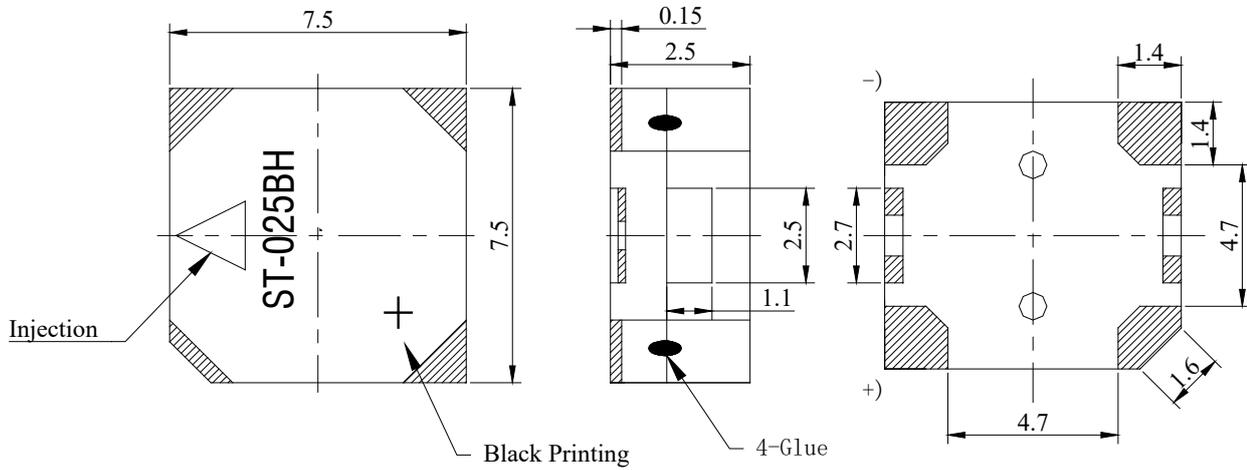

no	components	material	quantity
1	Case	LCP	1
2	Diaphragm	Ferrum	1
3	Magnet ring	NdFeB	1
4	Coil	Copper	1
5	Core	Ferrum	1
6	Case	LCP	1



**MODEL:** ST-025BH  
**PRODUCT:** Electromagnetic Buzzer  
**EDITION:** A/2017

**PACKING**

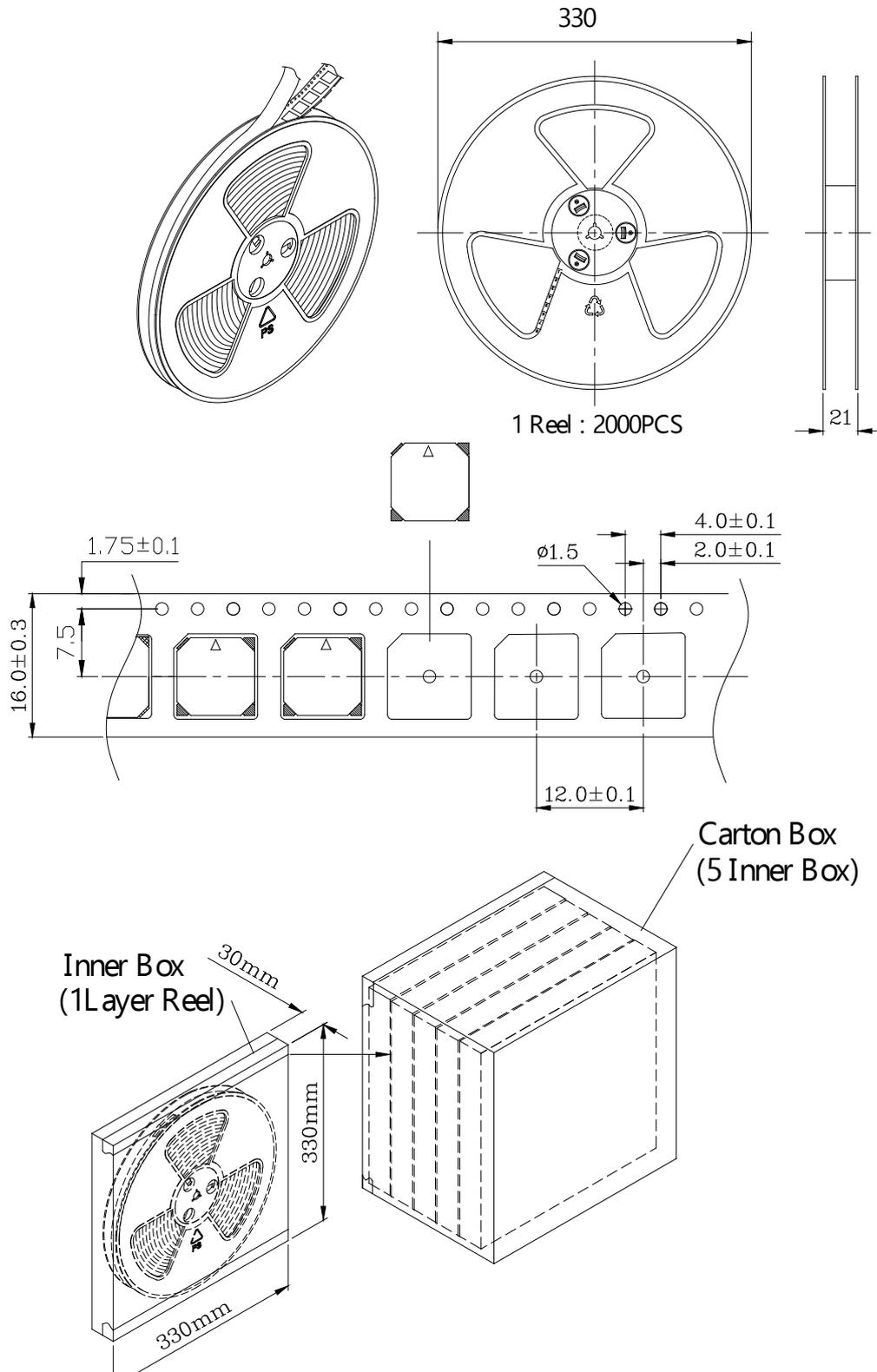

packing box	L x W x H (mm)	pieces
Inner Box	340x340x40	1 x 1000 = 2000pcs
Carton box	350 x 175 x 355	10 x 2000 = 20,000pcs