



Chipsmall Limited consists of a professional team with an average of over 10 year of expertise in the distribution of electronic components. Based in Hongkong, we have already established firm and mutual-benefit business relationships with customers from,Europe,America and south Asia,supplying obsolete and hard-to-find components to meet their specific needs.

With the principle of “Quality Parts,Customers Priority,Honest Operation,and Considerate Service”,our business mainly focus on the distribution of electronic components. Line cards we deal with include Microchip,ALPS,ROHM,Xilinx,Pulse,ON,Everlight and Freescale. Main products comprise IC,Modules,Potentiometer,IC Socket,Relay,Connector.Our parts cover such applications as commercial,industrial, and automotives areas.

We are looking forward to setting up business relationship with you and hope to provide you with the best service and solution. Let us make a better world for our industry!



Contact us

Tel: +86-755-8981 8866 Fax: +86-755-8427 6832

Email & Skype: info@chipsmall.com Web: www.chipsmall.com

Address: A1208, Overseas Decoration Building, #122 Zhenhua RD., Futian, Shenzhen, China



SPECIFICATION FOR APPROVAL

Customer :

Description : Magnetic Transducer

Soberton Part No. : ST-025BT

Date : 2008-12-18

Customer Model No. :

Date of Approval	
Authorization Signature	



211 N. First Street
Minneapolis, MN. 55401
612-849-6205

[Http://www.soberton.com](http://www.soberton.com) E-mail : info@soberton.com

Approved	Checked	Design
Ryan 2008/12/18	Wang Wei Rong 2008/12/18	Xu Hong Wei 2008/12/18

This specification applies magnetic buzzer, ST-025BT

B:SPECIFICATION

■ Test condition: TEMP=+25±2 °C Related humidity=45~60±5% Air pressure:860-1060mbar

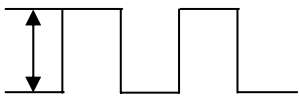
NO.	Item	Unit	Specification	Condition
1	Rated Voltage	Vo-p	3.6	
2	Operating Voltage	Vo-p	2.5 - 4.5	
3	Mean Current	mA	Max. 100	Applying rated voltage & rated frequency, square wave 1/2 duty
4	Coil Resistance	Ω	16 ± 3	
5	Sound Output	dBA	85/10cm	Distance at 10cm(A-weight free air), Applying rated voltage & rated frequency, square wave, 1/2 duty
6	Rated Frequency	Hz	3100	
7	Operating Temp	°C	-30-+85	
8	Storage Temp	°C	-40-+85	
9	Dimension	mm	7.5 × 7.5 × 2.5	See attached drawing.
10	Weight	gram	0.8	
11	Material		LCP (Black)	
12	Terminal		SMD type	See attached drawing
13	Environmental Protection Regulation		RoHS	
14	Storage life	month	3	3 months preservation at room temp(25±3°C), Humidity40%

C:ENVIRONMENT TEST

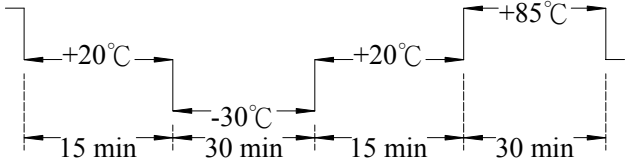
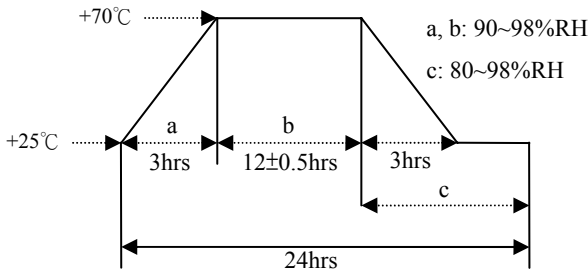
No.	Item	Test condition	Evaluation standard
1	High temp. test	After being placed in a chamber at +85°C for 96 hours.	After the test the part shall meet specifications without any degradation in appearance and performance except SPL. after 4 hours at +25°C, The SPL shall be in ± 10 dBA compared with initial one.
2	Low temp. test	After being placed in a chamber at -30°C for 96 hours.	
3	Thermal shock	The part shall be subjected to 10 cycles. One cycle shall consist of; 	
4	Temp. / Humidity Cycle	The part shall be subjected to 10 cycle and consist of; 	

D: RELIABILITY TEST

No.	Item	Test condition	Evaluation standard
1	Operating life test	<input type="checkbox"/> Applying rated voltage, rated frequency, square wave, 1/2 duty cycle : Ordinary temperature The part shall be subjected to 96 hours at room temperature.	After the test the part shall meet specifications without any degradation in appearance and performance except SPL. after 4 hours at +25°C, The SPL shall be in ± 10 dBA compared with initial one.

TEST CONDITION.

Standard Test Condition : a)Temperature: +5~+35°C b)Humidity:45~85% c)Pressure: 860~1060mbar

Judgment Test Condition :a)Temperature:+25±2°C b)Humidity:60~70% c)Pressure: 860~1060mbar

No	Item	Test condition	Evaluation standard
1	Solderability	Lead terminal are immersed in rosin for 5 seconds and then immersed in Solder bath of +260±5°C for 3±0.5 second	90% min. lead terminals shall be wet with solder
2	Soldering Heat Resistance	Lead terminal are immersed in soldering bath of +260±5°C for 3±0.5 Second.	
3	Iron Soldering Heat Resistance	Lead terminal are soldering of +350±5°C, 2.5±0.5 Second.	No interference in operation
4	Terminal Mechanical Strength	Apply the terminal with 9.8N(1kg) strength for 10±1 sec.	No damage and cutting off
5	Vibration	The part shall be subjected to a vibration cycle of 10Hz to 55Hz to 10Hz in a period of 1 minute. Total peak amplitude shall be 1.52mm(9.3G).The vibration test shall consist of 2 hours per axis in each three axes(X,Y,Z),Total 6 hours.	After the test the part shall meet specifications without any damage in appearance and performance except SPL. The SPL shall be in ± 10 dBA compared with initial one.
6	Drop test	The part only shall be dropped from a height of 75cm onto a wooden board 1 times.	

* Reflow profile of lead-free

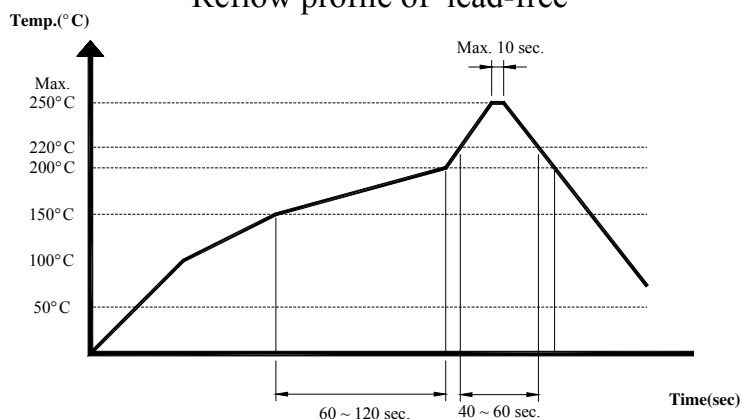

Recommendable reflow soldering condition is as follows.

Note 1: It is requested that reflow soldering should be executed after heat of product goes down to normal temperature.

Note 2: Peak reflow temperature of 250°C Max.10 sec., with a maximum duration of 40-60 sec. between 220°C and 250°C

F: MEASUREMENT METHOD

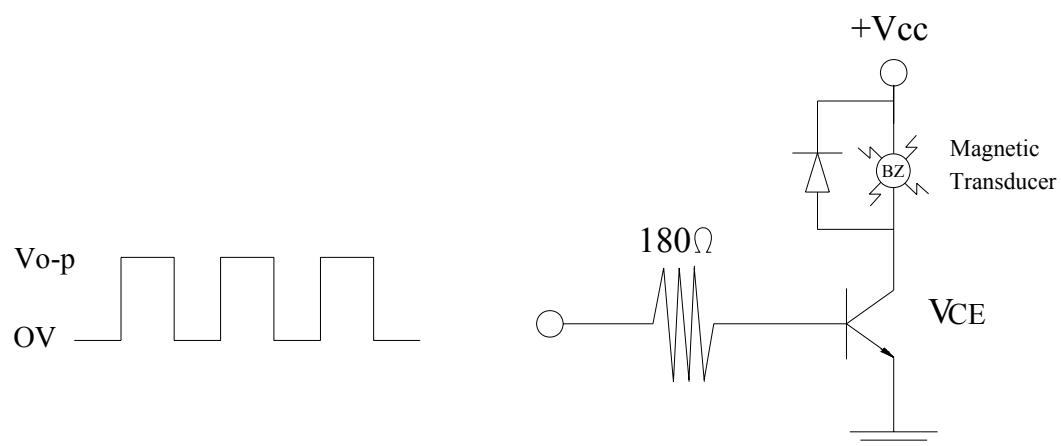

G: INSPECTION FIXTURE

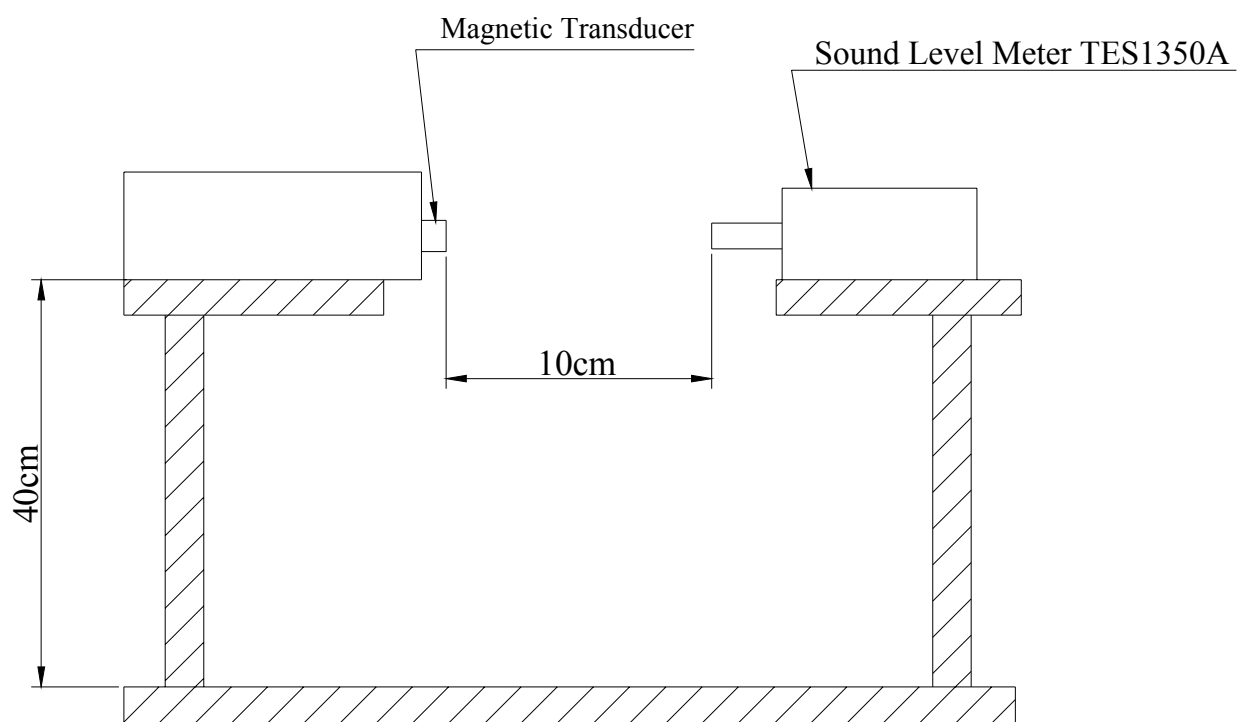

H: PACKING

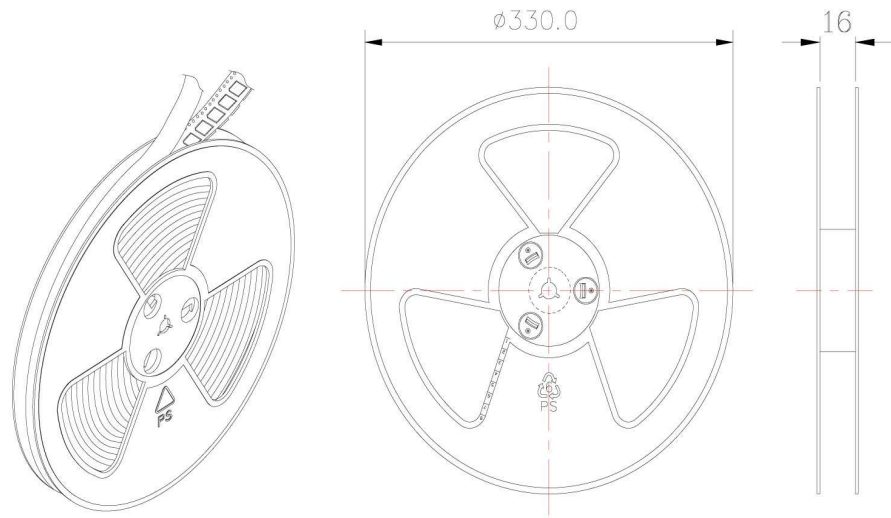

1 Reel : 2000PCS

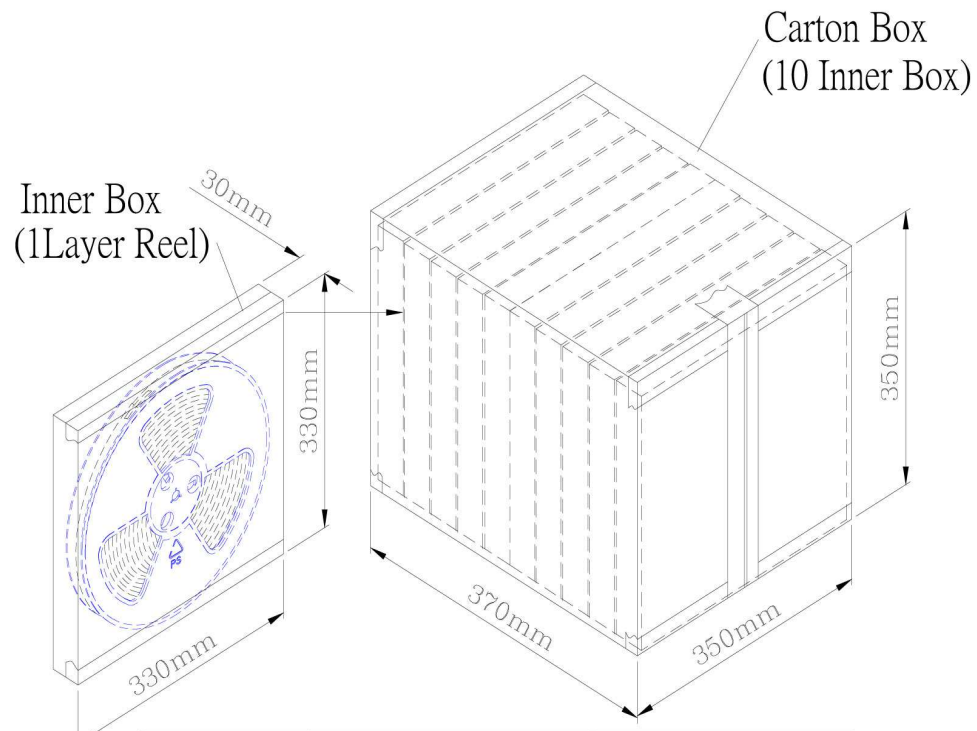
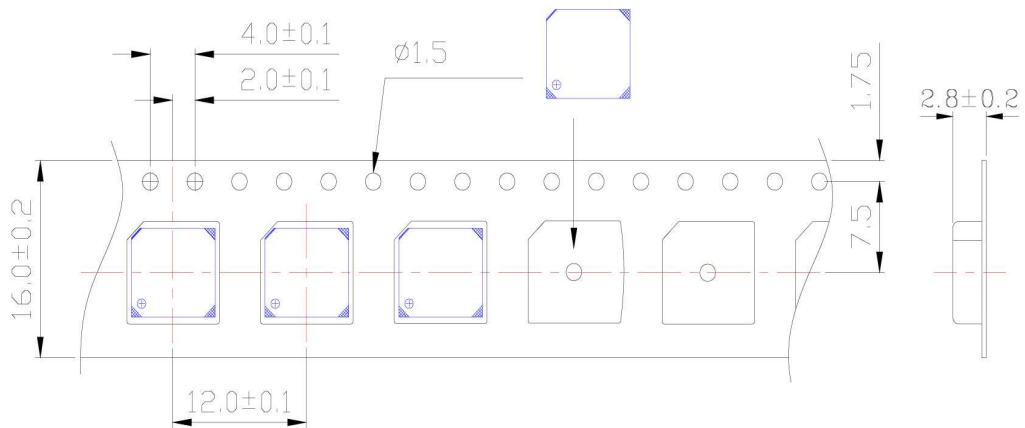

Inner Box	330mmx330mmx30mm	1x2000PCS=2000PCS
Carton Box	350mmx350mmx370mm	10x2000PCS=20,000PCS

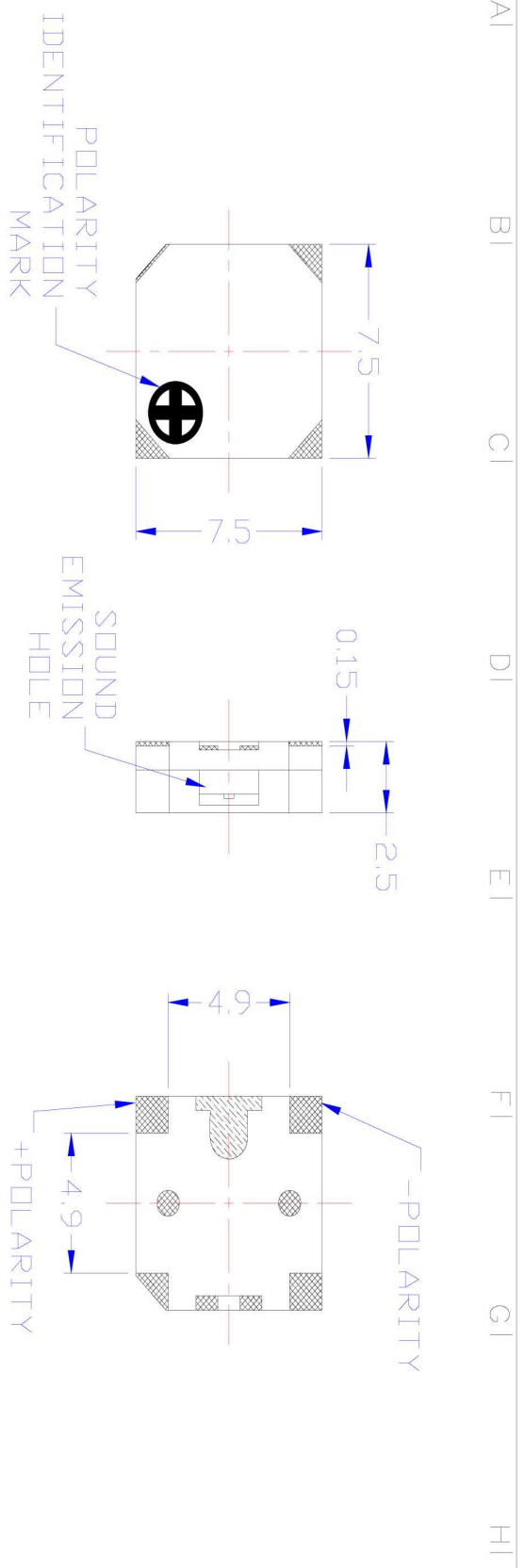

TOLERANCE : ± 0.30

Suggested Solder Pad Layout

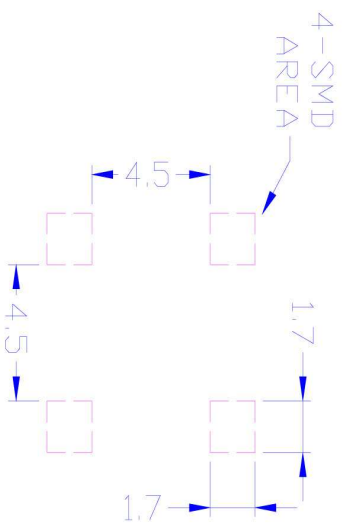

		DR.	SCALE	TITLE	MAGNETIC SOUND TRANSDUCER		
MODEL NO.	ST-025BT-1	CHK.	SHEET	MATERIAL	HOUSING : LCP	PART NO.	
		APP.	UNIT	FINISH			
			mm				

5	
4	
3	
2	
1	
NO	DATE
	ECN. NO.