



Chipsmall Limited consists of a professional team with an average of over 10 year of expertise in the distribution of electronic components. Based in Hongkong, we have already established firm and mutual-benefit business relationships with customers from,Europe,America and south Asia,supplying obsolete and hard-to-find components to meet their specific needs.

With the principle of "Quality Parts,Customers Priority,Honest Operation,and Considerate Service",our business mainly focus on the distribution of electronic components. Line cards we deal with include Microchip,ALPS,ROHM,Xilinx,Pulse,ON,Everlight and Freescale. Main products comprise IC,Modules,Potentiometer,IC Socket,Relay,Connector.Our parts cover such applications as commercial,industrial, and automotives areas.

We are looking forward to setting up business relationship with you and hope to provide you with the best service and solution. Let us make a better world for our industry!



Contact us

Tel: +86-755-8981 8866 Fax: +86-755-8427 6832

Email & Skype: info@chipsmall.com Web: www.chipsmall.com

Address: A1208, Overseas Decoration Building, #122 Zhenhua RD., Futian, Shenzhen, China





ST16C452 ST16C452PS

DUAL UART WITH PARALLEL PRINTER PORT

March 2004

DESCRIPTION

The ST16C452/ST16C452PS (452/452PS) is a dual universal asynchronous receiver and transmitter (UART) with an added bi-directional parallel port that is directly compatible with a CENTRONICS type printer. The parallel port is designed such that the user can configure it as general purpose I/O interface, or for connection to other printer devices. The 452/452PS provides enhanced UART functions, a modem control interface, and data rates up to 1.5Mbps. Onboard status registers provide the user with error indications and operational status. The system interrupts and control may be tailored to meet user requirements. An internal loop-back capability allows onboard diagnostics. A programmable baud rate generator is provided to select transmit and receive clock rates from 50 bps to 1.5 Mbps. The 452/452PS is available in a 68 pin PLCC package. The 452/452PS is compatible with the 16C450. The 452 is available in two versions, the ST16C452 and the ST16C452PS. The ST16C452 provides single hardware pin to control the printer port data direction while the 452PS provides an additionally software control bit to control the printer port data direction to become compatible PS/2 operating system. The 452/452PS is fabricated in an advanced CMOS process with low power consumption.

PLCC Package

FEATURES

Added features in devices with top mark date code of "F2 YYWW" and newer:

- 5V Tolerant Inputs
- Pin to pin and functional compatible to TL16C452
- 2.97 to 5.5 volt operation
- Software compatible with ST16C450, NS16C450
- 1.5 Mbps transmit/receive operation (24MHz)
- Independent transmit and receive control
- Modem and printer status registers
- UART port and printer port Bi-directional
- Printer port direction set by single control bit or 8 bit pattern (AA/55)
- Modem control signals (-CTS, -RTS, -DSR, -DTR, -RI, -CD)
- Programmable character lengths (5, 6, 7, 8)
- Even, odd, or no parity bit generation and detection
- Internal loop-back diagnostics
- TTL compatible inputs, outputs
- Low Power

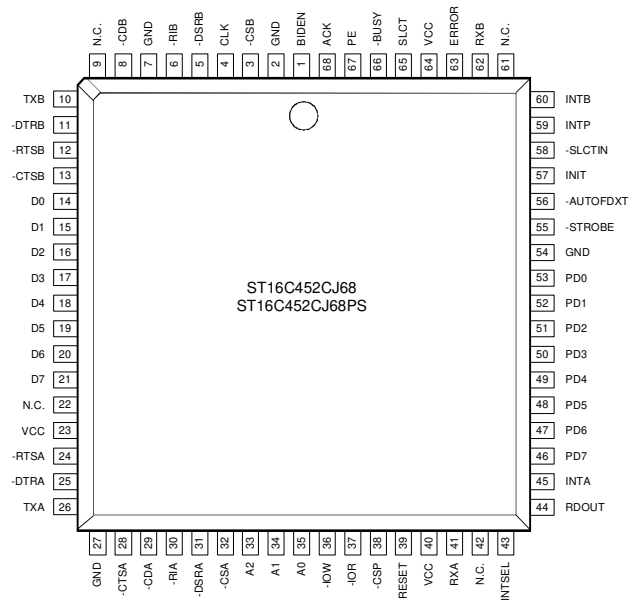

ORDERING INFORMATION

| Part number | Package | Operating temperature | Device Status |
|----------------|--------------|-----------------------|---------------|
| ST16C452CJ68 | 68-Lead PLCC | 0° C to + 70° C | Active |
| ST16C452CJ68PS | 68-Lead PLCC | 0° C to + 70° C | Active |
| ST16C452IJ68 | 68-Lead PLCC | -40° C to + 85° C | Active |
| ST16C452IJ68PS | 68-Lead PLCC | -40° C to + 85° C | Active |

Rev. 3.20

Figure 1, Block Diagram

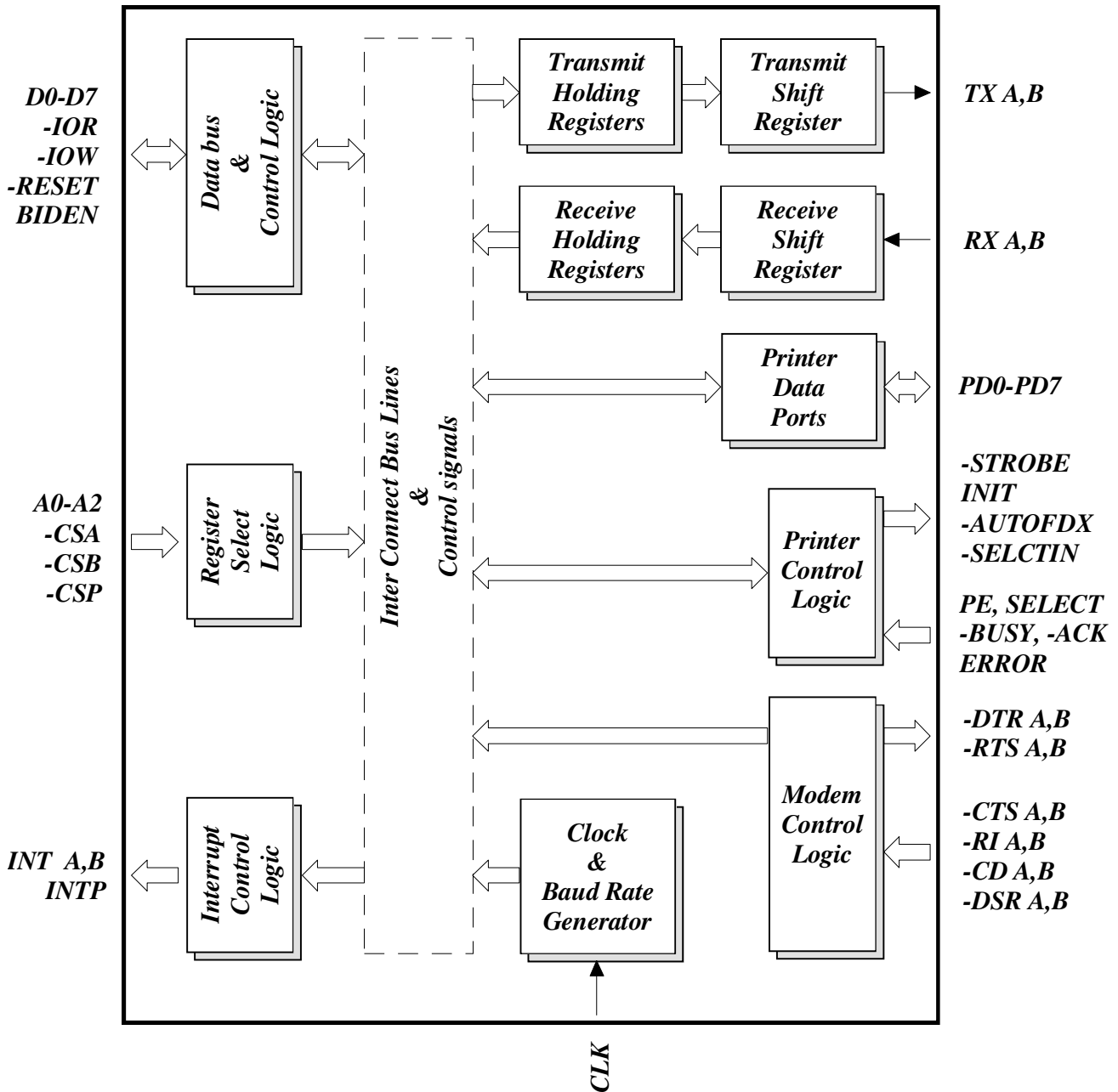

SYMBOL DESCRIPTION

| Symbol | Pin | Signal Type | Pin Description |
|-----------|-------|-------------|-------------------------------------------------------------------------------------------------------------------------------------------------------------------------------------------------------------------------------------------------|
| A0 | 35 | I | Address-0 Select Bit - Internal registers address selection. |
| A1 | 34 | I | Address-1 Select Bit - Internal registers address selection. |
| A2 | 33 | I | Address-2 Select Bit - Internal registers address selection. |
| -ACK | 68 | I | Acknowledge (with internal pull-up) - General purpose input or line printer acknowledge (active low). a logic 0 from the printer, indicates successful data transfer to the print buffer. |
| -AutoFDXT | 56 | I/O | General purpose I/O (open drain, with internal pull-up) or automatic line feed (open drain input with internal pull-up). When this signal is low the printer should automatically line feed after each line is printed. |
| BIDEN | 1 | I | Bi-Direction Enable - PD7-PD0 direction select. A logic 0 sets the parallel port for I/O Select Register Control. A logic 1 sets the parallel port for Control Register Bit-5 Control. |
| BUSY | 66 | I | Busy (with internal pull-up) - General purpose input or line printer busy (active high). can be used as an output from the printer to indicate printer is not ready to accept data. |
| CLK | 4 | I | Clock Input. - An external clock must be connected to this pin to clock the baud rate generator and internal circuitry (see Programmable Baud Rate Generator). |
| -CSA | 32 | I | Chip Select A - A logic 0 at this pin enables the serial channel-A UART registers for CPU data transfers. |
| -CSB | 3 | I | Chip Select B - A logic 0 at this pin enables the serial channel-B UART registers for CPU data transfers. |
| -CSP | 38 | I | Printer Port Chip Select - (active low). A logic 0 at this pin enables the parallel printer port registers and/or PD7-PD0 for external CPU data transfers. |
| D0-D7 | 14-21 | I/O | Data Bus (Bi-directional) - These pins are the eight bit, three state data bus for transferring information to or from the controlling CPU. D0 is the least significant bit and the first data bit in a transmit or receive serial data stream. |

SYMBOL DESCRIPTION

| Symbol | Pin | Signal Type | Pin Description |
|---------|--------------|-------------|-----------------------------------------------------------------------------------------------------------------------------------------------------------------------------------------------------------------------------------------------------------------------------------------------------------------------------------------------------------------------------------------------------------------------------------------------------------------------------------------------------------------------|
| -ERROR | 63 | I | Error, Printer (with internal pull-up) - General purpose input or line printer error. This pin may be connected to the active low (logic 0) output of a printer to indicate an error condition. |
| GND | 2,7,54 27 | Pwr | Signal and Power Ground. |
| INIT | 57 | I/O | Initialize (open drain, with internal pull-up) - General purpose I/O signal. This pin may be connected for initialization service of a connected line printer. Generally when this signal is a logic 0, any connected printer will be initialized. |
| INT A/B | 45,60 | O | Interrupt output A/B (three state active high) - These pins provide individual channel interrupts, INT A-B. INT A-B are enabled when MCR bit-3 is set to a logic 1, interrupts are enabled in the interrupt enable register (IER), and when an interrupt condition exists. Interrupt conditions include: receiver errors, available receiver buffer data, transmit buffer empty, or when a modem status flag is detected. |
| -INTP | 59 | O | Printer Interrupt, - This pin can be used to signal the interrupt status of a connected printer. This pin basically tracks the -ACK input pin, When INTSEL is a logic 0 and interrupts are enabled by bit-4 in the control register. A latched mode can be selected by setting INTSEL to a logic 1. In this case the interrupt -INTP is generated normally but does not return to the inactive state until the trailing edge of the read cycle (-IOR pin). -INTP is three stated until CON bit-4 is set to a logic 1. |
| INTSEL | 43 | I | Interrupt Select mode - This pin selects the interrupt type for the printer port (-INTP). When this pin is a logic 0, the external -ACK signal state is generally followed, minus some minor propagation delay. Making this pin a logic 1 or connecting it to VCC will set the interrupt latched mode. In this case the printer interrupt (-INTP) will not return to a logic 1 until the trailing edge of -IOR (end of the external CPU read cycle). |
| -IOR | 37 | I | Read strobe.- A logic 0 transition on this pin will place the contents of an Internal register defined by address bits A0-A2 |

SYMBOL DESCRIPTION

| Symbol | Pin | Signal Type | Pin Description |
|---------|-------|-------------|--------------------------------------------------------------------------------------------------------------------------------------------------------------------------------------------------------------------------------------------------------------------------------------------------------------------------------------------------------------------------------------------------------|
| -IOW | 36 | I | for either UART channels A/B or A0-A1 for the printer port, onto D0-D7 data bus for a read cycle by an external CPU. Write strobe.- A logic 0 transition on this pin will transfer the data on the internal data bus (D0-D7), as defined by either address bits A0-A2 for UART channels A/B or A0-A1 for the printer port, into an internal register during a write cycle from an external CPU. |
| PD7-PD0 | 46-53 | I/O | Printer Data port (Bi-directional three state) - These pins are the eight bit, three state data bus for transferring information to or from an external device (usually a printer). D0 is the least significant bit. PD7-PD0 are latched during a write cycle (output mode). |
| PE | 67 | I | Paper Empty - General purpose input or line printer paper empty (Internal pull-up). This pin can be connected to provide a printer out of paper indication. |
| RDOUT | 44 | O | Read Out (active high) - This pin goes to a logic 1 when the external CPU is reading data from the 452/452PS. This signal can be used to enable/disable external transceivers or other logic functions. |
| -RESET | 39 | I | Master Reset (active low) - a logic 0 on this pin will reset the internal registers and all the outputs. The UART transmitter output and the receiver input will be disabled during reset time. (See ST16C452/452PS External Reset Conditions for initialization details.) |
| N.C. | 9,61 | | Not Used. Should be left open. |
| SLCT | 65 | I | Select (with internal pull-up) - General purpose input or line printer select status. Normally this pin is connected to a printer output (active low) that indicates the ready status of a printer, i.e., on-line and/or on-line and ready. |
| -SLCTIN | 58 | I/O | Select In (open drain, with internal pull-up) - General purpose I/O or line printer select. This pin can be read via Bit-3 in the printer command register, or written via bit-3 in the printer control register. As this pin is open-drain, it can be wire-or'd with other outputs. Normally this signal is connected |

SYMBOL DESCRIPTION

| Symbol | Pin | Signal Type | Pin Description |
|----------|----------|-------------|-------------------------------------------------------------------------------------------------------------------------------------------------------------------------------------------------------------------------------------------------------------------------------------------------------------------------------------------------------------------------------------------------------------------------------------------------------------------------------------------------------------------------|
| -STROBE | 55 | I/O | with a printer to select the printer with an active low. Strobe (open drain, with internal pull-up) - General purpose I/O or data strobe output. Normally this output is connected to a printer and indicates that valid data is available at the printer port (PD0-PD7). |
| N.C. | 22,42 | | Not Used. Should be left open. |
| VCC | 23,40,64 | Pwr | 2.97 to 5.5V power supply input. All inputs are 5V tolerant except for XTAL1 and all printer port inputs for devices with top mark date code of "F2 YYWW" and newer. |
| -CD A/B | 29,8 | I | Carrier Detect (active low) - These inputs are associated with individual UART channels A through B. A logic 0 on this pin indicates that a carrier has been detected by the modem for that channel. |
| -CTS A/B | 28,13 | I | Clear to Send (active low) - These inputs are associated with individual UART channels, A through B. A logic 0 on this pin(s) indicates the modem or data set is ready to accept transmit data from the 452/452PS for the given channel. Status can be tested by reading MSR bit-4 for that channel(s). -CTS has no effect on the transmit or receive operation. |
| -DSR A/B | 31,5 | I | Data Set Ready (active low) - These inputs are associated with individual UART channels, A through B. A logic 0 on this pin(s) indicates the modem or data set is powered-on and is ready for data exchange with the UART. This pin has no effect on the UART's transmit or receive operation. |
| -DTR A/B | 25,11 | O | Data Terminal Ready (active low) - These outputs are associated with individual UART channels, A through B. A logic 0 on this pin(s) indicates that the 452/452PS is powered-on and ready. This pin can be controlled via the modem control register for channel(s) A-B. Writing a logic 1 to MCR bit-0 will set the -DTR output to logic 0, enabling the modem. This pin will be a logic 1 after writing a logic 0 to MCR bit-0, or after a reset. This pin has no effect on the UART's transmit or receive operation. |
| -RI A/B | 30,6 | I | Ring Indicator (active low) - These inputs are associated with |

SYMBOL DESCRIPTION

| Symbol | Pin | Signal Type | Pin Description |
|----------|-------|-------------|-----------------------------------------------------------------------------------------------------------------------------------------------------------------------------------------------------------------------------------------------------------------------------------------------------------------------------------------------------------------------------------------------------------------------------------------------------------------------------------------------------------------------------------------------------------------------------------------------------------------------------------------------------------------------------------------------------------------------------------------------------------------------------------------------------------------|
| -RTS A/B | 24,12 | O | <p>individual UART channels, A through B. A logic 0 on this pin(s) indicates the modem has received a ringing signal from the telephone line(s). A logic 1 transition on this input pin will generate an interrupt for the ringing channel(s). This pin does not have any effect on the transmit or receive operation.</p> <p>Request to Send (active low) - These outputs are associated with individual UART channels, A through B. A logic 0 on the -RTS pin(s) indicates the transmitter has data ready and waiting to send for the given channel(s). Writing a logic 1 in the modem control register (MCR bit-1) will set this pin to a logic 0 indicating data is available. After a reset this pin will be set to a logic 1. This pin does not have any effect on the transmit or receive operation.</p> |
| RX A/B | 41,62 | I | <p>Receive Data Input, RX A-B. - These inputs are associated with individual serial channel(s) to the 452. The RX signal will be a logic 1 during reset, idle (no data), or when the transmitter is disabled. During the local loop-back mode, the RX input pins are disabled and TX data is internally connected to the UART RX Inputs, internally.</p> |
| TX A/B | 26,10 | O | <p>Transmit Data, TX A-B - These outputs are associated with individual serial transmit channel(s) from the 452/452PS. The TX signal will be a logic 1 during reset, idle (no data), or when the transmitter is disabled. During the local loop-back mode, the TX output pins are disabled and TX data is internally connected to the UART RX Inputs.</p> |

GENERAL DESCRIPTION

The 452/452PS provides serial asynchronous receive data synchronization, parallel-to-serial and serial-to-parallel data conversions for both the transmitter and receiver sections. These functions are necessary for converting the serial data stream into parallel data that is required with digital data systems. Synchronization for the serial data stream is accomplished by adding start and stops bits to the transmit data to form a data character (character orientated protocol). Data integrity is insured by attaching a parity bit to the data character. The parity bit is checked by the receiver for any transmission bit errors. The electronic circuitry to provide all these functions is fairly complex especially when manufactured on a single integrated silicon chip. The 452/452PS represents such an integration with greatly enhanced features. The 452/452PS is fabricated with an advanced CMOS process.

The 452/452PS combines the package functions of a dual UART and a printer interface on a single integrated chip. The 452/452PS UART is indented to be software compatible with the ST16C450, and NS16C450 while the bi-directional printer interface mode is intended to operate with a CENTRONICS type parallel printer. However, the printer interface is designed such that it may be configured to operate with other parallel printer interfaces or used as a general purpose parallel interface. The 452 is available in two versions, the ST16C452 and the ST16C452PS. The ST16C452 provides single hardware pin to control the printer port data direction while the 452PS provides an additionally software control bit to control the printer port data direction to become compatible PS/2 operating system.

The 452/452PS is capable of operation to 1.5Mbps with a 24 MHz external clock input. With an external clock input of 1.8432 MHz the user can select data rates up to 115.2 Kbps.

FUNCTIONAL DESCRIPTIONS

Functional Modes

Two functional user modes are selectable for the 452/452PS package. The first of these provides the dual UART functions, while the other provides the functions of a parallel printer interface. These features are available through selection at the package interface select pins.

UART A-B Functions

The UART mode provides the user with the capability to transfer information between an external CPU and the 452/452PS package. A logic 0 on chip select pins -CSA or -CSB allows the user to configure, send data, and/or receive data via the UART channels A-B.

Printer Port Functions

The Printer mode provides the user with the capability to transfer information between an external CPU and the 452/452PS parallel printer port. A logic 0 on chip select pin -CSP allows the user to configure, send data, and/or receive data via the bi-directional parallel 8-bit data bus, PD0-PD7.

Internal Registers

The 452/452PS provides 11 internal registers for monitoring and control of the UART functions and another 6 registers for monitoring and controlling the printer port. These registers are shown in Table 4 below. The UART registers function as data holding registers (THR/RHR), interrupt status and control registers (IER/ISR), line status and control registers (LCR/LSR), modem status and control registers (MCR/MSR), programmable data rate (clock) control registers (DLL/DLM), and a user assessable scratchpad register (SPR). The printer port registers functions data holding registers (PR), I/O status register (SR), I/O select register (IOSEL), and a command and control register (COM/CON). Register functions are more fully described in the following paragraphs.

Table 4, INTERNAL REGISTER DECODE

| A2 | A1 | A0 | READMODE | WRITE MODE |
|--------------------------------------------------------------------------------|----|----|---------------------------|---------------------------|
| General Register Set (THR/RHR, IER/ISR, MCR/MSR, LCR/LSR, SPR): Note 1* | | | | |
| 0 | 0 | 0 | Receive Holding Register | Transmit Holding Register |
| 0 | 0 | 1 | | Interrupt Enable Register |
| 0 | 1 | 0 | Interrupt Status Register | |
| 0 | 1 | 1 | | Line Control Register |
| 1 | 0 | 0 | | Modem Control Register |
| 1 | 0 | 1 | Line Status Register | |
| 1 | 1 | 0 | Modem Status Register | |
| 1 | 1 | 1 | Scratchpad Register | Scratchpad Register |
| Baud Rate Register Set (DLL/DLM): Note *2 | | | | |
| 0 | 0 | 0 | LSB of Divisor Latch | LSB of Divisor Latch |
| 0 | 0 | 1 | MSB of Divisor Latch | MSB of Divisor Latch |
| Printer Port Set (PR/SR/IOSEL/COM/CON): Note *3 | | | | |
| X | 0 | 0 | PORT REGISTER | PORT REGISTER |
| X | 0 | 1 | STATUS REGISTER | I/O SELECT REGISTER |
| X | 1 | 0 | COMMAND REGISTER | CONTROL REGISTER |

Note 1* The General Register set is accessible only when CS A or CS B is a logic 0.

Note 2* The Baud Rate register set is accessible only when CS A or CS B is a logic 0 and LCR bit-7 is a logic 1.

Note 3*: Printer Port Register set is accessible only when -CSP is a logic 0 in conjunction with the states of the interface signal BIDEN and Printer Control Register bit-5 or IOSEL register.

Programmable Baud Rate Generator

The 452/452PS supports high speed modem technologies that have increased input data rates by employing data compression schemes. For example a 33.6Kbps modem that employs data compression may require a 115.2Kbps input data rate. A 128.0Kbps ISDN modem that supports data compression may need an input data rate of 460.8Kbps. The 452/452PS can support a standard data rate of 921.6Kbps.

Single baud rate generator is provided for the transmitter and receiver, allowing independent TX/RX channel control. The programmable Baud Rate Generator is capable of accepting an input clock up to 24 MHz, as required for supporting a 1.5Mbps data rate. The 452/452PS requires that an external clock source be connected to the CLK input pin to clock the internal baud rate generator for standard or custom rates. (see Baud Rate Generator Programming below).

The generator divides the input 16X clock by any divisor from 1 to $2^{16} - 1$. The 452/452PS divides the basic external clock by 16. The basic 16X clock provides table rates to support standard and custom applications using the same system design. The rate table is configured via the DLL and DLM internal register functions. Customized Baud Rates can be achieved by selecting the proper divisor values for the MSB and LSB

sections of baud rate generator.

Programming the Baud Rate Generator Registers DLM (MSB) and DLL (LSB) provides a user capability for selecting the desired final baud rate. The example in Table 5 below, shows the selectable baud rate table available when using a 1.8432 MHz external clock input.

Table 5, BAUD RATE GENERATOR PROGRAMMING TABLE (1.8432 MHz CLOCK):

| Output Baud Rate | Output 16 x Clock Divisor (Decimal) | User 16 x Clock Divisor (HEX) | DLM Program Value (HEX) | DLL Program Value (HEX) |
|------------------|-------------------------------------|-------------------------------|-------------------------|-------------------------|
| 50 | 2304 | 900 | 09 | 00 |
| 110 | 1047 | 417 | 04 | 17 |
| 150 | 768 | 300 | 03 | 00 |
| 300 | 384 | 180 | 01 | 80 |
| 600 | 192 | C0 | 00 | C0 |
| 1200 | 96 | 60 | 00 | 60 |
| 2400 | 48 | 30 | 00 | 30 |
| 4800 | 24 | 18 | 00 | 18 |
| 7200 | 16 | 10 | 00 | 10 |
| 9600 | 12 | 0C | 00 | 0C |
| 19.2k | 6 | 06 | 00 | 06 |
| 38.4k | 3 | 03 | 00 | 03 |
| 57.6k | 2 | 02 | 00 | 02 |
| 115.2k | 1 | 01 | 00 | 01 |

Loop-back Mode

The internal loop-back capability allows onboard diagnostics. In the loop-back mode the normal modem interface pins are disconnected and reconfigured for loop-back internally. MCR register bits 0-3 are used for controlling loop-back diagnostic testing. In the loop-back mode INT enable and MCR bit-2 in the MCR register (bits 2,3) control the modem -RI and -CD inputs respectively. MCR signals -DTR and -RTS (bits 0-1) are used to control the modem -CTS and -DSR inputs respectively. The transmitter output (TX) and

the receiver input (RX) are disconnected from their associated interface pins, and instead are connected together internally (See Figure 6). The -CTS, -DSR, -CD, and -RI are disconnected from their normal modem control inputs pins, and instead are connected internally to -DTR, -RTS, INT enable and MCR bit-2. Loop-back test data is entered into the transmit holding register via the user data bus interface, D0-D7. The transmit UART serializes the data and passes the serial data to the receive UART via the internal loop-back connection. The receive UART converts the serial data back into parallel data that is then made

available at the user data interface, D0-D7. The user optionally compares the received data to the initial transmitted data for verifying error free operation of the UART TX/RX circuits.

are fully operational. The Modem Control Interrupts are also operational. However, the interrupts can only be read using lower four bits of the Modem Control Register (MCR bits 0-3) instead of the four Modem Status Register bits 4-7. The interrupts are still controlled by the IER.

In this mode, the receiver and transmitter interrupts

Figure 6, INTERNAL LOOP-BACK MODE DIAGRAM

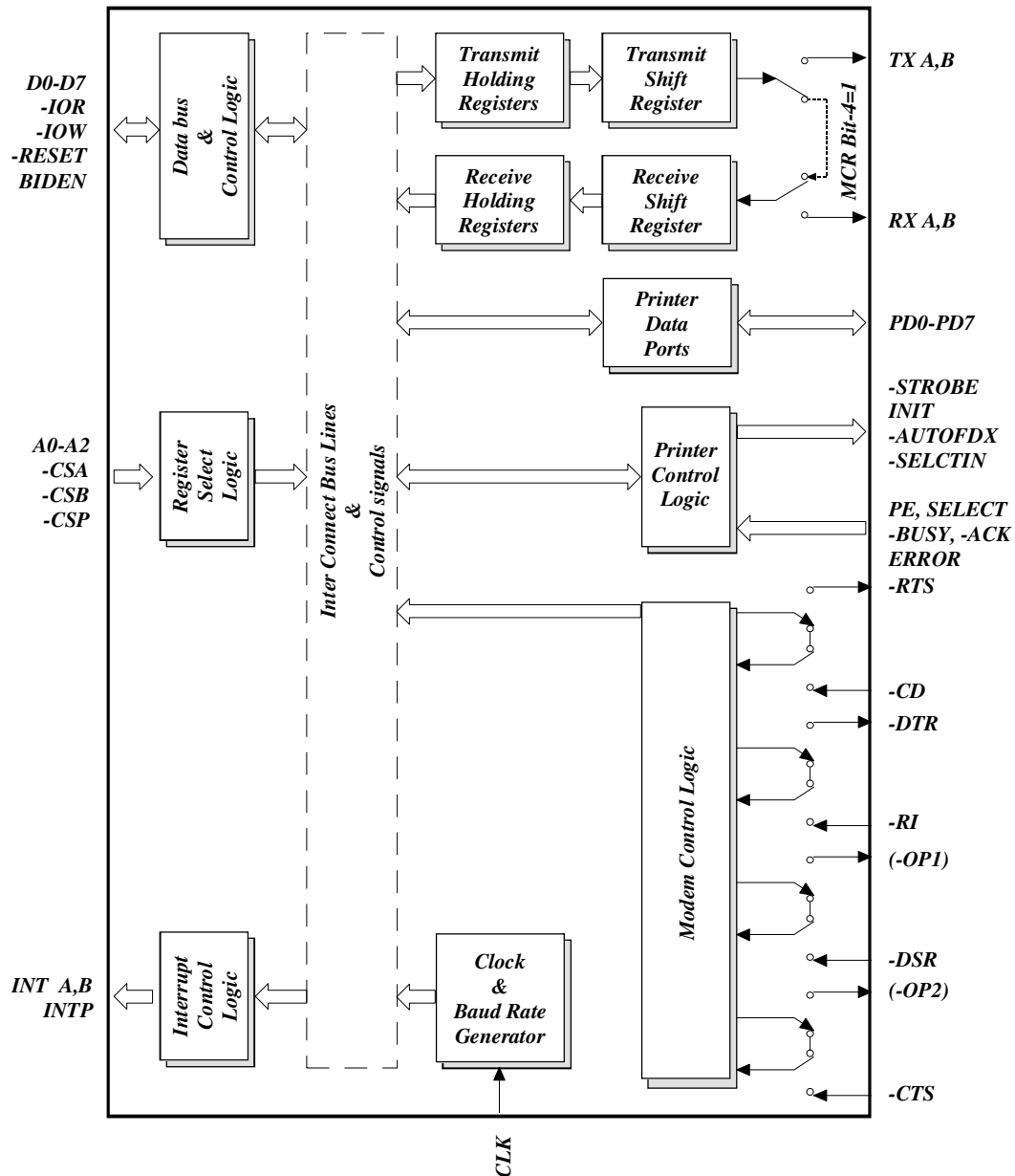

Printer Port

The 452/452PS contains a general purpose 8-bit parallel interface port that is designed to directly interface with a CENTRONICS Printer. A number of the control/interrupt signals and the 8-bit data bus have been designed as bi-directional data buses. This allows the interface to function with other device parallel data bus applications. Signal -ACK is used to generate an -INTP interface interrupt that would normally be connected to the user CPU. -INTP can be made to follow the -ACK signal, normal mode (see Figure 7) or it can be configured for the latch mode. In the latch mode the interrupt is not cleared until printer status register (SR) is read. Another signal (INIT) can be made to function as an outgoing or incoming interrupt, or combined with other interrupts to provide a common wire-or interrupt output. Interface signals -STROBE, -AutoFDXT, and -SLCTIN are bi-directional and can be used as combinations of input and/or output functions. The signals have internal pull-up resistors and can be wire-or'd. Normally, -STROBE is

used to strobe PD0-PD7 bus data into a printer input buffer. -SLCTIN normally selects the printer while AutoFDXT signals the printer to auto-linefeed. Other signals provide similar printer functions but are not bi-directional. The printer functions for these signals are described in table 1, Symbol Description.

The interface provides a mode steering signal called BIDEN. BIDEN controls the bi-directional 8-bit data bus (PD0-PD7) direction, input or output. This pin controls the port direction in the ST16C452. A logic 0 on this pin places the parallel port in the output mode and a logic 1 places the parallel port in the input mode. In the ST16C452PS, the port direction is determined as described in Table 6. When BIDEN is a logic 1 a single control bit (D5) in the control register sets the input or output mode. Setting BIDEN to a logic 0 however sets an IBM interface compatible mode. In this mode the bus direction (input/output) is set by eight data bits in the IOSEL register. An AA (Hex) pattern sets the input mode while a 55 (hex) pattern sets the output mode. I/O direction is depicted in Table 6 below.

Table 6, PD0-PD7 I/O DIRECTION MODE SELECTION [452PS only]

| PORT DIRECTION | BIDEN | CONTROL REGISTER (D5) | I/O SELECT REGISTER |
|----------------|-------|-----------------------|---------------------|
| Input mode | 0 | X (Note 4) | AA Hex |
| Output mode | 0 | X (Note 4) | 55 Hex |
| Output mode | 1 | 0 | X (Note 4) |
| Input mode | 1 | 1 | X (Note 4) |

Note: 4 = don't care

REGISTER FUNCTIONAL DESCRIPTIONS

The following table delineates the assigned bit functions for the eighteen 452/452PS internal registers. The assigned bit functions are more fully defined in the following paragraphs.

Table 7, ST16C452/452PS INTERNAL REGISTERS

| A2 | A1 | A0 | Register [Default] Note 5* | BIT-7 | BIT-6 | BIT-5 | BIT-4 | BIT-3 | BIT-2 | BIT-1 | BIT-0 |
|--------------------------------------|----|----|----------------------------------|----------------------------|-----------------------|---------------|--------------------|------------------------------|----------------------------------------|----------------------------------------------|--------------------------------|
| General Register Set: Note 1* | | | | | | | | | | | |
| 0 | 0 | 0 | RHR [XX] | bit-7 | bit-6 | bit-5 | bit-4 | bit-3 | bit-2 | bit-1 | bit-0 |
| 0 | 0 | 0 | THR [XX] | bit-7 | bit-6 | bit-5 | bit-4 | bit-3 | bit-2 | bit-1 | bit-0 |
| 0 | 0 | 1 | IER [00] | 0 | 0 | 0 | 0 | Modem Status Interrupt | Receive Line Status interrupt | Transmit Holding Register interrupt | Receive Holding Register |
| 0 | 1 | 0 | ISR [01] | 0 | 0 | 0 | 0 | INT priority bit-2 | INT priority bit-1 | INT priority bit-0 | INT status |
| 0 | 1 | 1 | LCR [00] | divisor latch enable | set break | set parity | even parity | parity enable | stop bits | word length bit-1 | word length bit-0 |
| 1 | 0 | 0 | MCR [00] | 0 | 0 | 0 | loop back | INT A/B enable | [X] | -RTS | -DTR |
| 1 | 0 | 1 | LSR [60] | 0 | THR & TSR empty | THR. empty | break interrupt | framing error | parity error | overrun error | receive data ready |
| 1 | 1 | 0 | MSR [X0] | CD | RI | DSR | CTS | delta -CD | delta -RI | delta -DSR | delta -CTS |
| 1 | 1 | 1 | SPR [FF] | bit-7 | bit-6 | bit-5 | bit-4 | bit-3 | bit-2 | bit-1 | bit-0 |
| Special Register Set: Note *2 | | | | | | | | | | | |
| 0 | 0 | 0 | DLL [XX] | bit-7 | bit-6 | bit-5 | bit-4 | bit-3 | bit-2 | bit-1 | bit-0 |
| 0 | 0 | 1 | DLM [XX] | bit-15 | bit-14 | bit-13 | bit-12 | bit-11 | bit-10 | bit-9 | bit-8 |

| A2 | A1 | A0 | Register [Default] Note 5* | BIT-7 | BIT-6 | BIT-5 | BIT-4 | BIT-3 | BIT-2 | BIT-1 | BIT-0 |
|-------------------------------------------|----|----|----------------------------------|--------------|--------------|------------------|-----------------|----------------|-------|---------------|--------------|
| Printer Port Register Set: Note 3* | | | | | | | | | | | |
| [X] | 0 | 0 | PR[00] | bit-7 | bit-6 | bit-5 | bit-4 | bit-3 | bit-2 | bit-1 | bit-0 |
| [X] | 0 | 0 | PR[00] | bit-7 | bit-6 | bit-5 | bit-4 | bit-3 | bit-2 | bit-1 | bit-0 |
| [X] | 0 | 1 | SR[4F] | -Busy | -ACK | PE | SLCT | Error State | -IRQ | logic "1" | logic "1" |
| [X] | 0 | 1 | IOSEL | bit-7 | bit-6 | bit-5 | bit-4 | bit-3 | bit-2 | bit-1 | bit-0 |
| [X] | 1 | 0 | COM[E0] | logic "1" | logic "1" | logic "1" | -INTP Enable | -SLCTIN | INIT | -Auto FDXT | -STROBE |
| [X] | 1 | 0 | CON[00] | [X] | [X] | PD 0-7 IN/OUT | -INTP Enable | -SLCTIN | INIT | -Auto FDXT | -STROBE |

Note 1* The General Register set is accessible only when CS A or CS B is a logic 0.

Note 2* The Baud Rate register set is accessible only when CS A or CS B is a logic 0 and LCR bit-7 is a logic 1.

Note 3*: Printer Port Register set is accessible only when -CSP is a logic 0 in conjunction with the states of the interface signal BIDEN and Printer Control Register bit-5 or IOSEL register.

Note 5* The value between the square brackets represents the register's initialized HEX value, X = N/A.

UART REGISTER DESCRIPTIONS

Transmit (THR) and Receive (RHR) Holding Registers

The serial transmitter section consists of an 8-bit Transmit Hold Register (THR) and Transmit Shift Register (TSR). The status of the THR is provided in the Line Status Register (LSR). Writing to the THR transfers the contents of the data bus (D7-D0) to the THR, providing that the THR or TSR is empty. The THR empty flag in the LSR register will be set to a logic 1 when the transmitter is empty or when data is transferred to the TSR. Note that a write operation can be performed when the transmit holding register empty flag is set (logic 0 = Buffer full).

The serial receive section also contains an 8-bit Receive Holding Register, RHR. Receive data is removed from the 452/452PS by reading the RHR register. The receive section provides a mechanism to prevent false starts. On the falling edge of a start or false start bit, an internal receiver counter starts counting clocks at the 16x clock rate. After 7 1/2 clocks the start bit time should be shifted to the center of the start bit. At this time the start bit is sampled and if it is still a logic 0 it is validated. Evaluating the start bit in this manner prevents the receiver from assembling a false character. Receiver status codes will be posted in the LSR.

Interrupt Enable Register (IER)

The Interrupt Enable Register (IER) masks the interrupts from receiver ready, transmitter empty, line status and modem status registers. These interrupts would normally be seen on the INT A,B output pins.

IER BIT-0:

This interrupt will be issued when the RHR is full or is cleared when the RHR is empty.

Logic 0 = Disable the receiver ready interrupt. (normal default condition)

Logic 1 = Enable the receiver ready interrupt.

IER BIT-1:

This interrupt will be issued whenever the THR is empty and is associated with bit-1 in the LSR register.

Logic 0 = Disable the transmitter empty interrupt. (normal default condition)

Logic 1 = Enable the transmitter empty interrupt.

IER BIT-2:

This interrupt will be issued whenever a fully assembled receive character is transferred from the RSR to the RHR, i.e., data ready, LSR bit-0.

Logic 0 = Disable the receiver line status interrupt. (normal default condition)

Logic 1 = Enable the receiver line status interrupt.

IER BIT-3:

Logic 0 = Disable the modem status register interrupt. (normal default condition)

Logic 1 = Enable the modem status register interrupt.

IER BIT 4-7:

Not Used - initialized to a logic 0.

Interrupt Status Register (ISR)

The 452/452PS provides four levels of prioritized interrupts to minimize external software interaction. The Interrupt Status Register (ISR) provides the user with four interrupt status bits. Performing a read cycle on the ISR will provide the user with the highest pending interrupt level to be serviced. No other interrupts are acknowledged until the pending interrupt is serviced. Whenever the interrupt status register is read, the interrupt status is cleared. However it should be noted that only the current pending interrupt is cleared by the read. A lower level interrupt may be seen after rereading the interrupt status bits. The Interrupt Source Table 8 (below) shows the data values (bits 0-3) for the four prioritized interrupt levels and the interrupt sources associated with each of these interrupt levels:

Table 8, INTERRUPT SOURCE TABLE

| Priority Level | [ISR BITS] | | | | Source of the interrupt |
|----------------|------------|-------|-------|-------|--------------------------------------------|
| | Bit-3 | Bit-2 | Bit-1 | Bit-0 | |
| 1 | 0 | 1 | 1 | 0 | LSR (Receiver Line Status Register) |
| 2 | 0 | 1 | 0 | 0 | RXRDY (Received Data Ready) |
| 3 | 0 | 0 | 1 | 0 | TXRDY (Transmitter Holding Register Empty) |
| 4 | 0 | 0 | 0 | 0 | MSR (Modem Status Register) |

ISR BIT-0:

Logic 0 = An interrupt is pending and the ISR contents may be used as a pointer to the appropriate interrupt service routine.

Logic 1 = No interrupt pending. (normal default condition)

ISR BIT 1-3: (logic 0 or cleared is the default condition)

These bits indicate the source for a pending interrupt at interrupt priority levels 1, 2, and 3 (See Interrupt Source Table).

ISR BIT 4-7: (logic 0 or cleared is the default condition)

Not Used - initialized to a logic 0.

Line Control Register (LCR)

The Line Control Register is used to specify the asynchronous data communication format. The word length, the number of stop bits, and the parity are selected by writing the appropriate bits in this register.

LCR BIT 0-1: (logic 0 or cleared is the default condition)

These two bits specify the word length to be transmitted or received.

| BIT-1 | BIT-0 | Word length |
|-------|-------|-------------|
| 0 | 0 | 5 |
| 0 | 1 | 6 |
| 1 | 0 | 7 |
| 1 | 1 | 8 |

LCR BIT-2: (logic 0 or cleared is the default condition)

The length of stop bit is specified by this bit in conjunction with the programmed word length.

| BIT-2 | Word length | Stop bit length (Bit time(s)) |
|-------|-------------|-------------------------------|
| 0 | 5,6,7,8 | 1 |
| 1 | 5 | 1-1/2 |
| 1 | 6,7,8 | 2 |

LCR BIT-3:

Parity or no parity can be selected via this bit.

Logic 0 = No parity. (normal default condition)

Logic 1 = A parity bit is generated during the transmission, receiver checks the data and parity for transmission errors.

LCR BIT-4:

If the parity bit is enabled with LCR bit-3 set to a logic 1, LCR BIT-4 selects the even or odd parity format.

Logic 0 = ODD Parity is generated by forcing an odd number of logic 1's in the transmitted data. The receiver must be programmed to check the same format. (normal default condition)

Logic 1 = EVEN Parity is generated by forcing an even the number of logic 1's in the transmitted. The receiver must be programmed to check the same format.

LCR BIT-5:

If the parity bit is enabled, LCR BIT-5 selects the forced parity format.

LCR BIT-5 = logic 0, parity is not forced. (normal default condition)

LCR BIT-5 = logic 1 and LCR BIT-4 = logic 0, parity bit is forced to a logical 1 for the transmit and receive data.

LCR BIT-5 = logic 1 and LCR BIT-4 = logic 1, parity bit is forced to a logical 0 for the transmit and receive data.

| LCR Bit-5 | LCR Bit-4 | LCR Bit-3 | Parity selection |
|-----------|-----------|-----------|-------------------------|
| X | X | 0 | No parity |
| 0 | 0 | 1 | Odd parity |
| 0 | 1 | 1 | Even parity |
| 1 | 0 | 1 | Force parity odd parity |
| 1 | 1 | 1 | Forced even parity |

LCR BIT-6:

When enabled the Break control bit causes a break condition to be transmitted (the TX output is forced to a logic 0 state). This condition exists until disabled by setting LCR bit-6 to a logic 0.

Logic 0 = No TX break condition. (normal default condition)

Logic 1 = Forces the transmitter output (TX) to a logic 0 for alerting the remote receiver to a line break condition.

LCR BIT-7:

The internal baud rate counter latch and Enhance Feature mode enable.

Logic 0 = Divisor latch disabled. (normal default condition)

Logic 1 = Divisor latch and enhanced feature register enabled.

Modem Control Register (MCR)

This register controls the interface with the modem or a peripheral device.

MCR BIT-0:

Logic 0 = Force -DTR output to a logic 1. (normal default condition)

Logic 1 = Force -DTR output to a logic 0.

MCR BIT-1:

Logic 0 = Force -RTS output to a logic 1. (normal default condition)

Logic 1 = Force -RTS output to a logic 0.

MCR BIT-2:

This bit is used in the Loop-back mode only. In the

loop-back mode this bit is use to write the state of the modem -RI interface signal.

MCR BIT-3: (Used to control the modem -CD signal in the loop-back mode.)

Logic 0 = Forces INT (A-B) outputs to the three state mode. (normal default condition) In the Loop-back mode, sets -CD internally to a logic 1.

Logic 1 = Forces the INT (A-B) outputs to the active mode. In the Loop-back mode, sets -CD internally to a logic 0.

MCR BIT-4:

Logic 0 = Disable loop-back mode. (normal default condition)

Logic 1 = Enable local loop-back mode (diagnostics).

MCR BIT 5-7:

Not Used - initialized to a logic 0.

Line Status Register (LSR)

This register provides the status of data transfers between. the 452/452PS and the CPU.

LSR BIT-0:

Logic 0 = No data in receive holding register. (normal default condition)

Logic 1 = Data has been received and is saved in the receive holding register.

LSR BIT-1:

Logic 0 = No overrun error. (normal default condition)

Logic 1 = Overrun error. A data overrun error occurred in the receive shift register. This happens when additional data arrives while the RHR is full. In this case the previous data in the shift register is overwritten. Note that under this condition the data byte in the receive shift register is not transferred into the RHR, therefore the data in the RHR is not corrupted by the error.

LSR BIT-2:

Logic 0 = No parity error. (normal default condition)

Logic 1 = Parity error. The receive character does not have correct parity information and is suspect.

LSR BIT-3:

Logic 0 = No framing error. (normal default condition)
Logic 1 = Framing error. The receive character did not have a valid stop bit(s).

LSR BIT-4:

Logic 0 = No break condition. (normal default condition)
Logic 1 = The receiver received a break signal (RX was a logic 0 for one character frame time).

LSR BIT-5:

This bit indicates that the 452/452PS is ready to accept new characters for transmission. This bit causes the 452/452PS to issue an interrupt to the CPU when the transmit holding register is empty and the interrupt enable is set.

Logic 0 = Transmit holding register is not empty. (normal default condition)

Logic 1 = Transmit holding register is empty. When this bit is a logic 1, the CPU can load new character into the Transmit Holding Register for transmission.

LSR BIT-6:

Logic 0 = Transmitter holding and shift registers are full.

Logic 1 = Transmitter holding and shift registers are empty (normal default condition).

LSR BIT-7:

Not Used - initialized to a logic 0.

Modem Status Register (MSR)

This register provides the current state of the control interface signals from the modem, or other peripheral device that the 452/452PS is connected to. Four bits of this register are used to indicate the changed information. These bits are set to a logic 1 whenever a control input from the modem changes state. These bits are set to a logic 0 whenever the CPU reads this register.

MSR BIT-0:

Logic 0 = No -CTS Change (normal default condition)
Logic 1 = The -CTS input to the 452/452PS has

changed state since the last time it was read. A modem Status Interrupt will be generated.

MSR BIT-1:

Logic 0 = No -DSR Change. (normal default condition)
Logic 1 = The -DSR input to the 452/452PS has changed state since the last time it was read. A modem Status Interrupt will be generated.

MSR BIT-2:

Logic 0 = No -RI Change. (normal default condition)
Logic 1 = The -RI input to the 452/452PS has changed from a logic 0 to a logic 1. A modem Status Interrupt will be generated.

MSR BIT-3:

Logic 0 = No -CD Change. (normal default condition)
Logic 1 = Indicates that the -CD input to the has changed state since the last time it was read. A modem Status Interrupt will be generated.

MSR BIT-4:

Normally MSR bit-4 bit is the compliment of the -CTS input. However in the loop-back mode, this bit is equivalent to the RTS bit in the MCR register.

MSR BIT-5:

DSR (active high, logical 1). Normally this bit is the compliment of the -DSR input. In the loop-back mode, this bit is equivalent to the DTR bit in the MCR register.

MSR BIT-6:

RI (active high, logical 1). Normally this bit is the compliment of the -RI input. In the loop-back mode this bit is equivalent to MCR bit-2 in the MCR register.

MSR BIT-7:

CD (active high, logical 1). Normally this bit is the compliment of the -CD input. In the loop-back mode this bit is equivalent to MCR bit-3 in the MCR register.

Note: Whenever any MSR bit 0-3: is set to logic "1", a MODEM Status Interrupt will be generated.

Scratchpad Register (SPR)

The ST16C452/452PS provides a temporary data register to store 8 bits of user information.

PRINTER PORT REGISTER DESCRIPTIONS

Port Register (PR)

PR BIT 0-7:

Printer Data port (Bi-directional) - These pins are the eight bit data bus for transferring information to or from an external device (usually a printer). D0 is the least significant bit. PD7-PD0 are latched during a write cycle (output mode).

I/O Select Register (IOSEL) [452PS only]

This register is used in conjunction with the state of BIDEN to set the direction (input/output) of the PD7-PD0 data bus. This register is used only when BIDEN is a logic 0.

Logic 55 (Hex) + BIDEN 0 = PD7-PD0 are set for output mode

Logic AA (Hex) + BIDEN 0 = PD7-PD0 are set for input mode

Status Register (SR)

This register provides the printer port input logical states and the status of the interrupt -INTP based on the condition of the -ACK printer port interface signal. The logical state of these pins is dependent on external interface signals.

SR BIT 1-0:

Not Used - initialized to a logic 1.

SR BIT-2:

Logic 0 = an interrupt is pending

When INTSEL is a logic 0, SR bit-2 basically tracks the -ACK input interface pin (returns to a logic 1 when the -ACK input returns to a logic 1). However when INTSEL is a logic 1, the latched mode is selected, SR bit-2 goes to a logic 0 with the -ACK input but does not return to a logic 1 until the end of the read cycle, i.e., reading SR will set this bit to a logic 1.

Logic 1 = no interrupt is pending. (normal inactive state)

SR BIT-3:

Logic 0 = -ERROR input is a logic 0.

Logic 1 = -ERROR input is a logic 1. (normal inactive state)

SR BIT-4:

Logic 0 = SLCT input is a logic 0. (normal inactive state)

Logic 1 = SLCT input is a logic 1.

SR BIT-5:

Logic 0 = PE input is a logic 0. (normal inactive state)

Logic 1 = PE input is a logic 1.

SR BIT-6:

Logic 0 = -ACK input is a logic 0.

Logic 1 = -ACK input is a logic 1. (normal inactive state)

SR BIT-7:

Logic 0 = BUSY input is a logic 0

Logic 1 = BUSY input is a logic 1 (normal inactive state)

Command Register (COM)

This register provides the printer port input logical states and the status of the printer interrupt INIT, which is based on the state of CON bit-1.

COM BIT-0:

-STROBE is a bi-directional signal with an open source driver and internal pull-up so that it may be wire-or'd with other outputs. COM bit-1 is used to read status while CON bit 1 is used to set an output state. If it is to function as an input, CON bit-1 shall be set to a logic 1 first.

Logic 0 = -STROBE pin is a logic 1. (normal default condition)

Logic 1 = -STROBE pin is a logic 0.

COM BIT-1:

-AutoFDXT is a bi-directional signal with an open source driver and internal pull-up so that it may be wire-or'd with other outputs. COM bit-1 is used to read status while CON bit 1 is used to set an output state. If it is to function as an input, CON bit-1 shall be set to

a logic 1 first.

Logic 0 = -AutoFDXT pin is a logic 1. (normal default condition)

Logic 1 = -AutoFDXT pin is a logic 0.

COM BIT-2:

INIT is a bi-directional signal with an open source driver and internal pull-up so that it may be wire-or'd with other outputs. COM bit-2 is used to read status while CON bit 2 is used to set an output state. If it is to function as an input, CON bit-1 shall be set to a logic 1 first.

Logic 0 = INIT pin is a logic 0. (normal default condition)

Logic 1 = INIT pin is a logic 1.

COM BIT-3:

-SLCTIN is a bi-directional signal with an open source driver and internal pull-up so that it may be wire-or'd with other outputs. COM bit-1 is used to read status while CON bit 1 is used to set an output state. If it is to function as an input, CON bit-1 shall be set to a logic 1 first.

Logic 0 = -SLCTIN pin is a logic 1 (normal default condition)

Logic 1 = -SLCTIN pin is a logic 0

COM BIT-4:

This bit allows the state of -INTP to be read back by the external CPU.

Logic 0 = Interrupt (-INTP output) is disabled (normal default condition)

Logic 1 = Interrupt (-INTP output) is enabled

COM BIT 5-7:

Not Used - initialized to a logic 1.

Control Register (CON)

This register provides control of the printer port output logical states and controls the printer interrupts INIT and -INTP. With the exception of PD 0-7 IN/OUT, the status of this register may be read by reading the COM register.

CONBIT-0:

The -STROBE output control bit is under software control, i.e., the hardware will not generate a strobe. It is up to software to return the state of -STROBE to the inactive (logic 1) state. The hardware driver is open drain so that -STROBE may be wire-or'd. The state of this bit can be read using COM bit-0.

Logic 0 = -STROBE output is set to a logic 1. (normal default condition)

Logic 1 = -STROBE output is set to a logic 0.

CON BIT-1:

The -AutoFDXT output control bit is set by software using CON bit-1. The hardware driver is open drain so that -AutoFDXT may be wire-or'd. The state of this bit can be read using COM bit-1.

Logic 0 = -AutoFDXT output is set to a logic 1. (normal default condition)

Logic 1 = -AutoFDXT output is set to a logic 0.

CON BIT-2:

The INIT output control bit is set by software using CON bit-2. The hardware driver is open drain so that INIT may be wire-or'd. The state of this bit can be read using COM bit-2.

Logic 0 = INIT output is set to a logic 0. (normal default condition)

Logic 1 = INIT output is set to a logic 1.

CON BIT-3:

The -SLCTIN output control bit is set by software using CON bit-3. The hardware driver is open drain so that -AutoFDXT may be wire-or'd. The state of this bit can be read using COM bit-3.

Logic 0 = -SLCTIN output is set to a logic 1. (normal default condition)

Logic 1 = -SLCTIN output is set to a logic 0.

CON BIT-4:

This bit enables or masks the printer interrupt output -INTP. The state of this bit can be read using COM bit-4.

Logic 0 = Disable -INTP output. (normal default condition)

Logic 1 = Enable -INTP output.

CON BIT-5: [452PS only]

This bit is used in conjunction with the state of BIDEN to set the direction (input/output) of the PD7-PD0 data bus.

Logic 0 + BIDEN 1 = PD7-PD0 are set for output mode (normal default condition)

Logic 1 + BIDEN 1 = PD7-PD0 are set for input mode

CON BIT 6-7:

Not Used - initialized to a logic 1.

ST16C452/452PS EXTERNAL RESET CONDITION

| SIGNALS | RESET STATE |
|------------|-------------------|
| TX A/B | High |
| -RTS A/B | High |
| -DTR A/B | High |
| INT A/B, P | Three state mode |
| PD0-PD7 | Low, output mode |
| -STROBE | High, output mode |
| -AutoFDXT | High, output mode |
| INIT | Low, output mode |
| -SLCTIN | High, output mode |

| REGISTERS (UART) | RESET STATE |
|------------------|------------------------------------------------|
| IER | BITS 0-7=0 |
| ISR | ISR BIT-0=1, ISR BITS 1-7=0 |
| LCR | LCR BITS 0-7=0 |
| MCR | MCR BITS 0-7=0 |
| LSR | LSR BITS 0-4=0, LSR BITS 5-6=1 LSR, BIT 7=0 |
| MSR | MSR BITS 0-3=0, MSR BITS 4-7=input signals |

| REGISTERS Printer Port | RESET STATE |
|------------------------|---------------------------------------|
| IOSEL | IOSEL BITS-0-7=0 |
| SR | SR BITS 0-1=1, BITS 2-7=input signals |
| COM | COM BITS 0-4=0, BITS 5-7=1 |
| CON | CON BITS 0-5=0, BITS 6-7=1 |

AC ELECTRICAL CHARACTERISTICS

$T_A=0^\circ - 70^\circ\text{C}$ ($-40^\circ - +85^\circ\text{C}$ for Industrial grade packages), $V_{CC}=3.3 - 5.0\text{ V} \pm 10\%$ unless otherwise specified.

| Symbol | Parameter | Limits 3.3 | | Limits 5.0 | | Units | Conditions |
|------------------|------------------------------------------------|---------------|------------|---------------|------------|-------|-------------|
| | | Min | Max | Min | Max | | |
| T_{1w}, T_{2w} | Clock pulse duration | 17 | | 17 | | ns | |
| T_{3w} | Oscillator/Clock frequency | | 8 | | 24 | MHz | |
| T_{6s} | Address setup time | 5 | | 0 | | ns | |
| T_{7d} | -IOR delay from chip select | 10 | | 10 | | ns | |
| T_{7w} | -IOR strobe width | 35 | | 25 | | ns | |
| T_{7h} | Chip select hold time from -IOR | 0 | | 0 | | ns | |
| T_{9d} | Read cycle delay | 40 | | 30 | | ns | |
| T_{12d} | Delay from -IOR to data | | 35 | | 25 | ns | |
| T_{12h} | Data disable time | | 25 | | 15 | ns | |
| T_{13d} | -IOW delay from chip select | 10 | | 10 | | ns | |
| T_{13w} | -IOW strobe width | 40 | | 25 | | ns | |
| T_{13h} | Chip select hold time from -IOW | 0 | | 0 | | ns | |
| T_{15d} | Write cycle delay | 40 | | 30 | | ns | |
| T_{16s} | Data setup time | 20 | | 15 | | ns | |
| T_{16h} | Data hold time | 5 | | 5 | | ns | |
| T_{17d} | Delay from -IOW to output | | 50 | | 40 | ns | 100 pF load |
| T_{18d} | Delay to set interrupt from MODEM input | | 40 | | 35 | ns | 100 pF load |
| T_{19d} | Delay to reset interrupt from -IOR | | 40 | | 35 | ns | 100 pF load |
| T_{20d} | Delay from stop to set interrupt | | 1 | | 1 | Rclk | |
| T_{21d} | Delay from -IOR to reset interrupt | | 45 | | 40 | ns | 100 pF load |
| T_{22d} | Delay from stop to interrupt | | 45 | | 40 | ns | |
| T_{23d} | Delay from initial INT reset to transmit start | 8 | 24 | 8 | 24 | Rclk | |
| T_{24d} | Delay from -IOW to reset interrupt | | 45 | | 40 | ns | |
| T_{39w} | -ACK pulse width | 75 | | 75 | | ns | |
| T_{40s} | PD7 - PD0 setup time | 15 | | 10 | | ns | |
| T_{41h} | PD7 - PD0 hold time | 30 | | 25 | | ns | |
| T_{42d} | Delay from -ACK low to interrupt low | 10 | | 5 | | ns | |
| T_{43d} | Delay from -IOR to reset interrupt | 10 | | 5 | | ns | |
| T_R | Reset pulse width | 40 | | 40 | | ns | |
| N | Baud rate divisor | 1 | $2^{16}-1$ | 1 | $2^{16}-1$ | Rclk | |

ABSOLUTE MAXIMUM RATINGS

| | |
|-----------------------|---------------------------|
| Supply range | 7 Volts |
| Voltage at any pin | GND - 0.3 V to VCC +0.3 V |
| Operating temperature | -40° C to +85° C |
| Storage temperature | -65° C to 150° C |
| Package dissipation | 500 mW |

DC ELECTRICAL CHARACTERISTICS

$T_A=0^\circ - 70^\circ\text{C}$ ($-40^\circ - +85^\circ\text{C}$ for Industrial grade packages), $V_{CC}=2.97 - 5.5\text{V}$ unless otherwise specified.

| Symbol | Parameter | Limits 3.3 | | Limits 5.0 | | Units | Conditions |
|------------|-----------------------------------------|---------------|----------|---------------|----------|---------------|------------------------|
| | | Min | Max | Min | Max | | |
| V_{ILCK} | Clock input low level | -0.3 | 0.6 | -0.5 | 0.6 | V | |
| V_{IHCK} | Clock and printer port input high level | 2.4 | VCC | 3.0 | VCC | V | |
| V_{IL} | Input low level | -0.3 | 0.8 | -0.5 | 0.8 | V | |
| V_{IH} | Input high level (Rev "E" and older) | 2.0 | VCC | 2.2 | VCC | V | |
| V_{IH} | Input high level (Rev "F" and newer) | 2.0 | 5.5 | 2.2 | 5.5 | V | |
| V_{OL} | Output low level on all outputs | | | | 0.4 | V | $I_{OL}= 4\text{ mA}$ |
| V_{OL} | Output low level on all outputs | | 0.4 | | | V | $I_{OL}= 4\text{ mA}$ |
| V_{OH} | Output high level | | | 2.4 | | V | $I_{OH}= -4\text{ mA}$ |
| V_{OH} | Output high level | 2.0 | | | | V | $I_{OH}= -1\text{ mA}$ |
| I_{IL} | Input leakage | | ± 10 | | ± 10 | μA | |
| I_{CL} | Clock leakage | | ± 10 | | ± 10 | μA | |
| I_{CC} | Avg power supply current | | 2.5 | | 5 | mA | |
| C_P | Input capacitance | | 5 | | 5 | pF | |
| R_{IN} | Internal pull-up resistance | 9 | | | 22 | k Ω | |

Note: See the Symbol Description Table, for a listing of pins having internal pull-up resistors.

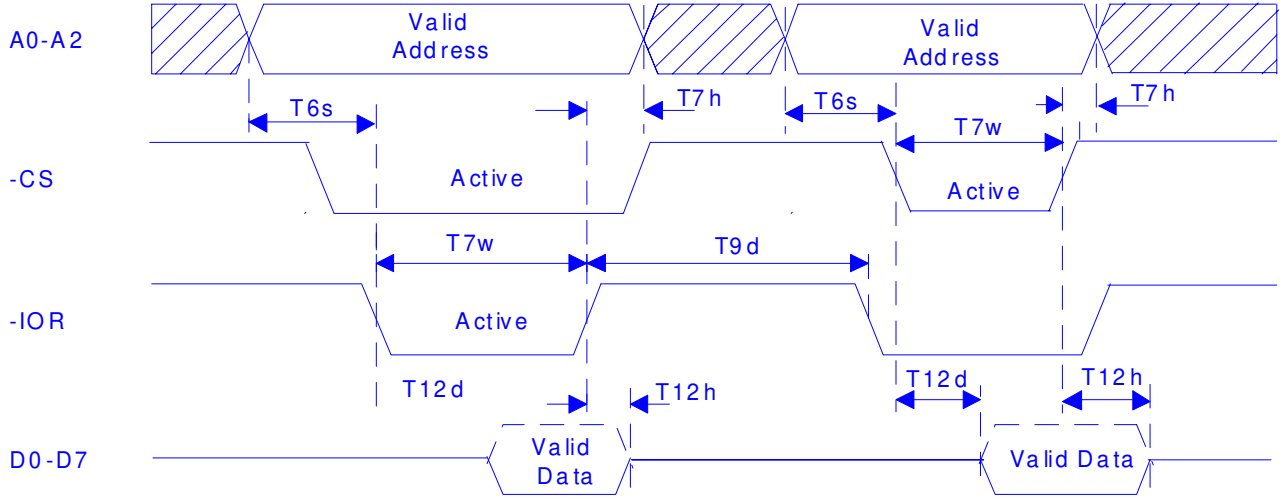

X552-RD-2

General read timing

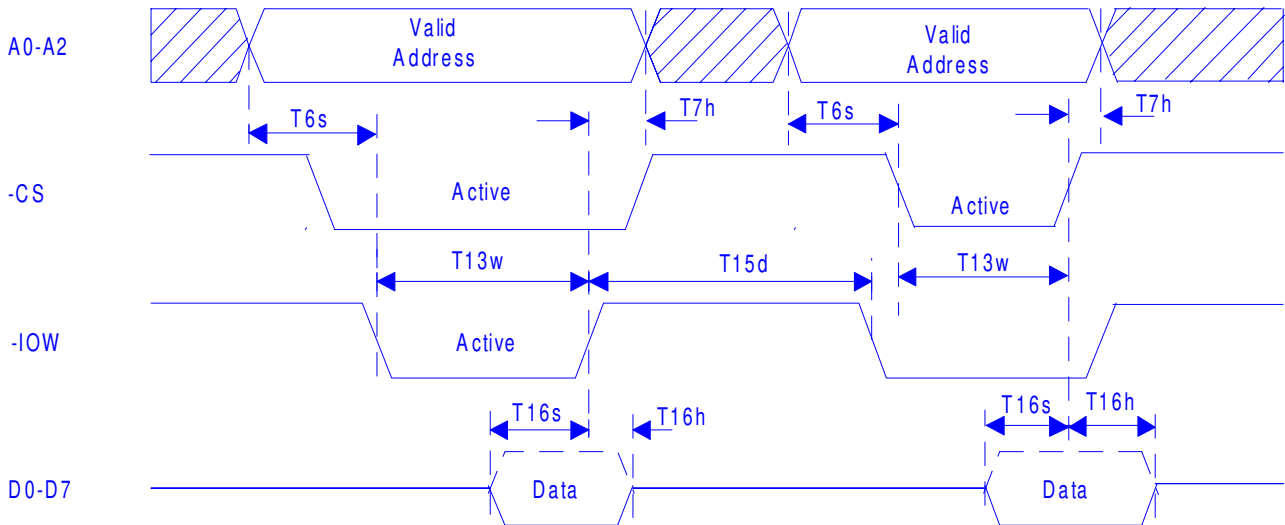

X552-RD-2

General write timing

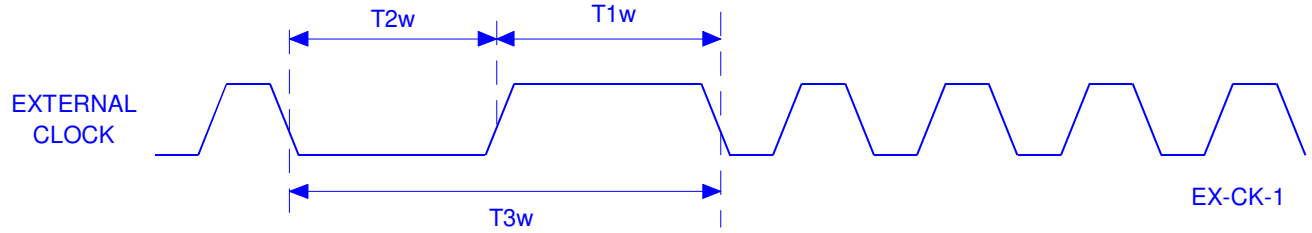

External clock timing

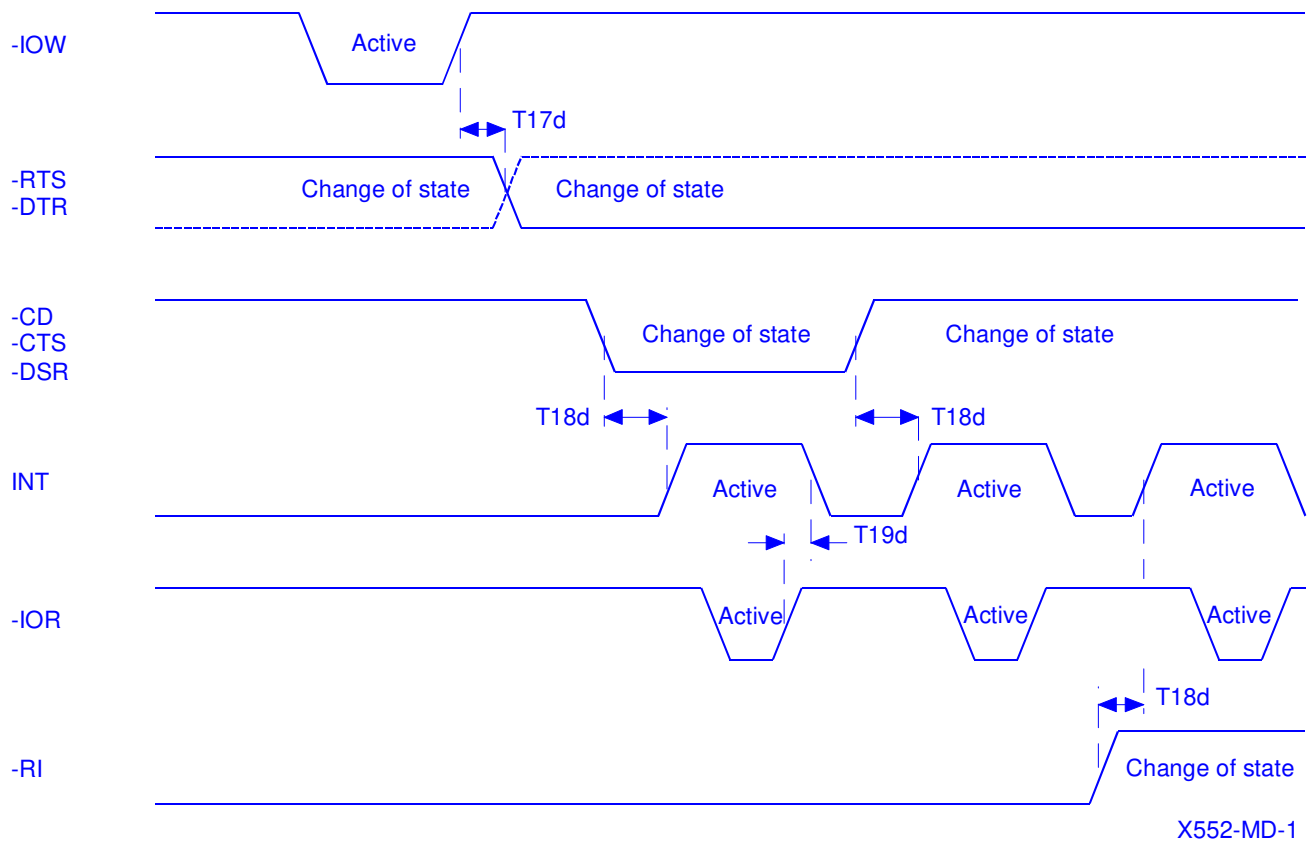

Modem input/output timing