



Chipsmall Limited consists of a professional team with an average of over 10 year of expertise in the distribution of electronic components. Based in Hongkong, we have already established firm and mutual-benefit business relationships with customers from,Europe,America and south Asia,supplying obsolete and hard-to-find components to meet their specific needs.

With the principle of “Quality Parts,Customers Priority,Honest Operation,and Considerate Service”,our business mainly focus on the distribution of electronic components. Line cards we deal with include Microchip,ALPS,ROHM,Xilinx,Pulse,ON,Everlight and Freescale. Main products comprise IC,Modules,Potentiometer,IC Socket,Relay,Connector.Our parts cover such applications as commercial,industrial, and automotives areas.

We are looking forward to setting up business relationship with you and hope to provide you with the best service and solution. Let us make a better world for our industry!



Contact us

Tel: +86-755-8981 8866 Fax: +86-755-8427 6832

Email & Skype: info@chipsmall.com Web: www.chipsmall.com

Address: A1208, Overseas Decoration Building, #122 Zhenhua RD., Futian, Shenzhen, China





Demonstration kit for single and double axis gyroscopes in a 4 x 5 mm package

Introduction

This document applies to all demonstration kits related to ST MEMS single and double axis gyroscopes in 4 x 5 mm packages, hereafter referred to as “STEVAL-MKI0xxV1”.

The STEVAL-MKI0xxV1 is a demonstration kit designed to provide the user with a complete, ready-to-use platform for demonstration of the LPR4xxAL and LPR4xxxAL product families.

The device includes a sensing element and an IC interface capable of translating information from the sensing element into a measured signal that can be used for external applications.

In addition to the MEMS sensor, the demonstration board utilizes an ST72651AR6 microcontroller which functions as a bridge between the sensor and the PC, on which it is possible to use the downloadable graphical user interface (GUI), or dedicated software routines for customized applications.

This user manual describes the hardware included with the demonstration kit and provides the information required to install and run the demonstration kit user interface.

For details regarding the features of each member of the LPR4xxAL and LPR4xxxAL sensor families, please refer to the datasheets available for each single device.

Contents

- 1 Demonstration kit description 5**

- 2 Working modes 7**
 - 2.1 Analog working mode (AWM) 7
 - 2.2 Digital working mode (DWM) 8
 - 2.3 Additional settings 9

- 3 STEVAL-MKI0xxV1 GUI installation 10**
 - 3.1 PC system requirements 10
 - 3.2 Software installation 10
 - 3.3 Hardware installation 11

- 4 Graphical user interface 14**
 - 4.1 Connecting to the virtual COM port 15
 - 4.2 GUI main window functions 15
 - 4.2.1 “Easy Start” button 15
 - 4.2.2 “Home” tab 16
 - 4.2.3 “Options” tab 16
 - 4.2.4 “Bars” tab 17
 - 4.2.5 “Plot” tab 18
 - 4.2.6 “Data” tab 20
 - 4.2.7 “FFT” tab 21

- 5 Data acquisition quick start 22**

- 6 STEVAL-MKI0xxV1 Lite 23**

- 7 Supported commands 24**
 - 7.1 Getting started 24
 - 7.2 Supported commands 24
 - 7.2.1 Start command (DWM only) 25
 - 7.2.2 Debug command (DWM only) 25
 - 7.2.3 Stop command (DWM only) 26
 - 7.2.4 Zon and Zoff 26

| | | | |
|-----------|--------------------------------|------------------------|----|
| | 7.2.5 | Device name | 26 |
| | 7.2.6 | Firmware version | 26 |
| | 7.3 | Quick start | 26 |
| 8 | DFU | 27 | |
| | 8.1 | PC requirements | 27 |
| | 8.2 | DFU procedure | 27 |
| 9 | Schematic diagram | 30 | |
| 10 | Bill of materials | 31 | |
| 11 | Revision history | 33 | |

List of tables

| | | |
|----------|--|----|
| Table 1. | Jumper configurations for power down (PD), self-test (ST) and high pass filter reset (HP) in AWM. | 7 |
| Table 2. | Jumper configurations for JP1 and JP6 in AWM | 8 |
| Table 3. | Jumper configurations for JP9 and JP8 in AWM | 8 |
| Table 4. | Jumper configuration for DWM | 8 |
| Table 5. | Supported commands | 24 |
| Table 6. | Bill of materials | 31 |
| Table 7. | Document revision history | 33 |

List of figures

| | | |
|------------|--|----|
| Figure 1. | Demonstration board block diagram | 5 |
| Figure 2. | Top silk screen of the STEVAL-MKI0xxV1 demonstration board | 6 |
| Figure 3. | Top view of the STEVAL-MKI0xxV1 demonstration board | 6 |
| Figure 4. | Software installation | 10 |
| Figure 5. | Notify icon | 11 |
| Figure 6. | Driver installation using the device manager | 11 |
| Figure 7. | USB driver installation using the hardware update wizard | 12 |
| Figure 8. | Virtual COM driver port assignment | 13 |
| Figure 9. | Graphical user interface: main window | 14 |
| Figure 10. | Home tab | 16 |
| Figure 11. | Options tab | 16 |
| Figure 12. | Bars tab - angular rate data | 17 |
| Figure 13. | Plot tab | 18 |
| Figure 14. | Plot tab - zoom | 19 |
| Figure 15. | Data tab | 20 |
| Figure 16. | FFT tab | 21 |
| Figure 17. | STEVAL-MKI0xxV1 Lite GUI | 23 |
| Figure 18. | Demonstration kit correctly recognized | 27 |
| Figure 19. | Select new firmware | 28 |
| Figure 20. | Flash erasing | 29 |
| Figure 21. | Flash upgrading | 29 |
| Figure 22. | Schematic diagram of the STEVAL-MKI0xxV1 board | 30 |

1 Demonstration kit description

The STEVAL-MK10xxV1 is a complete demonstration kit that allows evaluation of the performance of the LPR4xxAL and LPR4xxxAL low-power double/single-axis gyroscopes with analog outputs.

The block diagram of the demonstration board included in the kit is shown in *Figure 1*.

Figure 1. Demonstration board block diagram

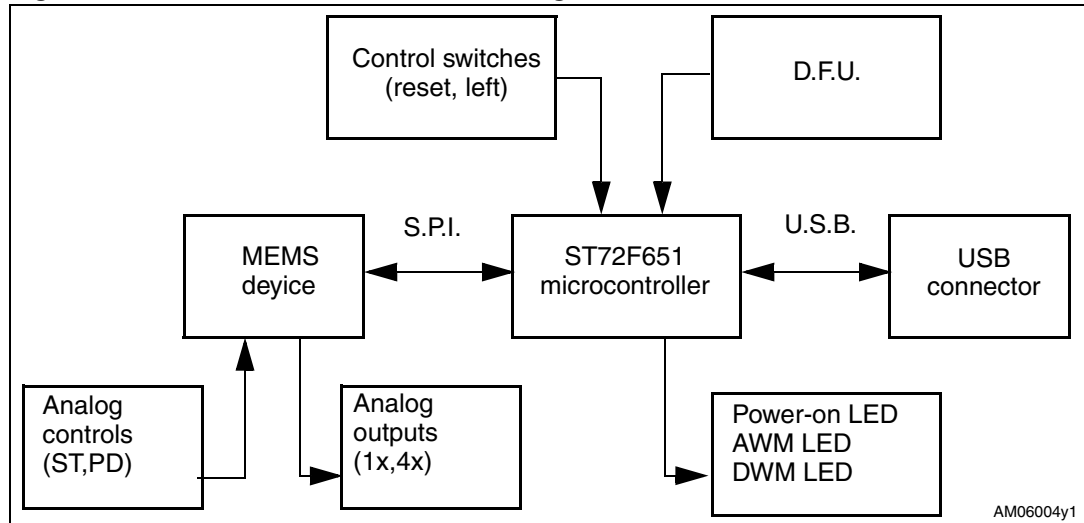

The analog outputs of the device are directly available through a dedicated connector. The ST72651AR6 microcontroller included on the board acquires and converts the analog outputs into digital signals, and provides the data to the user on the PC through the GUI provided with the kit.

The device firmware upgrade (DFU) is a feature allowing users to upgrade the firmware of the ST7 microcontroller whenever a new firmware release is available on www.st.com.

Switches and LED indicators are used to control and monitor the functionality of the board.

The top silk screen view and photo of the full board, respectively, are shown in *Figure 2* and *Figure 3*.

Figure 2. Top silk screen of the STEVAL-MKI0xxV1 demonstration board

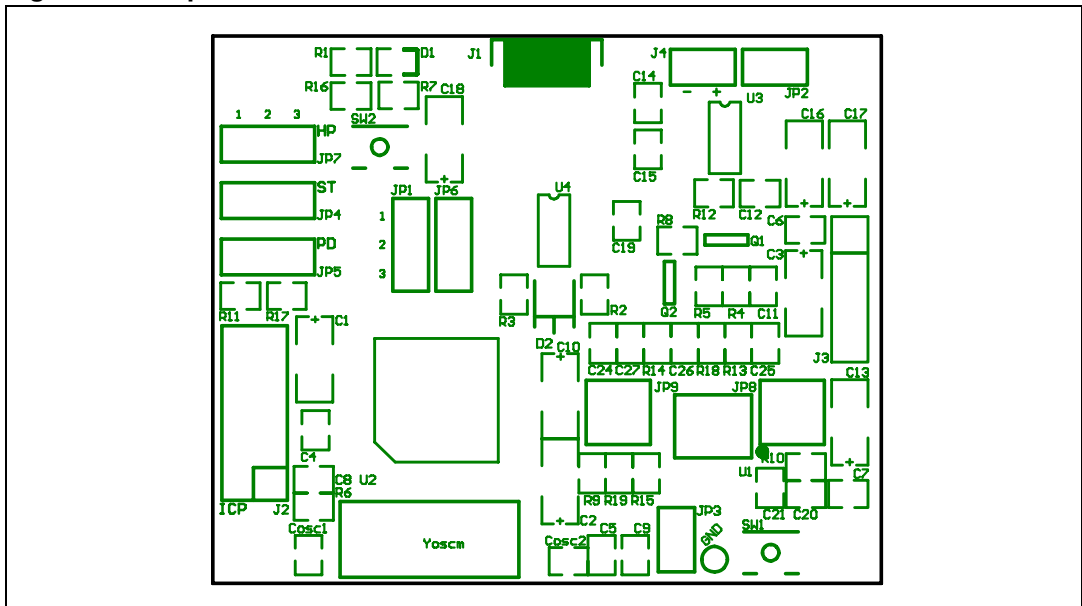
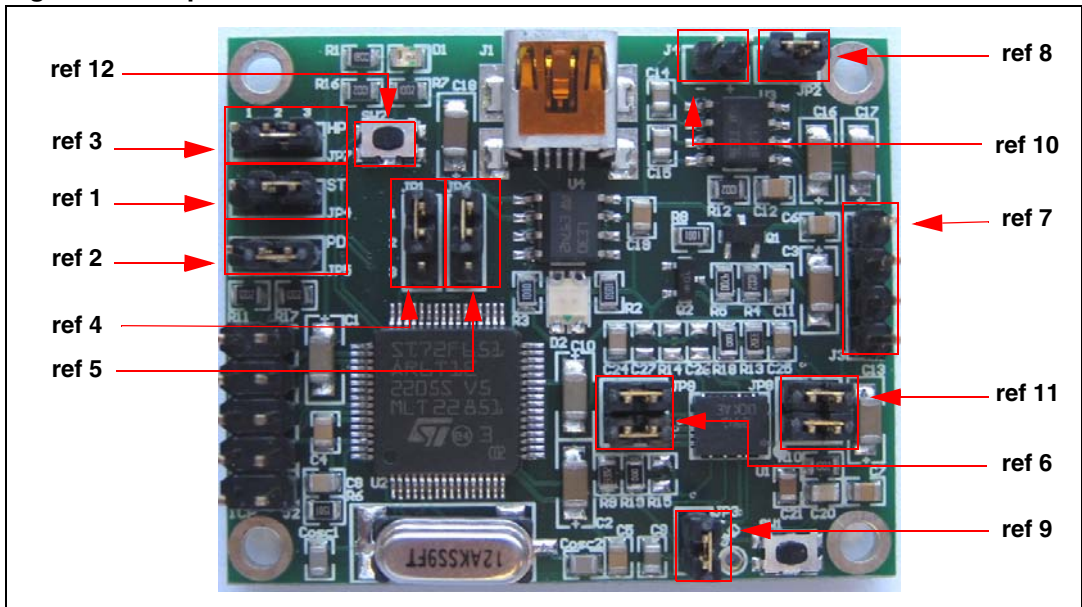

Figure 3. Top view of the STEVAL-MKI0xxV1 demonstration board



Operation of the STEVAL-MKI0xxV1 demonstration kit requires the installation of a dedicated driver which is included in the installation pack, together with a GUI interface which allows simple interaction with the sensor. The steps required for driver and software installation are described in the sections that follow.

2 Working modes

The STEVAL-MKI0xxV1 demonstration board is designed to be used in two different working modes:

- *Analog working mode (AWM)*: the microcontroller on the board is disabled and the analog outputs of the device are available to the user on the dedicated connector ([Figure 3](#), ref 7). This is the default working mode when power is applied either through the USB connector or through the supply connector ([Figure 3](#), ref 10).
- *Digital working mode (DWM)*: the microcontroller on the board is enabled and allows the user to digitally acquire the output signals of the device, to see them on the PC through the dedicated GUI and to manage the control pins of the device.

Each working mode requires a board setup, which is done by correctly setting the jumpers labeled JP4, JP5, JP7 (see ref 1, ref 2 and ref 3, respectively, in [Figure 3](#)) and the jumpers labeled JP1 and JP6 (see ref 4 and ref 5, respectively, in [Figure 3](#)).

2.1 Analog working mode (AWM)

AWM is the working mode activated by default when the board is connected to a PC by USB or when the power supply is applied to J10. The microcontroller on the board is disabled and board behavior can be controlled through the dedicated jumpers.

In this working mode, the power down (PD), self-test (ST) and high-pass filter reset (HP) functions are respectively managed by JP4, JP5 and JP7 as described below (see [Figure 3](#) to identify the jumpers):

Table 1. Jumper configurations for power down (PD), self-test (ST) and high pass filter reset (HP) in AWM

| | Jumper on 1-2 position | Jumper on 2-3 position |
|-------------------|--|---------------------------------------|
| JP4 ST | Logic level 1: self-test ON | Logic level 0: self-test OFF, default |
| JP5 PD | Logic level 1: power down mode | Logic level 0: normal mode, default |
| JP7 HP | Logic level 1: external high-pass filter reset | Logic level 0: normal mode, default |

Analog output signals can be measured respectively through pin 3 (marked Out1), pin 4 (marked Out2, for single-axis devices only) and pin1 (GND) of the J3 header (see [Figure 3](#), ref 7).

The JP1 and JP6 jumpers allow the user to select which output signal is available on J3.

Table 2. Jumper configurations for JP1 and JP6 in AWM

| | Jumper on 1-2 position | Jumper on 2-3 position |
|------------------------|--|--|
| JP1¹ | 1xOut1 (not amplified): on J3-pin 3 (Out1) | 4xOut1 (amplified): on J3-pin 3 (Out1) |
| JP6 | 1xOut2 (not amplified): on J3-pin 4 (Out2) | 4xOut2 (amplified): on J3-pin 4 (Out2) |

Note: *Not connected for single axis devices*

The JP9 and JP8 (for double axis devices only; see [Figure 3](#), ref 6 and ref 11) jumpers allow the management of external (HP and LP) filters, respectively, for Out2 and Out1.

Table 3. Jumper configurations for JP9 and JP8 in AWM

| Configuration | Function |
|--------------------------------|----------------------------|
| pin 1-2 short pin 3-4 short | HP and LP filters enabled |
| pin 2-4 open pin 3-4 short | HP and LP filters bypassed |

Note: *Not connected for single axis devices.*

2.2 Digital working mode (DWM)

When the board is configured for DWM, it can be controlled by a PC through the dedicated GUI. The USB works as an interface channel between the PC and demonstration kit board by means of the microcontroller. The microcontroller takes advantage of its on-board 8-bit A/D converter to read analog values from the device and to convert them in digital values, then sends them to the PC via the USB channel.

For the board to work in DWM, the jumpers must be configured as described in [Table 4](#).

Table 4. Jumper configuration for DWM

| Jumper | JUMPER position |
|-------------|----------------------------------|
| JP4 ST | 2-3 (default) or not connected |
| JP5 PD | 2-3 (default) or not connected |
| JP7 HP | 2-3 (default) or not connected |
| JP1 and JP6 | Refer to Table 1 |
| JP9 and JP8 | Refer to Table 3 |

Users can interact with the board by means of the STEVAL-MKI0xxV1 GUI and/or Microsoft[®] Hyper Terminal (refer to [Section 4](#) and [Section 7](#)).

2.3 Additional settings

JP2 must be present on the board to enable the DFU feature ([Figure 3](#), ref 8). For detailed information on the DFU feature, see [Section 8](#).

JP3 allows the measurement of current consumption ([Figure 3](#), ref 9)

J4 (usually open) is used to supply the board, alternatively, through a USB connection ([Figure 3](#), ref 10).

3 STEVAL-MK10xxV1 GUI installation

The installation of the graphical user interface (GUI) for the STEVAL-MK10xxV1 requires two steps:

1. installation of the software downloaded from www.st.com
2. installation of the virtual COM driver needed to use the demonstration kit

3.1 PC system requirements

Both the hardware and software that compose the STEVAL-MK10xxV1 demonstration kit have been designed to operate with Microsoft® Windows XP.

3.2 Software installation

To install the software:

1. double-click on "Setup.exe".
2. follow the on-screen instructions (*Figure 4*).

Figure 4. Software installation

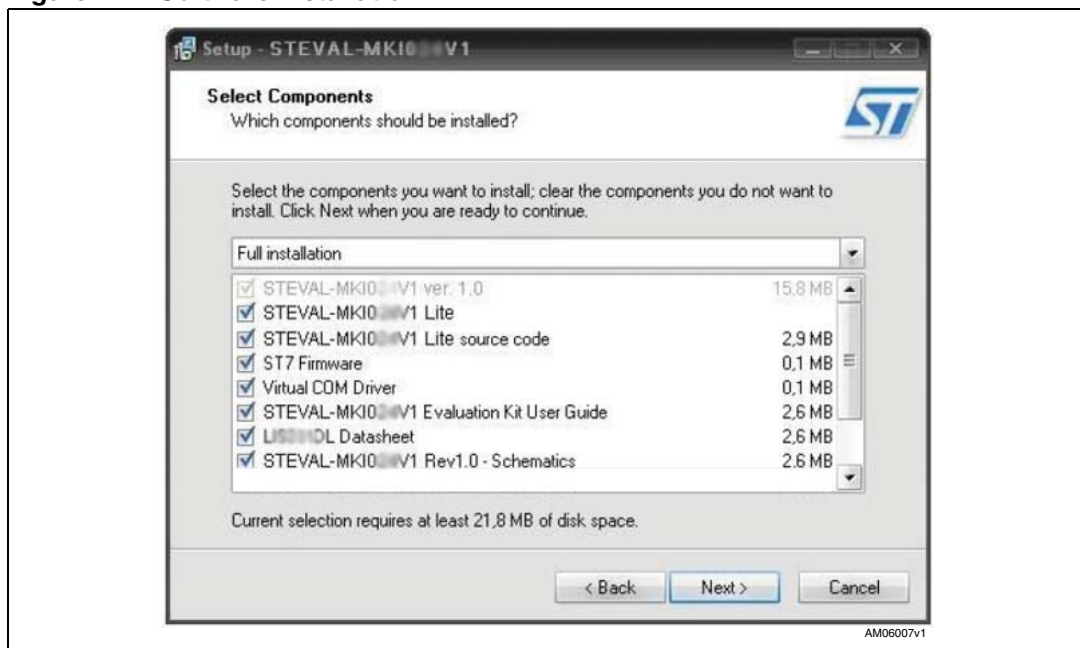

3.3 Hardware installation

To install the virtual COM driver, insert the demonstration kit board into a free USB port. The “notify” icon should appear as in [Figure 5](#).

Figure 5. Notify icon

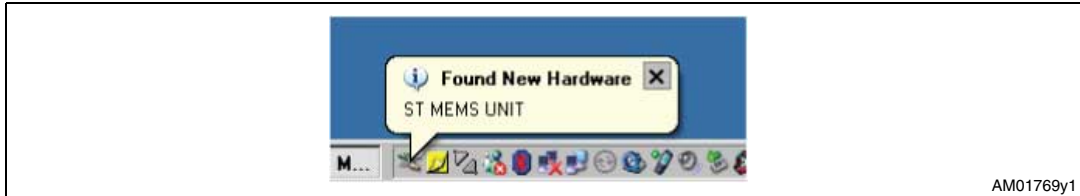

If the “hardware update wizard” window appears ([Figure 7](#)), follow the instructions on the screen, otherwise, the installation can be performed by following the instructions indicated in [Figure 6](#) and then [Figure 7](#).

Figure 6. Driver installation using the device manager

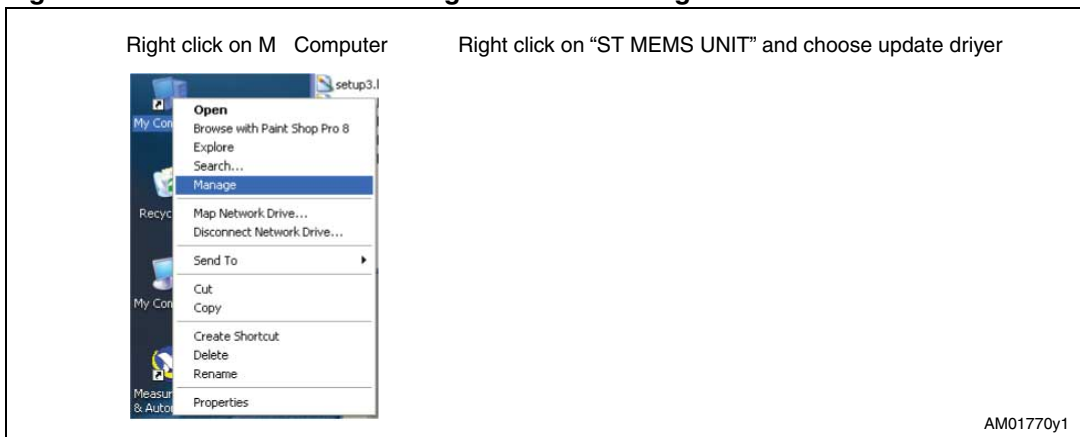
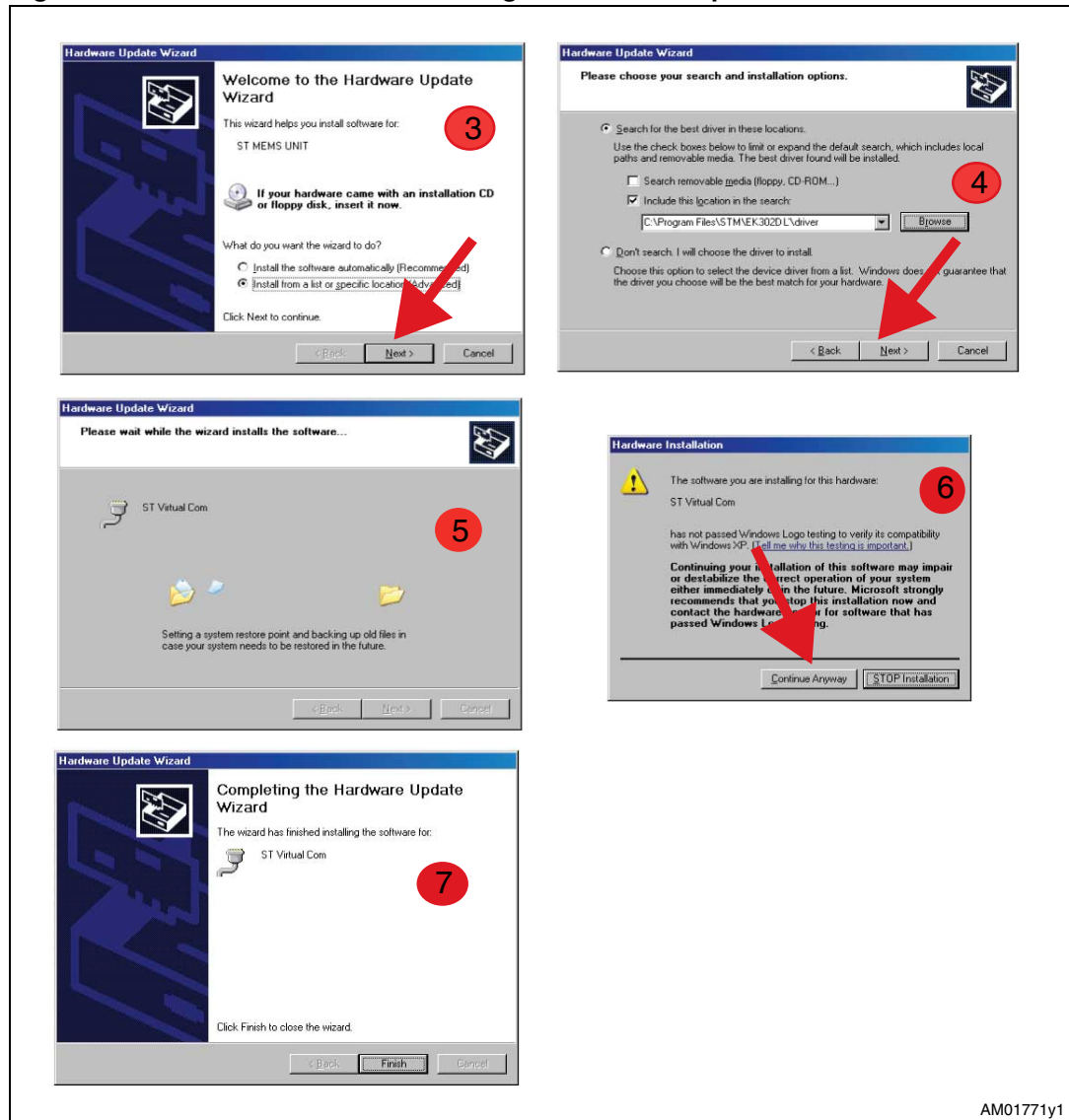

Figure 7. USB driver installation using the hardware update wizard



AM01771y1

Once the installation is complete, a COM port number is assigned to the ST virtual COM driver (*Figure 8*). This number should be retained, as it is required to run the STEVAL-MK10xxV1 demonstration software GUI. For additional details, see *Section 4.1*.

Figure 8. Virtual COM driver port assignment

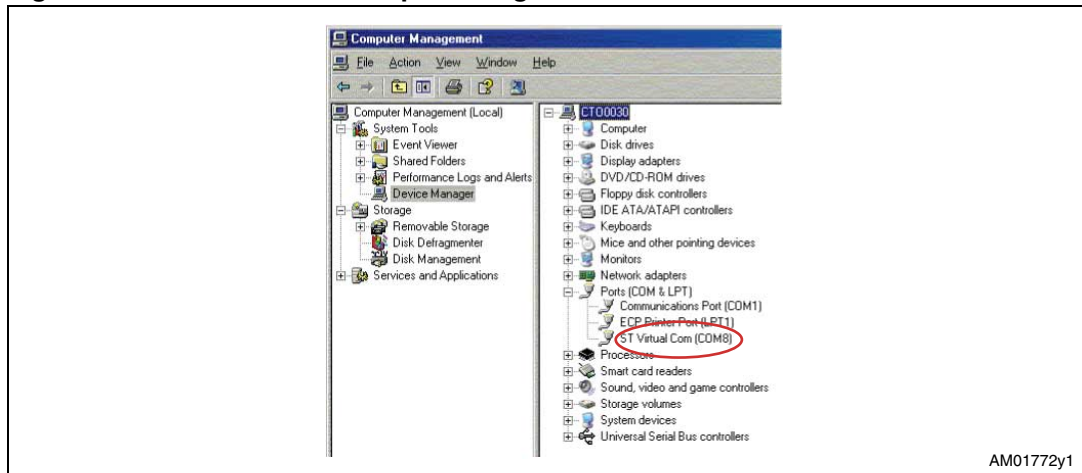

AM01772y1

4 Graphical user interface

To run the STEVAL-MKI0xxV1 demonstration software GUI:

1. Click on Start > All Programs.
2. Select STEVAL-MKI0xxV1 > Executables.
3. Launch the program “STEVAL-MKI0xxV1 Ver.0.0.1”.

The GUI main window appears as shown in [Figure 9](#).

Figure 9. Graphical user interface: main window

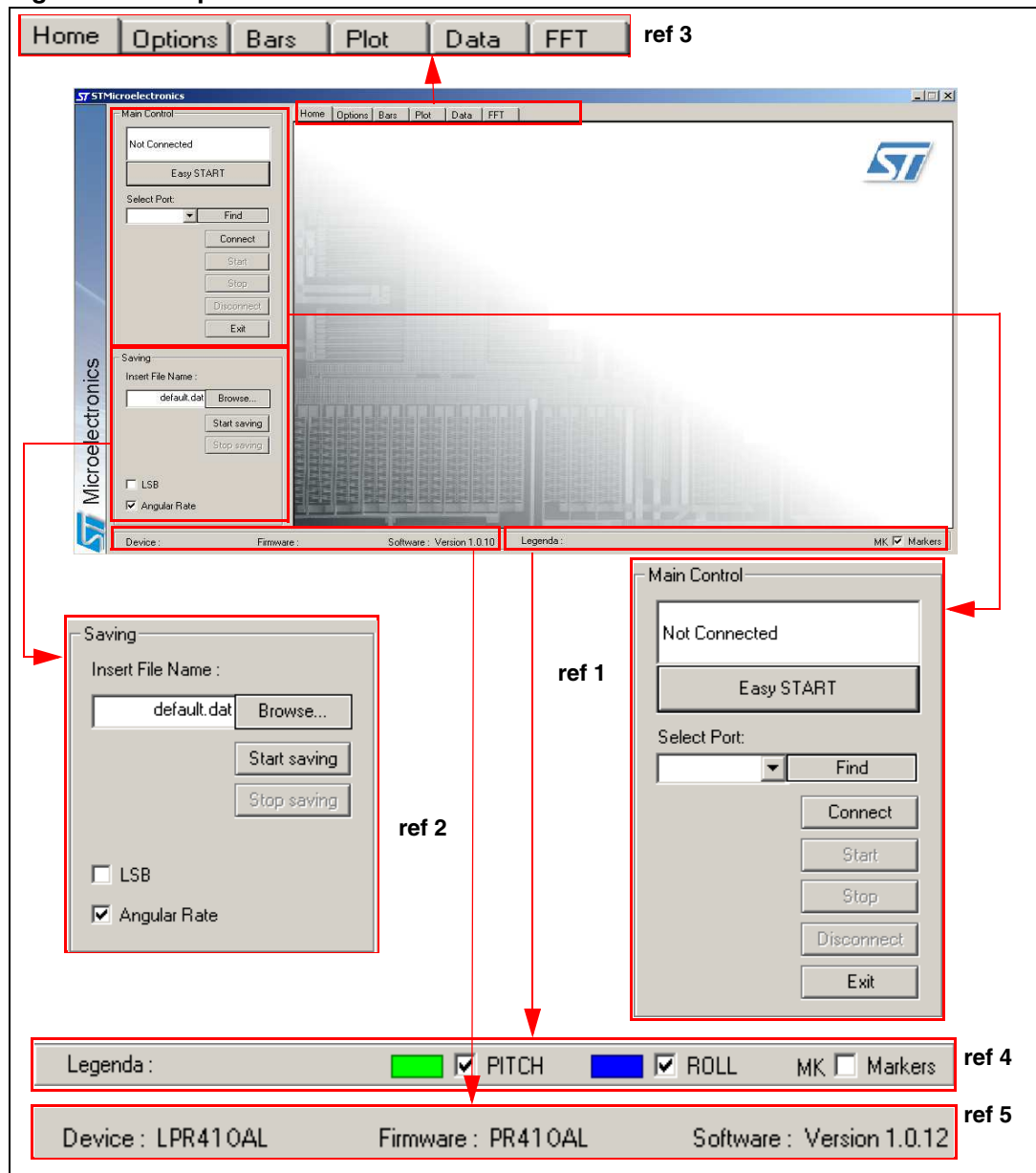

The functions of the four main sections of the window are described below:

1. “Main control” (*Figure 9*, ref 1) - connects/disconnects the board and starts acquisition via the Start/Stop buttons.
2. “Saving” box (*Figure 9*, ref 2) - allows the user to save the data to a specified text file, choosing the data type to write. Data types available are:
 - a) LSB: the analog values measured by the 8-bit A/D converter of the microcontroller are converted to 8-bit values, hence the 256 magnitude levels.
 - b) Angular rate: LSB data are multiplied by the sensitivity to obtain the angular rate, expressed in deg/sec.
3. “Tab selector” (*Figure 9*, ref 3) - used to toggle between the different features of the demonstration kit.
4. “Legend” (*Figure 9*, ref 4) - used to enable/disable viewing the axes.
5. “Details” (*Figure 9*, ref 5) - shows information about the demonstration kit, such as the name of the sensor, the version of the firmware loaded on the microcontroller and the version of the PC software.

4.1 Connecting to the virtual COM port

Before using the functions of the demonstration kit software, the connection with the STEVAL-MKI0xxV1 board must be opened using the following steps:

1. Connect the STEVAL-MKI0xxV1 to the desired USB port.
2. In the “Select COM” drop-down menu (*Figure 9* ref 1), choose the virtual COM number to which the board has been mapped. For additional information on how to obtain this number, see section 3.3. Otherwise, press “Find” to automatically get the correct COM number.
3. Open the connection by clicking on “Connect” (*Figure 9* ref 1). Opening the connection starts the board model recognition flow. If the flow terminates successfully, a recognized board code and mounted device code is generated and written on the “Home” tab. Otherwise, a message on the same tab alerts the user to check the board.

At this point, the user can acquire, plot and save the angular rate data measured by the sensor and access the content of the registers embedded in the device.

If the “Find” button is pressed (*Figure 9* ref 1), the GUI attempts to automatically find the COM number assigned to the demonstration kit, and displays it in the list box as a selected item.

4.2 GUI main window functions

The following sections provide details regarding the functions of the tabs and buttons on the GUI main window (see *Figure 9*).

4.2.1 “Easy Start” button

When the “Easy Start” button is clicked (*Figure 9*, ref 1), the GUI attempts to automatically find the COM number assigned to the demonstration kit, to recognize the connected board and its device and, if successful, starts the acquisition. If recognition is unsuccessful, a message alerts the user to verify that the board type is in the list of managed ones, or to update the SW.

4.2.2 “Home” tab

This tab is used to show the codes of managed and recognized devices and demonstration boards (*Figure 11*). In case of unmanaged devices, a message is shown on the tab.

Figure 10. Home tab



4.2.3 “Options” tab

The options tab allows the user to control the following parameters:

1. Operating mode (OM): allows the customer to select the operating mode: Normal Mode, Power Down Mode (*Figure 11*, ref 1).
2. OUTPUT Amplification/FullScale Selection: allows the selection of the data to be acquired and plotted by the GUI between 1x amplification and 4X amplification (*Figure 11*, ref 2).
3. Self Test (ST): enables the self-test function. (*Figure 11*, ref 3).
4. High Pass Filter (HPF) Reset: allows user to reset the internal high-pass filter (*Figure 11*, ref 4).

Figure 11. Options tab

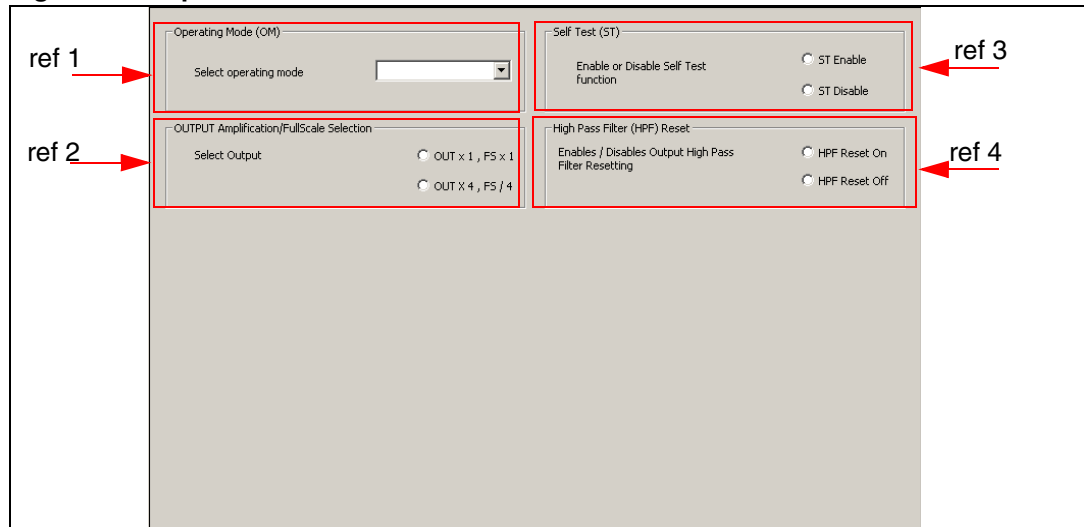

4.2.4 “Bars” tab

The bars tab (*Figure 12*) displays the available (pitch, roll and/or yaw) angular rate data measured by the device in a bar chart format (see *Figure 9*, ref 4).

The height of the bar is determined by the amplitude of the signal measured around the axis. The full scale of the graph is fixed to 2 times the selected full scale of the selected device.

Figure 12. Bars tab - angular rate data

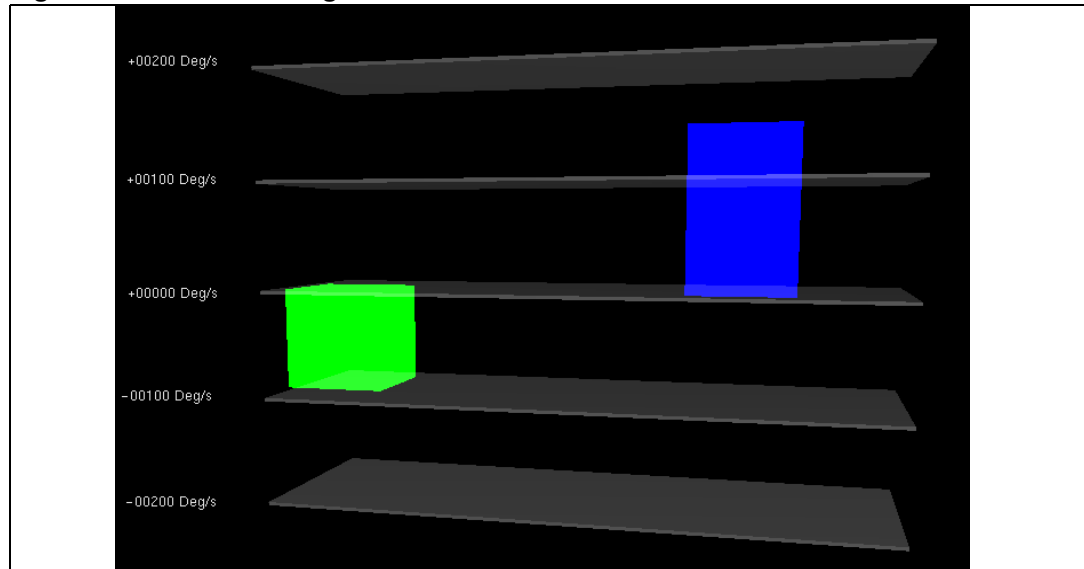

4.2.5 “Plot” tab

The plot tab (*Figure 13*) shows the sequence of selected angular rate samples that have been measured by the MEMS sensor and converted by the A/D converter.

The tab shows the “angular rate values” (*Figure 13*, ref 1) the numeric values of angular rates samples that have been measured by the sensor expressed as deg/sec.

Figure 13. Plot tab

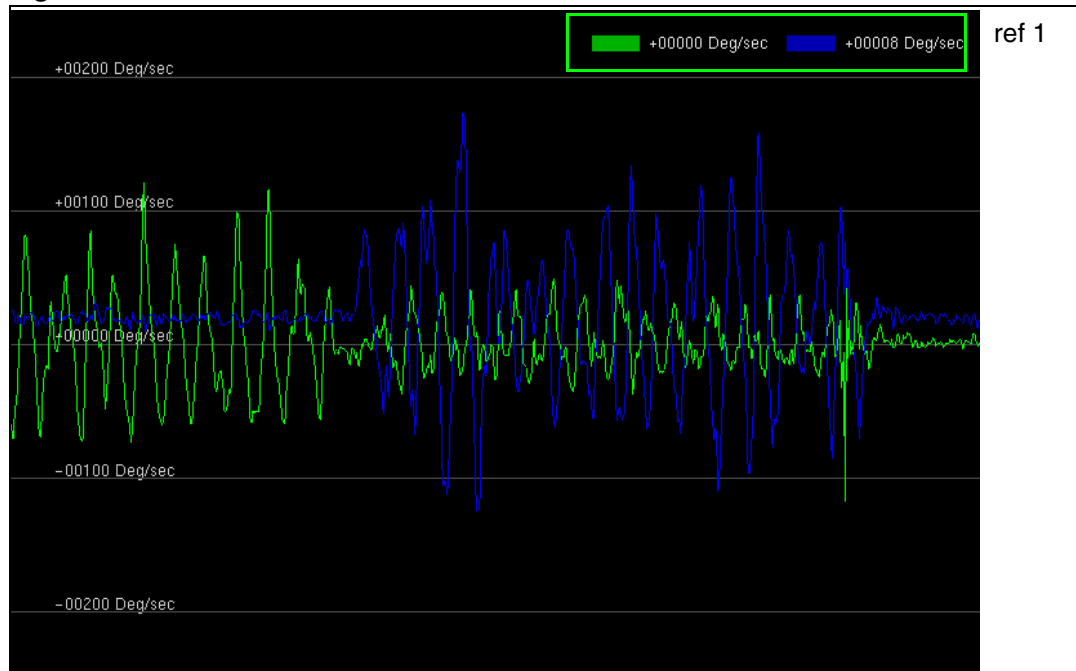
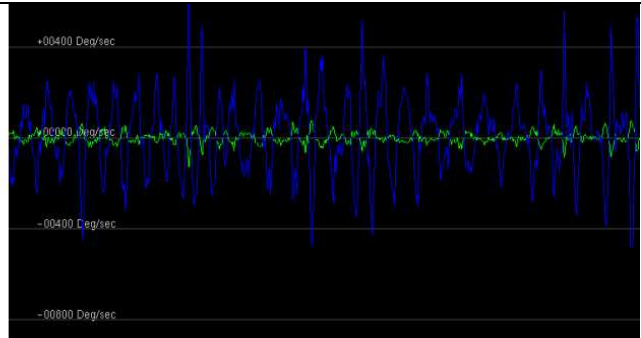
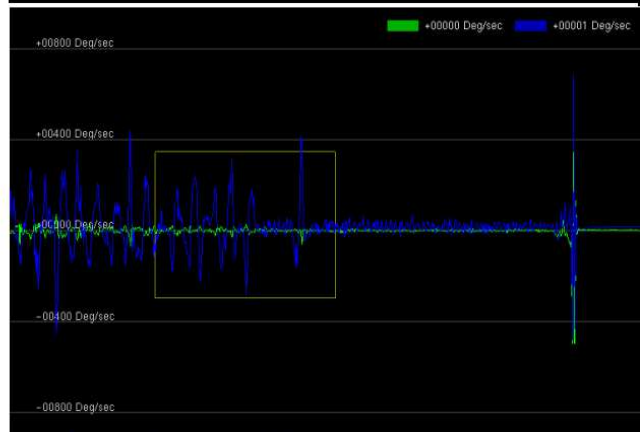

Figure 14. Plot tab - zoom

1) Select one point on the screen and click the LEFT mouse button.



2) Holding the LEFT mouse button pressed, move the cursor to select an area on the screen.



3) Releasing the LEFT mouse button to terminate the zoom in process, a new magnified area is shown on the screen.

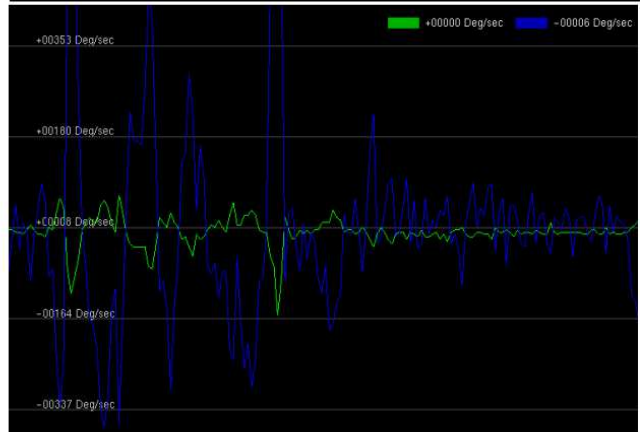

4) To return to the original view, click the RIGHT mouse button.

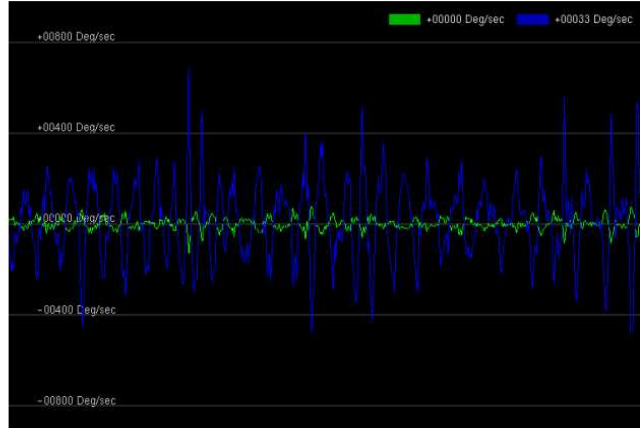

4.2.6 “Data” tab

The data tab (*Figure 15*) shows the angular rate values measured by the device. It is divided into two sections:

1. “ADC out” (*Figure 15*, ref 1) - displays the angular rate data provided by the sensor after its conversion to digital format by the 8-bit AD converter
2. “Angular rate value” (*Figure 15*, ref 2) - represents the angular rate data measured by the sensor, converted by the AD converter and multiplied by the currently-selected sensitivity. Values are expressed as deg/sec.

Note: To increase data readability, the values shown in the boxes described above are based on an average of 50 samples.

Figure 15. Data tab

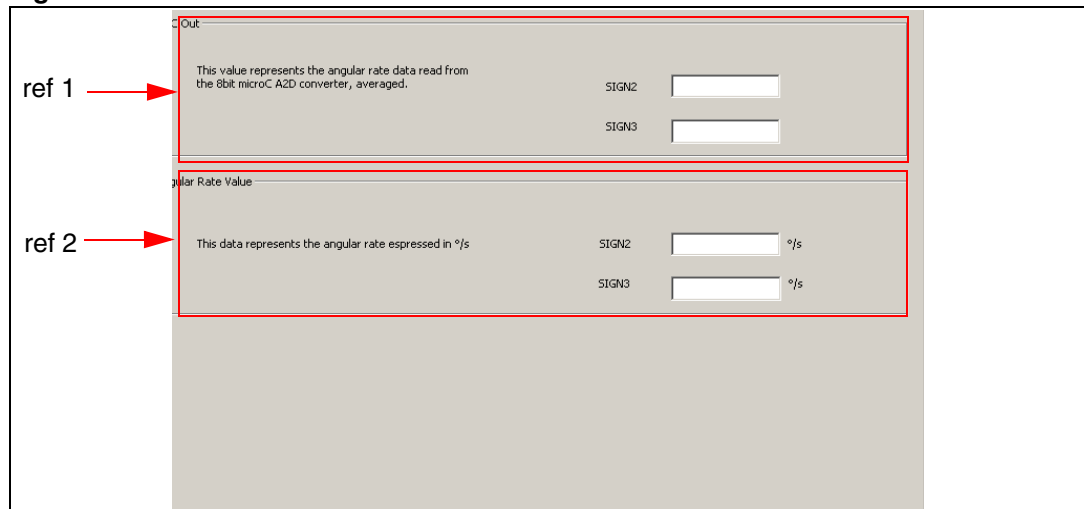

4.2.7 “FFT” tab

The FFT tab (*Figure 16*) shows the FFT of the angular rate signals acquired by the sensor. The spectral data are updated for every sample arrival and are calculated on a 64-sample moving window.

Figure 16. FFT tab

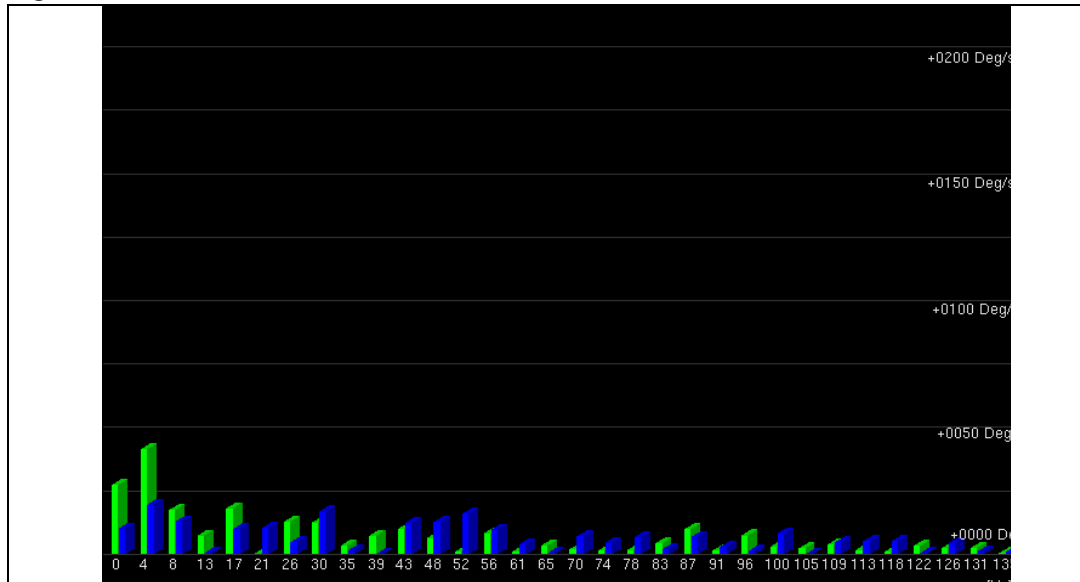

5 Data acquisition quick start

This section describes the basic steps that must be performed to acquire the yaw data from the STEVAL-MKI0xxV1:

1. Connect the STEVAL-MKI0xxV1 to the USB port.
2. Start the STEVAL-MKI0xxV1 GUI.
3. Select the virtual COM port and click on the “Connect” button (*Figure 9*, ref 1).
4. Select the destination file to which the yaw data must be saved by clicking “Save” (*Figure 9*, ref 2) in the main control section (optional).
5. Use the tab menu to display the desired function.
6. Click on the “START” (or “STOP”) button to activate (or stop) the sensor data collection, saving to file, and screen plotting functions.
7. To close the application, click on “Disconnect” and then click on “Exit”.

6 STEVAL-MKI0xxV1 Lite

A lite version of the GUI together with its source code is also included in the installation pack. The source code can be found in the directory: (\$Home)\STM\STEVAL-MKI0xxV1\STEVAL-MKI0xxV1_lite, where (\$Home) is the directory in which the software that came with the demonstration kit was installed (C:\Program Files by default).

The purpose of the lite version is to provide the user with a foundation for the development of a customized application.

The lite version of the demonstration kit is started by launching the STEVAL-MKI0xxV1 Lite executable file located in the STEVAL-MKI0xxV1 > Executables folder.

An example of the GUI of the STEVAL-MKI0xxV1 Lite application is shown in [Figure 17](#).

Figure 17. STEVAL-MKI0xxV1 Lite GUI

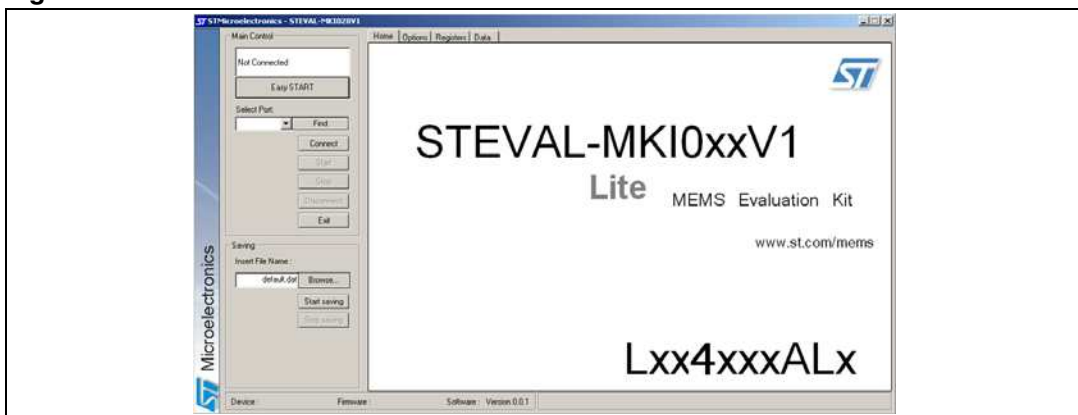

Follow these instructions to use the software:

1. Connect the STEVAL-MKI0xxV1 to the USB port.
2. Launch the GUI for STEVAL-MKI0xxV1 Lite.
3. Select the virtual COM port and click on the “Connect” button.
4. Select the destination file to which the yaw rate data must be saved (optional).
5. Click on the “START” (or “STOP”) button to activate (or stop) the sensor data collection, saving to file, and screen plotting functions.
6. To close the application, click on “Disconnect” and then click on “Exit”.

7 Supported commands

The microcontroller mounted on the STEVAL-MKI0xxV1 board is equipped with dedicated firmware which supports a set of commands that allow control of the single axis digital output MEMS sensor and permit the acquisition of the measured angular rate data. The firmware also handles the communication between the STEVAL-MKI0xxV1 and the PC through the USB bus. These features allow users to easily write their own applications to exploit the capabilities of the gyroscope.

This section describes the commands that are supported by the firmware for the microcontroller of the STEVAL-MKI0xxV1 demonstration kit.

7.1 Getting started

Before using the commands supported by the firmware, the following procedure must be performed:

1. Connect the STEVAL-MKI0xxV1 to the USB port.
2. Launch an application that allows the sending of commands through the virtual serial port. The remainder of this document assumes the use of Microsoft's Hyper Terminal program, available with the Windows XP operating system.
3. Create a new connection, enter a name (ex. "STEVAL-MKI0xxV1"), and click "OK".
4. In the "Connect Using" field, select the virtual COM port to which the USB port has been mapped, and click "OK".
5. In port settings, set bits per second to 115200, data bits to 8, parity to none, stop bits to 1, and flow control to none. Click "OK".
6. In the "Hyper Terminal" application window choose "files" > "properties" > "settings", then click on the "ASCII Setup" button.
7. Select "Send line ends with line feeds" and "Echo typed characters locally".
8. Click the "OK" button to close the "ASCII Setup" window.
9. Click the "OK" button to close the "Properties" window.

Once this procedure has been completed the user can utilize the commands described in the following sections by typing them into the Hyper Terminal window.

7.2 Supported commands

The table below lists the commands supported by the STEVAL-MKI0xxV1 firmware.

Some commands are valid only for DCWM. Using them outside of DCWM could result in unexpected errors.

Table 5. Supported commands

| Command | Description | Returned value | Available in WM |
|---------|---|------------------------------|-----------------|
| *start | Starts continuous data acquisition | s t R 4O2 O2 4O1 O1 oh S | DC |
| *debug | Returns the angular rate data in readable text format | 4*[OUTX=XXXXX] VREF=XXXXX | DC |