



Chipsmall Limited consists of a professional team with an average of over 10 year of expertise in the distribution of electronic components. Based in Hongkong, we have already established firm and mutual-benefit business relationships with customers from,Europe,America and south Asia,supplying obsolete and hard-to-find components to meet their specific needs.

With the principle of “Quality Parts,Customers Priority,Honest Operation,and Considerate Service”,our business mainly focus on the distribution of electronic components. Line cards we deal with include Microchip,ALPS,ROHM,Xilinx,Pulse,ON,Everlight and Freescale. Main products comprise IC,Modules,Potentiometer,IC Socket,Relay,Connector.Our parts cover such applications as commercial,industrial, and automotives areas.

We are looking forward to setting up business relationship with you and hope to provide you with the best service and solution. Let us make a better world for our industry!



Contact us

Tel: +86-755-8981 8866 Fax: +86-755-8427 6832

Email & Skype: info@chipsmall.com Web: www.chipsmall.com

Address: A1208, Overseas Decoration Building, #122 Zhenhua RD., Futian, Shenzhen, China





STGB8NC60KD - STGD8NC60KD STGF8NC60KD - STGP8NC60KD

600 V - 8 A - short circuit rugged IGBT

Features

- Lower on voltage drop ($V_{CE(sat)}$)
- Lower C_{RES} / C_{IES} ratio (no cross-conduction susceptibility)
- Very soft ultra fast recovery antiparallel diode
- Short circuit withstand time 10 μ s

Applications

- High frequency motor controls
- SMPS and PFC in both hard switch and resonant topologies
- Motor drivers

Description

This IGBT utilizes the advanced PowerMESH™ process resulting in an excellent trade-off between switching performance and low on-state behavior.

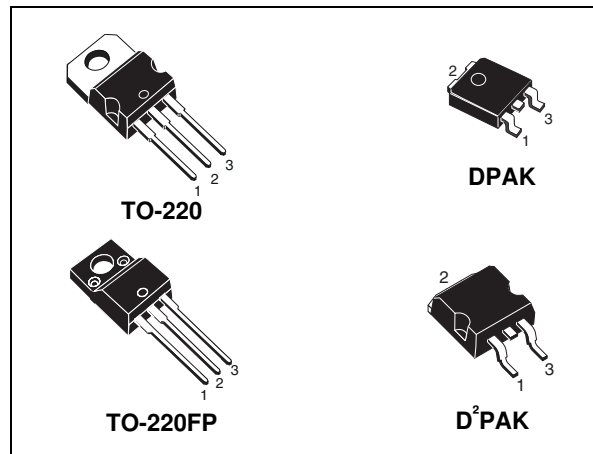

Figure 1. Internal schematic diagram

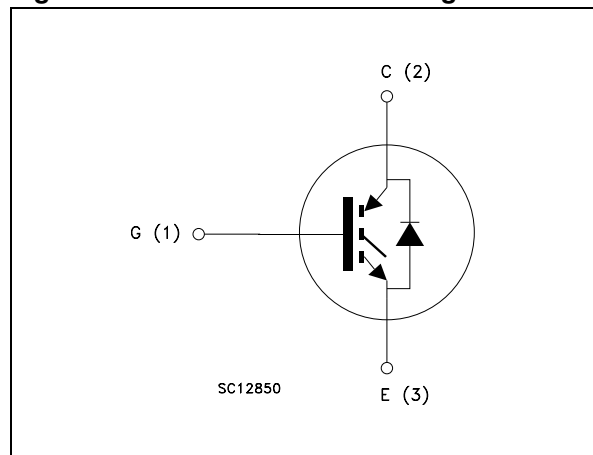

Table 1. Device summary

Order codes	Marking	Package	Packaging
STGB8NC60KDT4	GB8NC60KD	D ² PAK	Tape and reel
STGD8NC60KDT4	GD8NC60KD	DPAK	Tape and reel
STGF8NC60KD	GF8NC60KD	TO-220FP	Tube
STGP8NC60KD	GP8NC60KD	TO-220	Tube

Contents

1	Electrical ratings	3
2	Electrical characteristics	4
	2.1 Electrical characteristics (curves)	7
3	Test circuit	10
4	Package mechanical data	11
5	Packaging mechanical data	15
6	Revision history	17

1 Electrical ratings

Table 2. Absolute maximum ratings

Symbol	Parameter	Value			Unit
		D ² PAK TO-220	DPAK	TO-220FP	
V _{CES}	Collector-emitter voltage (V _{GE} = 0)	600			V
I _C ⁽¹⁾	Collector current (continuous) at T _C = 25 °C	15		7	A
I _C ⁽¹⁾	Collector current (continuous) at T _C = 100 °C	8		4	A
I _{CL} ⁽²⁾	Turn-off latching current	30			A
I _{CP} ⁽³⁾	Pulsed collector current	30			A
V _{GE}	Gate-emitter voltage	±20			V
I _F	Diode RMS forward current at T _C = 25 °C	7			A
I _{FSM}	Surge not repetitive forward current t _p = 10 ms sinusoidal	20			A
V _{ISO}	Insulation withstand voltage (RMS) from all three leads to external heat sink (t = 1 s; T _C = 25 °C)	--	--	2500	V
P _{TOT}	Total dissipation at T _C = 25 °C	65	62	24	W
T _j	Operating junction temperature	- 55 to 150			°C
T _{scw}	Short circuit withstand time (V _{CE} = 0.5 V _{BR(CES)} , T _C = 125 °C, R _G = 10 Ω, V _{GE} = 12 V)	10			μs

1. Calculated according to the iterative formula:

$$I_C(T_C) = \frac{T_{JMAX} - T_C}{R_{THJ-C} \times V_{CESAT(MAX)}(T_C) \cdot I_C}$$

- V_{clamp} = 80% (V_{CES}), V_{GE} = 15 V, R_G = 10 Ω, T_J = 150 °C
- Pulse width limited by max junction temperature allowed

Table 3. Thermal resistance

Symbol	Parameter	Value			Unit
		D ² PAK TO-220	DPAK	TO-220FP	
R _{thj-case}	Thermal resistance junction-case max IGBT	1.9	2.0	5.1	°C/W
R _{thj-case}	Thermal resistance junction-case max diode	4	4.5	7	°C/W
R _{thj-amb}	Thermal resistance junction-ambient max	62.5			°C/W

2 Electrical characteristics

($T_{CASE}=25^{\circ}\text{C}$ unless otherwise specified)

Table 4. Static

Symbol	Parameter	Test conditions	Min.	Typ.	Max.	Unit
$V_{(BR)CES}$	Collector-emitter breakdown voltage ($V_{GE}=0$)	$I_C=1\text{ mA}$	600			V
$V_{CE(sat)}$	Collector-emitter saturation voltage	$V_{GE}=15\text{ V}$, $I_C=3\text{ A}$ $V_{GE}=15\text{ V}$, $I_C=3\text{ A}$, $T_C=125^{\circ}\text{C}$		2.2 1.8	2.75	V V
$V_{GE(th)}$	Gate threshold voltage	$V_{CE}=V_{GE}$, $I_C=250\text{ }\mu\text{A}$	4.5		6.5	V
I_{CES}	Collector cut-off current ($V_{GE}=0$)	$V_{CE}=600\text{ V}$ $V_{CE}=600\text{ V}$, $T_C=125^{\circ}\text{C}$			150 1	μA mA
I_{GES}	Gate-emitter leakage current ($V_{CE}=0$)	$V_{GE}=\pm 20\text{ V}$			± 100	nA
$g_{fs}^{(1)}$	Forward transconductance	$V_{CE}=15\text{ V}$, $I_C=3\text{ A}$		1.9		S

1. Pulse duration = 300 us, duty cycle 1.5 %

Table 5. Dynamic

Symbol	Parameter	Test conditions	Min.	Typ.	Max.	Unit
C_{ies}	Input capacitance	$V_{CE}=25\text{ V}$, $f=1\text{ MHz}$, $V_{GE}=0$		380		pF
C_{oes}	Output capacitance			46		pF
C_{res}	Reverse transfer capacitance			8.5		pF
Q_g	Total gate charge	$V_{CE}=390\text{ V}$, $I_C=3\text{ A}$,		19		nC
Q_{ge}	Gate-emitter charge	$V_{GE}=15\text{ V}$,		5		nC
Q_{gc}	Gate-collector charge	(see Figure 20)		9		nC

Table 6. Switching on/off (inductive load)

Symbol	Parameter	Test conditions	Min.	Typ.	Max.	Unit
$t_{d(on)}$	Turn-on delay time	$V_{CC}=390\text{ V}$, $I_C=3\text{ A}$ $R_G=10\text{ }\Omega$, $V_{GE}=15\text{ V}$ (see Figure 21)		17		ns
t_r	Current rise time			6		ns
$(di/dt)_{on}$	Turn-on current slope				655	
$t_{d(on)}$	Turn-on delay time	$V_{CC}=390\text{ V}$, $I_C=3\text{ A}$ $R_G=10\text{ }\Omega$, $V_{GE}=15\text{ V}$, $T_C=125^{\circ}\text{C}$ (see Figure 21)		16.5		ns
t_r	Current rise time			6.5		ns
$(di/dt)_{on}$	Turn-on current slope				575	

Table 6. Switching on/off (inductive load) (continued)

Symbol	Parameter	Test conditions	Min.	Typ.	Max.	Unit
$t_r(V_{off})$	Off voltage rise time	$V_{CC} = 390\text{ V}, I_C = 3\text{ A},$		33		ns
$t_{d(off)}$	Turn-off delay time	$R_{GE} = 10\ \Omega, V_{GE} = 15\text{ V}$		72		ns
t_f	Current fall time	(see Figure 21)		82		ns
$t_r(V_{off})$	Off voltage rise time	$V_{CC} = 390\text{ V}, I_C = 3\text{ A},$		60		ns
$t_{d(off)}$	Turn-off delay time	$R_{GE} = 10\ \Omega, V_{GE} = 15\text{ V},$		106		ns
t_f	Current fall time	$T_C = 125\text{ }^\circ\text{C}$ (see Figure 21)		136		ns

Table 7. Switching energy (inductive load)

Symbol	Parameter	Test conditions	Min.	Typ.	Max.	Unit
$E_{on}^{(1)}$	Turn-on switching losses	$V_{CC} = 390\text{ V}, I_C = 3\text{ A}$		55		μJ
$E_{off}^{(2)}$	Turn-off switching losses	$R_G = 10\ \Omega, V_{GE} = 15\text{ V}$		85		μJ
E_{ts}	Total switching losses	(see Figure 21)		140		μJ
$E_{on}^{(1)}$	Turn-on switching losses	$V_{CC} = 390\text{ V}, I_C = 3\text{ A}$		87		μJ
$E_{off}^{(2)}$	Turn-off switching losses	$R_G = 10\ \Omega, V_{GE} = 15\text{ V},$		162		μJ
E_{ts}	Total switching losses	$T_C = 125\text{ }^\circ\text{C}$ (see Figure 21)		249		μJ

1. E_{on} is the turn-on losses when a typical diode is used in the test circuit in figure 2. If the IGBT is offered in a package with a co-pak diode, the co-pak diode is used as external diode. IGBTs & Diode are at the same temperature (25°C and 125°C)
2. Turn-off losses include also the tail of the collector current

Table 8. Collector-emitter diode

Symbol	Parameter	Test conditions	Min.	Typ.	Max.	Unit
V_F	Forward on-voltage	$I_F = 3\text{ A}$ $I_F = 3\text{ A}, T_C = 125\text{ }^\circ\text{C}$		1.6 1.3	2.1	V V
t_{rr}	Reverse recovery time	$I_F = 3\text{ A}, V_R = 30\text{ V},$		23.5		ns
Q_{rr}	Reverse recovery charge	$di/dt = 100\text{ A}/\mu\text{s}$		16.5		nC
I_{rrm}	Reverse recovery current	(see Figure 22)		1.4		A
t_{rr}	Reverse recovery time	$I_F = 3\text{ A}, V_R = 30\text{ V},$		39		ns
Q_{rr}	Reverse recovery charge	$T_C = 125\text{ }^\circ\text{C}, di/dt = 100\text{ A}/\mu\text{s}$		39		nC
I_{rrm}	Reverse recovery current	(see Figure 22)		2		A

2.1 Electrical characteristics (curves)

Figure 2. Output characteristics

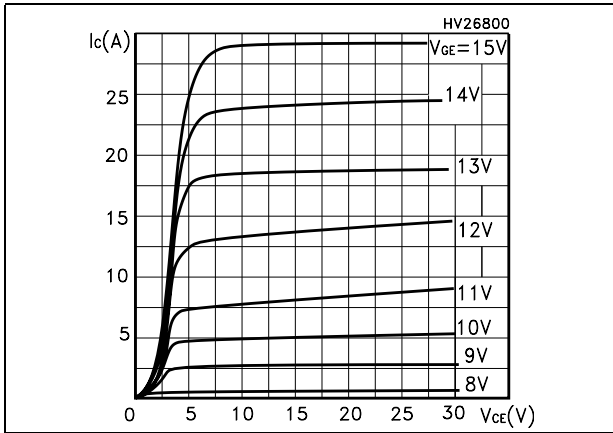

Figure 3. Transfer characteristics

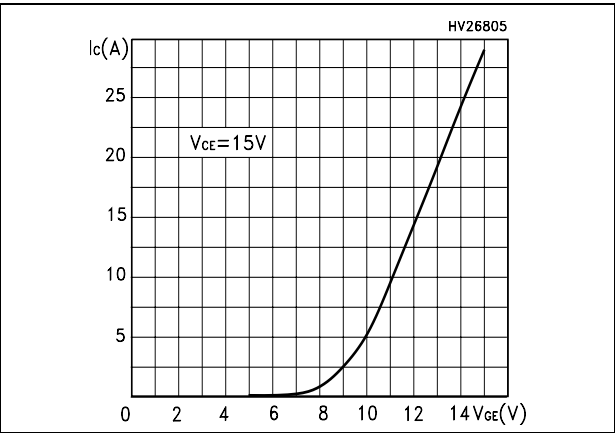

Figure 4. Transconductance

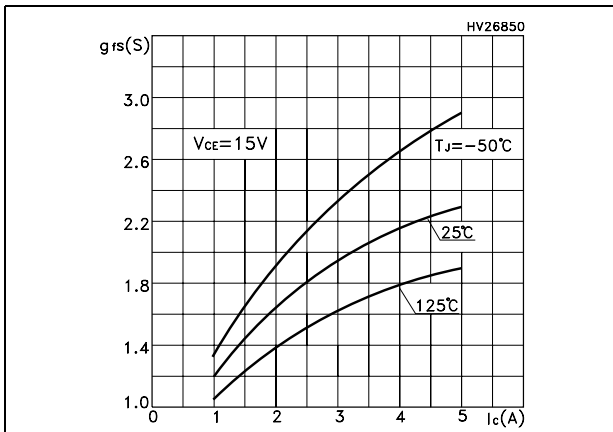

Figure 5. Collector-emitter on voltage vs temperature

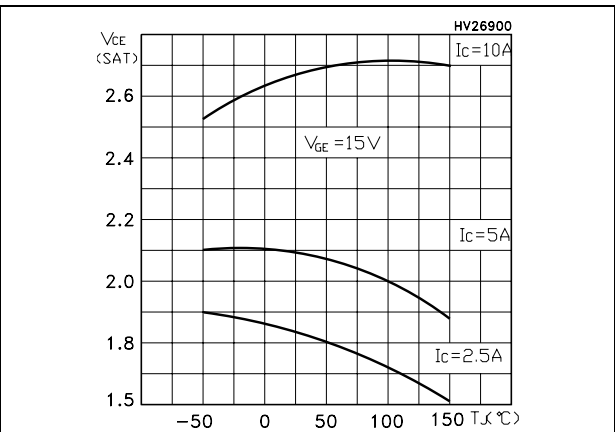

Figure 6. Gate charge vs gate-source voltage

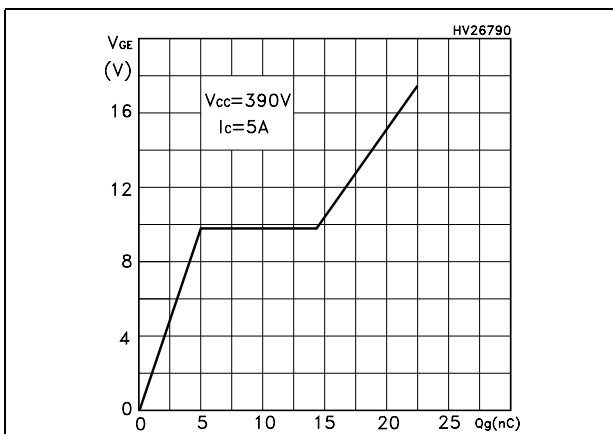

Figure 7. Capacitance variations

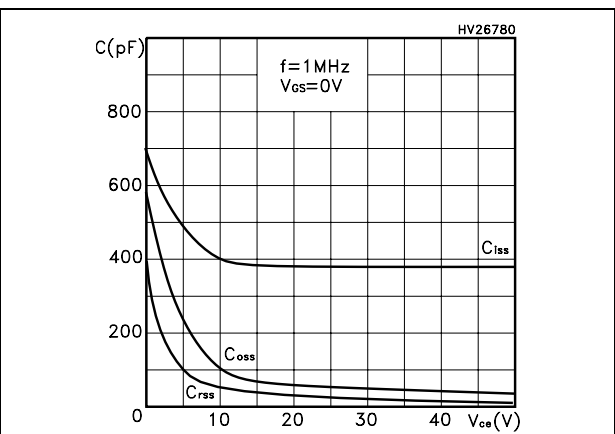

Figure 8. Normalized gate threshold voltage vs temperature

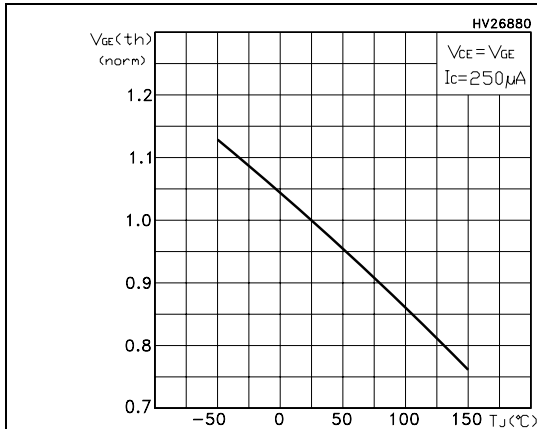

Figure 9. Collector-emitter on voltage vs collector current

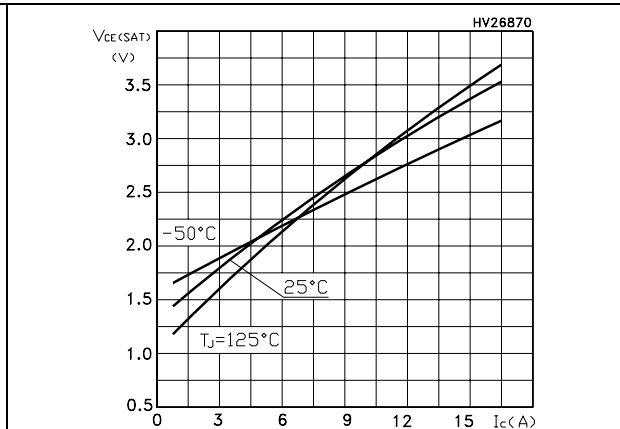

Figure 10. Normalized breakdown voltage vs temperature

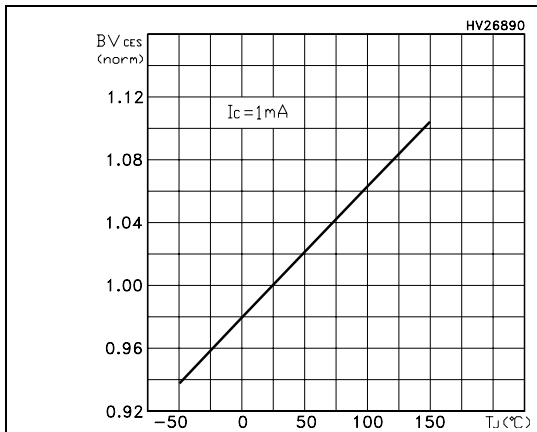

Figure 11. Switching losses vs temperature

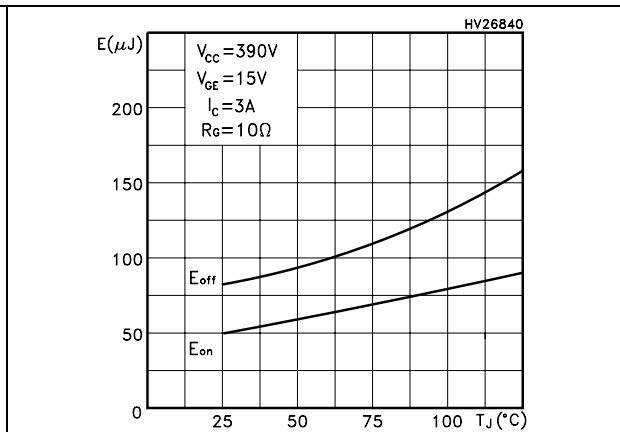

Figure 12. Switching losses vs gate resistance

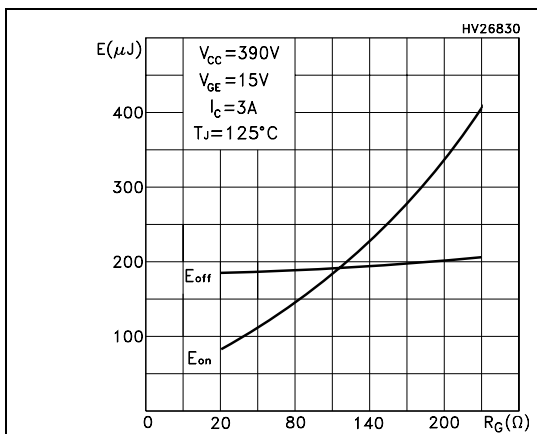

Figure 13. Switching losses vs collector current

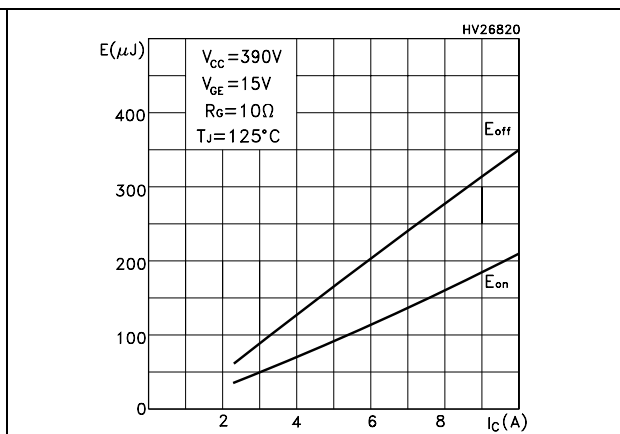

Figure 14. Thermal impedance for TO-220/D²PAK

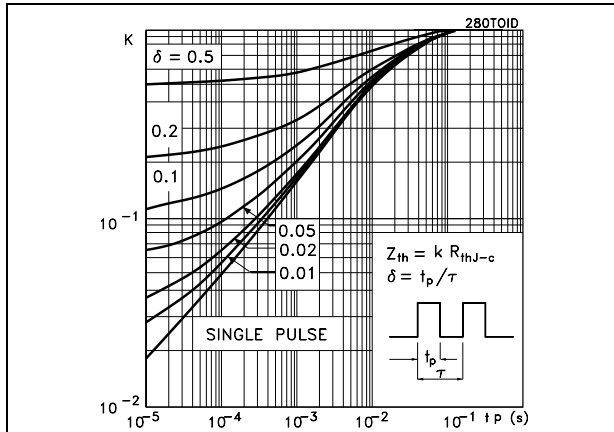

Figure 15. Turn-off SOA

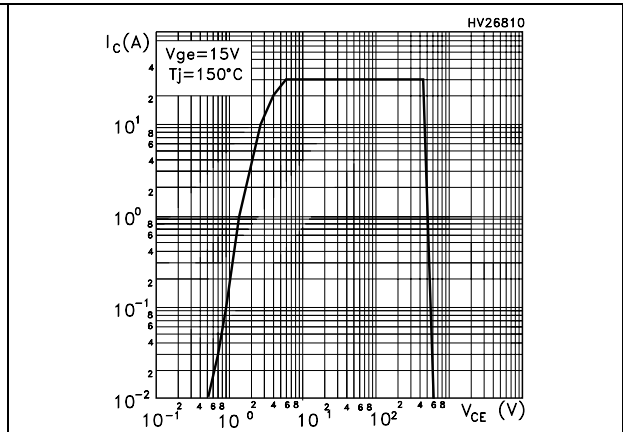

Figure 16. Forward voltage drop versus forward current

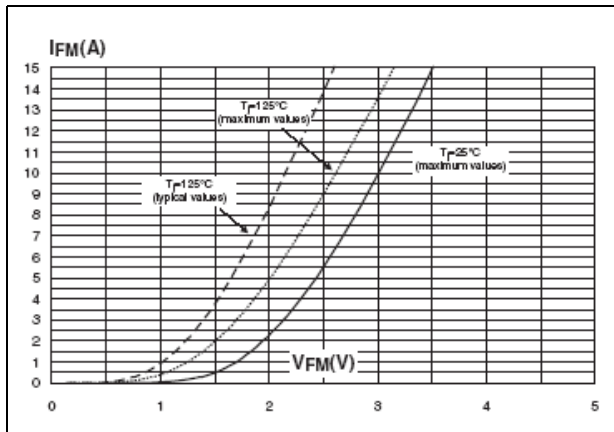

Figure 17. Thermal impedance for DPAK

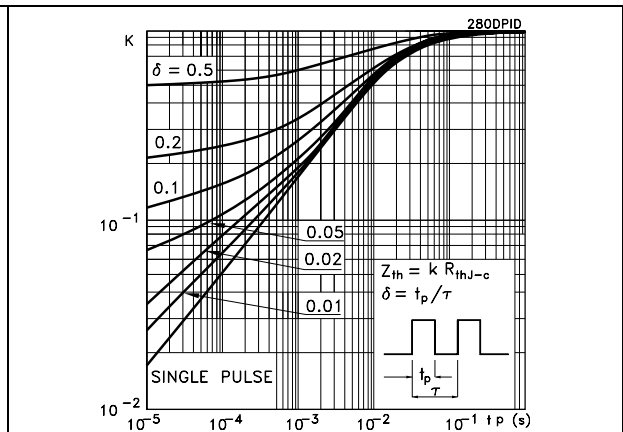
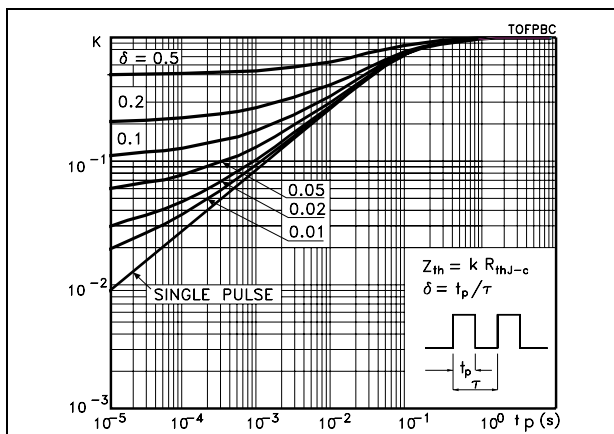

Figure 18. Thermal impedance for TO-220FP



3 Test circuit

Figure 19. Test circuit for inductive load switching

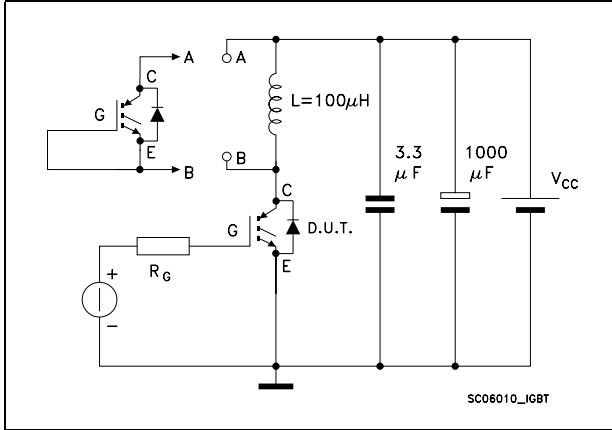

Figure 20. Gate charge test circuit

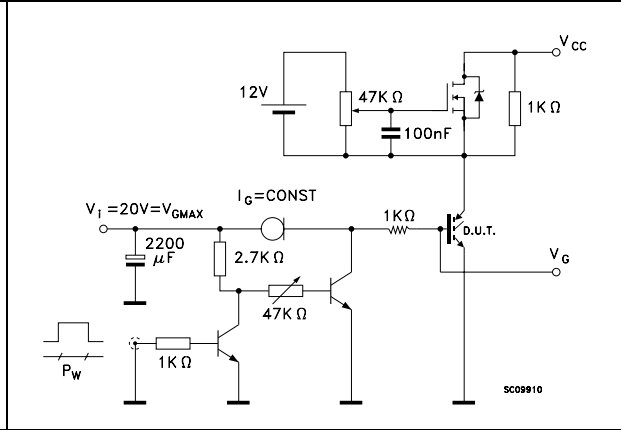

Figure 21. Switching waveform

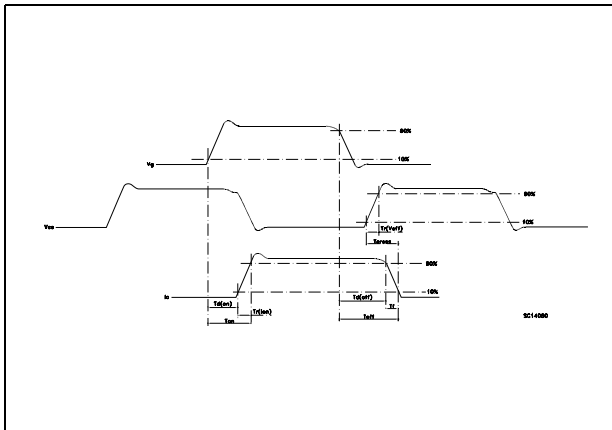
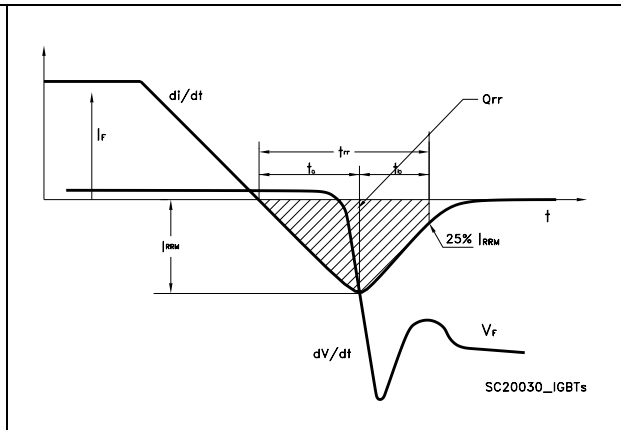

Figure 22. Diode recovery time waveform



4 **Package mechanical data**

In order to meet environmental requirements, ST offers these devices in ECOPACK® packages. These packages have a lead-free second level interconnect. The category of second level interconnect is marked on the package and on the inner box label, in compliance with JEDEC Standard JESD97. The maximum ratings related to soldering conditions are also marked on the inner box label. ECOPACK is an ST trademark. ECOPACK specifications are available at: www.st.com

TO-220 mechanical data

Dim	mm			inch		
	Min	Typ	Max	Min	Typ	Max
A	4.40		4.60	0.173		0.181
b	0.61		0.88	0.024		0.034
b1	1.14		1.70	0.044		0.066
c	0.48		0.70	0.019		0.027
D	15.25		15.75	0.6		0.62
D1		1.27			0.050	
E	10		10.40	0.393		0.409
e	2.40		2.70	0.094		0.106
e1	4.95		5.15	0.194		0.202
F	1.23		1.32	0.048		0.051
H1	6.20		6.60	0.244		0.256
J1	2.40		2.72	0.094		0.107
L	13		14	0.511		0.551
L1	3.50		3.93	0.137		0.154
L20		16.40			0.645	
L30		28.90			1.137	
∅P	3.75		3.85	0.147		0.151
Q	2.65		2.95	0.104		0.116

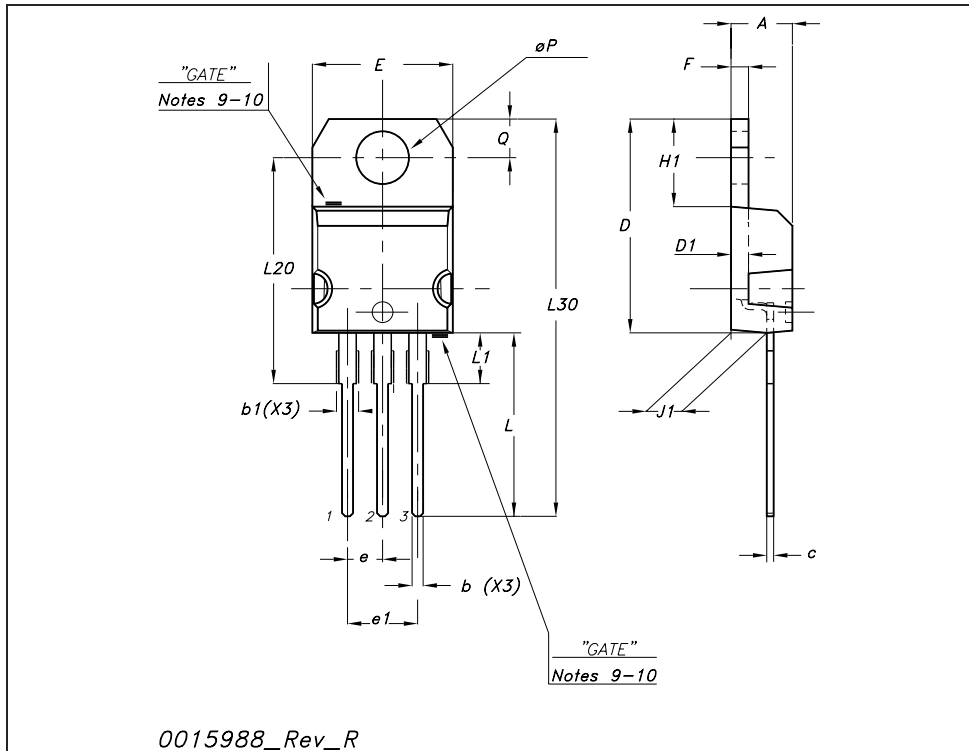

TO-252 (DPAK) mechanical data

DIM.	mm.		
	min.	typ	max.
A	2.20		2.40
A1	0.90		1.10
A2	0.03		0.23
b	0.64		0.90
b4	5.20		5.40
c	0.45		0.60
c2	0.48		0.60
D	6.00		6.20
D1		5.10	
E	6.40		6.60
E1		4.70	
e		2.28	
e1	4.40		4.60
H	9.35		10.10
L	1		
L1		2.80	
L2		0.80	
L4	0.60		1
R		0.20	
V2	0°		8°

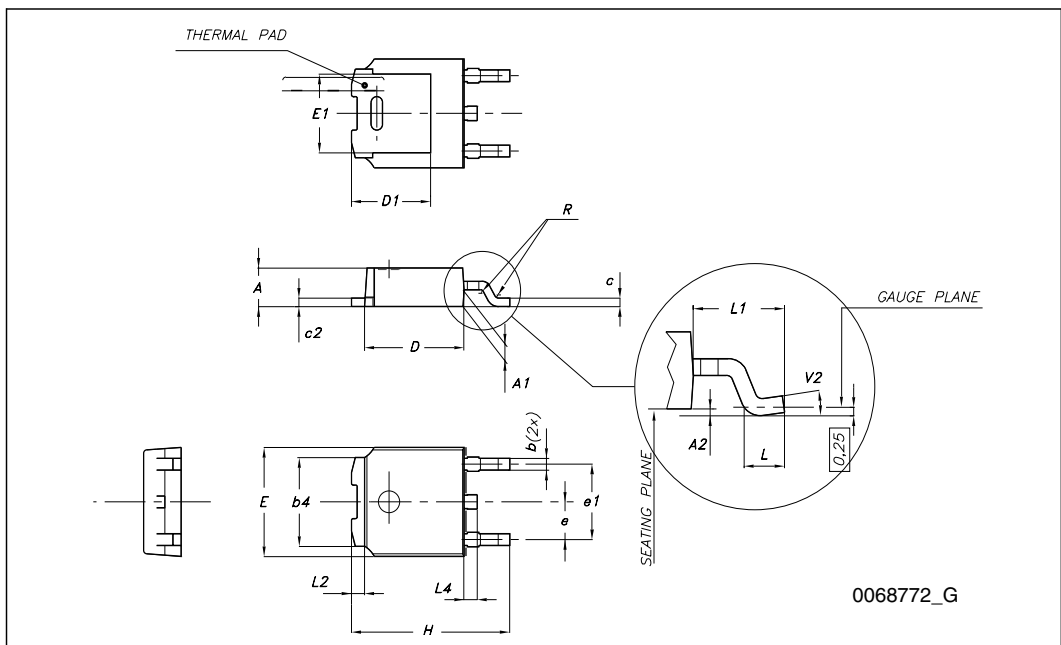

D²PAK (TO-263) mechanical data

Dim	mm			inch		
	Min	Typ	Max	Min	Typ	Max
A	4.40		4.60	0.173		0.181
A1	0.03		0.23	0.001		0.009
b	0.70		0.93	0.027		0.037
b2	1.14		1.70	0.045		0.067
c	0.45		0.60	0.017		0.024
c2	1.23		1.36	0.048		0.053
D	8.95		9.35	0.352		0.368
D1	7.50			0.295		
E	10		10.40	0.394		0.409
E1	8.50			0.334		
e		2.54			0.1	
e1	4.88		5.28	0.192		0.208
H	15		15.85	0.590		0.624
J1	2.49		2.69	0.099		0.106
L	2.29		2.79	0.090		0.110
L1	1.27		1.40	0.05		0.055
L2	1.30		1.75	0.051		0.069
R		0.4			0.016	
V2	0°		8°	0°		8°

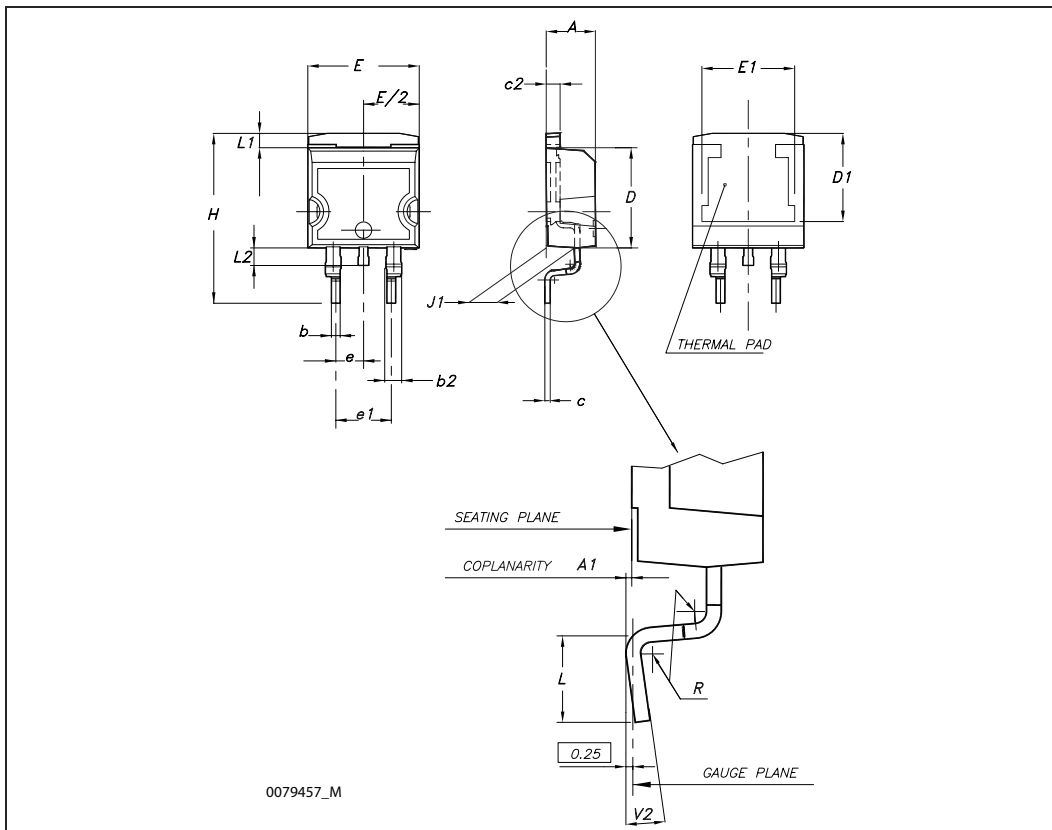

TO-220FP mechanical data

Dim.	mm.			inch		
	Min.	Typ	Max.	Min.	Typ.	Max.
A	4.40		4.60	0.173		0.181
B	2.5		2.7	0.098		0.106
D	2.5		2.75	0.098		0.108
E	0.45		0.70	0.017		0.027
F	0.75		1.00	0.030		0.039
F1	1.15		1.50	0.045		0.067
F2	1.15		1.50	0.045		0.067
G	4.95		5.20	0.195		0.204
G1	2.40		2.70	0.094		0.106
H	10		10.40	0.393		0.409
L2		16			0.630	
L3	28.6		30.6	1.126		1.204
L4	9.80		10.60	0.385		0.417
L5	2.9		3.6	0.114		0.141
L6	15.90		16.40	0.626		0.645
L7	9		9.30	0.354		0.366
Dia	3		3.2	0.118		0.126

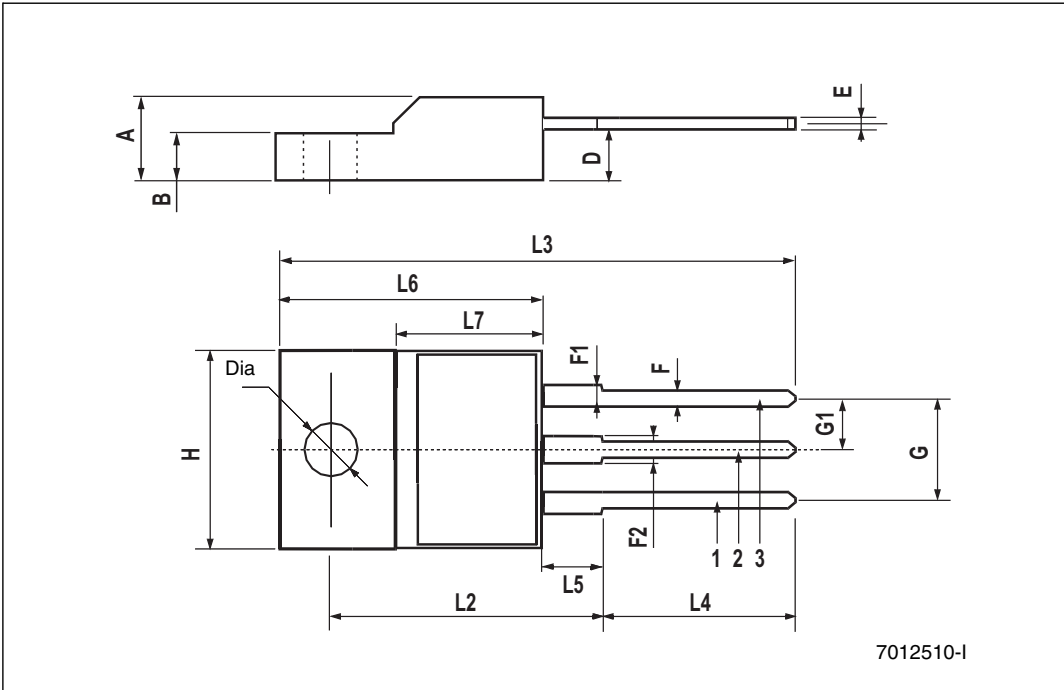

5 Packaging mechanical data

D²PAK FOOTPRINT

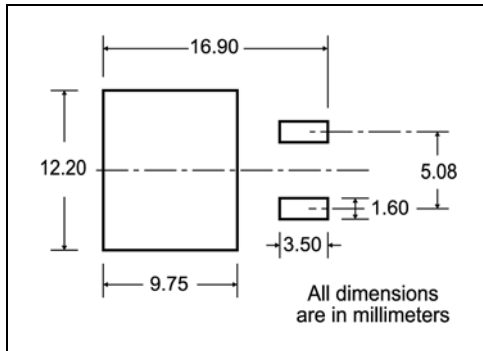

TAPE AND REEL SHIPMENT

TAPE MECHANICAL DATA

DIM.	mm		inch	
	MIN.	MAX.	MIN.	MAX.
A0	10.5	10.7	0.413	0.421
B0	15.7	15.9	0.618	0.626
D	1.5	1.6	0.059	0.063
D1	1.59	1.61	0.062	0.063
E	1.65	1.85	0.065	0.073
F	11.4	11.6	0.449	0.456
K0	4.8	5.0	0.189	0.197
P0	3.9	4.1	0.153	0.161
P1	11.9	12.1	0.468	0.476
P2	1.9	2.1	0.075	0.082
R	50		1.574	
T	0.25	0.35	0.0098	0.0137
W	23.7	24.3	0.933	0.956

REEL MECHANICAL DATA

DIM.	mm		inch	
	MIN.	MAX.	MIN.	MAX.
A		330		12.992
B	1.5		0.059	
C	12.8	13.2	0.504	0.520
D	20.2		0.795	
G	24.4	26.4	0.960	1.039
N	100		3.937	
T		30.4		1.197

BASE QTY	BULK QTY
1000	1000

10 pitches cumulative tolerance on tape +/- 0.2 mm

Center line of cavity

User Direction of Feed

FEED DIRECTION

TRL

Bending radius R min.

* on sales type

DPAK FOOTPRINT

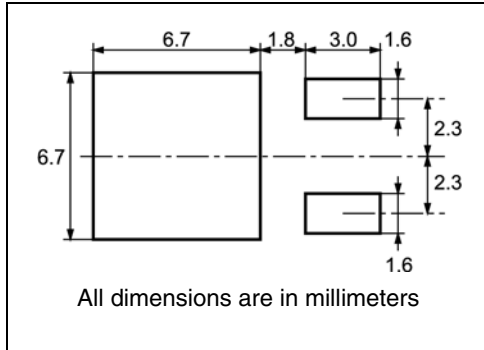

TAPE AND REEL SHIPMENT

40 mm min. Access hole at slot location

Full radius

Tape slot in core for tape start 2.5mm min. width

G measured at hub

REEL MECHANICAL DATA

DIM.	mm		inch	
	MIN.	MAX.	MIN.	MAX.
A		330		12.992
B	1.5		0.059	
C	12.8	13.2	0.504	0.520
D	20.2		0.795	
G	16.4	18.4	0.645	0.724
N	50		1.968	
T		22.4		0.881

TAPE MECHANICAL DATA

DIM.	mm		inch	
	MIN.	MAX.	MIN.	MAX.
A0	6.8	7	0.267	0.275
B0	10.4	10.6	0.409	0.417
B1		12.1		0.476
D	1.5	1.6	0.059	0.063
D1	1.5		0.059	
E	1.65	1.85	0.065	0.073
F	7.4	7.6	0.291	0.299
K0	2.55	2.75	0.100	0.108
P0	3.9	4.1	0.153	0.161
P1	7.9	8.1	0.311	0.319
P2	1.9	2.1	0.075	0.082
R	40		1.574	
W	15.7	16.3	0.618	0.641

BASE QTY | **BULK QTY**

2500 | 2500

10 pitches cumulative tolerance on tape +/- 0.2 mm

Center line of cavity

User Direction of Feed

FEED DIRECTION

Bending radius

R min.

For machine ref. only including draft and radii concentric around B0

6 Revision history

Table 9. Document revision history

Date	Revision	Changes
02-Oct-2007	1	First release
01-Apr-2008	2	Updated Figure 14 and Figure 17

Please Read Carefully:

Information in this document is provided solely in connection with ST products. STMicroelectronics NV and its subsidiaries ("ST") reserve the right to make changes, corrections, modifications or improvements, to this document, and the products and services described herein at any time, without notice.

All ST products are sold pursuant to ST's terms and conditions of sale.

Purchasers are solely responsible for the choice, selection and use of the ST products and services described herein, and ST assumes no liability whatsoever relating to the choice, selection or use of the ST products and services described herein.

No license, express or implied, by estoppel or otherwise, to any intellectual property rights is granted under this document. If any part of this document refers to any third party products or services it shall not be deemed a license grant by ST for the use of such third party products or services, or any intellectual property contained therein or considered as a warranty covering the use in any manner whatsoever of such third party products or services or any intellectual property contained therein.

UNLESS OTHERWISE SET FORTH IN ST'S TERMS AND CONDITIONS OF SALE ST DISCLAIMS ANY EXPRESS OR IMPLIED WARRANTY WITH RESPECT TO THE USE AND/OR SALE OF ST PRODUCTS INCLUDING WITHOUT LIMITATION IMPLIED WARRANTIES OF MERCHANTABILITY, FITNESS FOR A PARTICULAR PURPOSE (AND THEIR EQUIVALENTS UNDER THE LAWS OF ANY JURISDICTION), OR INFRINGEMENT OF ANY PATENT, COPYRIGHT OR OTHER INTELLECTUAL PROPERTY RIGHT.

UNLESS EXPRESSLY APPROVED IN WRITING BY AN AUTHORIZED ST REPRESENTATIVE, ST PRODUCTS ARE NOT RECOMMENDED, AUTHORIZED OR WARRANTED FOR USE IN MILITARY, AIR CRAFT, SPACE, LIFE SAVING, OR LIFE SUSTAINING APPLICATIONS, NOR IN PRODUCTS OR SYSTEMS WHERE FAILURE OR MALFUNCTION MAY RESULT IN PERSONAL INJURY, DEATH, OR SEVERE PROPERTY OR ENVIRONMENTAL DAMAGE. ST PRODUCTS WHICH ARE NOT SPECIFIED AS "AUTOMOTIVE GRADE" MAY ONLY BE USED IN AUTOMOTIVE APPLICATIONS AT USER'S OWN RISK.

Resale of ST products with provisions different from the statements and/or technical features set forth in this document shall immediately void any warranty granted by ST for the ST product or service described herein and shall not create or extend in any manner whatsoever, any liability of ST.

ST and the ST logo are trademarks or registered trademarks of ST in various countries.

Information in this document supersedes and replaces all information previously supplied.

The ST logo is a registered trademark of STMicroelectronics. All other names are the property of their respective owners.

© 2008 STMicroelectronics - All rights reserved

STMicroelectronics group of companies

Australia - Belgium - Brazil - Canada - China - Czech Republic - Finland - France - Germany - Hong Kong - India - Israel - Italy - Japan - Malaysia - Malta - Morocco - Singapore - Spain - Sweden - Switzerland - United Kingdom - United States of America

www.st.com