



Chipsmall Limited consists of a professional team with an average of over 10 year of expertise in the distribution of electronic components. Based in Hongkong, we have already established firm and mutual-benefit business relationships with customers from,Europe,America and south Asia,supplying obsolete and hard-to-find components to meet their specific needs.

With the principle of “Quality Parts,Customers Priority,Honest Operation,and Considerate Service”,our business mainly focus on the distribution of electronic components. Line cards we deal with include Microchip,ALPS,ROHM,Xilinx,Pulse,ON,Everlight and Freescale. Main products comprise IC,Modules,Potentiometer,IC Socket,Relay,Connector.Our parts cover such applications as commercial,industrial, and automotives areas.

We are looking forward to setting up business relationship with you and hope to provide you with the best service and solution. Let us make a better world for our industry!



Contact us

Tel: +86-755-8981 8866 Fax: +86-755-8427 6832

Email & Skype: info@chipsmall.com Web: www.chipsmall.com

Address: A1208, Overseas Decoration Building, #122 Zhenhua RD., Futian, Shenzhen, China



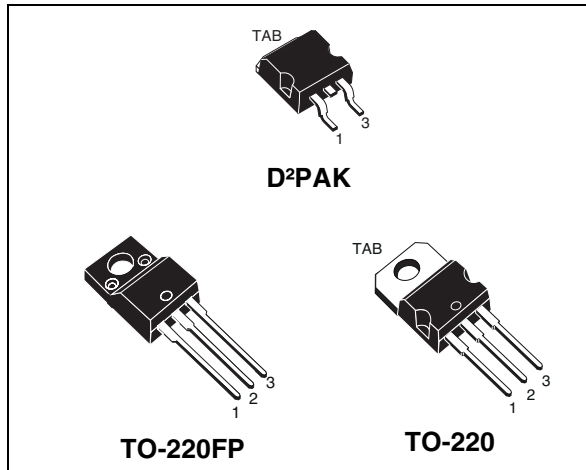
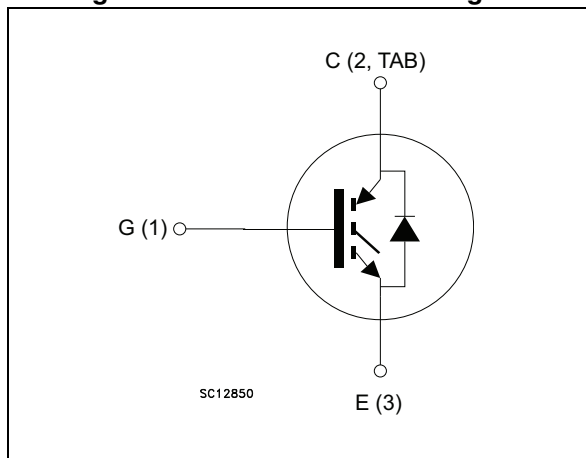

Figure 1. Internal schematic diagram



Features

- High speed switching
- Tight parameters distribution
- Safe paralleling
- Low thermal resistance
- Short-circuit rated
- Ultrafast soft recovery antiparallel diode

Applications

- Motor control
- UPS, PFC

Description

This device is an IGBT developed using an advanced proprietary trench gate and field stop structure. This IGBT series offers the optimum compromise between conduction and switching losses, maximizing the efficiency of very high frequency converters. Furthermore, a positive $V_{CE(sat)}$ temperature coefficient and very tight parameter distribution result in easier paralleling operation.

Table 1. Device summary

Order codes	Marking	Packages	Packaging
STGB15H60DF	GB15H60DF	D ² PAK	Tape and reel
STGF15H60DF	GF15H60DF	TO-220FP	Tube
STGP15H60DF	GP15H60DF	TO-220	Tube

Contents

1	Electrical ratings	3
2	Electrical characteristics	4
2.1	Electrical characteristics (curves)	7
3	Test circuits	13
4	Package mechanical data	14
5	Packaging mechanical data	20
6	Revision history	22



1 Electrical ratings

Table 2. Absolute maximum ratings

Symbol	Parameter	TO-220 D ² PAK	TO-220FP	Unit
V_{CES}	Collector-emitter voltage ($V_{GE} = 0$)	600		V
I_C	Continuous collector current at $T_C = 25\text{ °C}$	30	30 ⁽¹⁾	A
	Continuous collector current at $T_C = 100\text{ °C}$	15	15 ⁽¹⁾	A
$I_{CP}^{(2)}$	Pulsed collector current	60	60 ⁽¹⁾	A
V_{GE}	Gate-emitter voltage	±20		V
I_F	Continuous forward current $T_C = 25\text{ °C}$	30	30 ⁽¹⁾	A
	Continuous forward current at $T_C = 100\text{ °C}$	15	15 ⁽¹⁾	
$I_{FP}^{(2)}$	Pulsed forward current	60	60 ⁽¹⁾	A
P_{TOT}	Total dissipation at $T_C = 25\text{ °C}$	115	30	W
T_{STG}	Storage temperature range	- 55 to 150		°C
T_J	Operating junction temperature	- 55 to 175		

1. Limited by maximum junction temperature.
2. Pulse width limited by maximum junction temperature.

Table 3. Thermal data

Symbol	Parameter	TO-220 D ² PAK	TO-220FP	Unit
R_{thJC}	Thermal resistance junction-case IGBT	1.3	5	°C/W
R_{thJC}	Thermal resistance junction-case diode	2.78	6.25	°C/W
R_{thJA}	Thermal resistance junction-ambient	62.5		°C/W

2 Electrical characteristics

$T_J = 25\text{ °C}$ unless otherwise specified.

Table 4. Static

Symbol	Parameter	Test conditions	Min.	Typ.	Max.	Unit
$V_{(BR)CES}$	Collector-emitter breakdown voltage ($V_{GE} = 0$)	$I_C = 2\text{ mA}$	600			V
$V_{CE(sat)}$	Collector-emitter saturation voltage	$V_{GE} = 15\text{ V}, I_C = 15\text{ A}$		1.6	2.0	V
		$V_{GE} = 15\text{ V}, I_C = 15\text{ A}$ $T_J = 125\text{ °C}$		1.7		
		$V_{GE} = 15\text{ V}, I_C = 15\text{ A}$ $T_J = 175\text{ °C}$		1.8		
$V_{GE(th)}$	Gate threshold voltage	$V_{CE} = V_{GE}, I_C = 1\text{ mA}$	5.0	6.0	7.0	V
I_{CES}	Collector cut-off current ($V_{GE} = 0$)	$V_{CE} = 600\text{ V}$			25	μA
I_{GES}	Gate-emitter leakage current ($V_{CE} = 0$)	$V_{GE} = \pm 20\text{ V}$			250	nA

Table 5. Dynamic

Symbol	Parameter	Test conditions	Min.	Typ.	Max.	Unit
C_{ies}	Input capacitance	$V_{CE} = 25\text{ V}, f = 1\text{ MHz},$ $V_{GE} = 0$	-	1952	-	pF
C_{oes}	Output capacitance		-	78	-	pF
C_{res}	Reverse transfer capacitance		-	45	-	pF
Q_g	Total gate charge	$V_{CC} = 480\text{ V}, I_C = 15\text{ A},$ $V_{GE} = 15\text{ V}$	-	81	-	nC
Q_{ge}	Gate-emitter charge		-	8	-	nC
Q_{gc}	Gate-collector charge		-	42	-	nC

Table 6. Switching characteristics (inductive load)

Symbol	Parameter	Test conditions	Min.	Typ.	Max.	Unit
$t_{d(on)}$	Turn-on delay time	$V_{CE} = 400\text{ V}$, $I_C = 15\text{ A}$, $R_G = 10\ \Omega$, $V_{GE} = 15\text{ V}$		24.5	-	ns
t_r	Current rise time			8.2	-	ns
$(di/dt)_{on}$	Turn-on current slope			1470	-	A/ μ s
$t_{d(on)}$	Turn-on delay time	$V_{CE} = 400\text{ V}$, $I_C = 15\text{ A}$, $R_G = 10\ \Omega$, $V_{GE} = 15\text{ V}$ $T_J = 175\text{ }^\circ\text{C}$		25	-	ns
t_r	Current rise time			9	-	ns
$(di/dt)_{on}$	Turn-on current slope			1370	-	A/ μ s
$t_{r(Voff)}$	Off voltage rise time	$V_{CE} = 400\text{ V}$, $I_C = 15\text{ A}$, $R_G = 10\ \Omega$, $V_{GE} = 15\text{ V}$		18	-	ns
$t_{d(off)}$	Turn-off delay time			118	-	ns
t_f	Current fall time			69	-	ns
$t_{r(Voff)}$	Off voltage rise time	$V_{CE} = 400\text{ V}$, $I_C = 15\text{ A}$, $R_G = 10\ \Omega$, $V_{GE} = 15\text{ V}$ $T_J = 175\text{ }^\circ\text{C}$		27	-	ns
$t_{d(off)}$	Turn-off delay time			124	-	ns
t_f	Current fall time			101	-	ns
t_{sc}	Short-circuit withstand time	$V_{CC} \leq 360\text{ V}$, $V_{GE} = 15\text{ V}$, $R_G = 10\ \Omega$	3	5	-	μ s

Table 7. Switching energy (inductive load)

Symbol	Parameter	Test conditions	Min.	Typ.	Max.	Unit	
$E_{on}^{(1)}$	Turn-on switching losses	$V_{CE} = 400\text{ V}$, $I_C = 15\text{ A}$, $R_G = 10\ \Omega$, $V_{GE} = 15\text{ V}$	-	136	-	μ J	
$E_{off}^{(2)}$	Turn-off switching losses			-	207	-	μ J
E_{ts}	Total switching losses			-	343	-	μ J
$E_{on}^{(1)}$	Turn-on switching losses	$V_{CE} = 400\text{ V}$, $I_C = 15\text{ A}$, $R_G = 10\ \Omega$, $V_{GE} = 15\text{ V}$ $T_J = 175\text{ }^\circ\text{C}$	-	224	-	μ J	
$E_{off}^{(2)}$	Turn-off switching losses			-	329	-	μ J
E_{ts}	Total switching losses			-	553	-	μ J

1. Energy losses include reverse recovery of the diode.
2. Turn-off losses include also the tail of the collector current.

Table 8. Collector-emitter diode

Symbol	Parameter	Test conditions	Min.	Typ.	Max.	Unit		
V_F	Forward on-voltage	$I_F = 15 \text{ A}$ $I_F = 15 \text{ A}, T_J = 175 \text{ }^\circ\text{C}$	-	1.8	2.2	V		
				1.3		V		
t_{rr}	Reverse recovery time	$V_r = 60 \text{ V}; I_F = 15 \text{ A};$ $di_F/dt = 100 \text{ A} / \mu\text{s}$	-	103		ns		
Q_{rr}	Reverse recovery charge		-	128		nC		
I_{rrm}	Reverse recovery current		-	2.5		A		
t_{rr}	Reverse recovery time	$V_r = 60 \text{ V}; I_F = 15 \text{ A};$ $di_F/dt = 100 \text{ A} / \mu\text{s}$ $T_J = 175 \text{ }^\circ\text{C}$	-	182		ns		
			Q_{rr}	Reverse recovery charge	-	437		nC
			I_{rrm}	Reverse recovery current	-	4.8		A

2.1 Electrical characteristics (curves)

Figure 2. Power dissipation vs. case temperature for D²PAK and TO-220

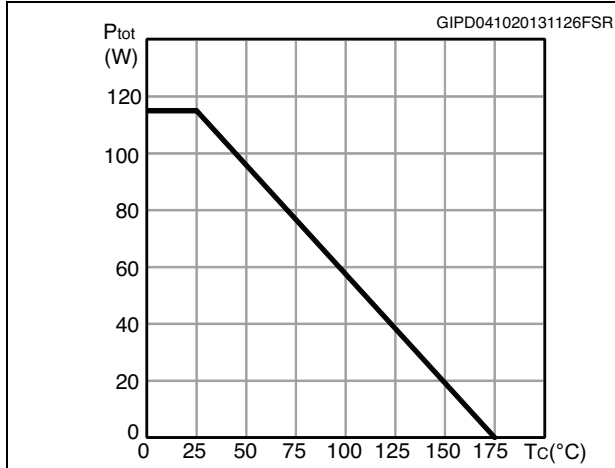

Figure 3. Collector current vs. case temperature for D²PAK and TO-220

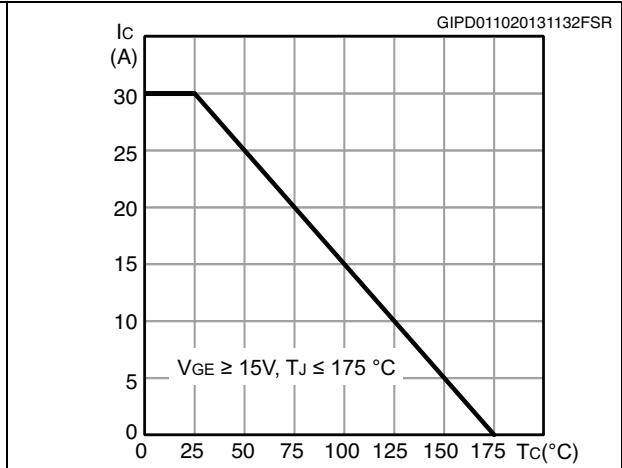

Figure 4. Power dissipation vs. case temperature for TO-220FP

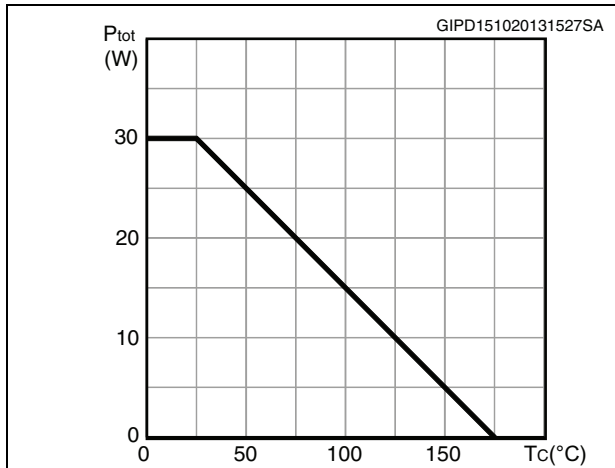

Figure 5. Collector current vs. case temperature for TO-220FP

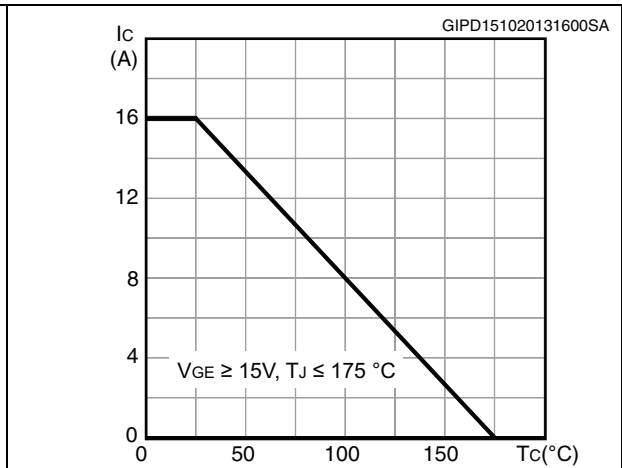

Figure 6. Output characteristics ($T_J = 25^\circ C$)

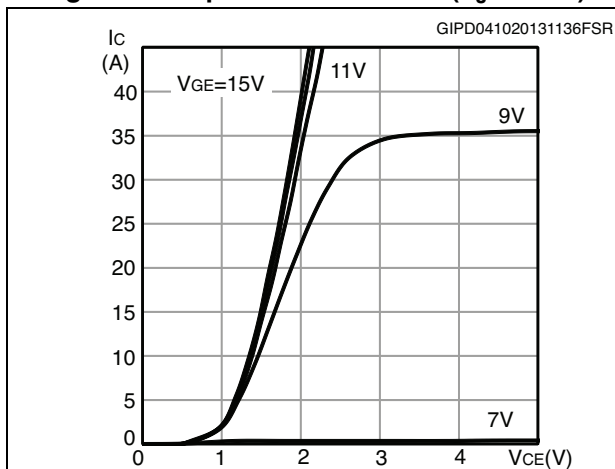

Figure 7. Output characteristics ($T_J = 175^\circ C$)

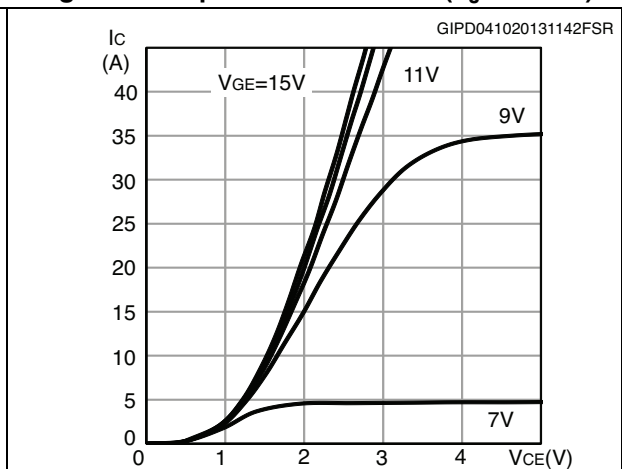

Figure 8. $V_{CE(sat)}$ vs. junction temperature

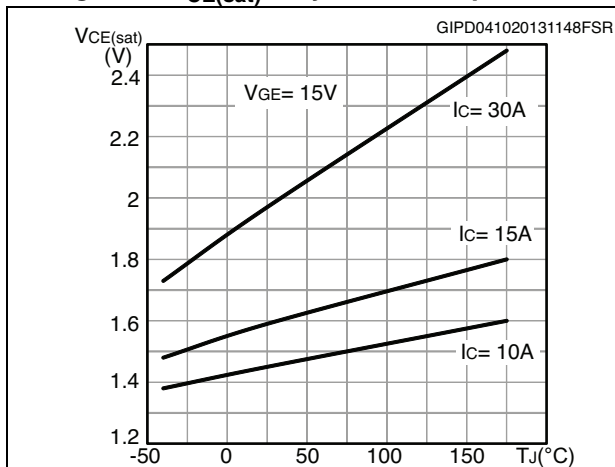

Figure 9. $V_{CE(sat)}$ vs. collector current

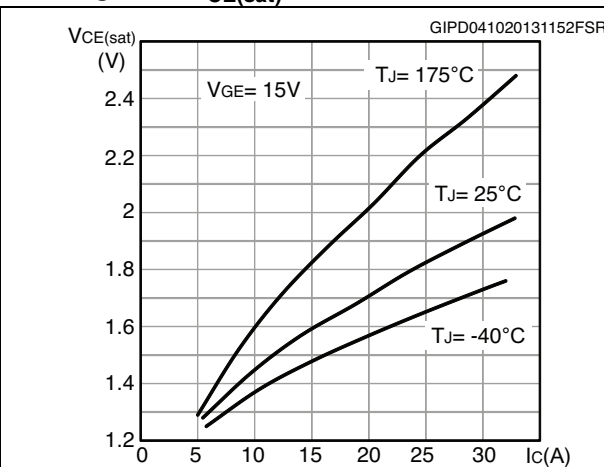

Figure 10. Collector current vs. switching frequency for D²PAK and TO-220

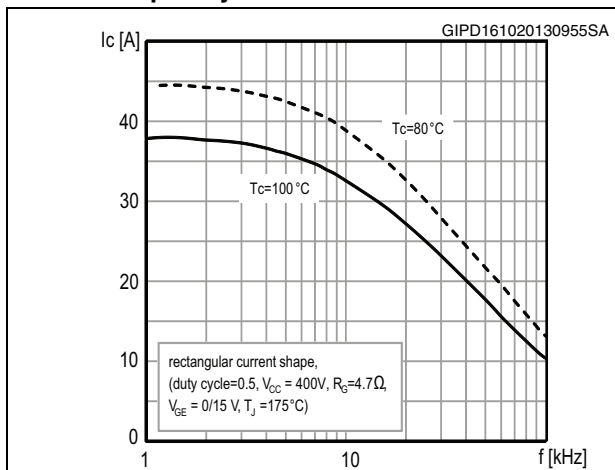

Figure 11. Collector current vs. switching frequency for TO-220FP

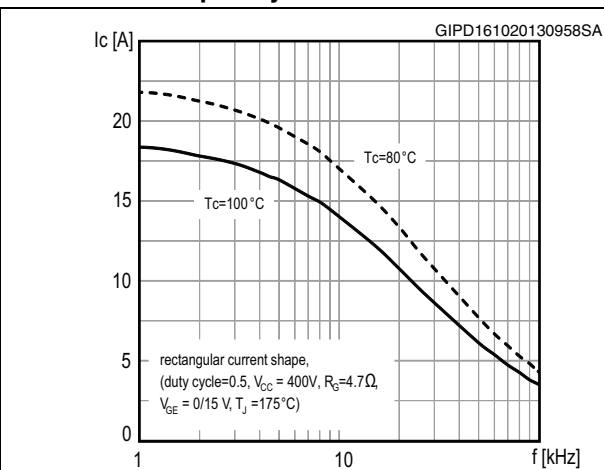

Figure 12. Forward bias safe operating area for D²PAK and TO-220

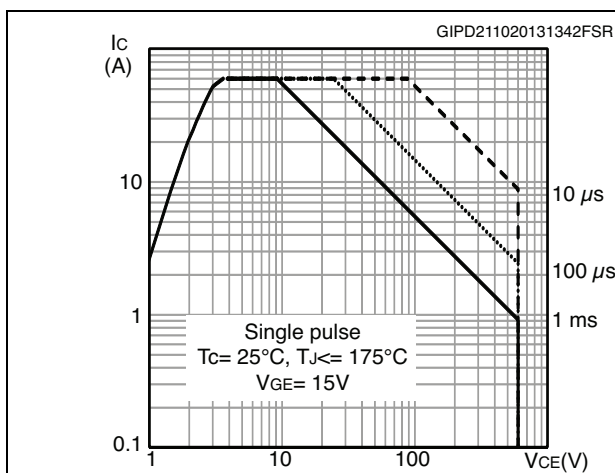

Figure 13. Forward bias safe operating area for TO-220FP

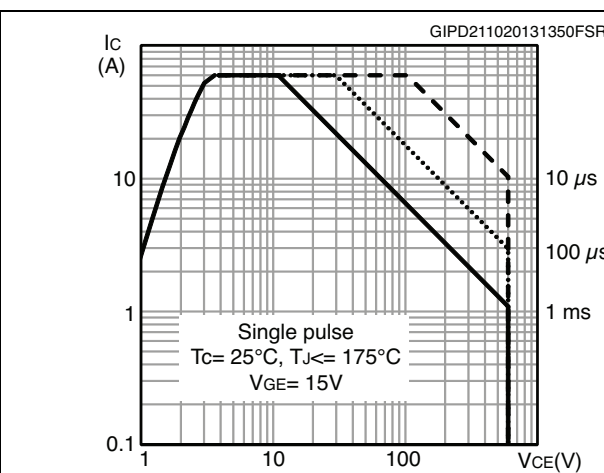

Figure 14. Transfer characteristics

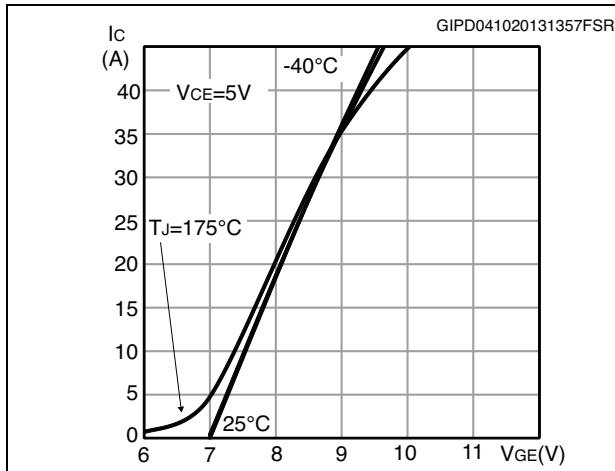

Figure 15. Diode V_F vs. forward current

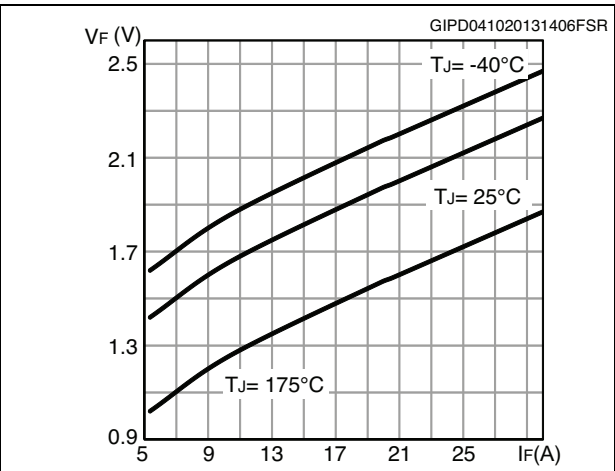

Figure 16. Normalized $V_{GE(th)}$ vs junction temperature

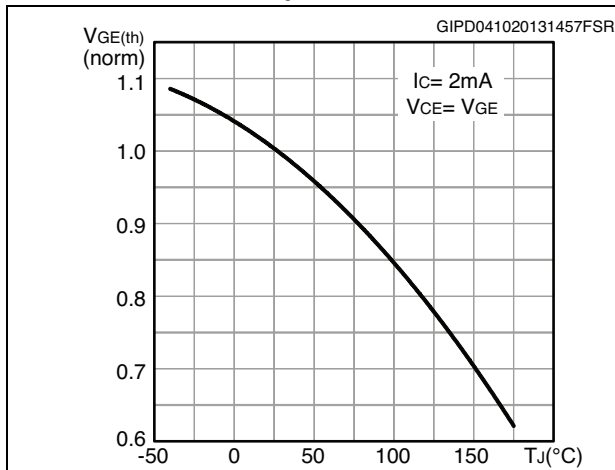

Figure 17. Normalized $V_{(BR)CES}$ vs. junction temperature

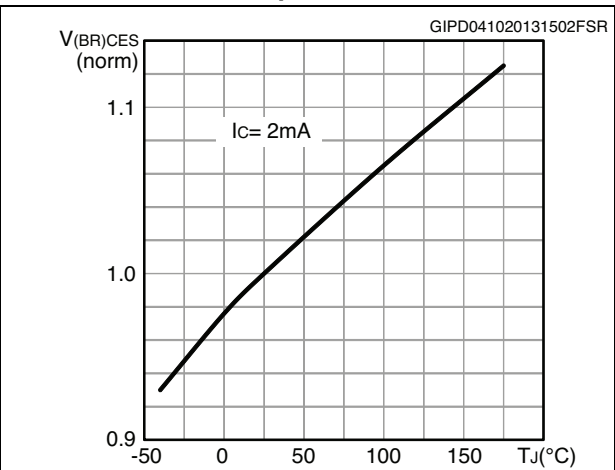

Figure 18. Capacitance variation

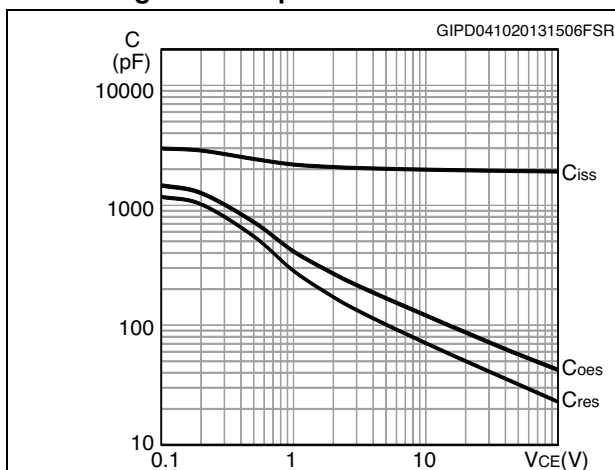

Figure 19. Gate charge vs. gate-emitter voltage

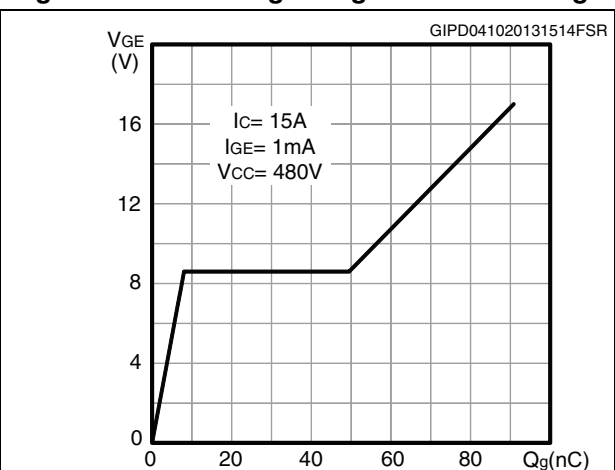

Figure 20. Switching-off loss vs collector current

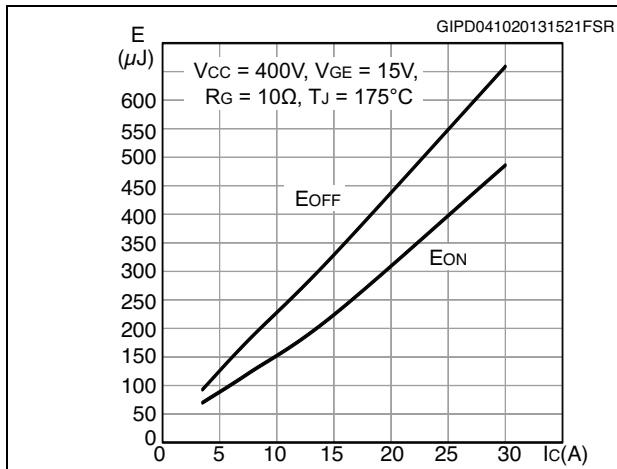

Figure 21. Switching-off loss vs gate resistance

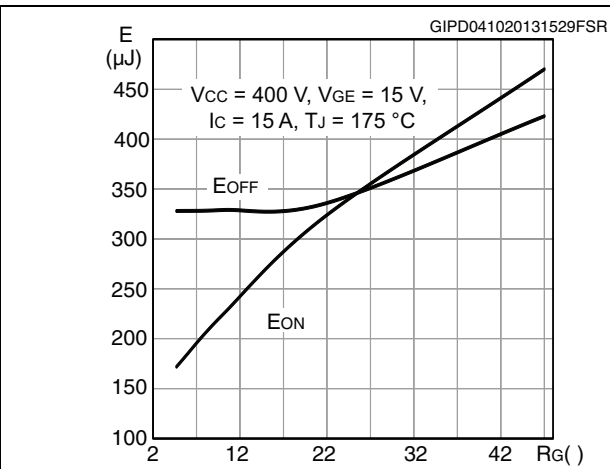

Figure 22. Switching-off loss vs temperature

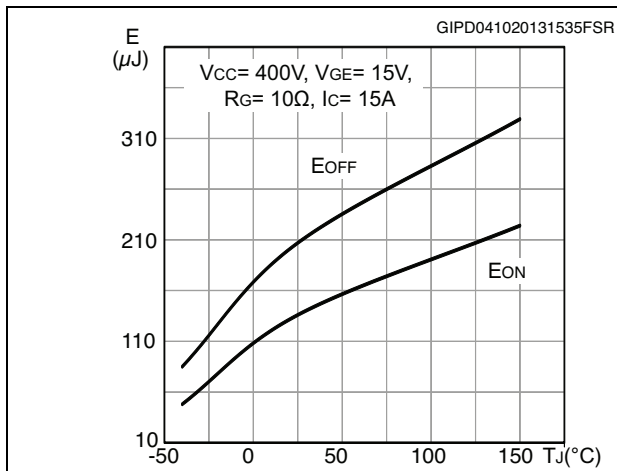

Figure 23. Switching-off loss vs collector-emitter voltage

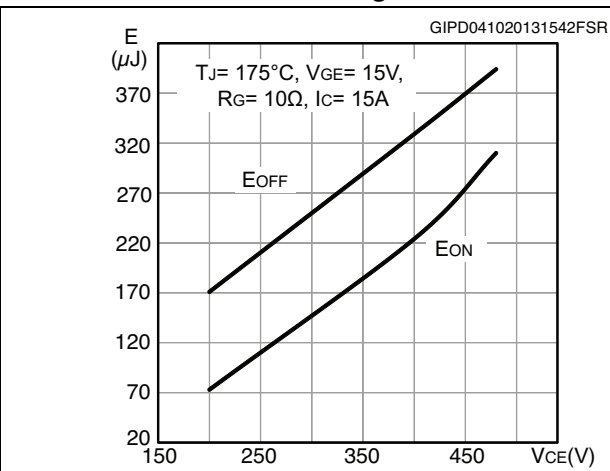

Figure 24. Short circuit time and current vs VGE

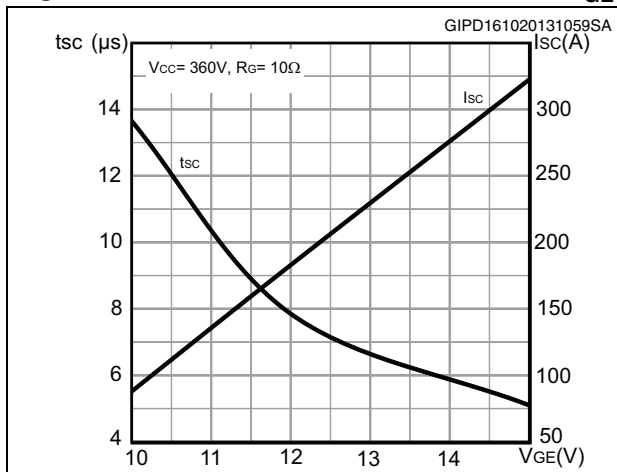

Figure 25. Switching times vs. collector current

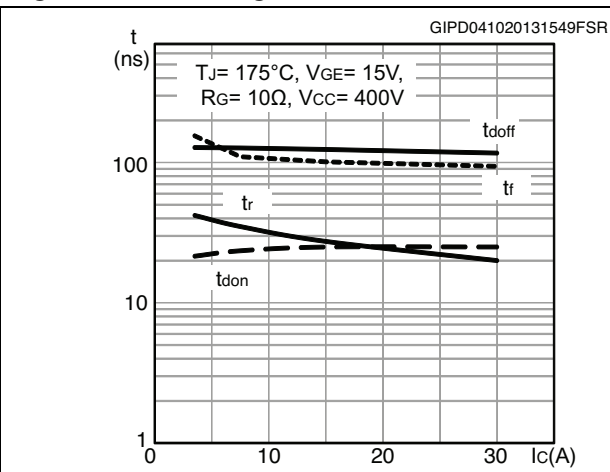

Figure 26. Switching times vs. gate resistance

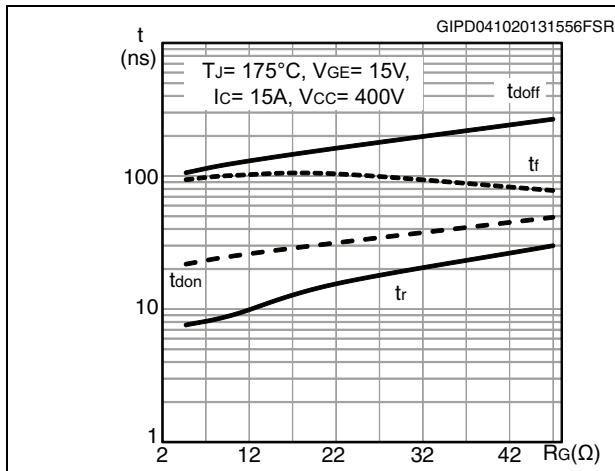

Figure 27. Reverse recovery current vs. diode current slope

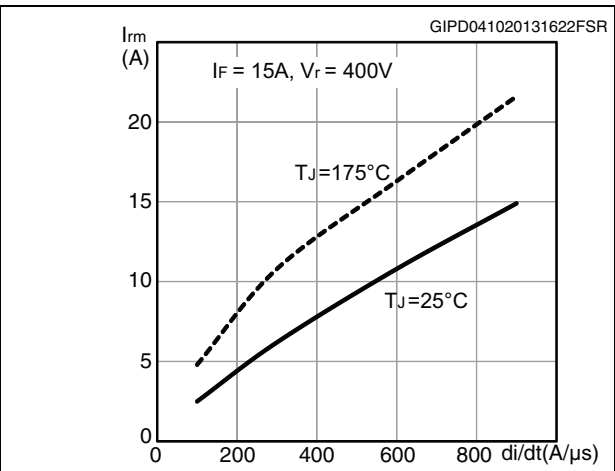

Figure 28. Reverse recovery time vs. diode current slope

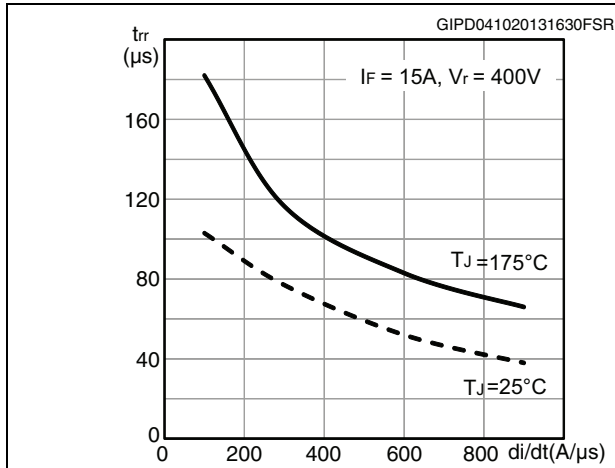

Figure 29. Reverse recovery charge vs. diode current slope

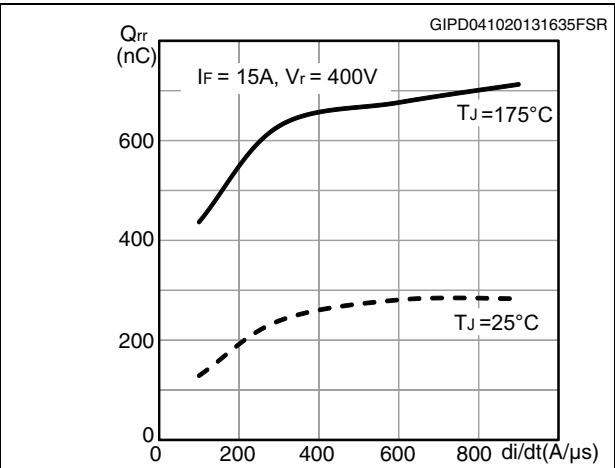

Figure 30. Reverse recovery energy vs. diode current slope

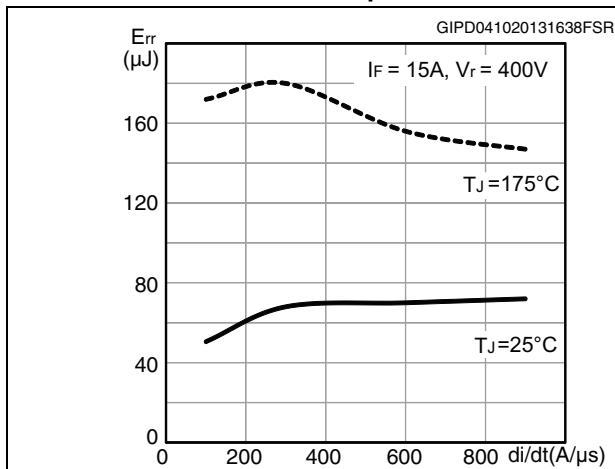

Figure 31. Thermal impedance for IGBT

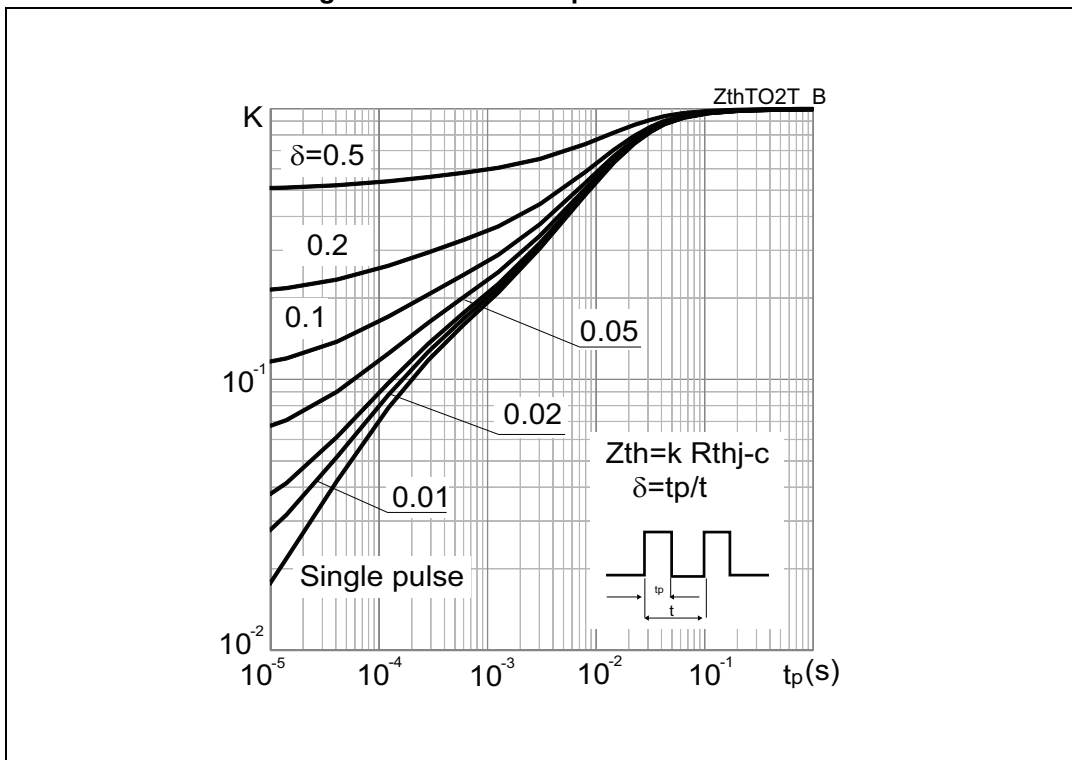
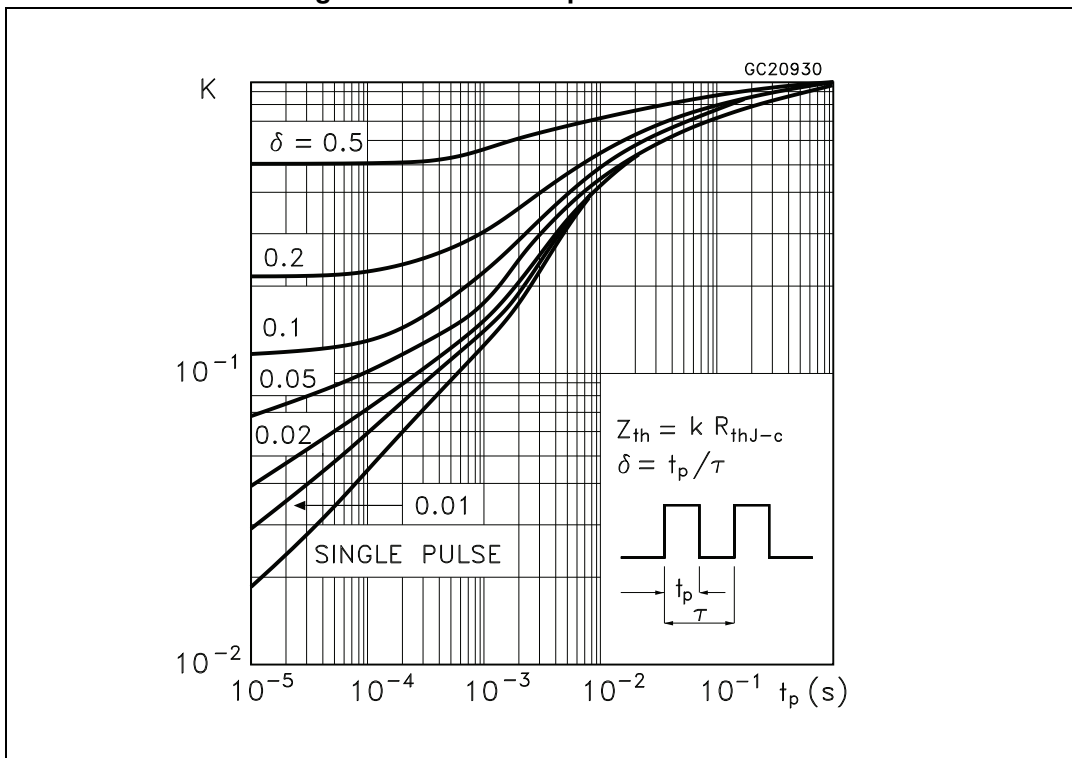
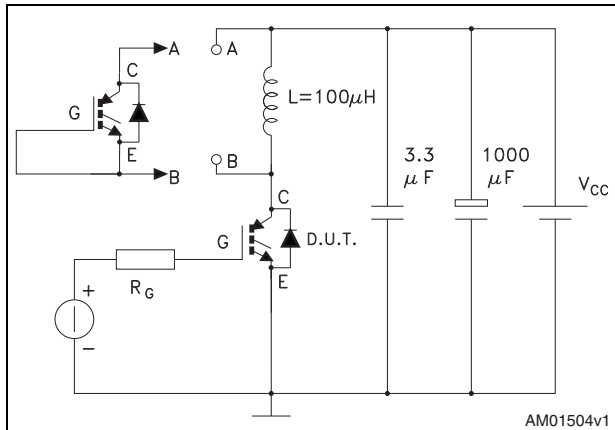

Figure 32. Thermal impedance for diode



3 Test circuits

Figure 33. Test circuit for inductive load switching



AM01504v1

Figure 34. Gate charge test circuit

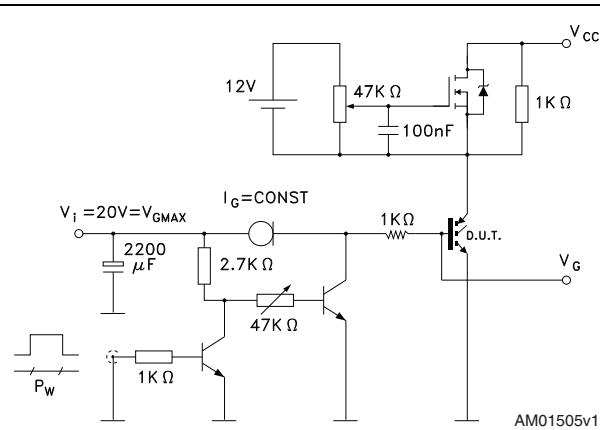

AM01505v1

Figure 35. Switching waveform

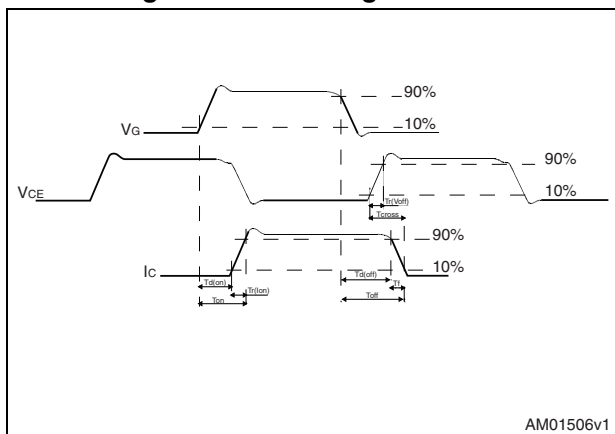

AM01506v1

Figure 36. Diode recovery time waveform

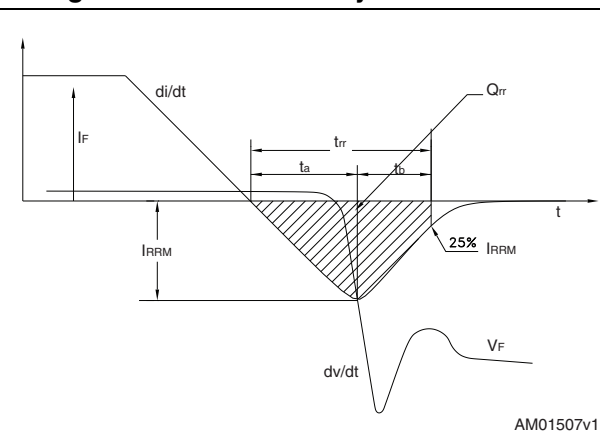

AM01507v1

4 Package mechanical data

In order to meet environmental requirements, ST offers these devices in different grades of ECOPACK[®] packages, depending on their level of environmental compliance. ECOPACK[®] specifications, grade definitions and product status are available at: www.st.com. ECOPACK[®] is an ST trademark.

Table 9. D²PAK mechanical data

Dim.	mm		
	Min.	Typ.	Max.
A	4.40		4.60
A1	0.03		0.23
b	0.70		0.93
b2	1.14		1.70
c	0.45		0.60
c2	1.23		1.36
D	8.95		9.35
D1	7.50		
E	10		10.40
E1	8.50		
e		2.54	
e1	4.88		5.28
H	15		15.85
J1	2.49		2.69
L	2.29		2.79
L1	1.27		1.40
L2	1.30		1.75
R		0.4	
V2	0°		8°

Figure 37. D²PAK drawing

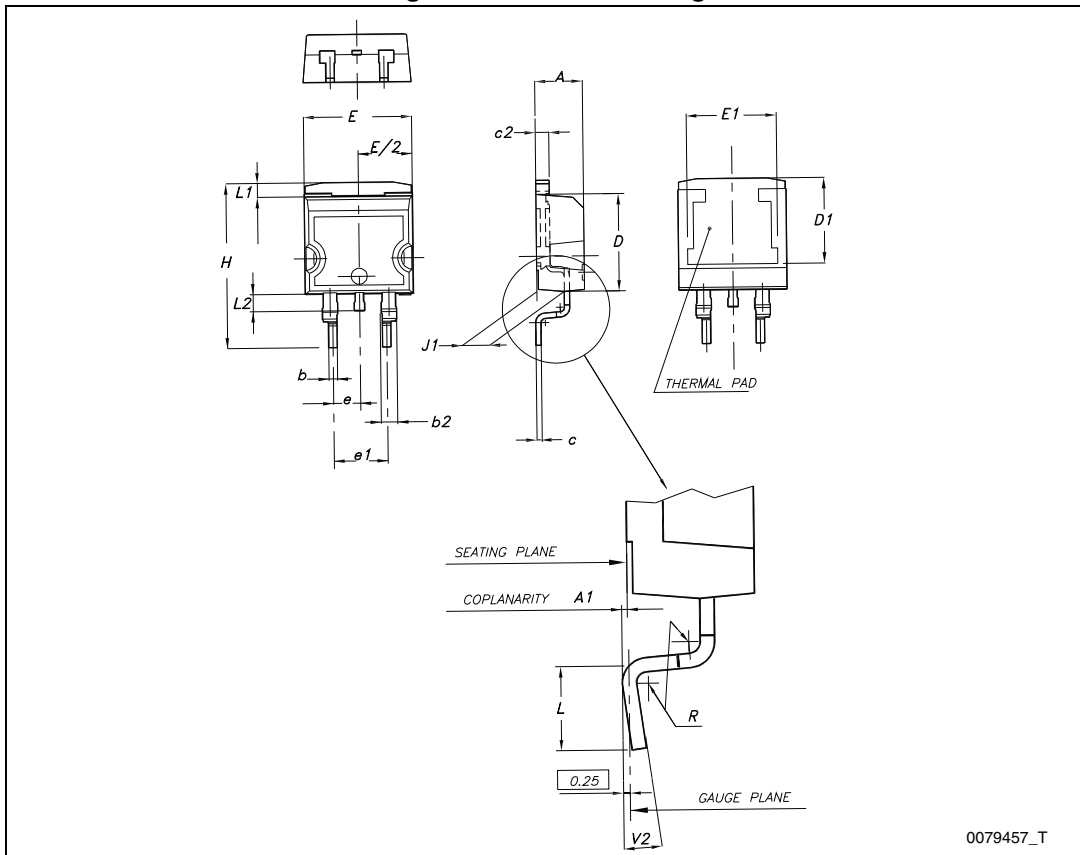

0079457_T

Figure 38. D²PAK footprint^(a)

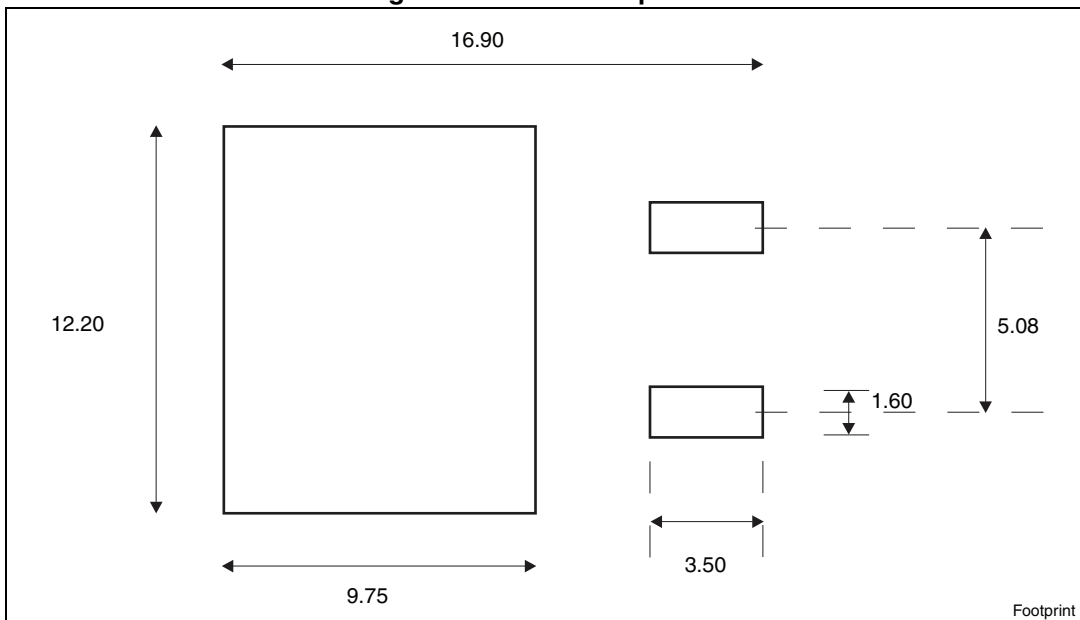

Footprint

a. All dimension are in millimeters

Table 10. TO-220FP mechanical data

Dim.	mm		
	Min.	Typ.	Max.
A	4.4		4.6
B	2.5		2.7
D	2.5		2.75
E	0.45		0.7
F	0.75		1
F1	1.15		1.70
F2	1.15		1.70
G	4.95		5.2
G1	2.4		2.7
H	10		10.4
L2		16	
L3	28.6		30.6
L4	9.8		10.6
L5	2.9		3.6
L6	15.9		16.4
L7	9		9.3
Dia	3		3.2

Figure 39. TO-220FP drawing

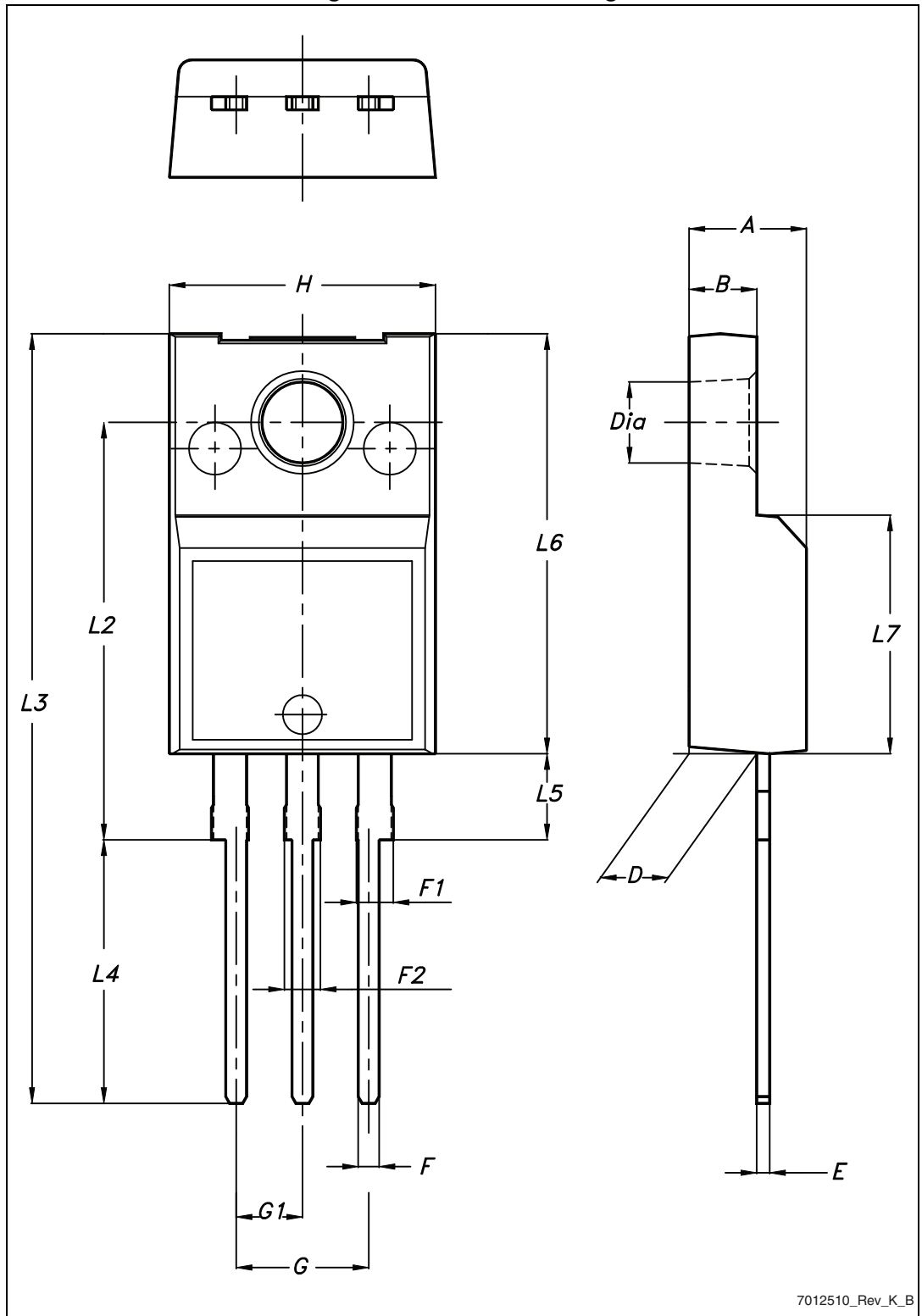

7012510_Rev_K_B

Table 11. TO-220 type A mechanical data

Dim.	mm		
	Min.	Typ.	Max.
A	4.40		4.60
b	0.61		0.88
b1	1.14		1.70
c	0.48		0.70
D	15.25		15.75
D1		1.27	
E	10		10.40
e	2.40		2.70
e1	4.95		5.15
F	1.23		1.32
H1	6.20		6.60
J1	2.40		2.72
L	13		14
L1	3.50		3.93
L20		16.40	
L30		28.90	
ØP	3.75		3.85
Q	2.65		2.95

Figure 40. TO-220 type A drawing

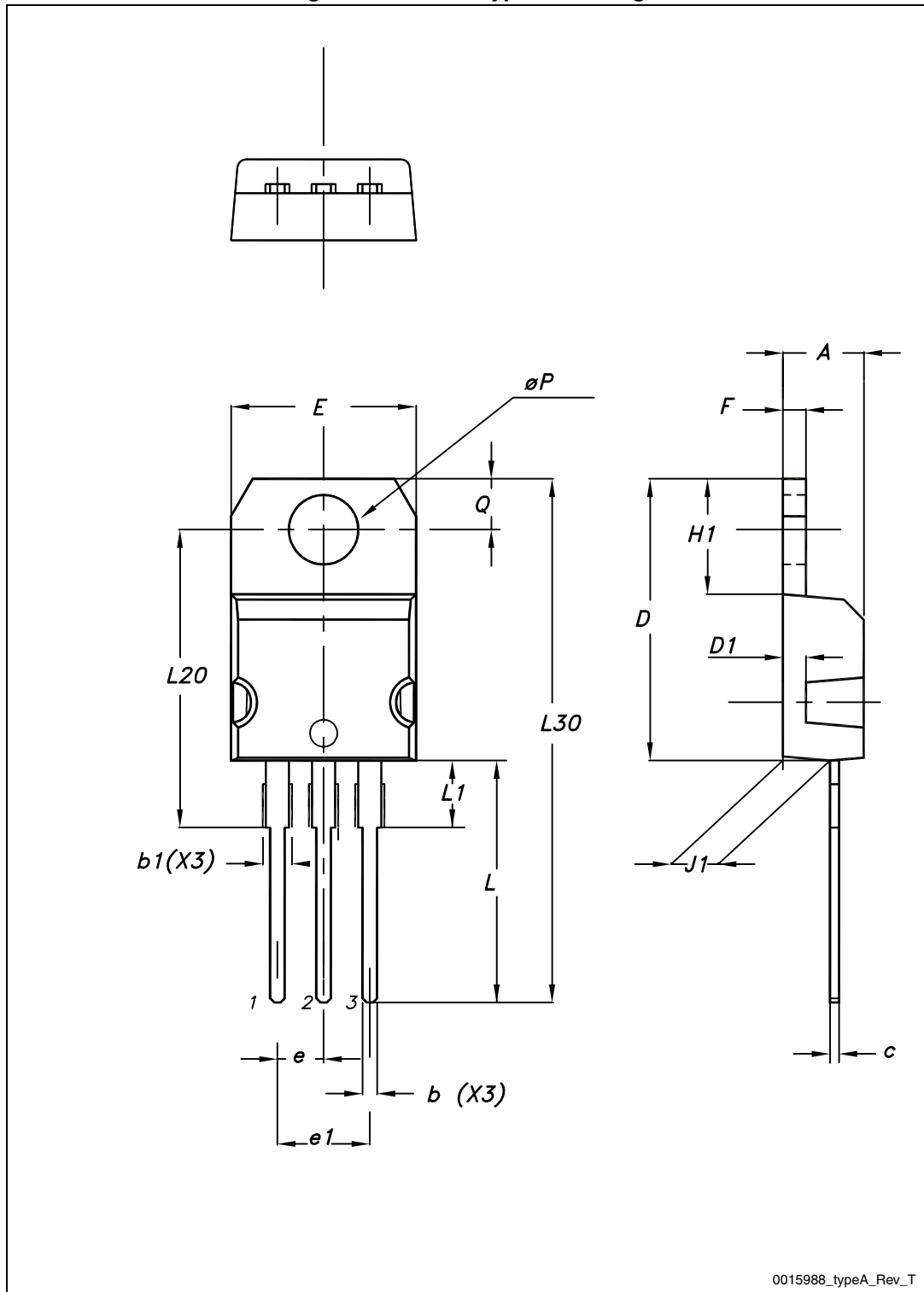

5 Packaging mechanical data

Table 12. D²PAK tape and reel mechanical data

Tape			Reel		
Dim.	mm		Dim.	mm	
	Min.	Max.		Min.	Max.
A0	10.5	10.7	A		330
B0	15.7	15.9	B	1.5	
D	1.5	1.6	C	12.8	13.2
D1	1.59	1.61	D	20.2	
E	1.65	1.85	G	24.4	26.4
F	11.4	11.6	N	100	
K0	4.8	5.0	T		30.4
P0	3.9	4.1			
P1	11.9	12.1	Base qty		1000
P2	1.9	2.1	Bulk qty		1000
R	50				
T	0.25	0.35			
W	23.7	24.3			

Figure 41. Tape

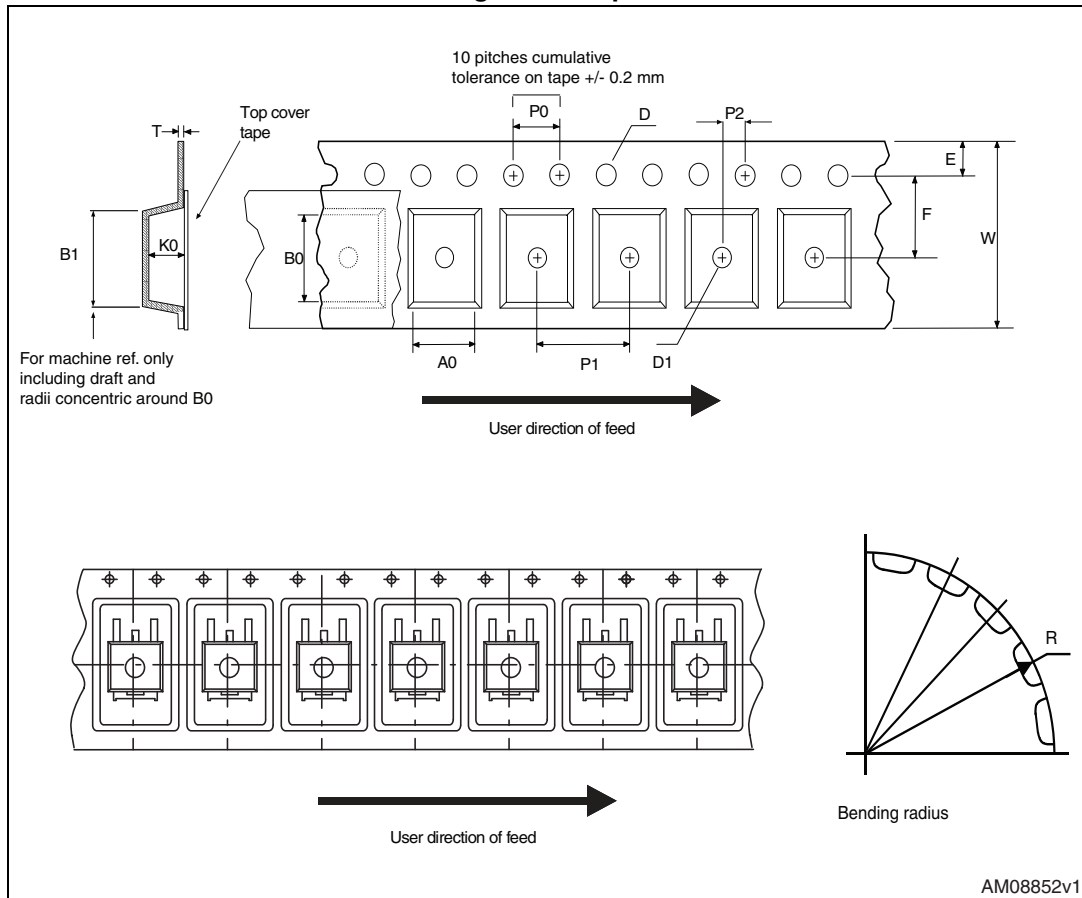
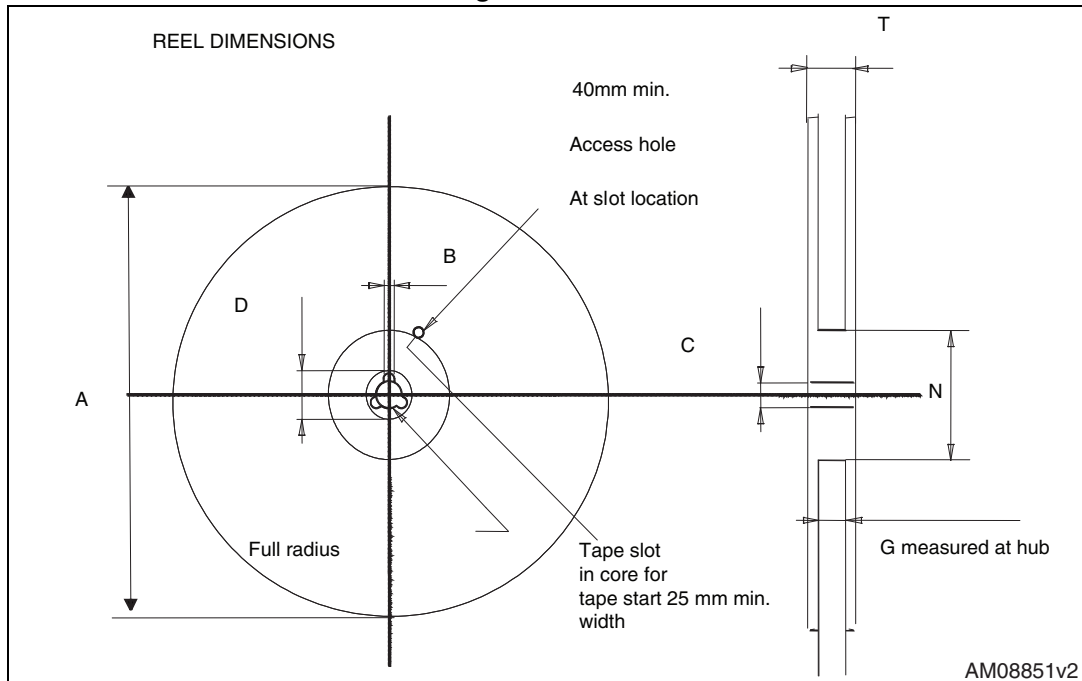

Figure 42. Reel



6 Revision history

Table 13. Document revision history

Date	Revision	Changes
12-Aug-2013	1	Initial release.
17-Oct-2013	2	<ul style="list-style-type: none">– Document status promoted from preliminary to production data.– Added Section 2.1: Electrical characteristics (curves).– Minor text changes.

Please Read Carefully:

Information in this document is provided solely in connection with ST products. STMicroelectronics NV and its subsidiaries ("ST") reserve the right to make changes, corrections, modifications or improvements, to this document, and the products and services described herein at any time, without notice.

All ST products are sold pursuant to ST's terms and conditions of sale.

Purchasers are solely responsible for the choice, selection and use of the ST products and services described herein, and ST assumes no liability whatsoever relating to the choice, selection or use of the ST products and services described herein.

No license, express or implied, by estoppel or otherwise, to any intellectual property rights is granted under this document. If any part of this document refers to any third party products or services it shall not be deemed a license grant by ST for the use of such third party products or services, or any intellectual property contained therein or considered as a warranty covering the use in any manner whatsoever of such third party products or services or any intellectual property contained therein.

UNLESS OTHERWISE SET FORTH IN ST'S TERMS AND CONDITIONS OF SALE ST DISCLAIMS ANY EXPRESS OR IMPLIED WARRANTY WITH RESPECT TO THE USE AND/OR SALE OF ST PRODUCTS INCLUDING WITHOUT LIMITATION IMPLIED WARRANTIES OF MERCHANTABILITY, FITNESS FOR A PARTICULAR PURPOSE (AND THEIR EQUIVALENTS UNDER THE LAWS OF ANY JURISDICTION), OR INFRINGEMENT OF ANY PATENT, COPYRIGHT OR OTHER INTELLECTUAL PROPERTY RIGHT.

ST PRODUCTS ARE NOT DESIGNED OR AUTHORIZED FOR USE IN: (A) SAFETY CRITICAL APPLICATIONS SUCH AS LIFE SUPPORTING, ACTIVE IMPLANTED DEVICES OR SYSTEMS WITH PRODUCT FUNCTIONAL SAFETY REQUIREMENTS; (B) AERONAUTIC APPLICATIONS; (C) AUTOMOTIVE APPLICATIONS OR ENVIRONMENTS, AND/OR (D) AEROSPACE APPLICATIONS OR ENVIRONMENTS. WHERE ST PRODUCTS ARE NOT DESIGNED FOR SUCH USE, THE PURCHASER SHALL USE PRODUCTS AT PURCHASER'S SOLE RISK, EVEN IF ST HAS BEEN INFORMED IN WRITING OF SUCH USAGE, UNLESS A PRODUCT IS EXPRESSLY DESIGNATED BY ST AS BEING INTENDED FOR "AUTOMOTIVE, AUTOMOTIVE SAFETY OR MEDICAL" INDUSTRY DOMAINS ACCORDING TO ST PRODUCT DESIGN SPECIFICATIONS. PRODUCTS FORMALLY ESCC, QML OR JAN QUALIFIED ARE DEEMED SUITABLE FOR USE IN AEROSPACE BY THE CORRESPONDING GOVERNMENTAL AGENCY.

Resale of ST products with provisions different from the statements and/or technical features set forth in this document shall immediately void any warranty granted by ST for the ST product or service described herein and shall not create or extend in any manner whatsoever, any liability of ST.

ST and the ST logo are trademarks or registered trademarks of ST in various countries.
Information in this document supersedes and replaces all information previously supplied.

The ST logo is a registered trademark of STMicroelectronics. All other names are the property of their respective owners.

© 2013 STMicroelectronics - All rights reserved

STMicroelectronics group of companies

Australia - Belgium - Brazil - Canada - China - Czech Republic - Finland - France - Germany - Hong Kong - India - Israel - Italy - Japan - Malaysia - Malta - Morocco - Philippines - Singapore - Spain - Sweden - Switzerland - United Kingdom - United States of America

www.st.com

