



Chipsmall Limited consists of a professional team with an average of over 10 year of expertise in the distribution of electronic components. Based in Hongkong, we have already established firm and mutual-benefit business relationships with customers from,Europe,America and south Asia,supplying obsolete and hard-to-find components to meet their specific needs.

With the principle of “Quality Parts,Customers Priority,Honest Operation,and Considerate Service”,our business mainly focus on the distribution of electronic components. Line cards we deal with include Microchip,ALPS,ROHM,Xilinx,Pulse,ON,Everlight and Freescale. Main products comprise IC,Modules,Potentiometer,IC Socket,Relay,Connector.Our parts cover such applications as commercial,industrial, and automotives areas.

We are looking forward to setting up business relationship with you and hope to provide you with the best service and solution. Let us make a better world for our industry!



Contact us

Tel: +86-755-8981 8866 Fax: +86-755-8427 6832

Email & Skype: info@chipsmall.com Web: www.chipsmall.com

Address: A1208, Overseas Decoration Building, #122 Zhenhua RD., Futian, Shenzhen, China



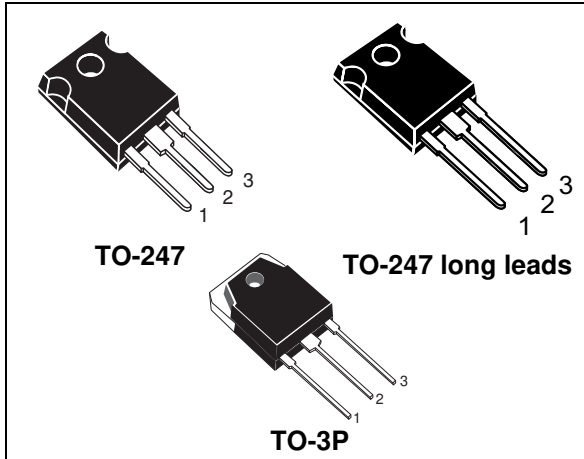
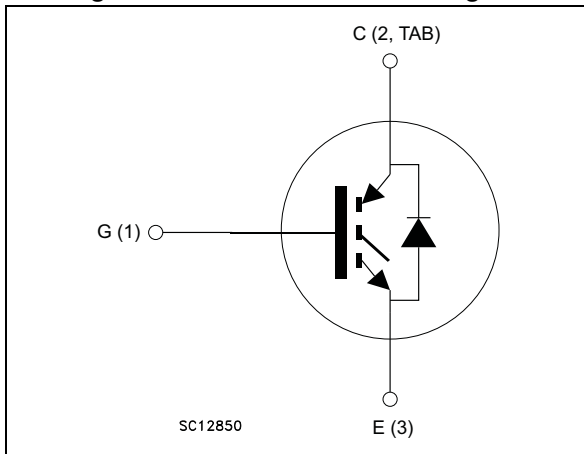

Figure 1. Internal schematic diagram



Features

- Maximum junction temperature: $T_J = 175\text{ }^\circ\text{C}$
- High speed switching series
- Minimized tail current
- $V_{CE(sat)} = 1.55\text{ V (typ.) @ } I_C = 30\text{ A}$
- Tight parameters distribution
- Safe paralleling
- Low thermal resistance
- Very fast soft recovery antiparallel diode

Applications

- Photovoltaic inverters
- High frequency converters

Description

These devices are IGBTs developed using an advanced proprietary trench gate field-stop structure. These devices are part of the new HB series of IGBTs, which represent an optimum compromise between conduction and switching loss to maximize the efficiency of any frequency converter. Furthermore, the slightly positive $V_{CE(sat)}$ temperature coefficient and very tight parameter distribution result in safer paralleling operation.

Table 1. Device summary

Order code	Marking	Package	Packaging
STGW30H60DFB	GW30H60DFB	TO-247	Tube
STGWA30H60DFB	GWA30H60DFB	TO-247 long leads	Tube
STGWT30H60DFB	GWT30H60DFB	TO-3P	Tube

Contents

1	Electrical ratings	3
2	Electrical characteristics	4
	2.1 Electrical characteristics (curve)	6
3	Test circuits	12
4	Package information	13
	4.1 TO-247 package information	13
	4.2 TO-247 long leads package information	15
	4.3 TO-3P package information	17
5	Revision history	19

1 Electrical ratings

Table 2. Absolute maximum ratings

Symbol	Parameter	Value	Unit
V_{CES}	Collector-emitter voltage ($V_{GE} = 0$)	600	V
I_C	Continuous collector current at $T_C = 25\text{ °C}$	60	A
I_C	Continuous collector current at $T_C = 100\text{ °C}$	30	A
$I_{CP}^{(1)}$	Pulsed collector current	120	A
I_F	Continuous forward current at $T_C = 25\text{ °C}$	60	A
I_F	Continuous forward current at $T_C = 100\text{ °C}$	30	A
$I_{FP}^{(1)}$	Pulsed forward current	120	A
V_{GE}	Gate-emitter voltage	± 20	V
P_{TOT}	Total dissipation at $T_C = 25\text{ °C}$	260	W
T_{STG}	Storage temperature range	- 55 to 150	°C
T_J	Operating junction temperature range	- 55 to 175	°C

1. Pulse width limited by maximum junction temperature.

Table 3. Thermal data

Symbol	Parameter	Value	Unit
R_{thJC}	Thermal resistance junction-case IGBT	0.58	°C/W
R_{thJC}	Thermal resistance junction-case diode	2.08	°C/W
R_{thJA}	Thermal resistance junction-ambient	50	°C/W

2 Electrical characteristics

$T_J = 25\text{ °C}$ unless otherwise specified.

Table 4. Static characteristics

Symbol	Parameter	Test conditions	Min.	Typ.	Max.	Unit
$V_{(BR)CES}$	Collector-emitter breakdown voltage ($V_{GE} = 0$)	$I_C = 2\text{ mA}$	600			V
$V_{CE(sat)}$	Collector-emitter saturation voltage	$V_{GE} = 15\text{ V}, I_C = 30\text{ A}$		1.55	2	V
		$V_{GE} = 15\text{ V}, I_C = 30\text{ A}$ $T_J = 125\text{ °C}$		1.65		
		$V_{GE} = 15\text{ V}, I_C = 30\text{ A}$ $T_J = 175\text{ °C}$		1.75		
V_F	Forward on-voltage	$I_F = 30\text{ A}$		2	2.6	V
		$I_F = 30\text{ A}; T_J = 125\text{ °C}$		1.7		
		$I_F = 30\text{ A}; T_J = 175\text{ °C}$		1.6		
$V_{GE(th)}$	Gate threshold voltage	$V_{CE} = V_{GE}, I_C = 1\text{ mA}$	5	6	7	V
I_{CES}	Collector cut-off current ($V_{GE} = 0$)	$V_{CE} = 600\text{ V}$			25	μA
I_{GES}	Gate-emitter leakage current ($V_{CE} = 0$)	$V_{GE} = \pm 20\text{ V}$			± 250	nA

Table 5. Dynamic characteristics

Symbol	Parameter	Test conditions	Min.	Typ.	Max.	Unit
C_{ies}	Input capacitance	$V_{CE} = 25\text{ V}, f = 1\text{ MHz},$ $V_{GE} = 0$	-	3659	-	pF
C_{oes}	Output capacitance		-	101	-	pF
C_{res}	Reverse transfer capacitance		-	76	-	pF
Q_g	Total gate charge	$V_{CC} = 520\text{ V}, I_C = 30\text{ A},$ $V_{GE} = 15\text{ V},$ see Figure 29	-	149	-	nC
Q_{ge}	Gate-emitter charge		-	25	-	nC
Q_{gc}	Gate-collector charge		-	62	-	nC

Table 6. Switching characteristics (inductive load)

Symbol	Parameter	Test conditions	Min.	Typ.	Max.	Unit
$t_{d(on)}$	Turn-on delay time	$V_{CE} = 400\text{ V}$, $I_C = 30\text{ A}$, $R_G = 10\ \Omega$, $V_{GE} = 15\text{ V}$, see Figure 28	-	37	-	ns
t_r	Current rise time		-	14.6	-	ns
$(di/dt)_{on}$	Turn-on current slope		-	1643	-	A/ μ s
$t_{d(off)}$	Turn-off delay time		-	146	-	ns
t_f	Current fall time		-	23	-	ns
$E_{on}^{(1)}$	Turn-on switching energy		-	383	-	μ J
$E_{off}^{(2)}$	Turn-off switching energy		-	293	-	μ J
E_{ts}	Total switching energy		-	676	-	μ J
$t_{d(on)}$	Turn-on delay time	$V_{CE} = 400\text{ V}$, $I_C = 30\text{ A}$, $R_G = 10\ \Omega$, $V_{GE} = 15\text{ V}$, $T_J = 175\text{ }^\circ\text{C}$, see Figure 28	-	35	-	ns
t_r	Current rise time		-	16.1	-	ns
$(di/dt)_{on}$	Turn-on current slope		-	1496	-	A/ μ s
$t_{d(off)}$	Turn-off delay time		-	158	-	ns
t_f	Current fall time		-	65	-	ns
$E_{on}^{(1)}$	Turn-on switching energy		-	794	-	μ J
$E_{off}^{(2)}$	Turn-off switching energy		-	572	-	μ J
E_{ts}	Total switching energy		-	1366	-	μ J

1. Including the reverse recovery of the diode.
2. Including the tail of the collector current.

Table 7. Diode switching characteristics (inductive load)

Symbol	Parameter	Test conditions	Min.	Typ.	Max.	Unit
t_{rr}	Reverse recovery time	$I_F = 30\text{ A}$, $V_R = 400\text{ V}$, $di/dt = 1000\text{ A}/\mu\text{s}$, $V_{GE} = 15\text{ V}$, (see Figure 28)	-	53	-	ns
Q_{rr}	Reverse recovery charge		-	384	-	nC
I_{rrm}	Reverse recovery current		-	14.5	-	A
dl_{rr}/dt	Peak rate of fall of reverse recovery current during t_b		-	788	-	A/ μ s
E_{rr}	Reverse recovery energy		-	104	-	μ J
t_{rr}	Reverse recovery time	$I_F = 30\text{ A}$, $V_R = 400\text{ V}$, $di/dt = 1000\text{ A}/\mu\text{s}$, $V_{GE} = 15\text{ V}$, $T_J = 175\text{ }^\circ\text{C}$, (see Figure 28)	-	104	-	ns
Q_{rr}	Reverse recovery charge		-	1352	-	nC
I_{rrm}	Reverse recovery current		-	26	-	A
dl_{rr}/dt	Peak rate of fall of reverse recovery current during t_b		-	310	-	A/ μ s
E_{rr}	Reverse recovery energy		-	407	-	μ J

2.1 Electrical characteristics (curve)

Figure 2. Power dissipation vs. case temperature

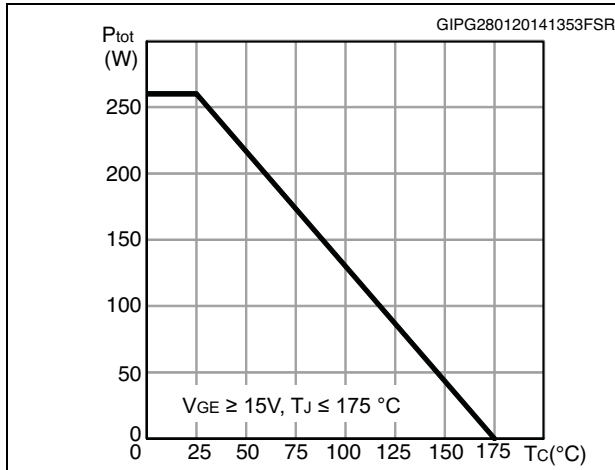

Figure 3. Collector current vs. case temperature

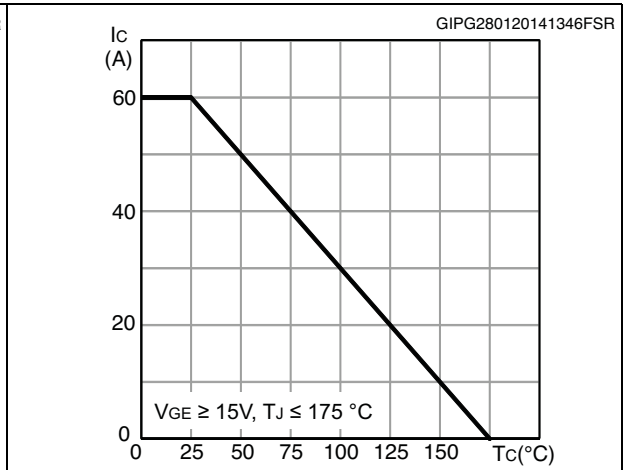

Figure 4. Output characteristics ($T_J = 25^\circ\text{C}$)

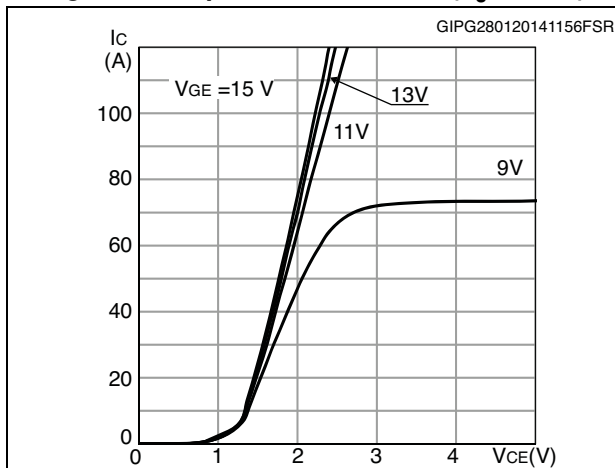

Figure 5. Output characteristics ($T_J = 175^\circ\text{C}$)

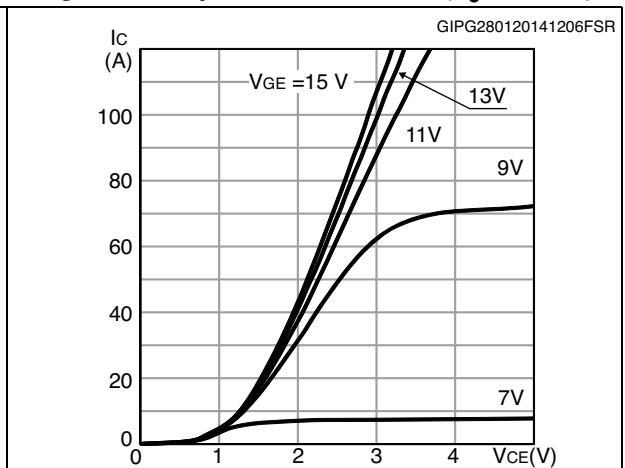

Figure 6. $V_{CE(sat)}$ vs. junction temperature

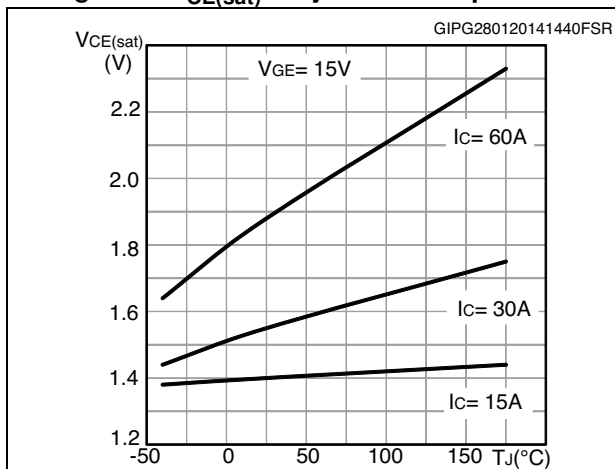

Figure 7. $V_{CE(sat)}$ vs. collector current

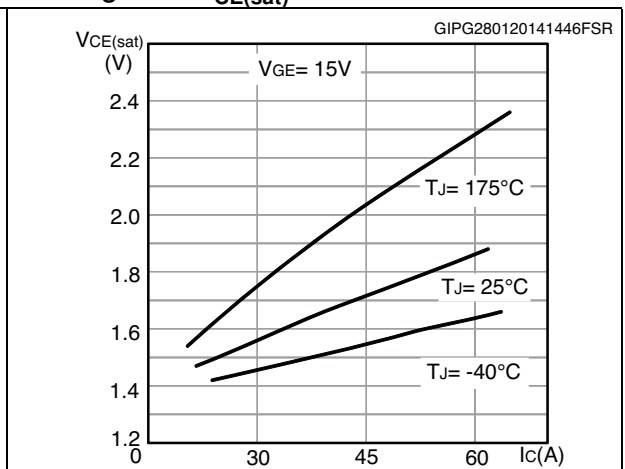

Figure 8. Collector current vs. switching frequency

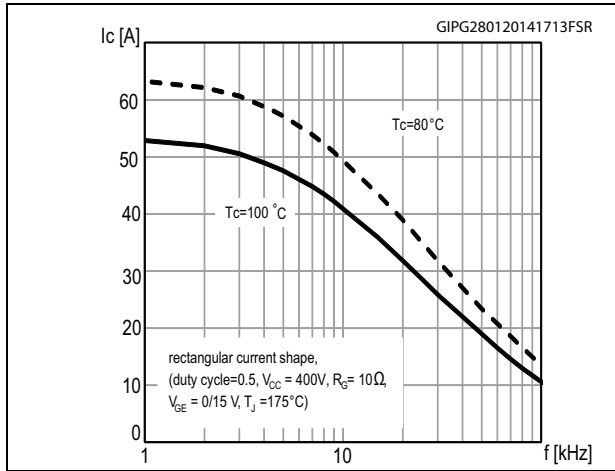

Figure 9. Forward bias safe operating area

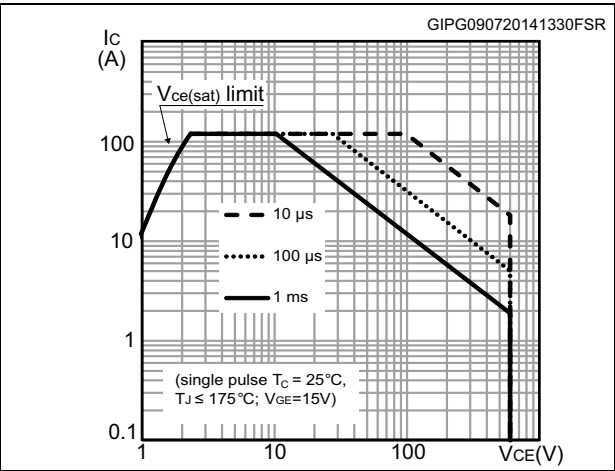

Figure 10. Transfer characteristics

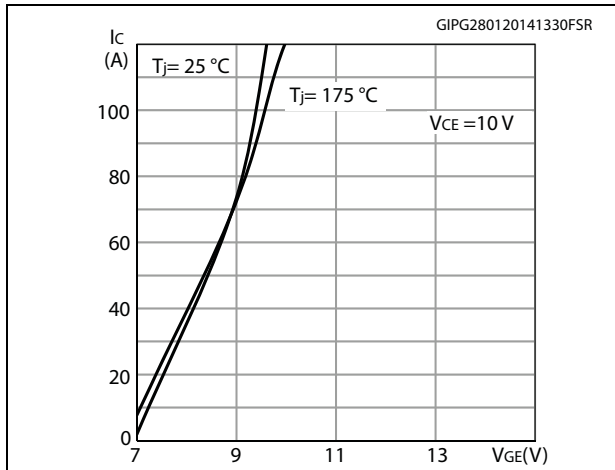

Figure 11. Diode V_F vs. forward current

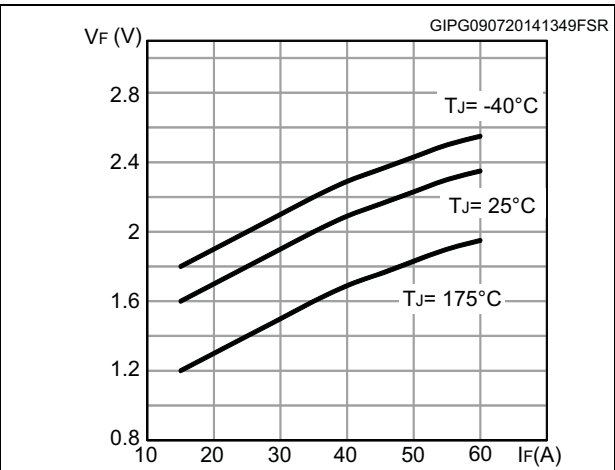

Figure 12. Normalized V_{GE(th)} vs junction temperature

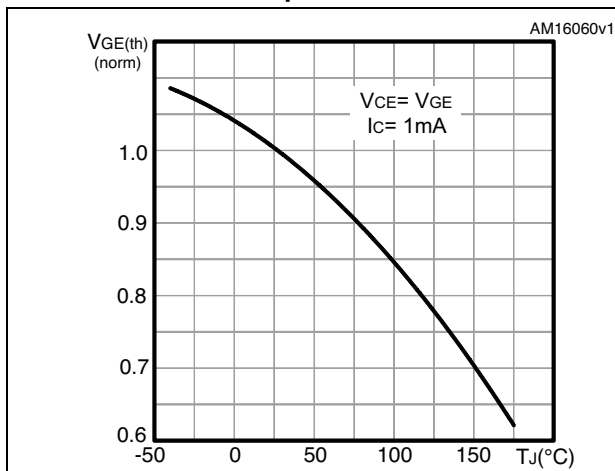

Figure 13. Normalized V_{(BR)CES} vs. junction temperature

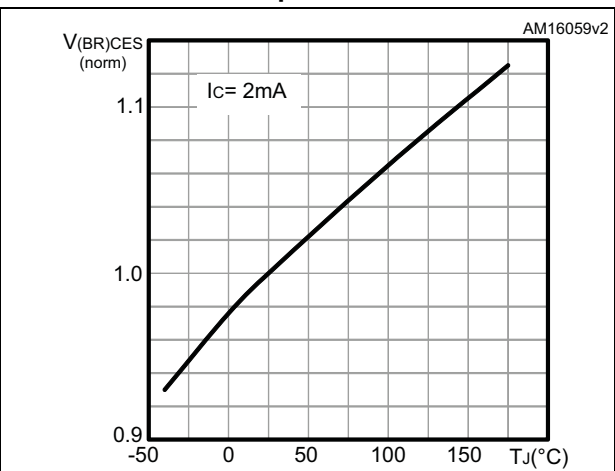

Figure 14. Capacitance variation

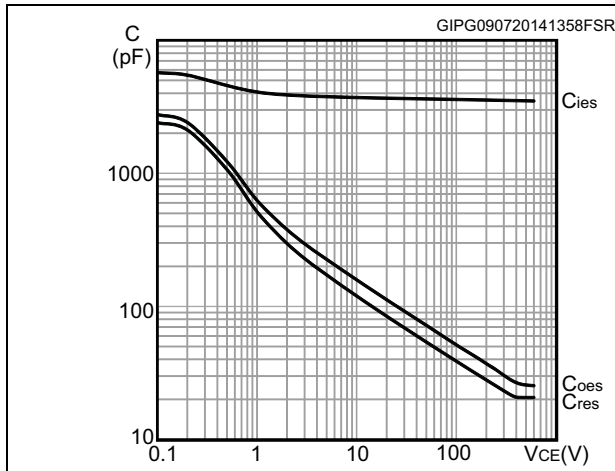

Figure 15. Gate charge vs. gate-emitter voltage

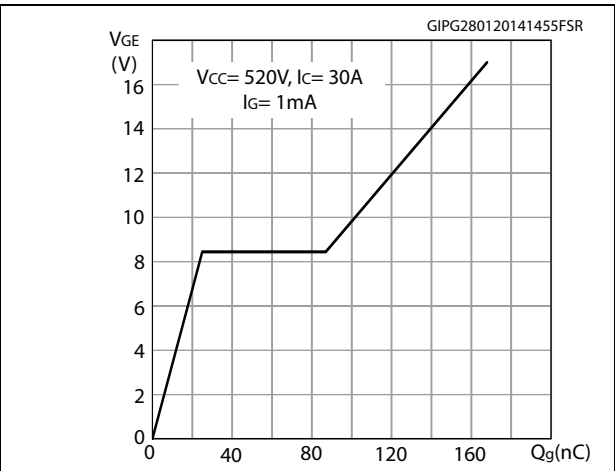

Figure 16. Switching energy vs collector current

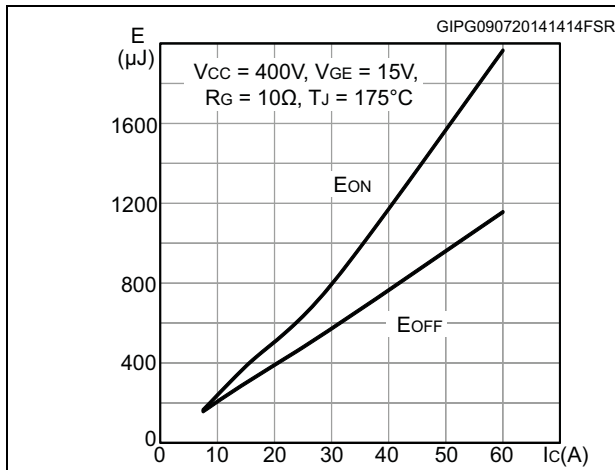

Figure 17. Switching energy vs gate resistance

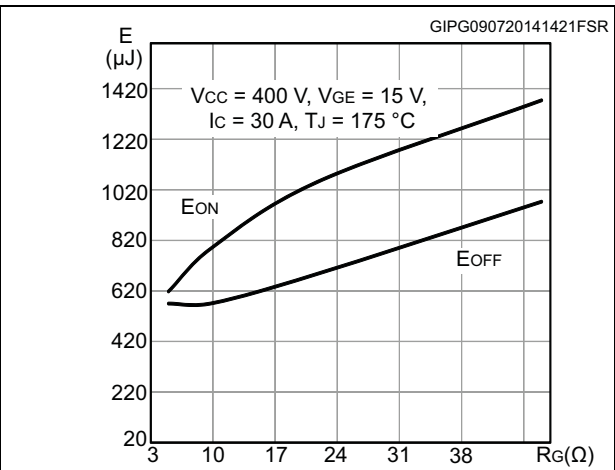

Figure 18. Switching energy vs temperature

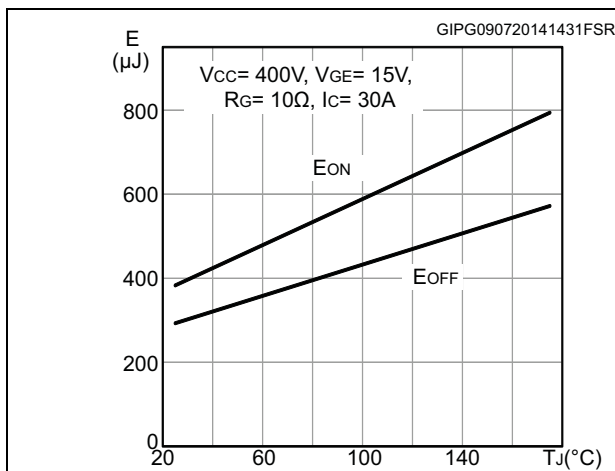

Figure 19. Switching energy vs collector-emitter voltage

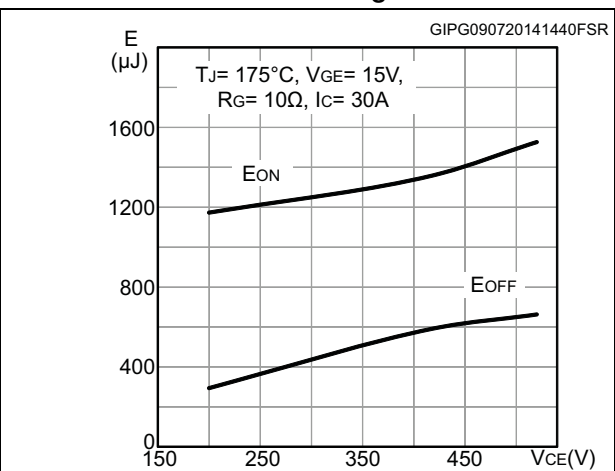

Figure 20. Switching times vs. collector current Figure 21. Switching times vs. gate resistance

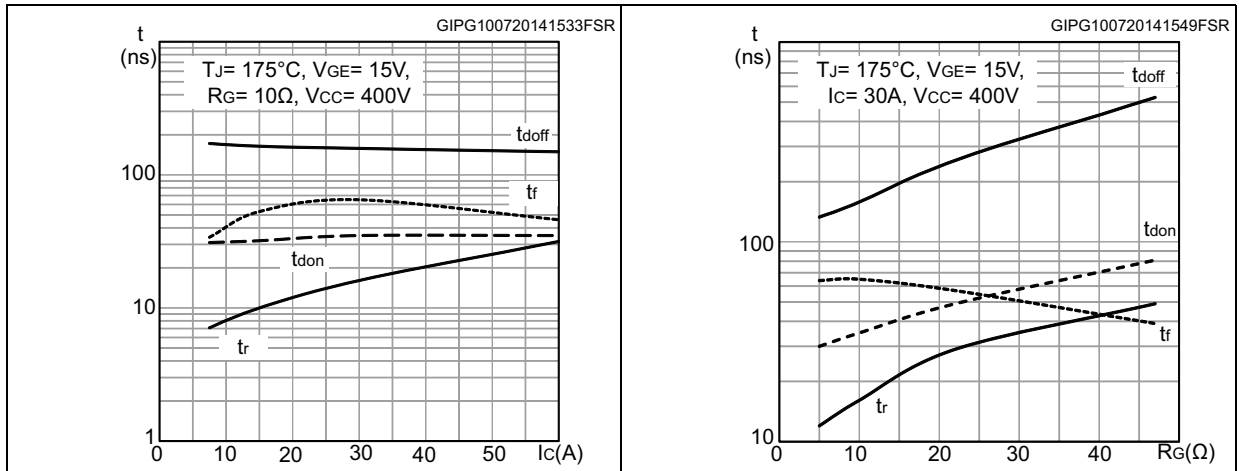

Figure 22. Reverse recovery current vs. diode current slope

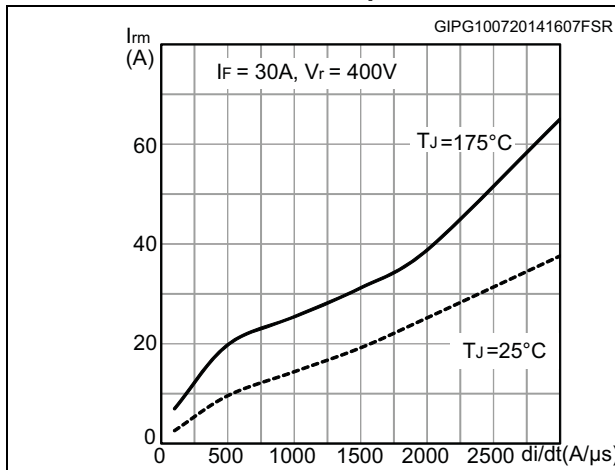

Figure 23. Reverse recovery time vs. diode current slope

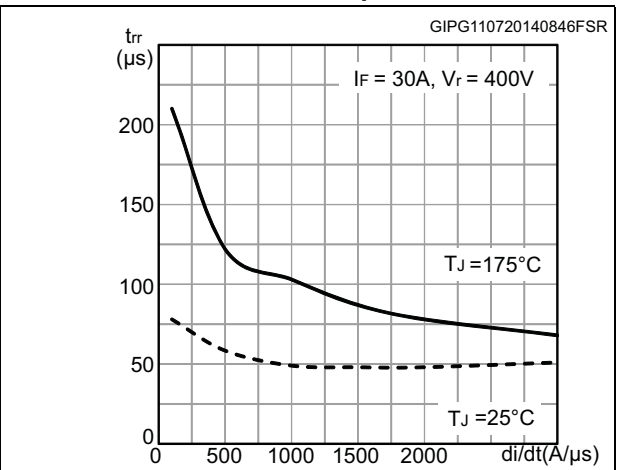

Figure 24. Reverse recovery charge vs. diode current slope

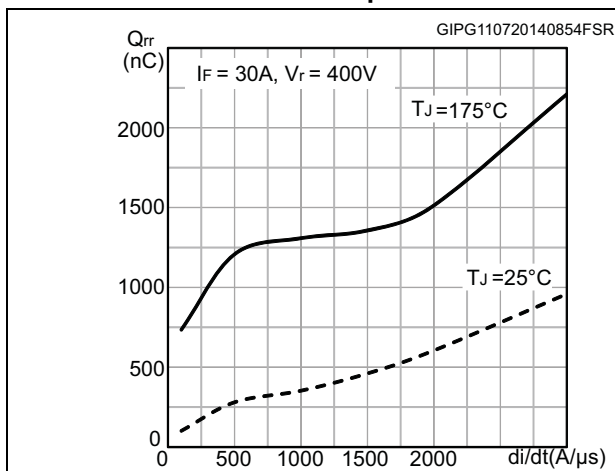

Figure 25. Reverse recovery energy vs. diode current slope

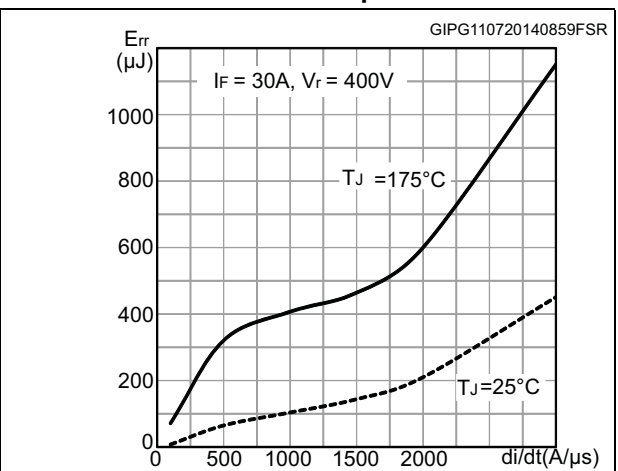

Figure 26. Thermal impedance for IGBT

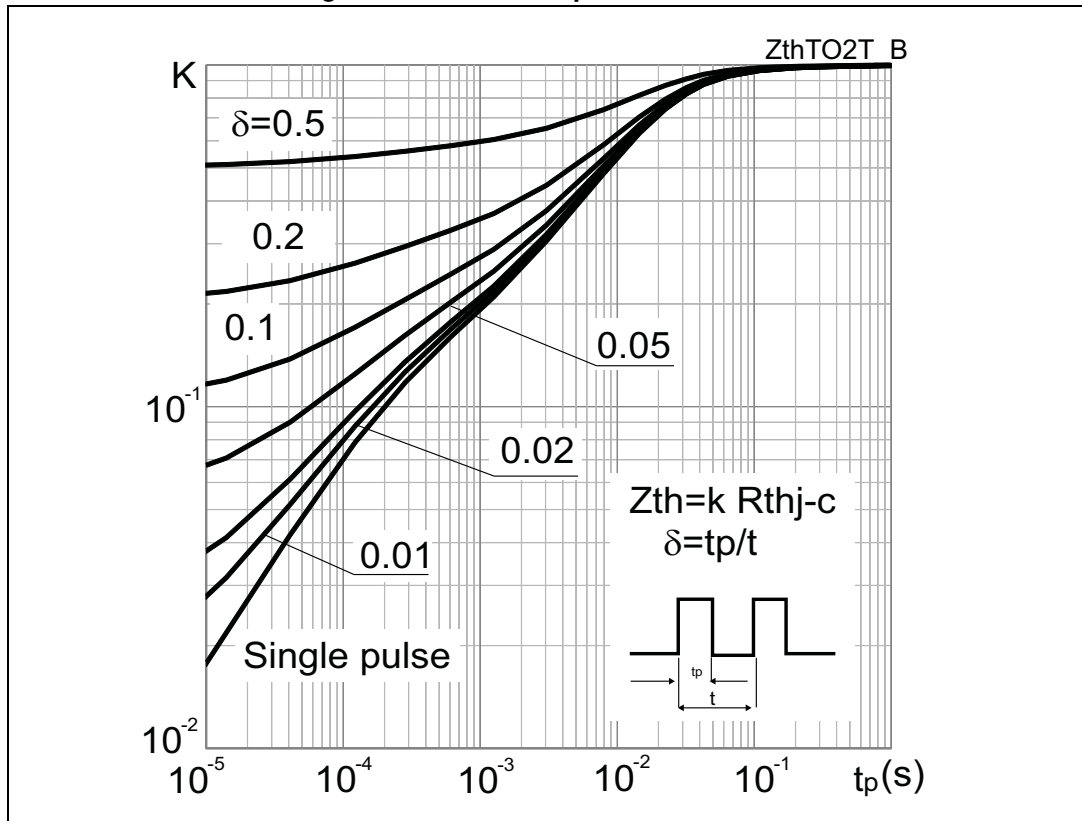
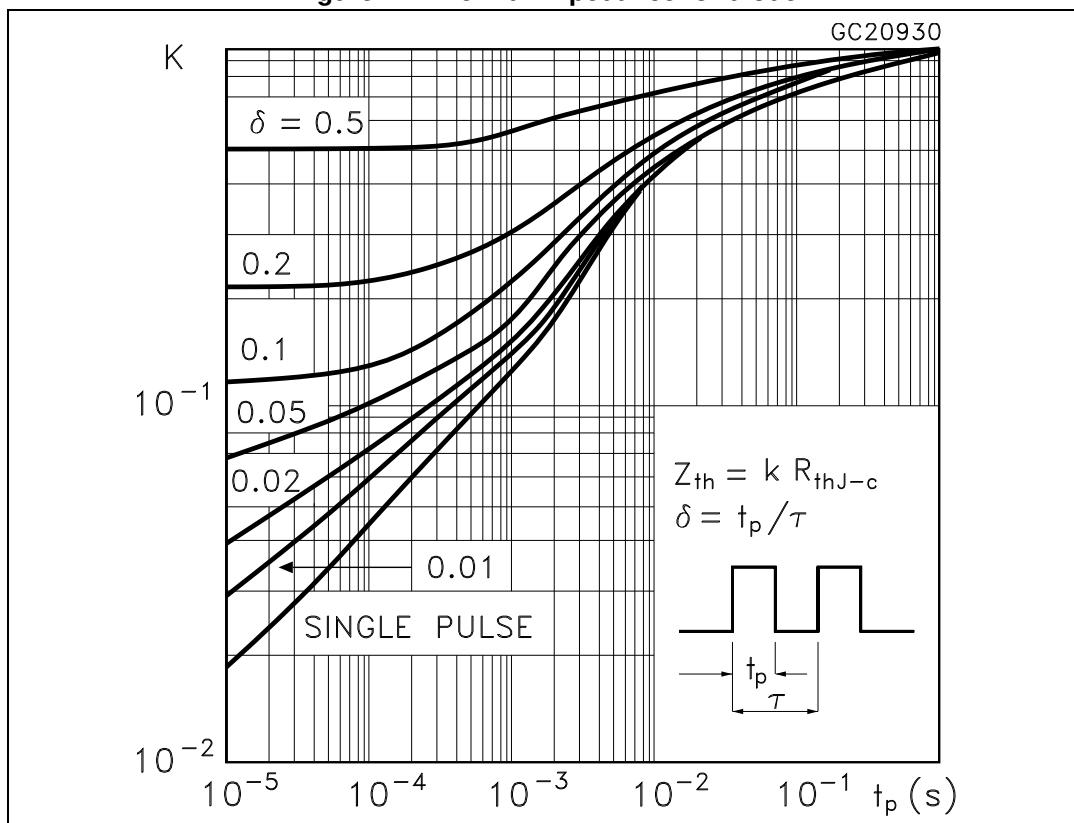

Figure 27. Thermal impedance for diode



3 Test circuits

Figure 28. Test circuit for inductive load switching

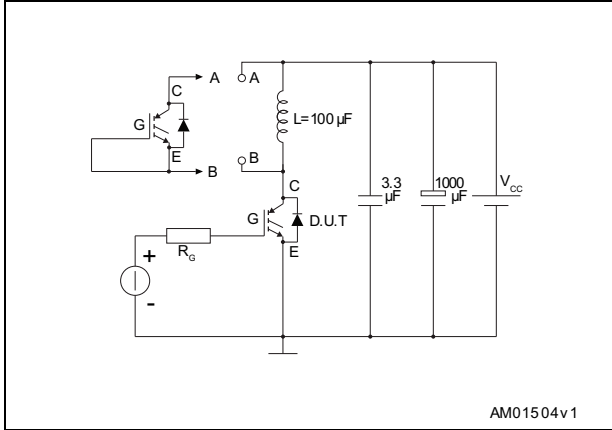

Figure 29. Gate charge test circuit

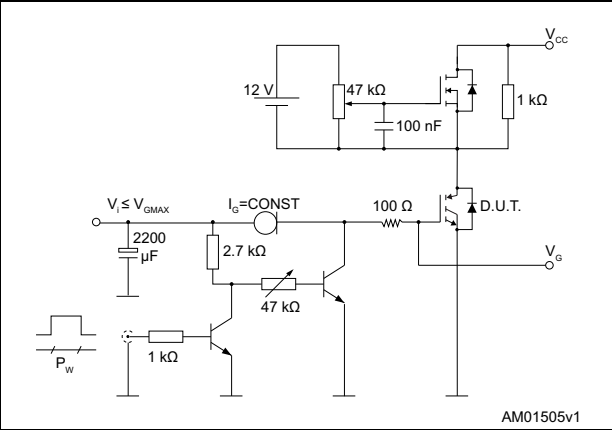

Figure 30. Switching waveform

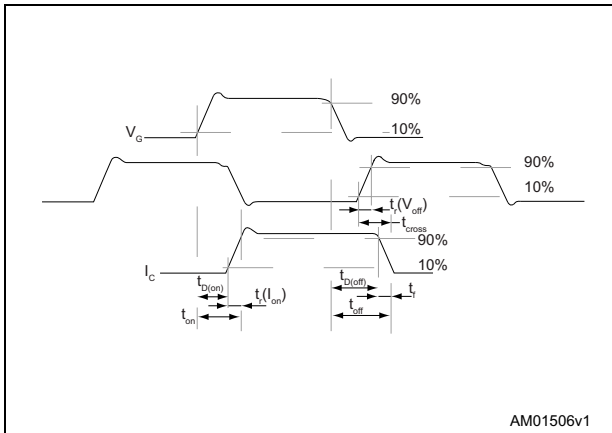
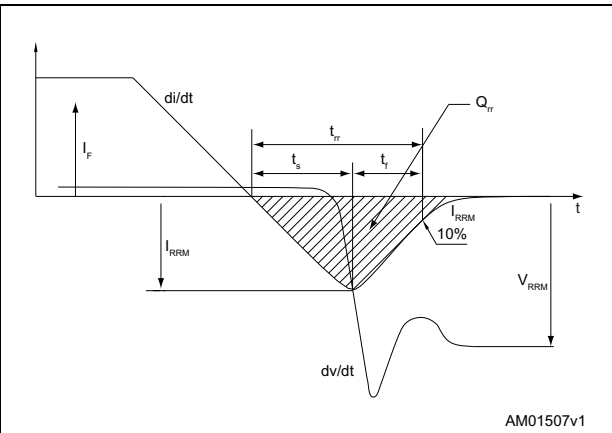

Figure 31. Diode reverse recovery waveform



4 Package information

In order to meet environmental requirements, ST offers these devices in different grades of ECOPACK® packages, depending on their level of environmental compliance. ECOPACK® specifications, grade definitions and product status are available at: www.st.com. ECOPACK is an ST trademark.

4.1 TO-247 package information

Figure 32. TO-247 package outline

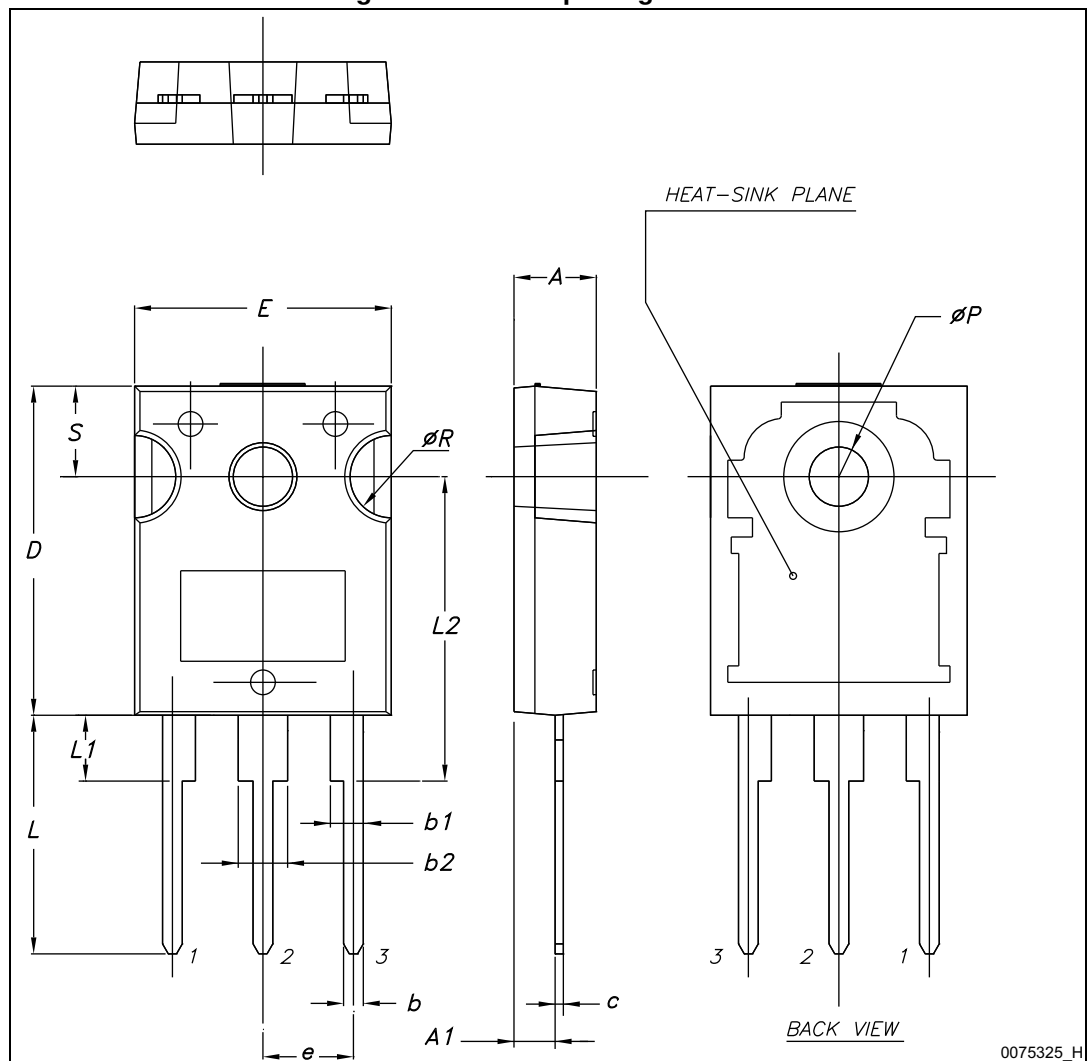

Table 8. TO-247 package mechanical data

Dim.	mm.		
	Min.	Typ.	Max.
A	4.85		5.15
A1	2.20		2.60
b	1.0		1.40
b1	2.0		2.40
b2	3.0		3.40
c	0.40		0.80
D	19.85		20.15
E	15.45		15.75
e	5.30	5.45	5.60
L	14.20		14.80
L1	3.70		4.30
L2		18.50	
ØP	3.55		3.65
ØR	4.50		5.50
S	5.30	5.50	5.70

4.2 TO-247 long leads package information

Figure 33. TO-247 long leads package outline

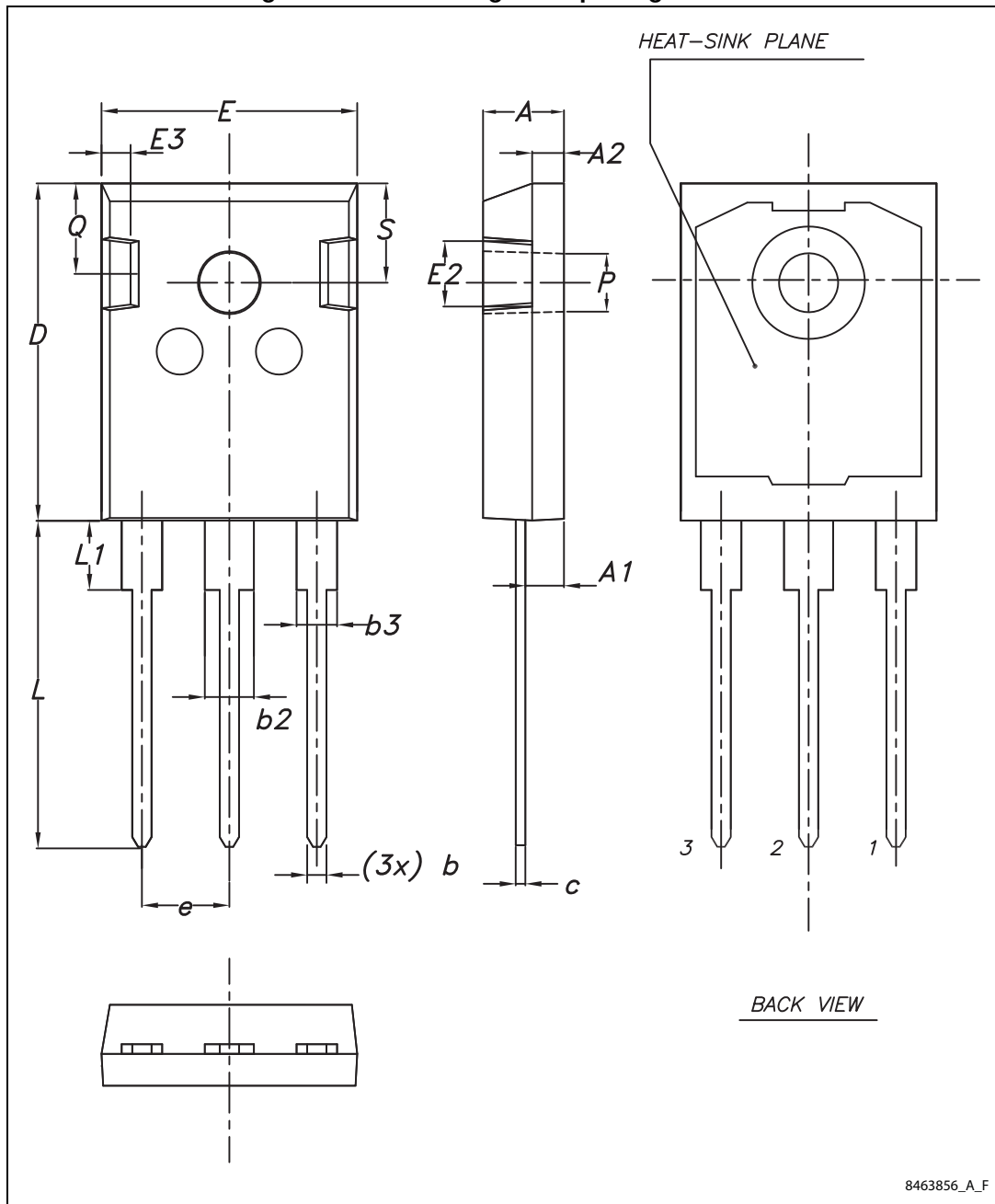
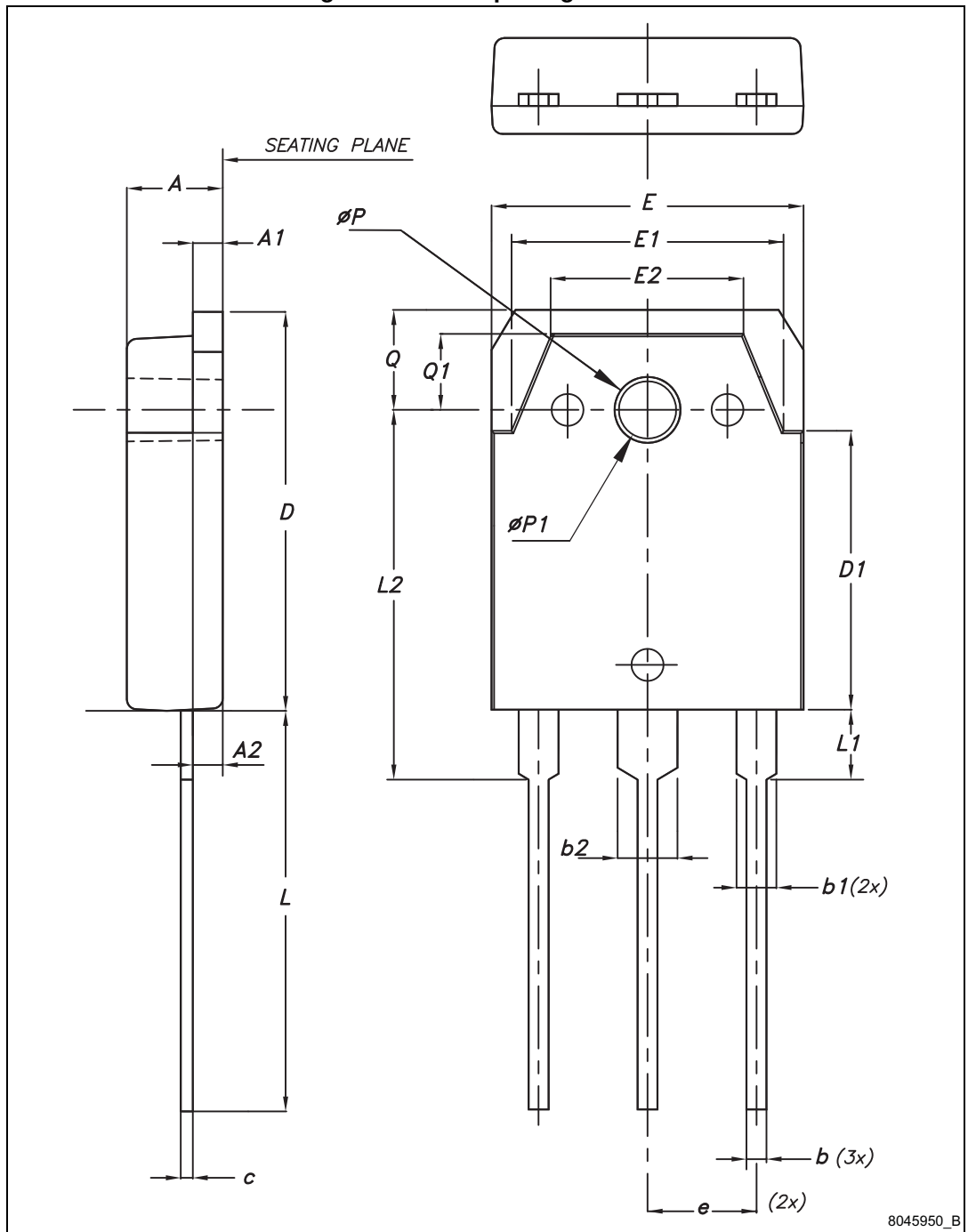

Table 9. TO-247 long leads package mechanical data

Dim.	mm		
	Min.	Typ.	Max.
A	4.90	5.00	5.10
A1	2.31	2.41	2.51
A2	1.90	2.00	2.10
b	1.16		1.26
b2			3.25
b3			2.25
c	0.59		0.66
D	20.90	21.00	21.10
E	15.70	15.80	15.90
E2	4.90	5.00	5.10
E3	2.40	2.50	2.60
e	5.34	5.44	5.54
L	19.80	19.92	20.10
L1			4.30
P	3.50	3.60	3.70
Q	5.60		6.00
S	6.05	6.15	6.25

4.3 TO-3P package information

Figure 34. TO-3P package outline



8045950_B

Table 10. TO-3P package mechanical data

Dim.	mm		
	Min.	Typ.	Max.
A	4.60	4.80	5
A1	1.45	1.50	1.65
A2	1.20	1.40	1.60
b	0.80	1.00	1.20
b1	1.80	2.00	2.20
b2	2.80	3.00	3.20
c	0.55	0.60	0.75
D	19.70	19.90	20.10
D1	13.70	13.90	14.10
E	15.40	15.60	15.80
E1	13.40	13.60	13.80
E2	9.40	9.60	9.90
e	5.15	5.45	5.75
L	19.80	20	20.20
L1	3.30	3.50	3.70
L2	18.20	18.40	18.60
øP	3.30	3.40	3.50
øP1	3.10	3.20	3.30
Q	4.80	5	5.20
Q1	3.60	3.80	4

5 Revision history

Table 11. Document revision history

Date	Revision	Changes
01-Aug-2014	1	Initial release.
17-Feb-2016	2	Modified: <i>Table 2, Table 4 and 6</i> Modified: <i>Figure 16</i> Updated: <i>Section 3</i> Updated: <i>Section 4.1: TO-247, STGW30H60DFB</i> Minor text changes
04-Nov-2016	3	Added device in TO-247 long leads. Document updated accordingly. Minor text changes.

IMPORTANT NOTICE – PLEASE READ CAREFULLY

STMicroelectronics NV and its subsidiaries ("ST") reserve the right to make changes, corrections, enhancements, modifications, and improvements to ST products and/or to this document at any time without notice. Purchasers should obtain the latest relevant information on ST products before placing orders. ST products are sold pursuant to ST's terms and conditions of sale in place at the time of order acknowledgement.

Purchasers are solely responsible for the choice, selection, and use of ST products and ST assumes no liability for application assistance or the design of Purchasers' products.

No license, express or implied, to any intellectual property right is granted by ST herein.

Resale of ST products with provisions different from the information set forth herein shall void any warranty granted by ST for such product.

ST and the ST logo are trademarks of ST. All other product or service names are the property of their respective owners.

Information in this document supersedes and replaces information previously supplied in any prior versions of this document.

© 2016 STMicroelectronics – All rights reserved