



Chipsmall Limited consists of a professional team with an average of over 10 year of expertise in the distribution of electronic components. Based in Hongkong, we have already established firm and mutual-benefit business relationships with customers from,Europe,America and south Asia,supplying obsolete and hard-to-find components to meet their specific needs.

With the principle of “Quality Parts,Customers Priority,Honest Operation,and Considerate Service”,our business mainly focus on the distribution of electronic components. Line cards we deal with include Microchip,ALPS,ROHM,Xilinx,Pulse,ON,Everlight and Freescale. Main products comprise IC,Modules,Potentiometer,IC Socket,Relay,Connector.Our parts cover such applications as commercial,industrial, and automotives areas.

We are looking forward to setting up business relationship with you and hope to provide you with the best service and solution. Let us make a better world for our industry!



Contact us

Tel: +86-755-8981 8866 Fax: +86-755-8427 6832

Email & Skype: info@chipsmall.com Web: www.chipsmall.com

Address: A1208, Overseas Decoration Building, #122 Zhenhua RD., Futian, Shenzhen, China





STPS40150CG/CT/CW

HIGH VOLTAGE POWER SCHOTTKY RECTIFIER

MAJOR PRODUCTS CHARACTERISTICS

$I_{F(AV)}$	2 x 20 A
V_{RRM}	150 V
T_j (max)	175°C
V_F (max)	0.75 V

FEATURES AND BENEFITS

- HIGH JUNCTION TEMPERATURE CAPABILITY
- LOW LEAKAGE CURRENT
- GOOD TRADE OFF BETWEEN LEAKAGE CURRENT AND FORWARD VOLTAGE DROP
- LOW THERMAL RESISTANCE
- HIGH FREQUENCY OPERATION

DESCRIPTION

Dual center tap Schottky rectifiers suited for high frequency switch mode power supply.

Packaged in TO-220AB, TO-247 and D²PAK, this device is intended for use to enhance the reliability of the application.

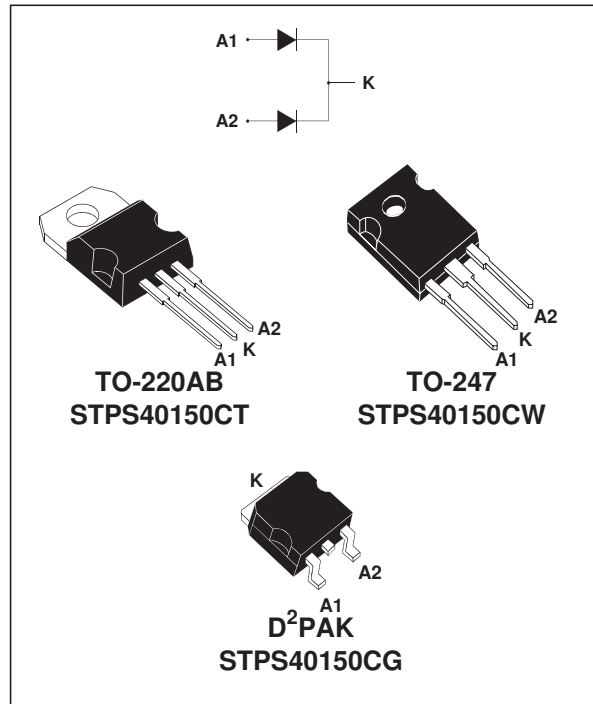

ABSOLUTE RATINGS (limiting values, per diode)

Symbol	Parameter		Value	Unit	
V_{RRM}	Repetitive peak reverse voltage		150	V	
$I_{F(RMS)}$	RMS forward current		60	A	
$I_{F(AV)}$	Average forward current	$T_c = 150^\circ\text{C}$	Per diode	20	A
		$\delta = 0.5$	Per device	40	A
I_{FSM}	Surge non repetitive forward current	$t_p = 10 \text{ ms}$ Sinusoidal	250	A	
P_{ARM}	Repetitive peak avalanche power	$t_p = 1 \mu\text{s}$ $T_j = 25^\circ\text{C}$	14100	W	
T_{stg}	Storage temperature range		- 65 to + 175	°C	
T_j	Maximum operating junction temperature *		175	°C	
dV/dt	Critical rate of rise of reverse voltage		10000	V/ μs	

* : $\frac{dP_{tot}}{dT_j} < \frac{1}{R_{th(j-a)}}$ thermal runaway condition for a diode on its own heatsink

STPS40150CT/CW/CG

THERMAL RESISTANCES

Symbol	Parameter		Value	Unit	
$R_{th(j-c)}$	Junction to case	TO-220AB / D ² PAK	Per diode Total	1.2 0.85	°C/W
		TO-247	Per diode Total	1.2 0.85	°C/W
$R_{th(c)}$			Coupling	0.5	°C/W

When the diodes 1 and 2 are used simultaneously :
 $\Delta T_j(\text{diode } 1) = P(\text{diode } 1) \times R_{th(j-c)}(\text{Per diode}) + P(\text{diode } 2) \times R_{th(c)}$

STATIC ELECTRICAL CHARACTERISTICS (per diode)

Symbol	Parameter	Tests Conditions		Min.	Typ.	Max.	Unit
I_R^*	Reverse leakage current	$T_j = 25^\circ\text{C}$	$V_R = V_{RRM}$		2	8	μA
		$T_j = 125^\circ\text{C}$			2	11	mA
V_F^*	Forward voltage drop	$T_j = 25^\circ\text{C}$	$I_F = 20\text{ A}$			0.92	V
		$T_j = 125^\circ\text{C}$	$I_F = 20\text{ A}$		0.69	0.75	
		$T_j = 25^\circ\text{C}$	$I_F = 40\text{ A}$			1.00	
		$T_j = 125^\circ\text{C}$	$I_F = 40\text{ A}$		0.79	0.86	

Pulse test : * $t_p = 380\ \mu\text{s}$, $\delta < 2\%$

To evaluate the conduction losses use the following equation :

$$P = 0.64 \times I_F(\text{AV}) + 0.0055 I_F^2(\text{RMS})$$

Fig. 1: Conduction losses versus average current (per diode).

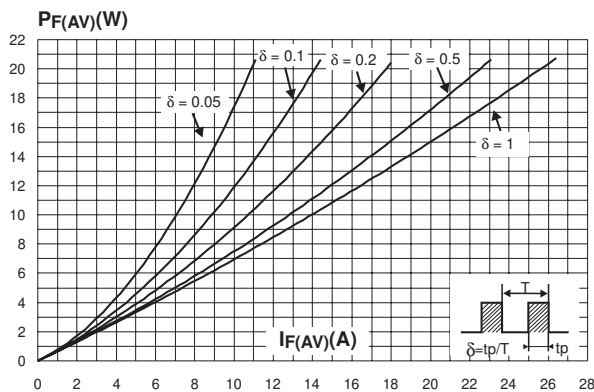

Fig. 2: Normalized avalanche power derating versus pulse duration.

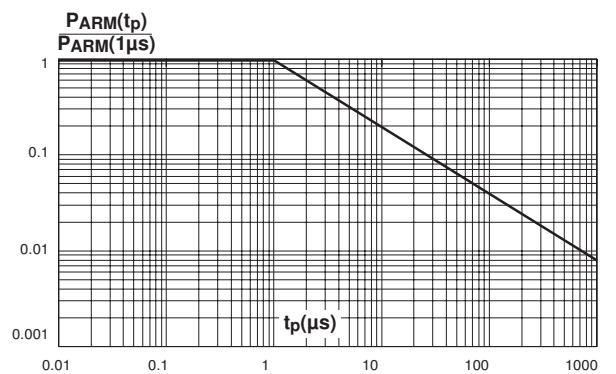

Fig. 3: Normalized avalanche power derating versus junction temperature.

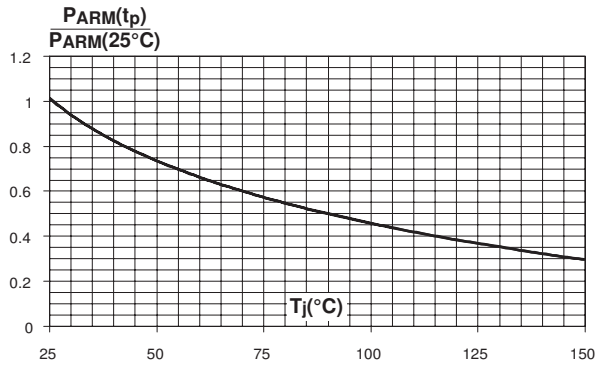

Fig. 4: Average forward current versus ambient temperature ($\delta=0.5$, per diode).

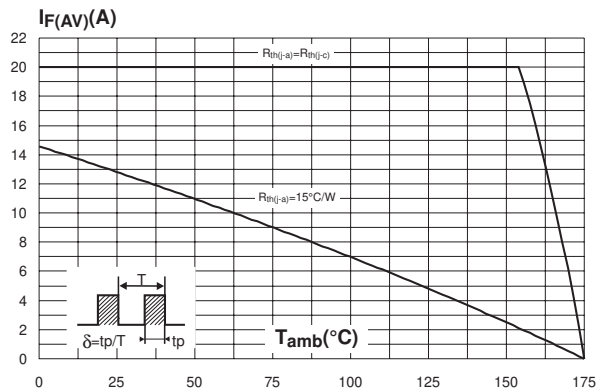

Fig. 5: Non repetitive surge peak forward current versus overload duration (maximum values, per diode).

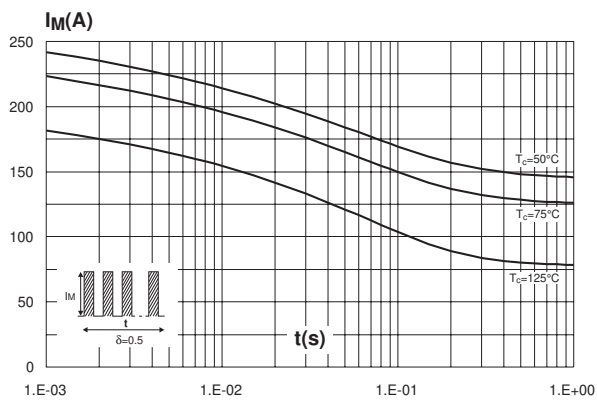

Fig. 6: Relative variation of thermal impedance junction to case versus pulse duration.

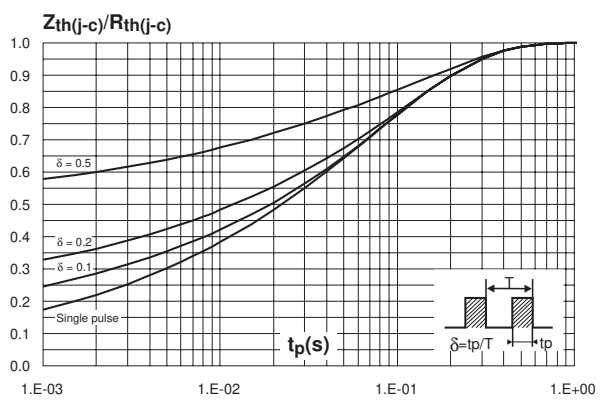

Fig. 7: Reverse leakage current versus reverse voltage applied (typical values, per diode).

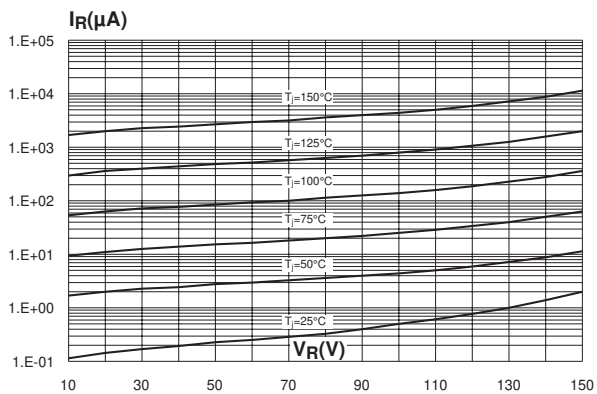

Fig. 8: Junction capacitance versus reverse voltage applied (typical values, per diode).

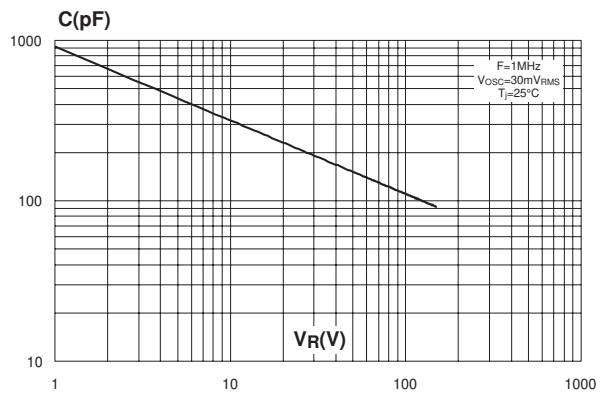

Fig. 9: Forward voltage drop versus forward current (per diode).

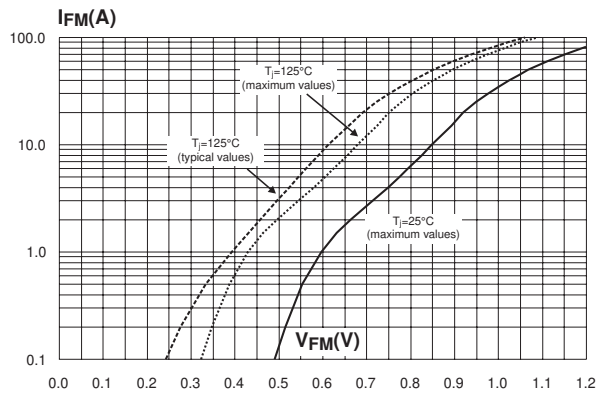
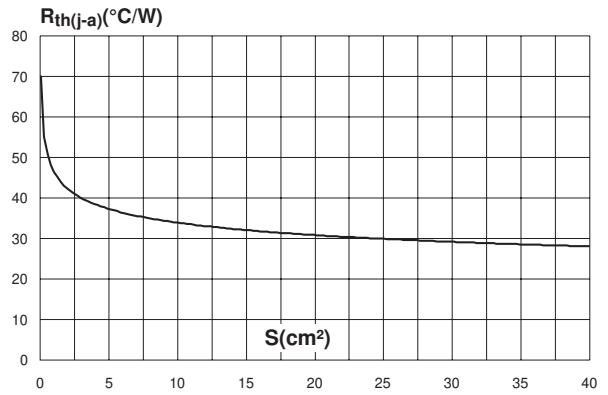

Fig. 10: Thermal resistance junction to ambient versus copper surface under tab (epoxy printed board FR4, Cu=35µm) (D²PAK).



PACKAGE MECHANICAL DATA
TO-220AB

REF.	DIMENSIONS			
	Millimeters		Inches	
	Min.	Max.	Min.	Max.
A	4.40	4.60	0.173	0.181
C	1.23	1.32	0.048	0.051
D	2.40	2.72	0.094	0.107
E	0.49	0.70	0.019	0.027
F	0.61	0.88	0.024	0.034
F1	1.14	1.70	0.044	0.066
F2	1.14	1.70	0.044	0.066
G	4.95	5.15	0.194	0.202
G1	2.40	2.70	0.094	0.106
H2	10	10.40	0.393	0.409
L2	16.4 typ.		0.645 typ.	
L4	13	14	0.511	0.551
L5	2.65	2.95	0.104	0.116
L6	15.25	15.75	0.600	0.620
L7	6.20	6.60	0.244	0.259
L9	3.50	3.93	0.137	0.154
M	2.6 typ.		0.102 typ.	
Diam.	3.75	3.85	0.147	0.151

- Cooling method : C
- Recommended torque value : 0.55 m.N
- Maximum torque value : 0.70 m.N

PACKAGE MECHANICAL DATA
D²PAK

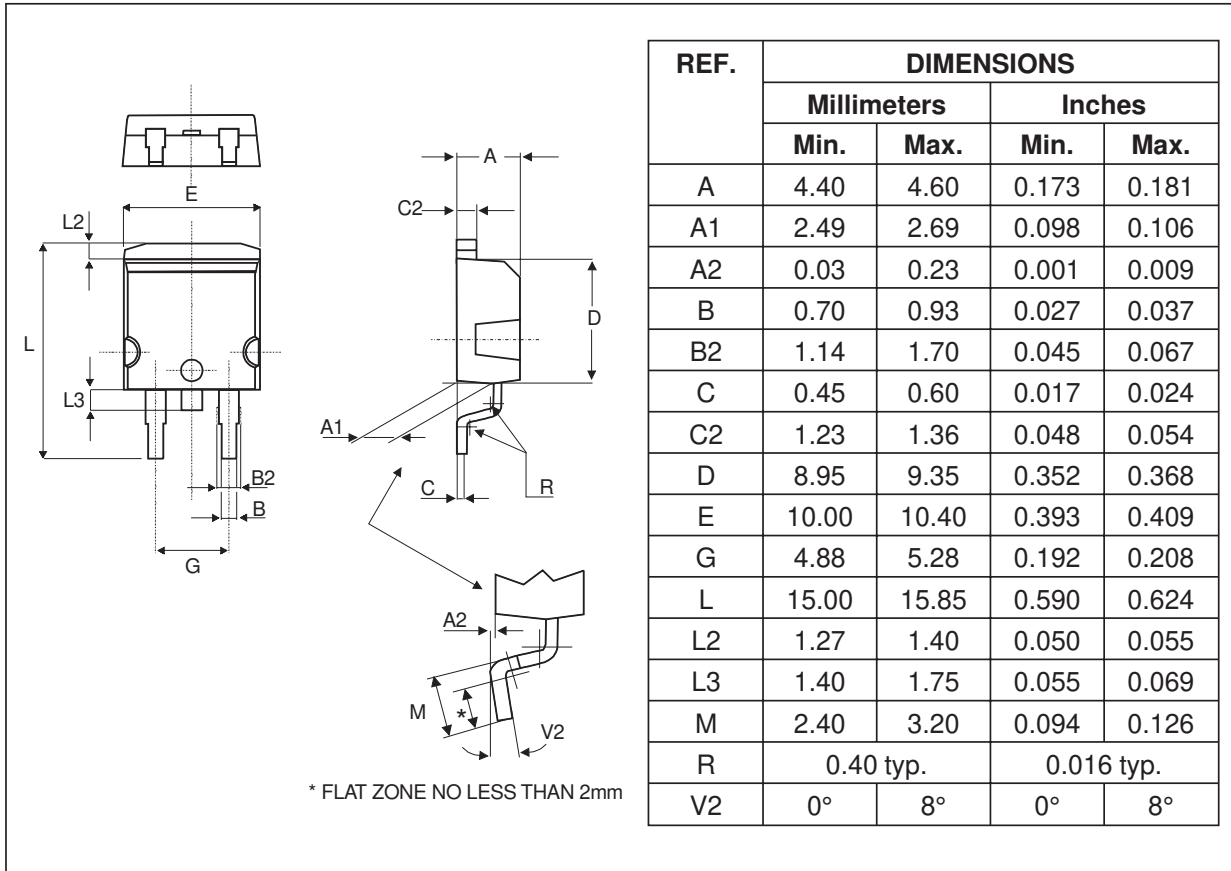

FOOT PRINT DIMENSIONS (in millimeters)

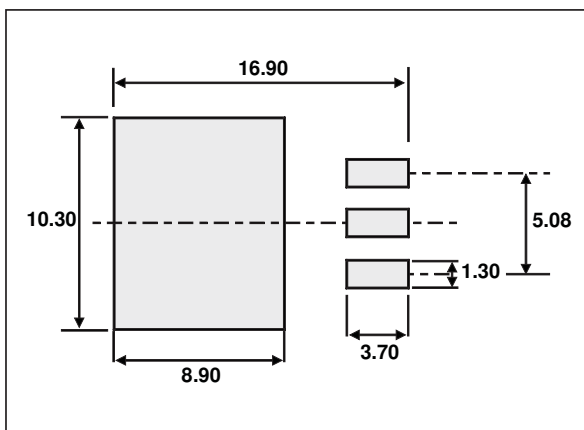

STPS40150CT/CW/CG

PACKAGE MECHANICAL DATA
TO-247

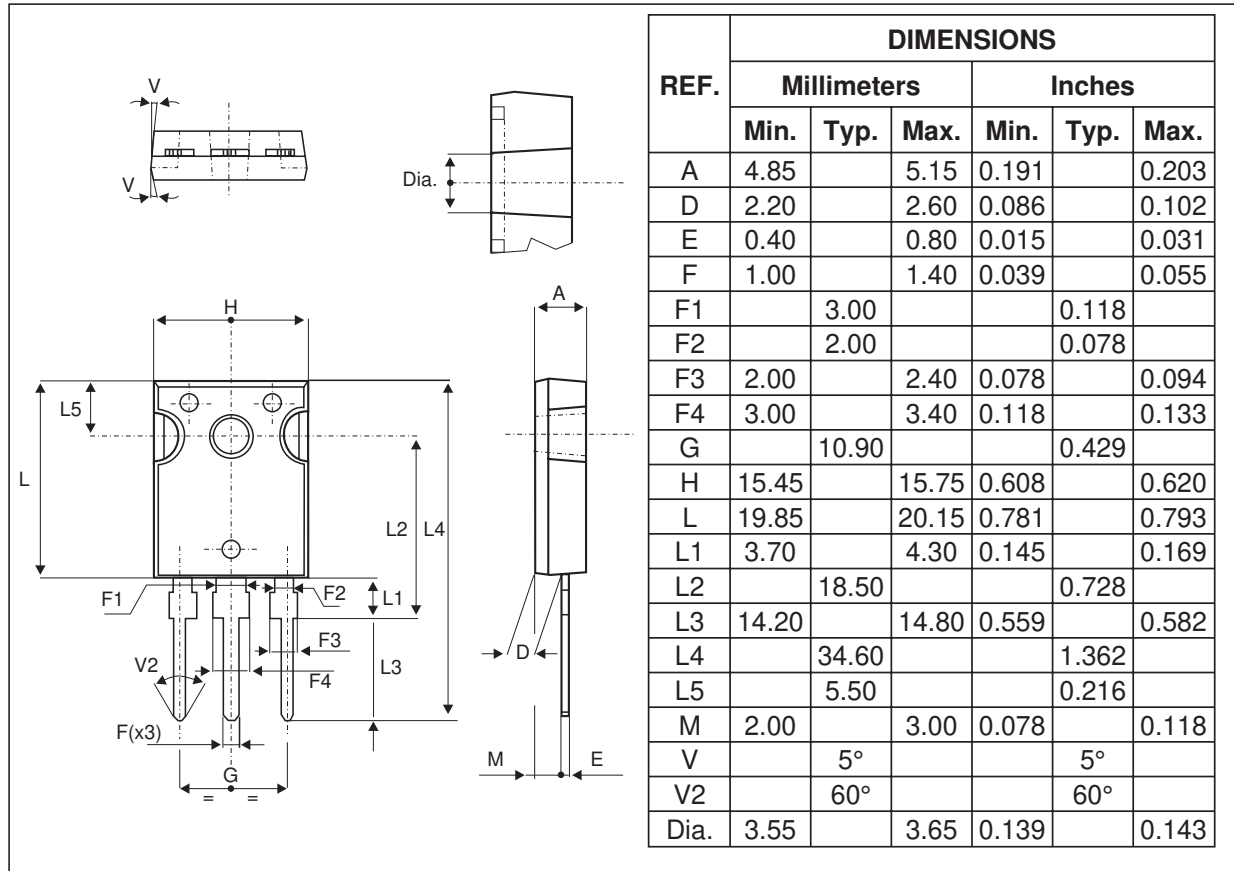

- Cooling method : C
- Recommended torque value : 0.8m.N
- Maximum torque value : 1.0m.N

Ordering type	Marking	Package	Weight	Base qty	Delivery mode
STPS40150CT	STPS40150CT	TO-220AB	2g	50	Tube
STPS40150CW	STPS40150CW	TO-247	4.4g	30	Tube
STPS40150CG	STPS40150CG	D ² PAK	1.48g	50	Tube
STPS40150CG-TR	STPS40150CG-TR	D ² PAK	1.48g	1000	Tape & reel

- Epoxy meets UL94,V0

Information furnished is believed to be accurate and reliable. However, STMicroelectronics assumes no responsibility for the consequences of use of such information nor for any infringement of patents or other rights of third parties which may result from its use. No license is granted by implication or otherwise under any patent or patent rights of STMicroelectronics. Specifications mentioned in this publication are subject to change without notice. This publication supersedes and replaces all information previously supplied. STMicroelectronics products are not authorized for use as critical components in life support devices or systems without express written approval of STMicroelectronics.

The ST logo is a registered trademark of STMicroelectronics.

All other names are the property of their respective owners.

© 2003 STMicroelectronics - All rights reserved.

STMicroelectronics GROUP OF COMPANIES

Australia - Belgium - Brazil - Canada - China - Czech Republic - Finland - France - Germany - Hong Kong - India - Israel - Italy - Japan - Malaysia - Malta - Morocco - Singapore - Spain - Sweden - Switzerland - United Kingdom - United States

www.st.com

