



Chipsmall Limited consists of a professional team with an average of over 10 year of expertise in the distribution of electronic components. Based in Hongkong, we have already established firm and mutual-benefit business relationships with customers from,Europe,America and south Asia,supplying obsolete and hard-to-find components to meet their specific needs.

With the principle of “Quality Parts,Customers Priority,Honest Operation,and Considerate Service”,our business mainly focus on the distribution of electronic components. Line cards we deal with include Microchip,ALPS,ROHM,Xilinx,Pulse,ON,Everlight and Freescale. Main products comprise IC,Modules,Potentiometer,IC Socket,Relay,Connector.Our parts cover such applications as commercial,industrial, and automotives areas.

We are looking forward to setting up business relationship with you and hope to provide you with the best service and solution. Let us make a better world for our industry!



Contact us

Tel: +86-755-8981 8866 Fax: +86-755-8427 6832

Email & Skype: info@chipsmall.com Web: www.chipsmall.com

Address: A1208, Overseas Decoration Building, #122 Zhenhua RD., Futian, Shenzhen, China



650 V power Schottky silicon carbide diode

Datasheet - production data

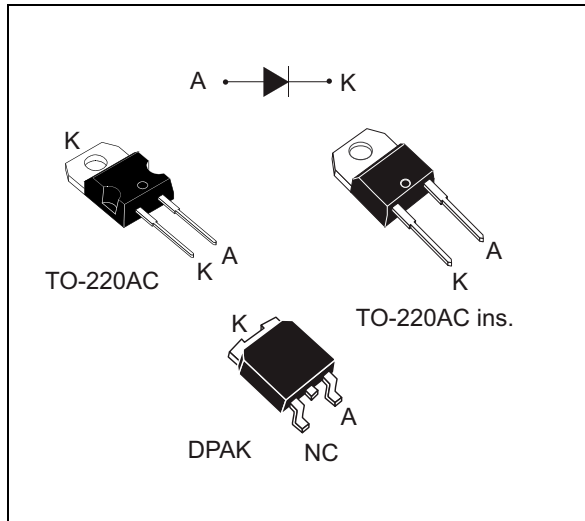

Description

The SiC diode is an ultrahigh performance power Schottky diode. It is manufactured using a silicon carbide substrate. The wide band gap material allows the design of a Schottky diode structure with a 650 V rating. Due to the Schottky construction, no recovery is shown at turn-off and ringing patterns are negligible. The minimal capacitive turn-off behavior is independent of temperature.

Especially suited for use in PFC applications, this ST SiC diode will boost the performance in hard switching conditions. Its high forward surge capability ensures a good robustness during transient phases.

Features

- No reverse recovery charge in application current range
- Switching behavior independent of temperature
- High forward surge capability
- Insulated package TO-220AC Ins:
 - Insulated voltage: 2500 V rms
 - Typical package capacitance: 7 pF

Table 1. Device summary

Symbol	Value
$I_{F(AV)}$	4 A
V_{RRM}	650 V
T_j (max)	175 °C

1 Characteristics

Table 2. Absolute ratings (limiting values at 25 °C unless otherwise specified)

Symbol	Parameter		Value	Unit
V _{RRM}	Repetitive peak reverse voltage		650	V
I _{F(RMS)}	Forward rms current		22	A
I _{F(AV)}	Average forward current	TO-220AC, DPAK, T _c = 145 °C ⁽¹⁾ , DC	4	A
		TO-220AC Ins, T _c = 125 °C ⁽¹⁾ , DC		
I _{FSM}	Surge non repetitive forward current	t _p = 10 ms sinusoidal, T _c = 25 °C	38	A
		t _p = 10 ms sinusoidal, T _c = 125 °C	35	
		t _p = 10 μs square, T _c = 25 °C	200	
I _{FRM}	Repetitive peak forward current	TO-220AC, DPAK, T _c = 145 °C ⁽¹⁾ , T _j = 175 °C, δ = 0.1	17	A
		TO-220AC Ins, T _c = 125 °C ⁽¹⁾ , T _j = 175 °C, δ = 0.1		
T _{stg}	Storage temperature range		-55 to +175	°C
T _j	Operating junction temperature ⁽²⁾		-40 to +175	°C

1. Value based on R_{th(j-c)} max.
2. $\frac{dP_{tot}}{dT_j} < \frac{1}{R_{th(j-a)}}$ condition to avoid thermal runaway for a diode on its own heatsink

Table 3. Thermal resistance

Symbol	Parameter	Typ. value	Max. value	Unit	
R _{th(j-c)}	Junction to case	TO-220AC, DPAK	1.8	2.7	°C/W
		TO-220AC Ins	3	4.5	

Table 4. Static electrical characteristics

Symbol	Parameter	Tests conditions		Min.	Typ.	Max.	Unit
I _R ⁽¹⁾	Reverse leakage current	T _j = 25 °C	V _R = V _{RRM}	-	3	40	μA
		T _j = 150 °C		-	35	170	
V _F ⁽²⁾	Forward voltage drop	T _j = 25 °C	I _F = 4 A	-	1.56	1.75	V
		T _j = 150 °C		-	1.98	2.5	

1. t_p = 10 ms, δ < 2%
2. t_p = 500 μs, δ < 2%

To evaluate the conduction losses use the following equation: $P = 1.35 \times I_{F(AV)} + 0.288 \times I_{F(RMS)}^2$

Table 5. Dynamic electrical characteristics

Symbol	Parameter	Test conditions	Min.	Typ.	Unit
$Q_{cj}^{(1)}$	Total capacitive charge	$V_R = 400\text{ V}$		12.5	nC
C_j	Total capacitance	$V_R = 0\text{ V}, T_C = 25\text{ }^\circ\text{C}, F = 1\text{ MHz}$		200	pF
		$V_R = 400\text{ V}, T_C = 25\text{ }^\circ\text{C}, F = 1\text{ MHz}$		21	

1. Most accurate value for the capacitive charge: $Q_{cj} = \int_0^{V_{OUT}} C_j(V_R).dV_R$

Figure 1. Forward voltage drop versus forward current (typical values, low level)

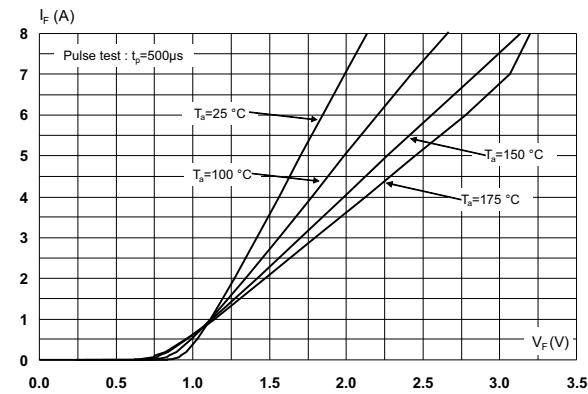

Figure 2. Forward voltage drop versus forward current (typical values, high level)

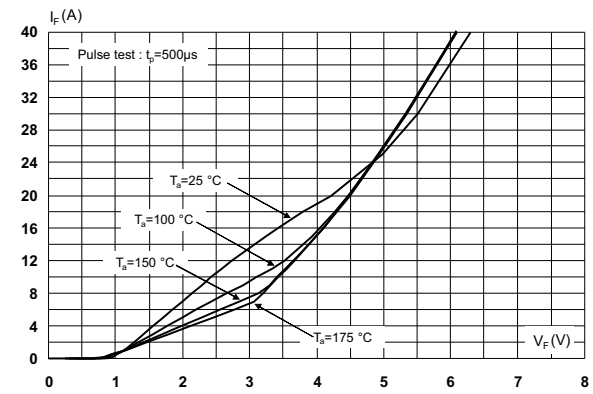

Figure 3. Reverse leakage current versus reverse voltage applied (typical values)

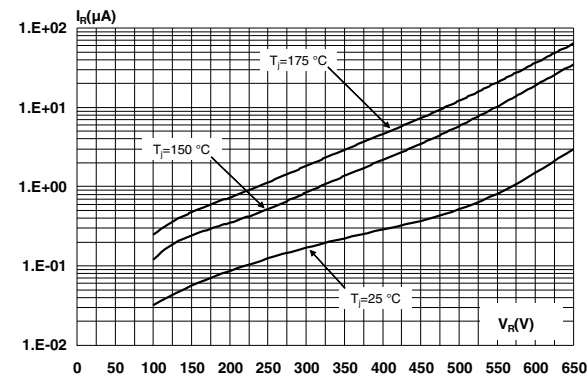

Figure 4. Peak forward current versus case temperature (TO-220AC and DPAK)

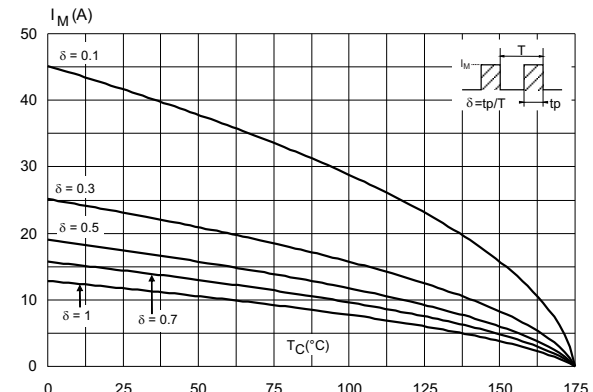

Figure 5. Peak forward current versus case temperature (TO-220AC Ins)

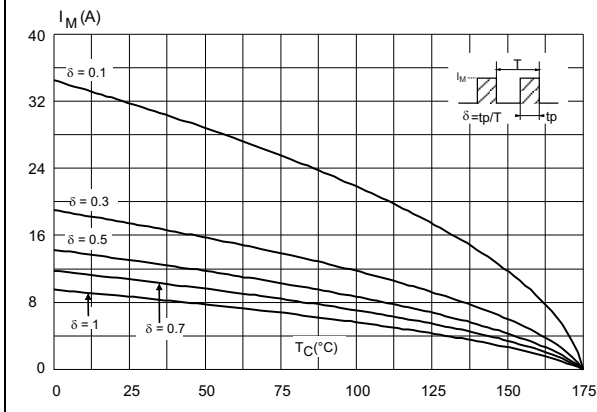

Figure 6. Junction capacitance versus reverse voltage applied (typical values)

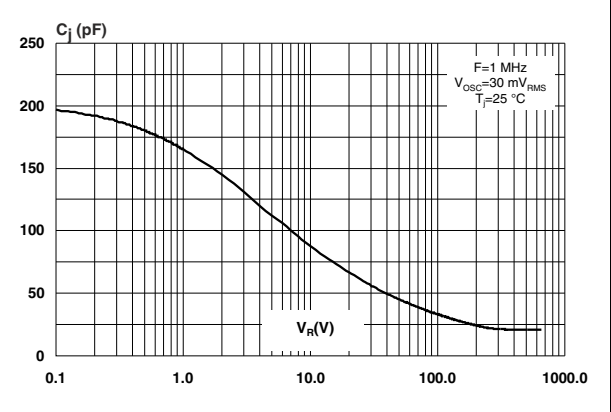

Figure 7. Relative variation of thermal impedance junction to case versus pulse duration (TO-220AC and DPAK)

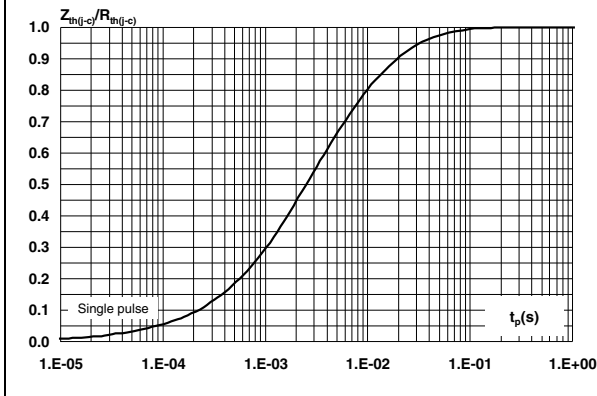

Figure 8. Relative variation of thermal impedance junction to case versus pulse duration (TO-220AC Ins)

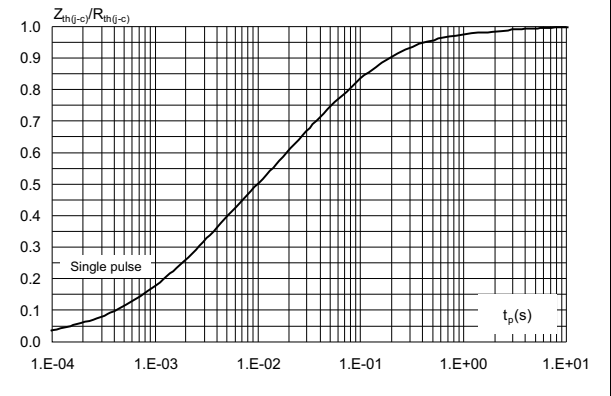

Figure 9. Non-repetitive peak surge forward current versus pulse duration (sinusoidal waveform)

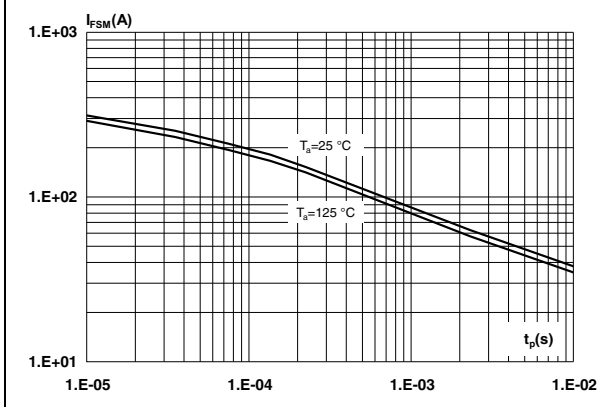
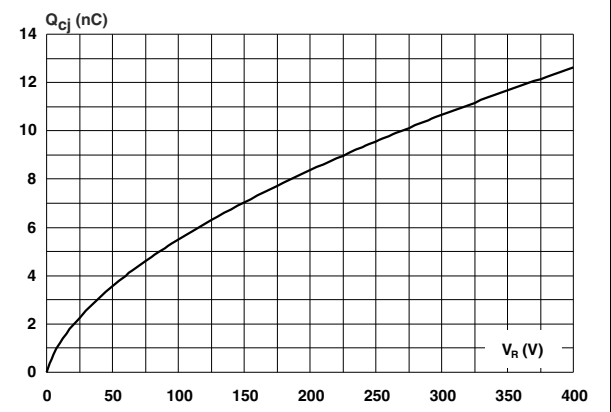

Figure 10. Total capacitive charges versus reverse voltage applied (typical values)



2 Package information

- Epoxy meets UL94, V0
- Recommended torque value: 0.55 N·m
- Maximum torque value: 0.7 N·m
- Cooling method: conduction (C)

In order to meet environmental requirements, ST offers these devices in different grades of ECOPACK[®] packages, depending on their level of environmental compliance. ECOPACK[®] specifications, grade definitions and product status are available at: www.st.com. ECOPACK[®] is an ST trademark.

2.1 TO-220AC package information

Figure 11. TO-220AC package outline

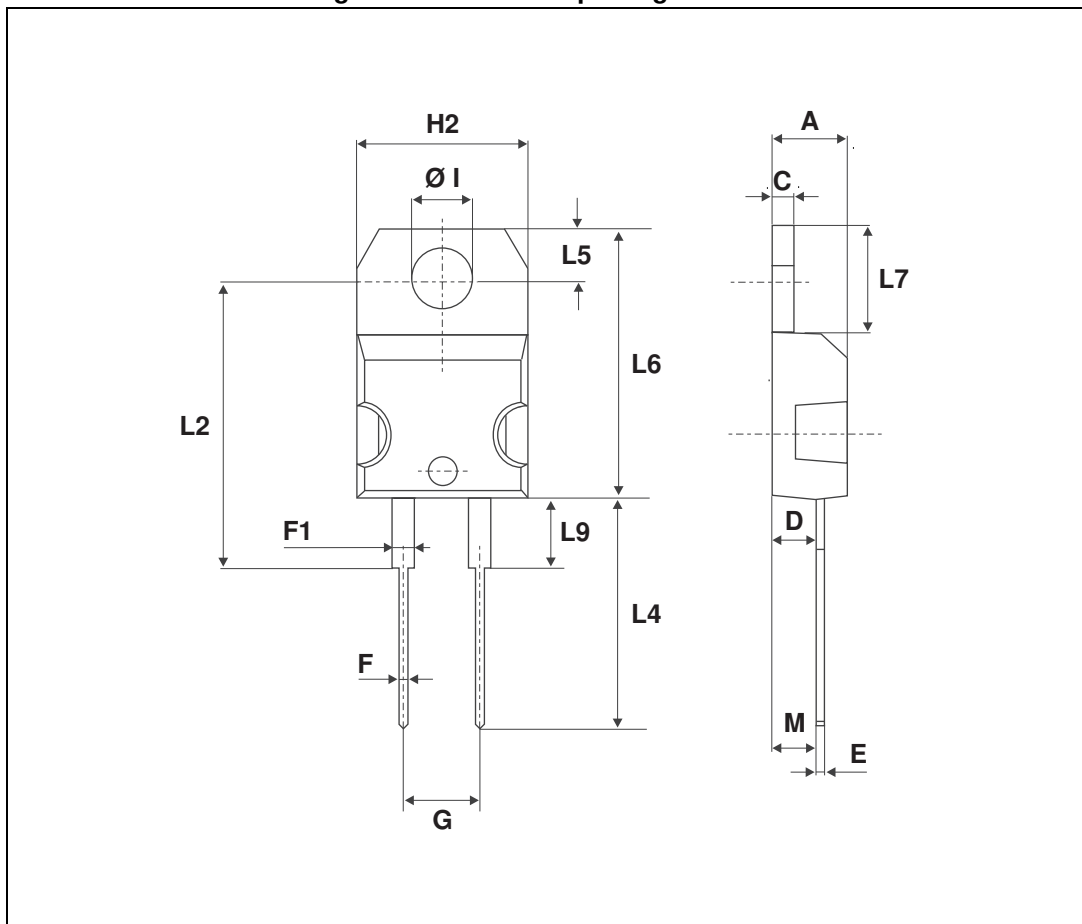

Table 6. TO-220AC package mechanical data

Ref.	Dimensions			
	Millimeters		Inches	
	Min.	Max.	Min.	Max.
A	4.40	4.60	0.173	0.181
C	1.23	1.32	0.048	0.051
D	2.40	2.72	0.094	0.107
E	0.49	0.70	0.019	0.027
F	0.61	0.88	0.024	0.034
F1	1.14	1.70	0.044	0.066
G	4.95	5.15	0.194	0.202
H2	10.00	10.40	0.393	0.409
L2	16.40 typ.		0.645 typ.	
L4	13.00	14.00	0.511	0.551
L5	2.65	2.95	0.104	0.116
L6	15.25	15.75	0.600	0.620
L7	6.20	6.60	0.244	0.259
L9	3.50	3.93	0.137	0.154
M	2.6 typ.		0.102 typ.	
Diam. I	3.75	3.85	0.147	0.151

2.2 TO-220AC ins package information

Figure 12. TO-220AC Ins package outline

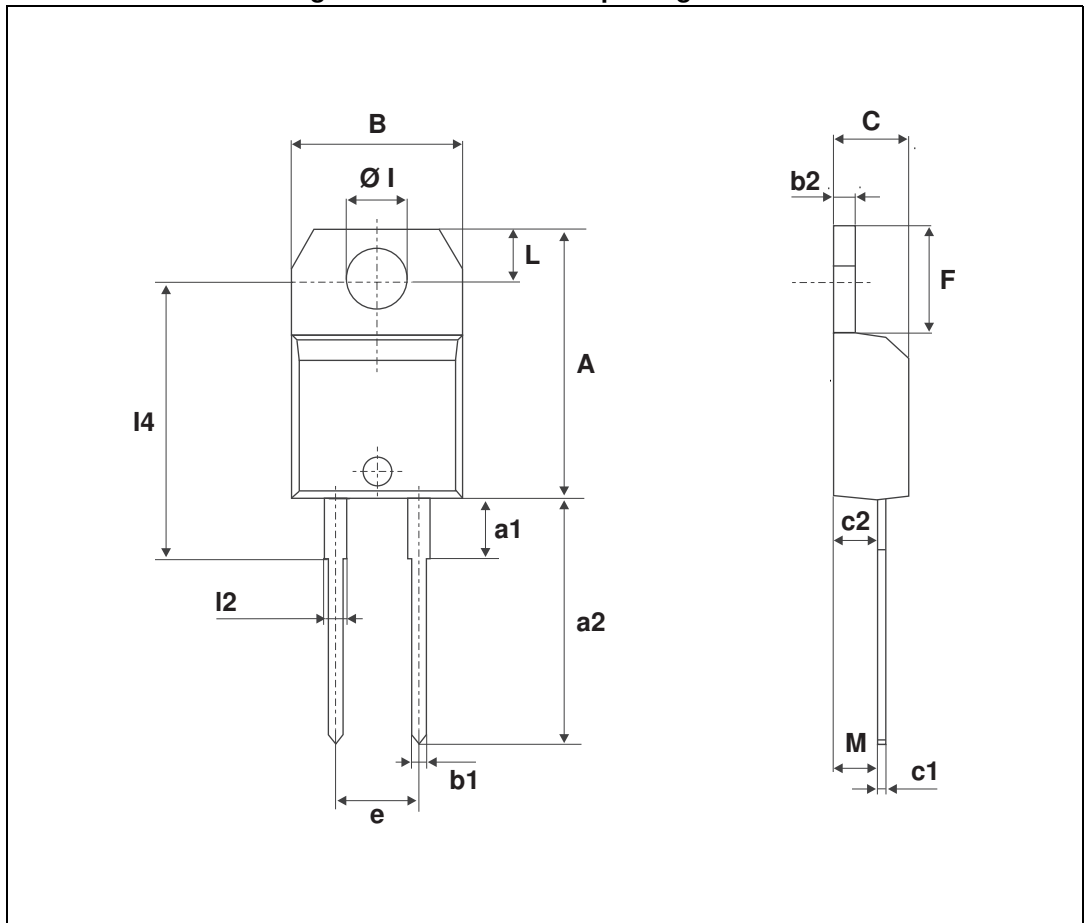

Table 7. TO-220AC Ins package mechanical data

Ref.	Dimensions					
	Millimeters			Inches		
	Min.	Typ.	Max.	Min.	Typ.	Max.
A	15.20		15.90	0.598		0.625
a1		3.75			0.147	
a2	13.00		14.00	0.511		0.551
B	10.00		10.40	0.393		0.409
b1	0.61		0.88	0.024		0.034
b2	1.23		1.32	0.048		0.051
C	4.40		4.60	0.173		0.181
c1	0.49		0.70	0.019		0.027
c2	2.40		2.72	0.094		0.107
e	4.80		5.40	0.189		0.212
F	6.20		6.60	0.244		0.259
ØI	3.75		3.85	0.147		0.151
I4	15.80	16.40	16.80	0.622	0.646	0.661
L	2.65		2.95	0.104		0.116
I2	1.14		1.70	0.044		0.066
M		2.60			0.102	

2.3 DPAK package information

Figure 13. DPAK package outline

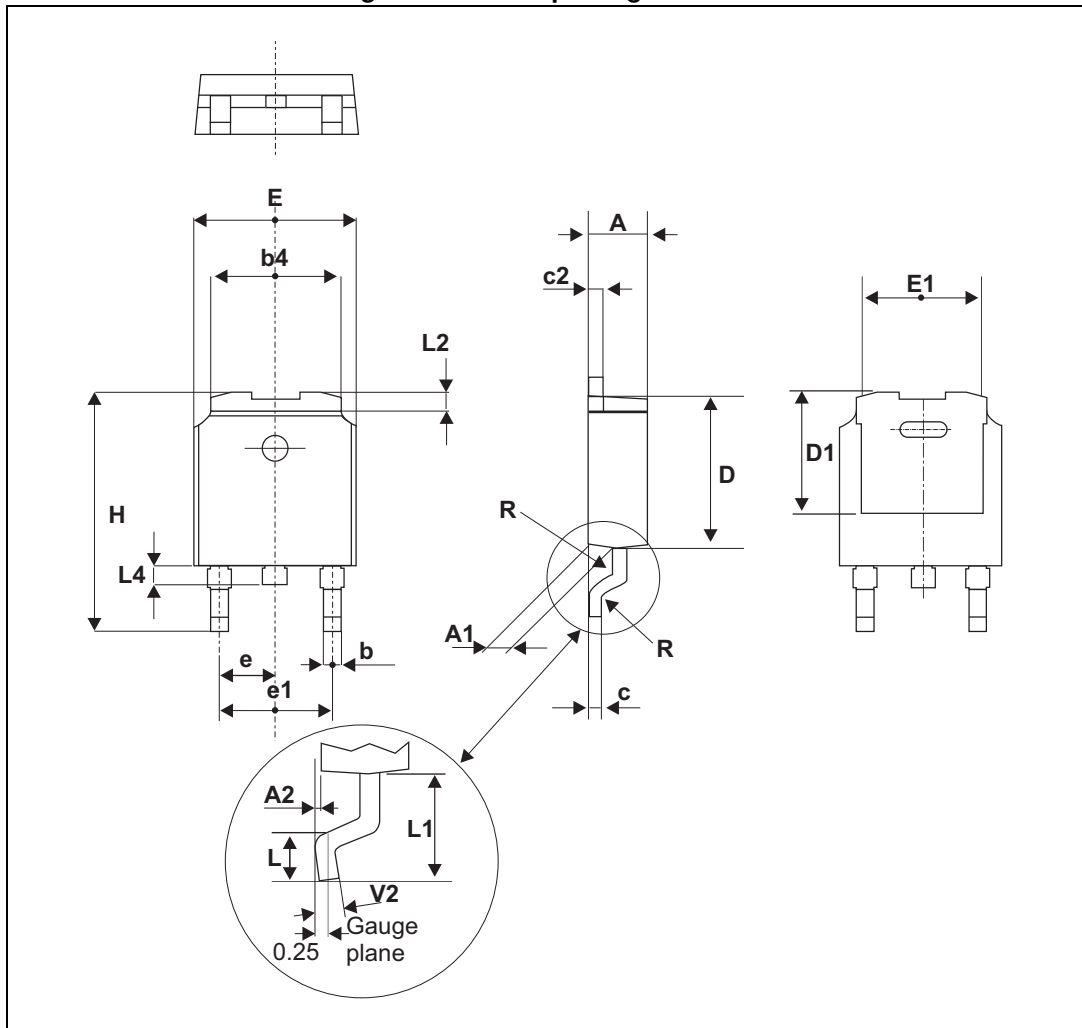
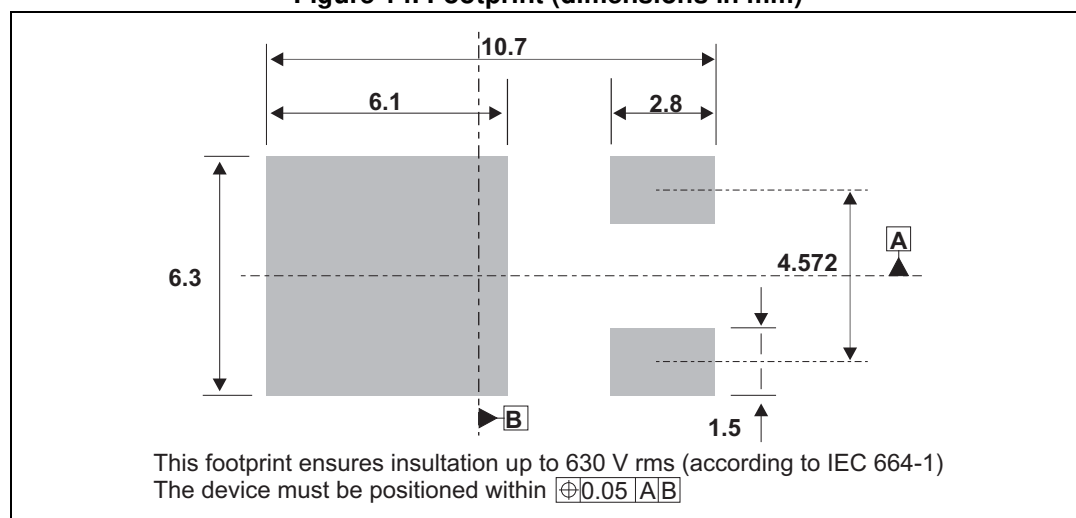

Table 8. DPAK package mechanical data

Ref.	Dimensions					
	Millimeters			Inches		
	Min.	Typ.	Max.	Min.	Typ.	Max.
A	2.20		2.40	0.086		0.094
A1	0.90		1.10	0.035		0.043
A2	0.03		0.23	0.001		0.009
b	0.64		0.90	0.025		0.035
b4	5.20		5.40	0.204		0.212
c	0.45		0.60	0.017		0.023
c2	0.48		0.60	0.018		0.023
D	6.00		6.20	0.236		0.244
D1		5.10			0.201	
E	6.40		6.60	0.251		0.259
E1		4.70			0.185	
e		2.28			0.090	
e1	4.40		4.60	0.173		0.181
H	9.35		10.10	0.368		0.397
L	1.00		1.50	0.039		0.059
L1		2.80			0.11	
L2		0.80			0.032	
L4	0.60		1.00	0.023		0.039
R		0.2			0.008	
V2	0°		8°	0°		8°

Figure 14. Footprint (dimensions in mm)



3 Ordering information

Table 9. Ordering information

Order code	Marking	Package	Weight	Base qty	Delivery mode
STPSC4H065D	STPSC4H065D	TO-220AC	1.86 g	50	Tube
STPSC4H065DI	STPSC 4H065DI	TO-220AC Ins	2.12 g	50	Tube
STPSC4H065B-TR	STPSC 4H065	DPAK	0.32 g	2500	Tape and reel

4 Revision history

Table 10. Document revision history

Date	Revision	Changes
31-Aug-2012	1	First issue.
10-Oct-2012	2	Added Max. value in Table 3 .
07-Nov-2013	3	Updated Figure 1 , Figure 2 , Figure 13 , Figure 14 and Table 8 .
07-Jan-2014	4	Added TO-220AC Ins package.
15-Jul-2015	5	Updated Table 9 .

IMPORTANT NOTICE – PLEASE READ CAREFULLY

STMicroelectronics NV and its subsidiaries ("ST") reserve the right to make changes, corrections, enhancements, modifications, and improvements to ST products and/or to this document at any time without notice. Purchasers should obtain the latest relevant information on ST products before placing orders. ST products are sold pursuant to ST's terms and conditions of sale in place at the time of order acknowledgement.

Purchasers are solely responsible for the choice, selection, and use of ST products and ST assumes no liability for application assistance or the design of Purchasers' products.

No license, express or implied, to any intellectual property right is granted by ST herein.

Resale of ST products with provisions different from the information set forth herein shall void any warranty granted by ST for such product.

ST and the ST logo are trademarks of ST. All other product or service names are the property of their respective owners.

Information in this document supersedes and replaces information previously supplied in any prior versions of this document.

© 2015 STMicroelectronics – All rights reserved