



Chipsmall Limited consists of a professional team with an average of over 10 year of expertise in the distribution of electronic components. Based in Hongkong, we have already established firm and mutual-benefit business relationships with customers from,Europe,America and south Asia,supplying obsolete and hard-to-find components to meet their specific needs.

With the principle of "Quality Parts,Customers Priority,Honest Operation,and Considerate Service",our business mainly focus on the distribution of electronic components. Line cards we deal with include Microchip,ALPS,ROHM,Xilinx,Pulse,ON,Everlight and Freescale. Main products comprise IC,Modules,Potentiometer,IC Socket,Relay,Connector.Our parts cover such applications as commercial,industrial, and automotives areas.

We are looking forward to setting up business relationship with you and hope to provide you with the best service and solution. Let us make a better world for our industry!



Contact us

Tel: +86-755-8981 8866 Fax: +86-755-8427 6832

Email & Skype: info@chipsmall.com Web: www.chipsmall.com

Address: A1208, Overseas Decoration Building, #122 Zhenhua RD., Futian, Shenzhen, China



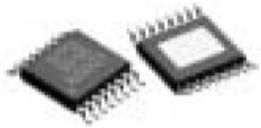

RFMD Green, RoHS Compliant, Pb-Free (Z Part Number)
Package: TSSOP, 16-Pin, 5.0mmx6.4mmx1.0mm

Product Description

RFMD's STQ-3016 is a direct quadrature modulator targeted for use in a wide range of communications systems. This device features a wide 2500MHz to 4000MHz operating frequency band, excellent carrier and sideband suppression, and a low broadband noise floor.

The STQ-3016 uses silicon germanium (SiGe) device technology and delivers a typical output power of -12dBm with greater than 50dB IM3 suppression. The device is packaged in an industry standard 16-pin TSSOP with exposed paddle for superb RF and thermal ground.

Optimum Technology Matching® Applied

- GaAs HBT
- GaAs MESFET
- InGaP HBT
- SiGe BiCMOS
- Si BiCMOS
- SiGe HBT
- GaAs pHEMT
- Si CMOS
- Si BJT
- GaN HEMT
- RF MEMS

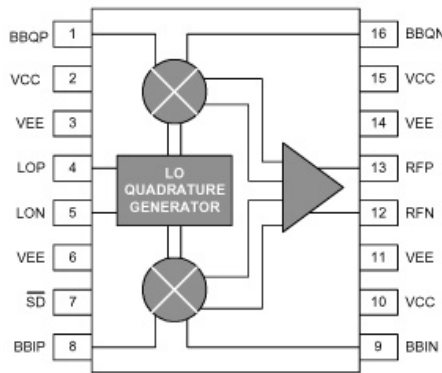

Features

- Excellent Carrier Feedthrough, -40dBm
- Wide Baseband Input, DC to 500MHz
- Superb Phase Accuracy and Amplitude Balance, $\pm 4^\circ / \pm 0.2\text{dB}$
- No External IF Filter Required
- Very Low Noise Floor, -153dBm/Hz
- Low LO Drive Requirement, -6dBm
- Single +5V Supply with Digital Shut-Down

Applications

- 2.5GHz and 3.5GHz Fixed Wireless Communication Systems
- GMSK, QPSK, QAM, SSB Modulators

Parameter	Unit	2500MHz to 3000MHz			3000MHz to 4000MHz			Condition
		Min.	Typ.	Max.	Min.	Typ.	Max.	
RF Output: T_A = 25° C								
RF Frequency Range	MHz	2500		3000	3000		4000	
Output Power	dBm	-14	-11	-10	-15	-12	-10	
RF Port Return Loss	dB		15			10		Matched to 50Ω (Refer to schematics on page 6 and 7)
Output P1dB	dBm	-1	+2		-1	+2		
Carrier Feedthrough	dB		-42	-32		-42	-32	
Sideband Suppression	dBm	30	36		28	33		
IM3 Suppression	dB	50	55		50	55		Two-tone baseband input @ 600mV _{p-p} differential per tone
Broadband Noise Floor	dBm/Hz		-154			-153		Baseband inputs tied to 1.9V _{DC} , -20MHz offset from carrier
Quadrature Phase Error	°C	-4.0	±2.0	+4.0	-4.0	±2.5	+4.0	
I/Q Amplitude Balance	dB	-0.2	±0.1	+0.2	-0.2	±0.1	+0.2	
Supply Voltage (V _{CC})	V	+4.75	+5.00	+5.25	+4.75	+5.00	+5.25	
Supply Current	mA		80	88		80	88	
Device Thermal Resistance	°C/W		25			25		Junction to case

Test Conditions (for all product specification tables unless otherwise noted): V_{CC} (pins 2, 10, 15) = +5V, T_A = +25° C, Baseband Input (Pins 1, 8, 9, 16) = 1.9V DC bias, 200kHz frequency, 300mV_{p-p} differential drive, I and Q signals in quadrature, LO Input (Pins 4, 5) = -6dBm @ 3500MHz

Absolute Maximum Ratings

Parameter	Rating	Unit
Supply Voltage (VCC)	6.0	VCC
LO, Input (LOP, LON, RFP, RFN)	+10	dBm
Baseband Min Input Voltage (BBIP, BBIN, BBQP, BBQN)	0	VDC
Baseband Max Input Voltage (BBIP, BBIN, BBQP, BBQN)	3	VDC
Operating Temperature	-40 to +85	°C
Storage Temperature	-65 to +150	°C

Operation of this device beyond any one of these limits may cause permanent damage. For reliable continuous operation, the device voltage and current must not exceed the maximum operating values specified in the table on page one.



Caution! ESD sensitive device.

Exceeding any one or a combination of the Absolute Maximum Rating conditions may cause permanent damage to the device. Extended application of Absolute Maximum Rating conditions to the device may reduce device reliability. Specified typical performance or functional operation of the device under Absolute Maximum Rating conditions is not implied.

RoHS status based on EU Directive 2002/95/EC (at time of this document revision).

The information in this publication is believed to be accurate and reliable. However, no responsibility is assumed by RF Micro Devices, Inc. ("RFMD") for its use, nor for any infringement of patents, or other rights of third parties, resulting from its use. No license is granted by implication or otherwise under any patent or patent rights of RFMD. RFMD reserves the right to change component circuitry, recommended application circuitry and specifications at any time without prior notice.

Parameter	Specification			Unit	Condition
	Min.	Typ.	Max.		
Product Specifications					
Baseband Modulation Input	Baseband Modulation Input: $T_A = 25^\circ\text{C}$				
Baseband Frequency Input	DC		500	MHz	-3 dB bandwidth, baseband inputs terminated in 50Ω
Baseband Input Resistance		4.4		kΩ	per pin
Baseband Input Capacitance		0.5		pF	per pin
Product Specifications					
LO Input	LO Input: $T_A = 25^\circ\text{C}$				
Useable LO Frequency	2500		4000	MHz	
LO Drive Level	-9	-6	-3	dBm	
LO Port Return Loss		16		dB	Matched to 50Ω (refer to schematics)
Product Specifications					
Miscellaneous	Miscellaneous: $T_A = 25^\circ\text{C}$				
Shut-Down Attenuation		60		dB	
Shut-Down Pin Resistance		6.1		kΩ	at 1MHz
Shut-Down Pin Capacitance		0.7		pF	at 1MHz
Shut-Down Control Voltage Thresholds	4.0		V_{CC}	V	Shut-Down disabled (normal operation)
Shut-Down Control Voltage Thresholds	0.0		1.0	V	Shut-Down enabled
Shut-Down Settling Time		<450		ns	
Test Conditions: (for all product specifications unless otherwise noted) V_{CC} (pins 2, 10, 15): +5V, $T_A = +25^\circ\text{C}$, Baseband Input (pins 1, 8, 9, 16): 1.9V DC bias, 200kHz frequency; 300mVp-p per pin=600mVp-p differential drive, I and Q signals in quadrature, LO Input (pins 4, 5)=-6 dBm at 3500MHz					

2500MHz to 3000MHz Typical Device Performance

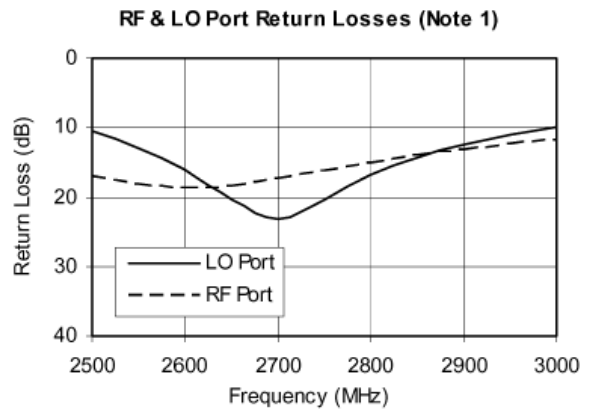
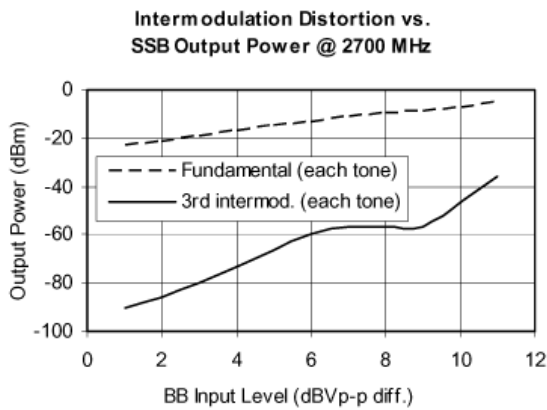
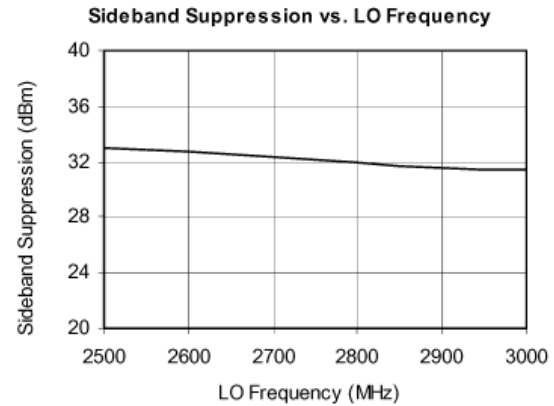
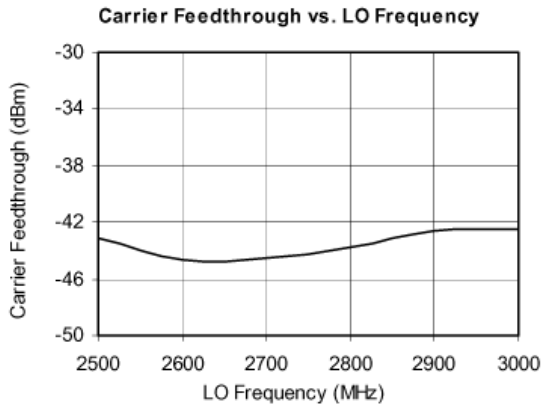
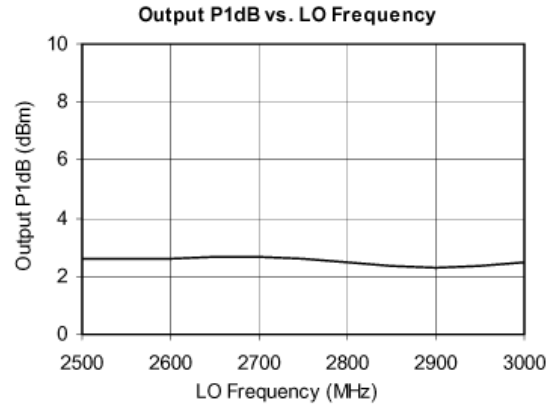
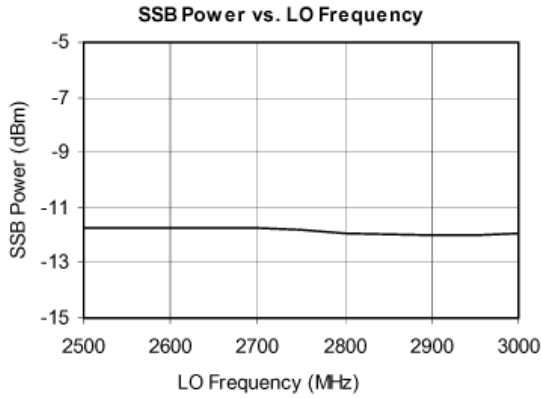

Note 1:

The return losses shown were measured with the STQ-3016 mounted on our FR4 evaluation boards using standard matching practices as indicated on the application schematic page (6) herein. Users following the RF, LO and IF matching guidelines will achieve similar performance.

3000MHz to 4000MHz Typical Device Performance

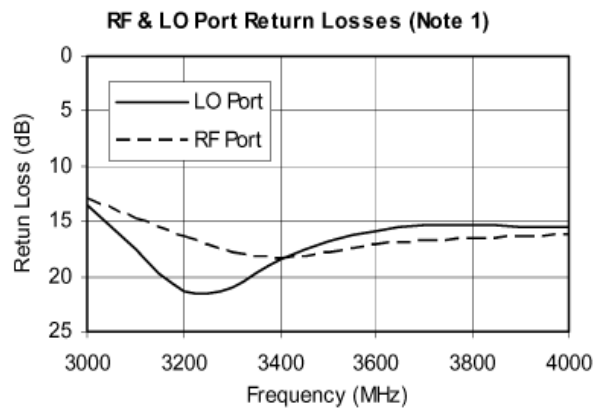
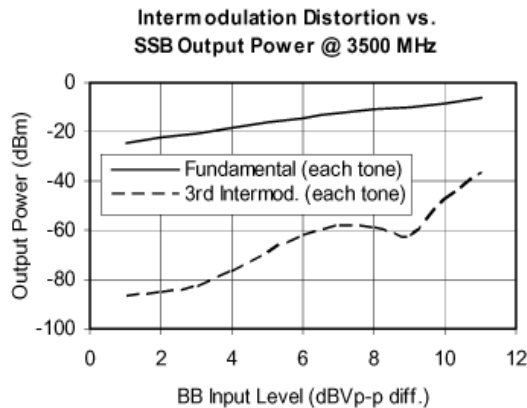
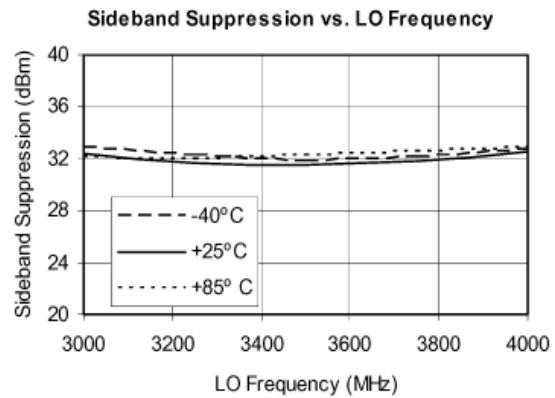
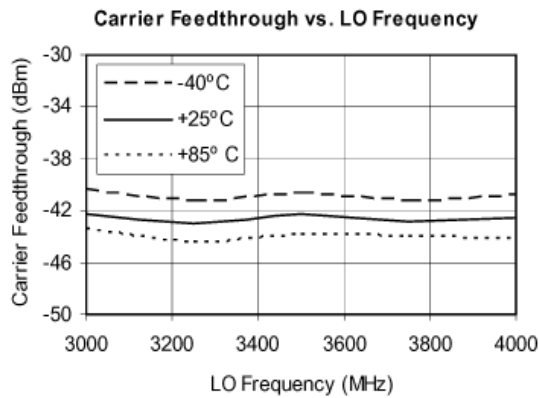
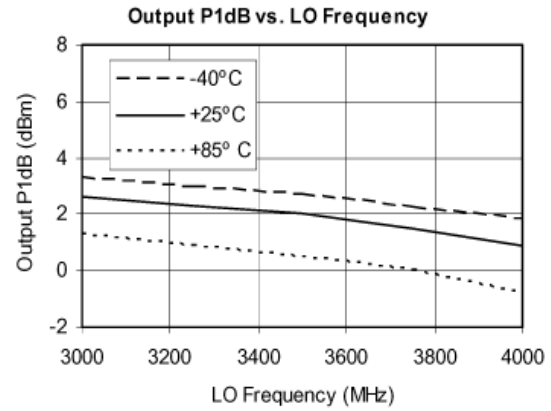
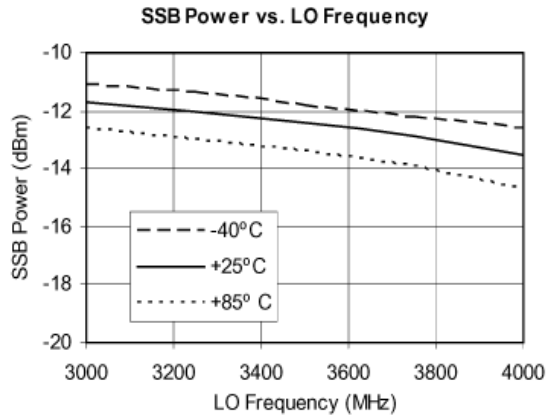

Note 1:

The return losses shown were measured with the STQ-3016 mounted on our FR4 evaluation boards using standard matching practices as indicated on the application schematic page (7) herein. Users following the RF, LO and IF matching guidelines will achieve similar performance.

Pin	Function	Description
1	BBQP	Q-channel baseband input, positive terminal. Nominal DC voltage is 1.9V (biased internally).
2, 10, 15	VCC	Positive supply (+5V).
3, 6, 11, 14	VEE	Ground.
4	LOP	Local oscillator input, positive terminal. Nominal DC voltage is 2.0V. Input should be AC-coupled.
5	LON	Local oscillator input, negative terminal. Nominal DC voltage is 2.0V. Input should be AC-coupled.
7	SD	Shut-down control. Logic high=normal operation; logic low=shut-down enabled.
8	BBIP	I-channel baseband input, positive terminal. Nominal DC bias voltage is 1.9V (biased internally).
9	BBIN	I-channel baseband input, negative terminal. Nominal DC bias voltage is 1.9V (biased internally).
12	RFN	RF output, negative terminal. Nominal DC voltage is 2.4V. Output should be AC-coupled.
13	RFP	RF output, positive terminal. Nominal DC voltage is 2.4V. Output should be AC-coupled.
16	BBQN	Q-channel baseband input, negative terminal. Nominal DC bias voltage is 1.9V (biased internally).

Suggested Pad Layout

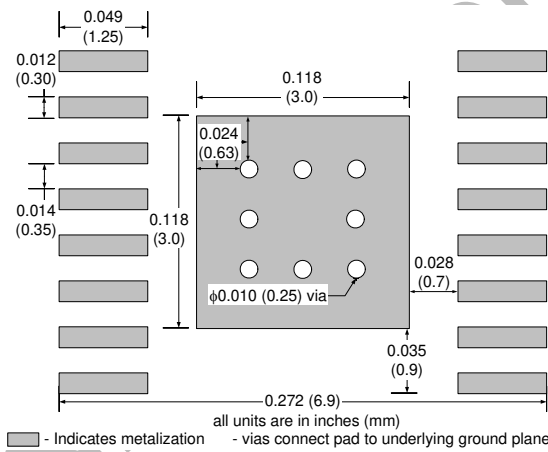

Package Drawing

Dimensions in inches (millimeters)

Refer to drawing posted at www.rfmd.com for tolerances.

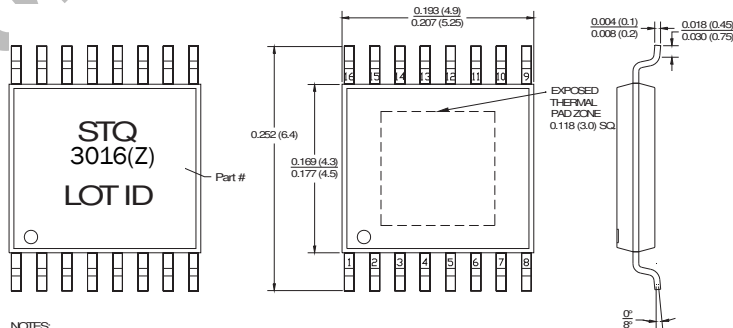

- NOTES:
1. PACKAGE BODY SIZES EXCLUDE MOLD FLASH PROTRUSIONS OR GATE BUFFERS.
 2. TOLERANCE ±0.1MM UNLESS OTHERWISE SPECIFIED.
 3. COPLANARITY: 0.1MM
 4. CONTROLLING DIMENSION IS MILLIMETER. CONVERTED INCH DIMENSIONS ARE NOT NECESSARILY EXACT.
 5. FOLLOWED FROM JEDEC MD-153.

Bill of Materials (for 2500MHz to 3250MHz Evaluation Board P/N EEB-102364)

Component Designator	Description	Value	Qty	Vendor	Mfg Part Number
U1	SiGe Direct Quadrature Modulator		1	SMDI	STQ-2016
P8, P9, P10, P11, P12, P13	SMA connector, end launch with tab, for.062" thick board		6	Johnson Components	142-0701-851
H1, H2	2-pin header, right angle		2	AMP	640453-2
L1	Inductor, 1210 footprint, ±10% tolerance	1uH	1	Panasonic	ELJ-FA1R0KF2
R1, R7, R9, R10	Resistor, 1206 footprint, ±1% tolerance	200 ohm	4	Venkel	CR1206-8W-2000T
R8	Resistor, 0603 footprint, ±1% tolerance	1 kohm	1	Venkel	CR0603-16W-1001FT
C9, C17	Capacitor, 0603 footprint, COG dielectric, ±5% tolerance	1nF	2	Venkel	C0603COG500-102JNE
C3	Capacitor, 1206 footprint, Y5V dielectric, 16V rating	2.2uF	1	Venkel	C1206Y5V160-225ZNE
C4, C5, C18	Capacitor, 0603 footprint, COG dielectric, ±0.25pF tolerance	1.0pF	6	Venkel	C0603COG500-1R0CNE
SH1	Shunt for 2-pin header		1	3M	929950-00
L2, L3, L4, L5	Inductor, 1608 footprint, ±0.3nH tolerance	3.3nH	4	TOKO	LL1608FS-3N3S
C10, C16, C19, C20, C21, C22, C23	Capacitor, 0603 footprint, COG dielectric, ±0.25pF tolerance	1.2pF	6	Venkel	C0603COG500-1R2CNE

Bill of Materials (for 700MHz to 1000MHz Evaluation Board P/N STQ-2016EVB-1)

Component Designator	Description	Value	Qty	Vendor	Mfg Part Number
U1	SiGe Direct Quadrature Modulator		1	SMDI	STQ-2016
P8, P9, P10, P11, P12, P13	SMA connector, end launch with tab, for.062" thick board		6	Johnson Components	142-0701-851
H1, H2	2-pin header, right angle		2	AMP	640453-2
T3, T4	RF transformer, 1200-2200MHz	1:1	2	Panasonic	EHF-FD1619
L1	Inductor, 1210 footprint, ±10% tolerance	1uH	1	Panasonic	ELJ-FA1R0KF2
R1, R7, R9, R10	Resistor, 1206 footprint, ±1% tolerance	200 ohm	4	Venkel	CR1206-8W-2000T
R8	Resistor, 0603 footprint, ±1% tolerance	1 kohm	1	Venkel	CR0603-16W-1001FT
C1, C2	Capacitor, 0603 footprint ±0.25pF tolerance	0.5pF	2	Venkel	C0603COG500-0R5CNE
C6, C18	Capacitor, 0603 footprint, COG dielectric, ±0.25pF tol.	6.8pF	2	Venkel	C0603COG500-6R8CNE
C9, C17	Capacitor, 0603 footprint, COG dielectric, ±5% tolerance	1nF	2	Venkel	C0603COG500-102JNE
C3	Capacitor, 1206 footprint, Y5V dielectric, 16V rating	2.2uF	1	Venkel	C1206Y5V160-225ZNE
C4, C5, C10, C16	Capacitor, 0603 footprint, COG dielectric, ±0.25pF tolerance	2.2pF	4	Venkel	C0603COG500-2R2CNE
SH1	Shunt for 2-pin header		1	3M	929950-00

Direct Quadrature Modulator: General Test Set-Up

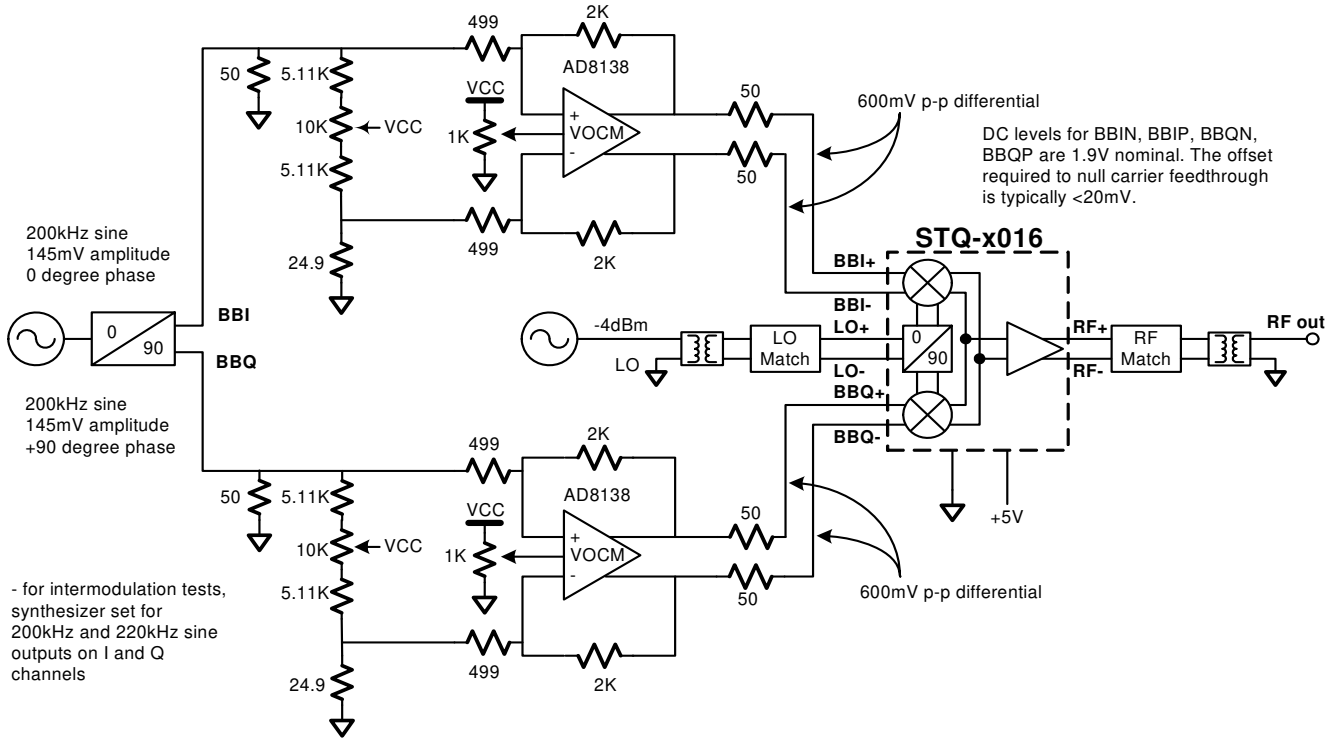

Ordering Information

Part Number	Reel Size	Devices/Reel
STQ-3016	7"	1000
STQ-3016Z	7"	1000

NOT FOR NEW DESIGN

NOT FOR NEW DESIGNSNOT