



Chipsmall Limited consists of a professional team with an average of over 10 year of expertise in the distribution of electronic components. Based in Hongkong, we have already established firm and mutual-benefit business relationships with customers from,Europe,America and south Asia,supplying obsolete and hard-to-find components to meet their specific needs.

With the principle of “Quality Parts,Customers Priority,Honest Operation,and Considerate Service”,our business mainly focus on the distribution of electronic components. Line cards we deal with include Microchip,ALPS,ROHM,Xilinx,Pulse,ON,Everlight and Freescale. Main products comprise IC,Modules,Potentiometer,IC Socket,Relay,Connector.Our parts cover such applications as commercial,industrial, and automotives areas.

We are looking forward to setting up business relationship with you and hope to provide you with the best service and solution. Let us make a better world for our industry!



Contact us

Tel: +86-755-8981 8866 Fax: +86-755-8427 6832

Email & Skype: info@chipsmall.com Web: www.chipsmall.com

Address: A1208, Overseas Decoration Building, #122 Zhenhua RD., Futian, Shenzhen, China



A. Electrical specifications (@ 25 ° C)

1. Leakage Inductance;
30 μ H MAX
2. DC Resistance;
Primary (1-2) 2.5 Ω MAX
Secondary (3-4) 1.5 Ω MAX
Tertiary (5-6) 1.5 Ω MAX
3. Primary ET-constant;
90V- μ s MIN
4. Turns Ratio;
(1-2) : (3-4) : (5-6) = 2 : 1.00 : 1.00 \pm 5%
5. Interwinding Capacitance;
80.0 pF MAX
6. Primary Inductance;
1.0 mH MIN
7. Dielectric Strength;
AC 2600 Vrms 1 minute @ Pri to Sec

B. Marking;

STT-110, TAMURA, date code, and country of origin

C. Schematic diagram;

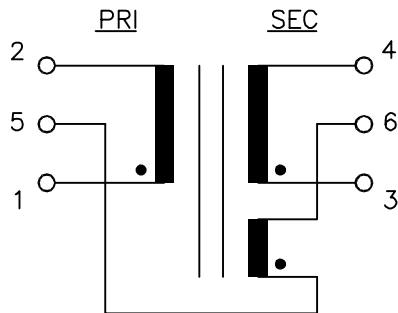

Country of origin

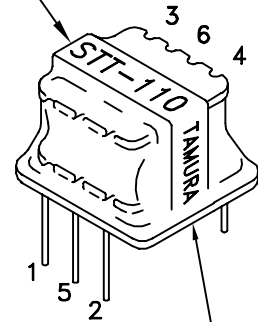

Date code

D. Mechanical Specifications

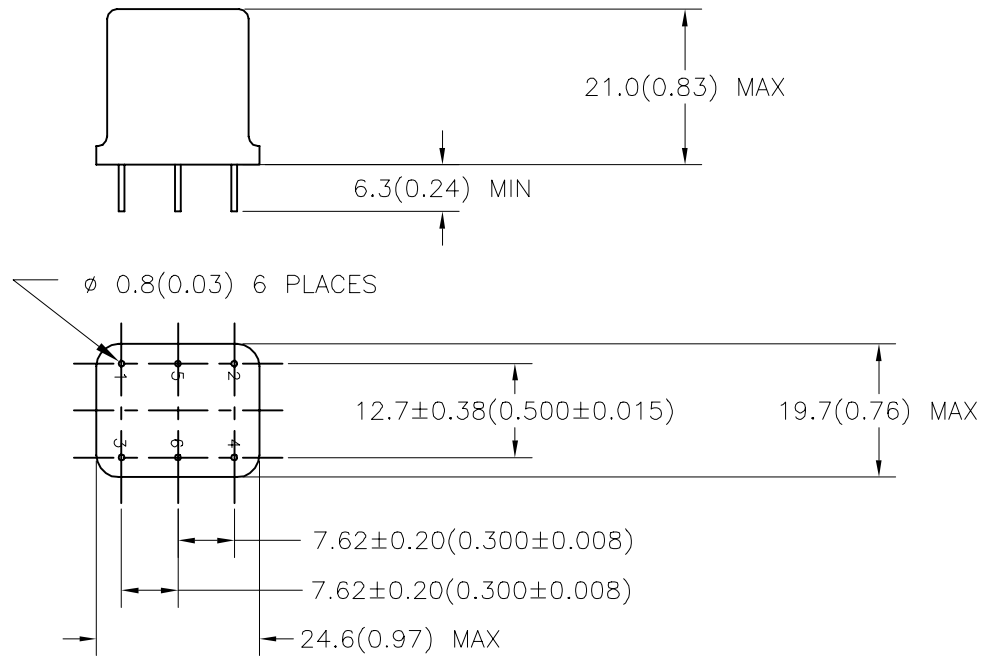

PREPARED BY: K. Brennan	DWG CONTROL NO. P-A1-11370 ACAD\MXFMR\A1113701.DWG	REV -	ENCAPSULATED TRIGGER TRANSFORMER	STT-110 MODEL SPECIFICATION
ENGINEER: T. Shiozawa	CONTENTS OF THIS DRAWING ARE SUBJECT TO CHANGE WITHOUT PRIOR NOTICE		TAMURA CORPORATION OF AMERICA 43352 BUSINESS PARK DRIVE, TEMECULA, CA. 92590-6624 (909) 699-1270 FAX 9096769482	
APPROVED: V. Casey	PROPRIETARY NOTICE: THIS DRAWING PRINT OR DOCUMENT AND SUBJECT MATTER DISCLOSED HEREIN ARE PROPRIETARY ITEMS TO WHICH TAMURA RETAINS THE EXCLUSIVE RIGHT OF DISSEMINATION, REPRODUCTION, MANUFACTURE AND SALE. THIS DRAWING, PRINT OR DOCUMENT IS SUBMITTED IN CONFIDENCE FOR CONSIDERATION BY THE RECIPIENT ALONE UNLESS PERMISSION FOR FURTHER DISCLOSURE IS EXPRESSLY GRANTED IN WRITING.			DIM: mm(In) SCL: NONE SH: 1 OF 1