



Chipsmall Limited consists of a professional team with an average of over 10 year of expertise in the distribution of electronic components. Based in Hongkong, we have already established firm and mutual-benefit business relationships with customers from,Europe,America and south Asia,supplying obsolete and hard-to-find components to meet their specific needs.

With the principle of “Quality Parts,Customers Priority,Honest Operation,and Considerate Service”,our business mainly focus on the distribution of electronic components. Line cards we deal with include Microchip,ALPS,ROHM,Xilinx,Pulse,ON,Everlight and Freescale. Main products comprise IC,Modules,Potentiometer,IC Socket,Relay,Connector.Our parts cover such applications as commercial,industrial, and automotives areas.

We are looking forward to setting up business relationship with you and hope to provide you with the best service and solution. Let us make a better world for our industry!



Contact us

Tel: +86-755-8981 8866 Fax: +86-755-8427 6832

Email & Skype: info@chipsmall.com Web: www.chipsmall.com

Address: A1208, Overseas Decoration Building, #122 Zhenhua RD., Futian, Shenzhen, China



Ultrafast recovery diode

Datasheet - production data

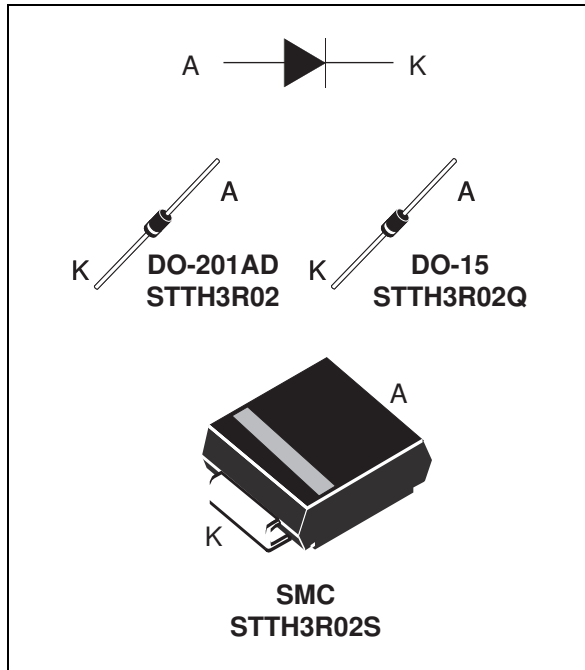

Table 1. Device summary

$I_{F(AV)}$	3 A
V_{RRM}	200 V
$T_j(\text{max})$	175 °C
$V_F(\text{typ})$	0.7 V
$t_{rr}(\text{typ})$	16 ns

Features

- Very low conduction losses
- Negligible switching losses
- Low forward and reverse recovery times
- High junction temperature

Description

The STTH3R02 uses ST's new 200 V planar Pt doping technology, and it is specially suited for switching mode base drive and transistor circuits.

Packaged in DO-201AD, DO-15, and SMC, this device is intended for use in low voltage, high frequency inverters, free wheeling and polarity protection.

1 Characteristics

Table 2. Absolute ratings (limiting values at $T_j = 25\text{ °C}$, unless otherwise specified)

Symbol	Parameter		Value	Unit
V_{RRM}	Repetitive peak reverse voltage		200	V
I_{FRM}	Repetitive peak forward current	$t_p = 5\ \mu\text{s}$, $F = 5\ \text{kHz}$	110	A
$I_{F(RMS)}$	Forward rms current	DO-201AD / DO-15	70	A
		SMC	70	
$I_{F(AV)}$	Average forward current, $\delta = 0.5$	DO-15 $T_{lead} = 50\text{ °C}$	3	A
		DO-201AD $T_{lead} = 90\text{ °C}$		
		SMC $T_c = 110\text{ °C}$		
I_{FSM}	Surge non repetitive forward current	$t_p = 10\ \text{ms}$ Sinusoidal	75	A
T_{stg}	Storage temperature range		-65 to + 175	°C
T_j	Maximum operating junction temperature		175	°C
T_L	Maximum lead temperature for soldering during 10 s at 4 mm from case		230	°C

Table 3. Thermal parameters

Symbol	Parameter		Value	Unit	
$R_{th(j-l)}$	Junction to lead	Lead Length = 10 mm on infinite heatsink	DO-15	45	°C/W
			DO-201AD	30	
$R_{th(j-c)}$	Junction to case		SMC	20	

Table 4. Static electrical characteristics

Symbol	Parameter	Test conditions		Min.	Typ.	Max.	Unit
$I_R^{(1)}$	Reverse leakage current	$T_j = 25\text{ °C}$	$V_R = V_{RRM}$			3	μA
		$T_j = 125\text{ °C}$			3	30	
$V_F^{(2)}$	Forward voltage drop	$T_j = 25\text{ °C}$	$I_F = 9\ \text{A}$			1.20	V
		$T_j = 25\text{ °C}$			0.89	1.0	
		$T_j = 100\text{ °C}$	$I_F = 3\ \text{A}$		0.76	0.85	
		$T_j = 150\text{ °C}$			0.70	0.80	

1. Pulse test: $t_p = 5\ \text{ms}$, $\delta < 2\ \%$

2. Pulse test: $t_p = 380\ \mu\text{s}$, $\delta < 2\ \%$

To evaluate the conduction losses use the following equation:

$$P = 0.68 \times I_{F(AV)} + 0.04 I_{F(RMS)}^2$$

Table 5. Dynamic characteristics

Symbol	Parameter	Test conditions	Min.	Typ.	Max.	Unit
t_{rr}	Reverse recovery time	$I_F = 1\text{ A}$, $di_F/dt = -50\text{ A}/\mu\text{s}$, $V_R = 30\text{ V}$, $T_j = 25\text{ }^\circ\text{C}$		24	30	ns
		$I_F = 1\text{ A}$, $di_F/dt = -100\text{ A}/\mu\text{s}$, $V_R = 30\text{ V}$, $T_j = 25\text{ }^\circ\text{C}$		16	20	
I_{RM}	Reverse recovery current	$I_F = 3\text{ A}$, $di_F/dt = -200\text{ A}/\mu\text{s}$, $V_R = 160\text{ V}$, $T_j = 125\text{ }^\circ\text{C}$		3.5	4.5	A
t_{fr}	Forward recovery time	$I_F = 3\text{ A}$, $di_F/dt = 100\text{ A}/\mu\text{s}$ $V_{FR} = 1.1 \times V_{Fmax}$, $T_j = 25\text{ }^\circ\text{C}$		40		ns
V_{FP}	Forward recovery voltage	$I_F = 3\text{ A}$, $di_F/dt = 100\text{ A}/\mu\text{s}$, $T_j = 25\text{ }^\circ\text{C}$		1.9		V

Figure 1. peak current versus duty cycle

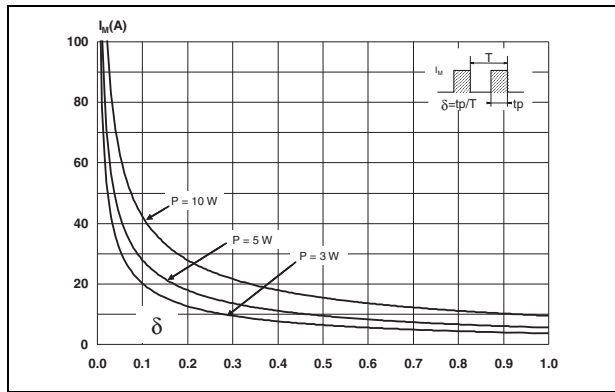

Figure 2. Forward voltage drop versus forward current (typical values)

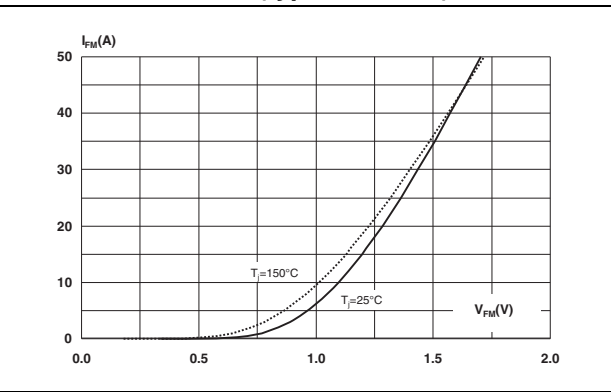

Figure 3. Forward voltage drop versus forward current (maximum values)

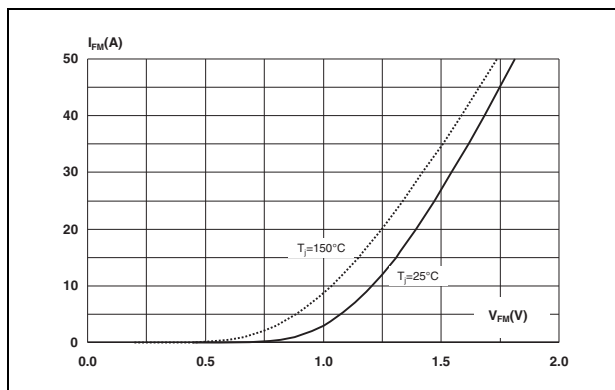

Figure 4. Relative variation of thermal impedance junction to ambient versus pulse duration - DO-201AD

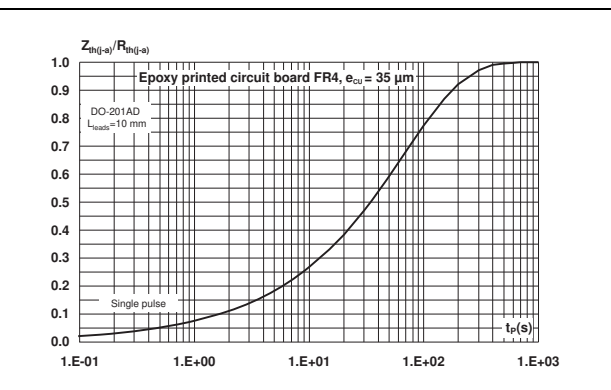

Figure 5. Relative variation of thermal impedance junction to ambient versus pulse duration - DO-15

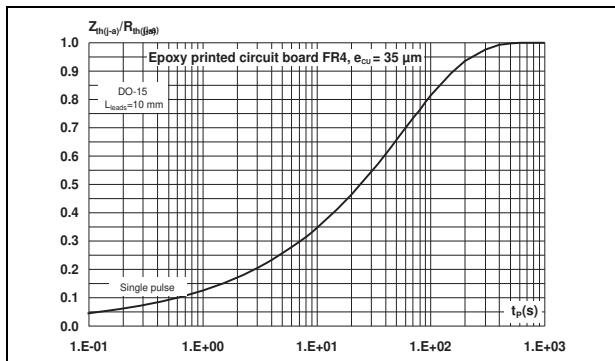

Figure 6. Relative variation of thermal impedance junction to ambient versus pulse duration - SMC

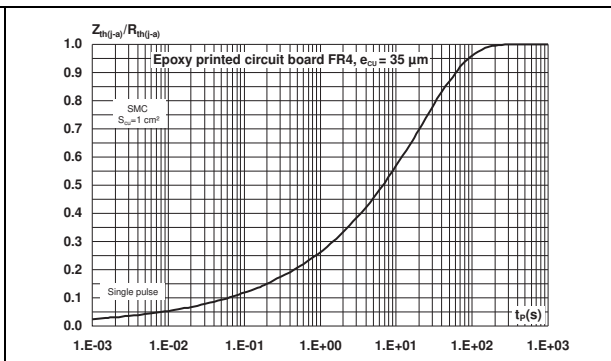

Figure 7. Junction capacitance versus reverse applied voltage (typical values)

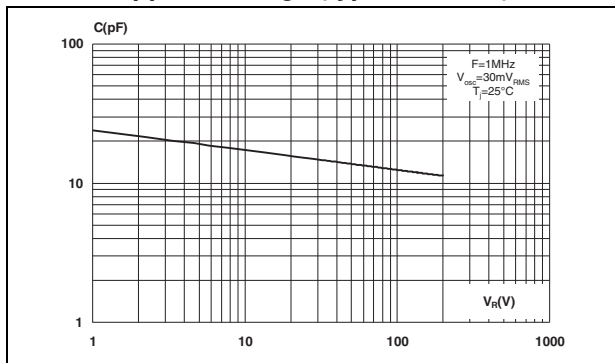

Figure 8. Reverse recovery charges versus dI_F/dt (typical values)

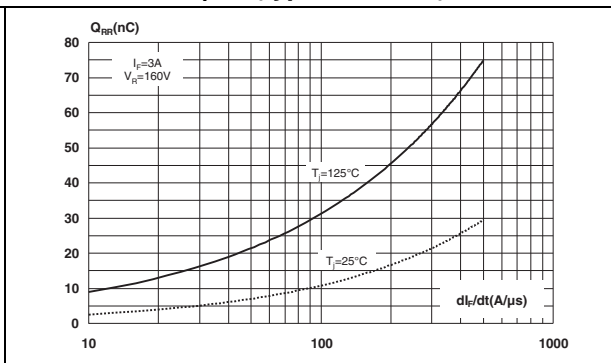

Figure 9. Reverse recovery time versus dI_F/dt (typical values)

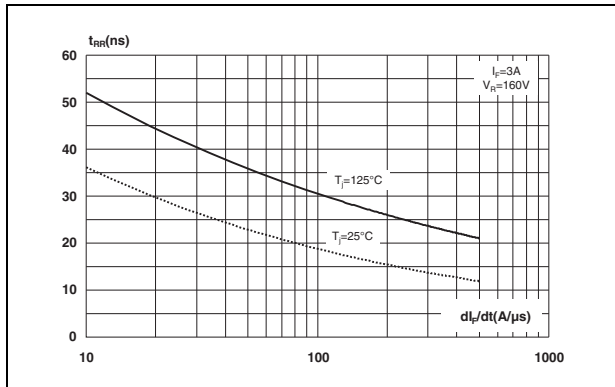

Figure 10. Peak reverse recovery current versus dI_F/dt (typical values)

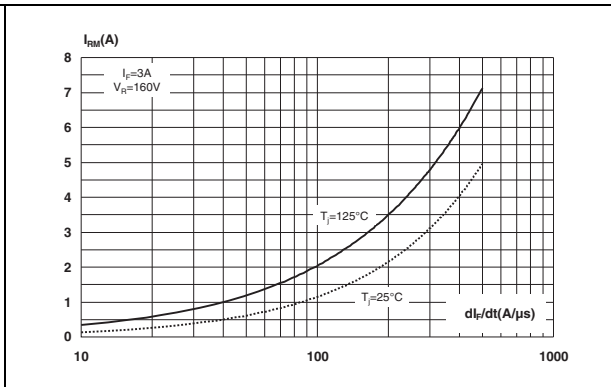

Figure 11. Dynamic parameters versus junction temperature

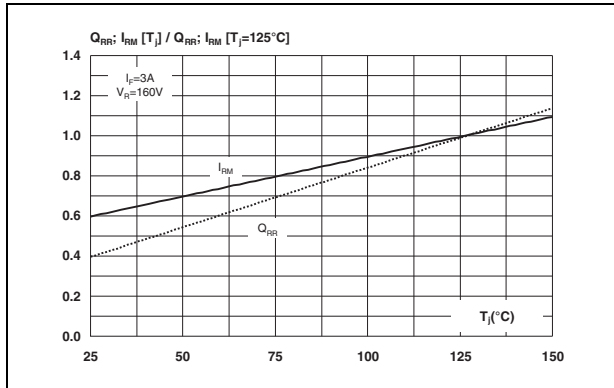

Figure 12. Thermal resistance junction to ambient versus copper surface under each lead

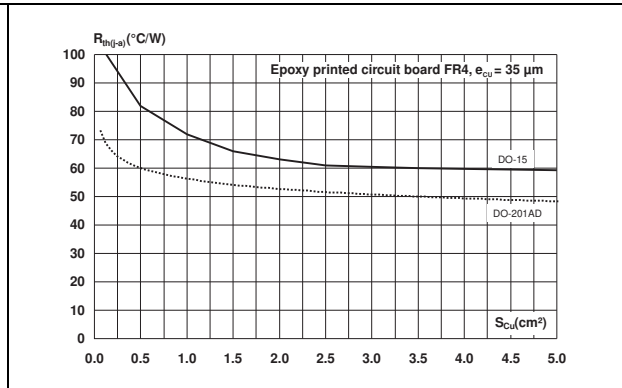

Figure 13. Thermal resistance versus copper surface under each lead for SMC

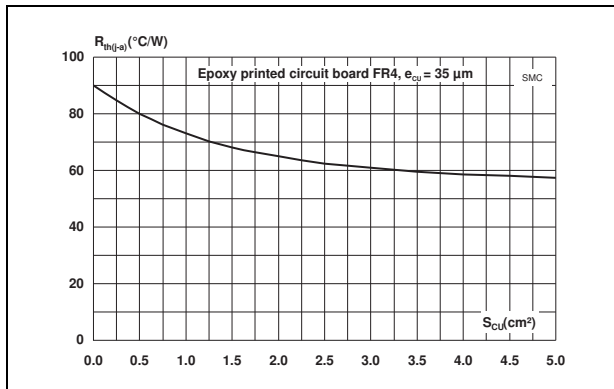
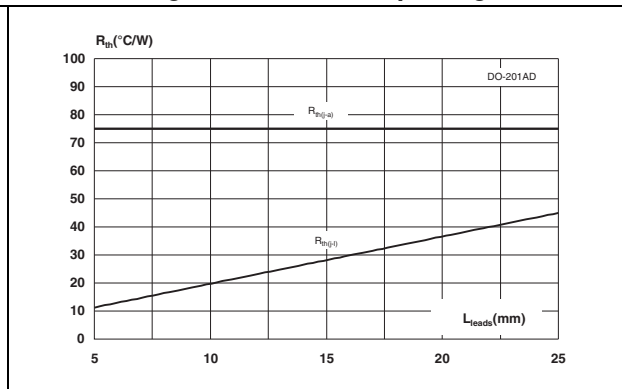
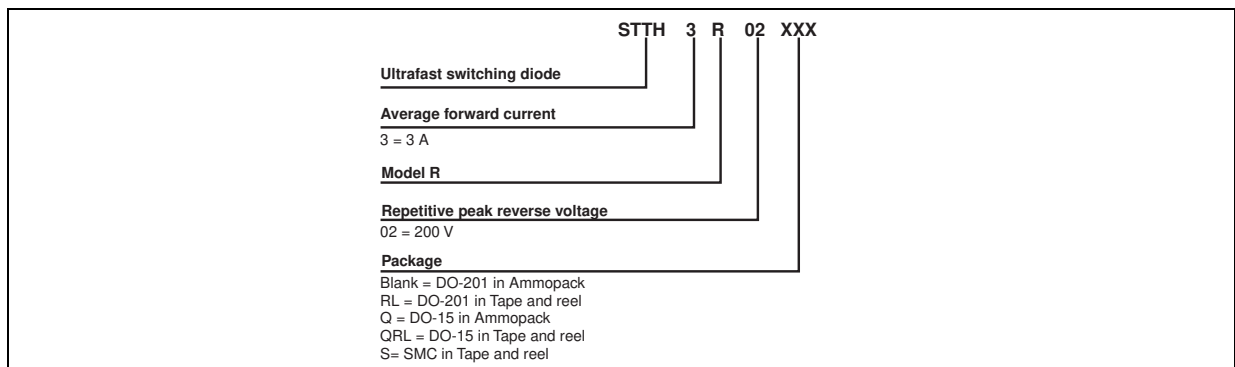

Figure 14. Thermal resistance versus lead length for DO-201AD package



2 Ordering information scheme

Figure 15. Ordering information scheme



3 Package information

- Epoxy meets UL94, V0
- Cooling method: by conduction (C)

In order to meet environmental requirements, ST offers these devices in different grades of ECOPACK® packages, depending on their level of environmental compliance. ECOPACK® specifications, grade definitions and product status are available at: www.st.com. ECOPACK® is an ST trademark.

Table 6. DO-201AD dimensions

Ref.	Dimensions			
	Millimeters		Inches	
	Min.	Max.	Min.	Max.
A		9.50		0.374
B	25.40		1.000	
C		5.30		0.209
D		1.30		0.051
E		1.25		0.049
Notes	1 - The lead diameter $\varnothing D$ is not controlled over zone E 2 - The minimum length which must stay straight between the right angles after bending is 0.59"(15mm)			

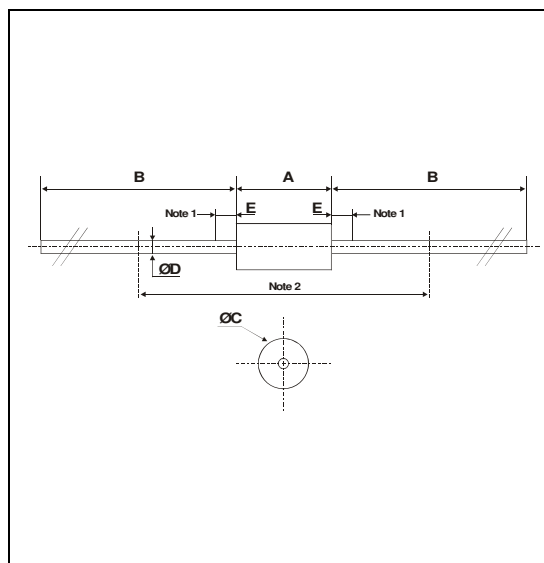

Table 7. DO-15 dimensions

Ref.	Dimensions			
	Millimeters		Inches	
	Min.	Max.	Min.	Max.
A	6.05	6.75	0.238	0.266
B	2.95	3.53	0.116	0.139
C	26	31	1.024	1.220
D	0.71	0.88	0.028	0.035

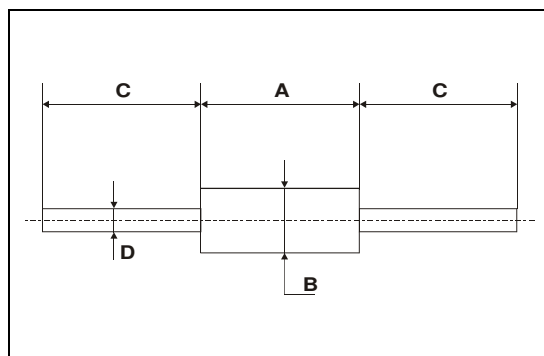

Table 8. SMC dimensions

Ref.	Dimensions			
	Millimeters		Inches	
	Min.	Max.	Min.	Max.
A1	1.90	2.45	0.075	0.096
A2	0.05	0.20	0.002	0.008
b	2.90	3.2	0.114	0.126
c	0.15	0.41	0.006	0.016
E	7.75	8.15	0.305	0.321
E1	6.60	7.15	0.260	0.281
E2	4.40	4.70	0.173	0.185
D	5.55	6.25	0.218	0.246
L	0.75	1.60	0.030	0.063

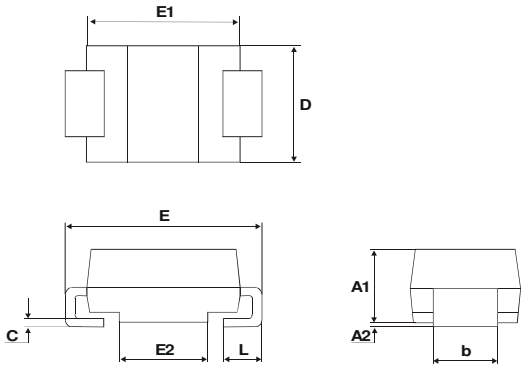
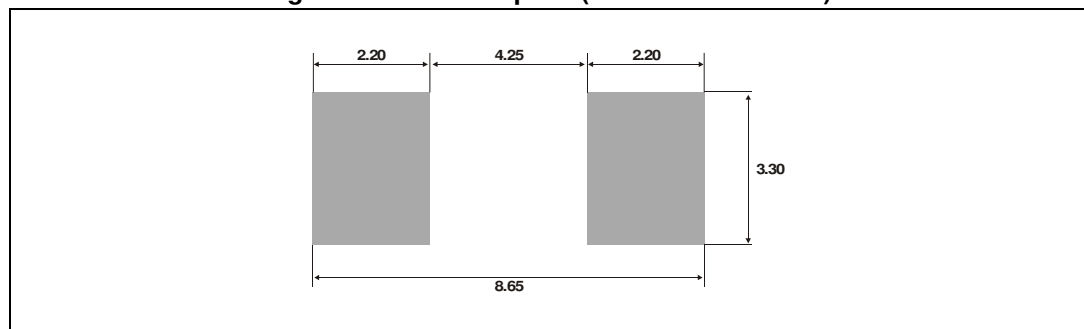

Figure 16. SMC footprint (dimensions in mm)



4 Ordering information

Table 9. Ordering information

Order code	Marking	Package	Weight	Base qty	Delivery mode
STTH3R02	STTH3R02	DO-201AD	1.16 g	600	Ammopack
STTH3R02RL	STTH3R02	DO-201AD	1.16 g	1900	Tape and reel
STTH3R02Q	STTH3R02	DO-15	0.4 g	1000	Ammopack
STTH3R02QRL	STTH3R02	DO-15	0.4 g	6000	Tape and reel
STTH3R02S	3R2S	SMC	0.243 g	2500	Tape and reel

5 Revision history

Table 10. Document revision history

Date	Revision	Changes
03-May-2006	1	First issue.
10-Oct-2006	2	Added SMC package.
17-Apr-2014	3	Updated ECOPACK statement. Reformatted to current standards.

Please Read Carefully:

Information in this document is provided solely in connection with ST products. STMicroelectronics NV and its subsidiaries ("ST") reserve the right to make changes, corrections, modifications or improvements, to this document, and the products and services described herein at any time, without notice.

All ST products are sold pursuant to ST's terms and conditions of sale.

Purchasers are solely responsible for the choice, selection and use of the ST products and services described herein, and ST assumes no liability whatsoever relating to the choice, selection or use of the ST products and services described herein.

No license, express or implied, by estoppel or otherwise, to any intellectual property rights is granted under this document. If any part of this document refers to any third party products or services it shall not be deemed a license grant by ST for the use of such third party products or services, or any intellectual property contained therein or considered as a warranty covering the use in any manner whatsoever of such third party products or services or any intellectual property contained therein.

UNLESS OTHERWISE SET FORTH IN ST'S TERMS AND CONDITIONS OF SALE ST DISCLAIMS ANY EXPRESS OR IMPLIED WARRANTY WITH RESPECT TO THE USE AND/OR SALE OF ST PRODUCTS INCLUDING WITHOUT LIMITATION IMPLIED WARRANTIES OF MERCHANTABILITY, FITNESS FOR A PARTICULAR PURPOSE (AND THEIR EQUIVALENTS UNDER THE LAWS OF ANY JURISDICTION), OR INFRINGEMENT OF ANY PATENT, COPYRIGHT OR OTHER INTELLECTUAL PROPERTY RIGHT.

ST PRODUCTS ARE NOT DESIGNED OR AUTHORIZED FOR USE IN: (A) SAFETY CRITICAL APPLICATIONS SUCH AS LIFE SUPPORTING, ACTIVE IMPLANTED DEVICES OR SYSTEMS WITH PRODUCT FUNCTIONAL SAFETY REQUIREMENTS; (B) AERONAUTIC APPLICATIONS; (C) AUTOMOTIVE APPLICATIONS OR ENVIRONMENTS, AND/OR (D) AEROSPACE APPLICATIONS OR ENVIRONMENTS. WHERE ST PRODUCTS ARE NOT DESIGNED FOR SUCH USE, THE PURCHASER SHALL USE PRODUCTS AT PURCHASER'S SOLE RISK, EVEN IF ST HAS BEEN INFORMED IN WRITING OF SUCH USAGE, UNLESS A PRODUCT IS EXPRESSLY DESIGNATED BY ST AS BEING INTENDED FOR "AUTOMOTIVE, AUTOMOTIVE SAFETY OR MEDICAL" INDUSTRY DOMAINS ACCORDING TO ST PRODUCT DESIGN SPECIFICATIONS. PRODUCTS FORMALLY ESCC, QML OR JAN QUALIFIED ARE DEEMED SUITABLE FOR USE IN AEROSPACE BY THE CORRESPONDING GOVERNMENTAL AGENCY.

Resale of ST products with provisions different from the statements and/or technical features set forth in this document shall immediately void any warranty granted by ST for the ST product or service described herein and shall not create or extend in any manner whatsoever, any liability of ST.

ST and the ST logo are trademarks or registered trademarks of ST in various countries.

Information in this document supersedes and replaces all information previously supplied.

The ST logo is a registered trademark of STMicroelectronics. All other names are the property of their respective owners.

© 2014 STMicroelectronics - All rights reserved

STMicroelectronics group of companies

Australia - Belgium - Brazil - Canada - China - Czech Republic - Finland - France - Germany - Hong Kong - India - Israel - Italy - Japan - Malaysia - Malta - Morocco - Philippines - Singapore - Spain - Sweden - Switzerland - United Kingdom - United States of America

www.st.com

