



Chipsmall Limited consists of a professional team with an average of over 10 year of expertise in the distribution of electronic components. Based in Hongkong, we have already established firm and mutual-benefit business relationships with customers from,Europe,America and south Asia,supplying obsolete and hard-to-find components to meet their specific needs.

With the principle of "Quality Parts,Customers Priority,Honest Operation,and Considerate Service",our business mainly focus on the distribution of electronic components. Line cards we deal with include Microchip,ALPS,ROHM,Xilinx,Pulse,ON,Everlight and Freescale. Main products comprise IC,Modules,Potentiometer,IC Socket,Relay,Connector.Our parts cover such applications as commercial,industrial, and automotives areas.

We are looking forward to setting up business relationship with you and hope to provide you with the best service and solution. Let us make a better world for our industry!



Contact us

Tel: +86-755-8981 8866 Fax: +86-755-8427 6832

Email & Skype: info@chipsmall.com Web: www.chipsmall.com

Address: A1208, Overseas Decoration Building, #122 Zhenhua RD., Futian, Shenzhen, China





SY58051U

Ultra-Precision CML AnyGate[®]
with Internal Input and Output Termination

Precision Edge[®]

General Description

The SY58051U is an ultra-fast, low jitter universal logic gate with a guaranteed maximum data or clock throughput of 10.7Gbps or 7GHz, respectively. This AnyGate[®] differential logic device will produce many logic functions of two Boolean variables, such as AND, NAND, OR, NOR, DELAY, or NEGATION.

The SY58051U differential inputs include a unique internal termination design that allows access to the termination network throughout a V_T pin. This feature allows the device to easily interface to different logic standards, both AC- and DC-coupled without external resistor-bias and termination networks. The result is a clean, stub-free, low-jitter interface solution. The differential CML output is optimized for environments with internal 50 Ω source termination and a 400mV output swing.

The SY58051U operates from a 2.5 or 3.3V supply, and is guaranteed over the full industrial temperature range (-40°C to +85°C). The SY58051U is part of Micrel's Precision Edge[®] product family.

All support documentation can be found on Micrel's web site at www.micrel.com.

Typical Application

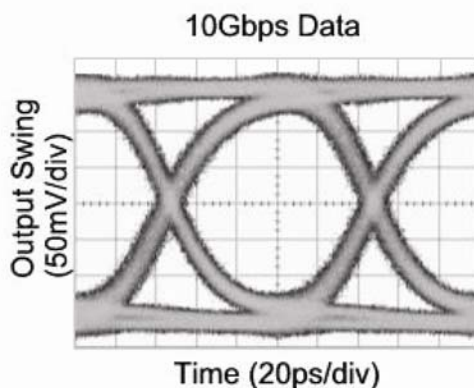

AnyGate and Precision Edge are registered trademarks of Micrel, Inc.
MLF and MicroLeadFrame are registered trademarks of Amkor Technology, Inc.

Micrel Inc. • 2180 Fortune Drive • San Jose, CA 95131 • USA • tel +1 (408) 944-0800 • fax + 1 (408) 474-1000 • <http://www.micrel.com>

July 2011

M9999-071311U-A
hbwhelp@micrel.com or (408) 955-1690



Precision Edge[®]

Features

- Three matched-delay input pair provide any logic function: AND, NAND, OR, NOR
- Guaranteed AC performance over temperature and voltage:
 - DC to > 10.7Gbps data rate throughput
 - DC to > 7GHz clock f_{MAX}
 - <190ps Any In-to-Out t_{pd}
 - $t_r / t_f < 60ps$
- Ultra low-jitter design:
 - <1ps_{RMS} random jitter
 - <10ps_{PP} deterministic jitter
 - <10ps_{PP} total jitter (clock)
- Unique input termination and V_T pin accepts DC-coupled and AC-coupled inputs (CML, PECL)
- Internal 50 Ω output source termination
- Typical 400mV CML output swing ($R_{IN} = 50\Omega$)
- Internal 50 Ω input termination
- Power supply 2.5V $\pm 5\%$ or 3.3V $\pm 10\%$
- -40°C to 85°C temperature range
- Available in a 16-pin (3mm \times 3mm) QFN[®] package

Applications

- Data communication systems
- OC-192, OC192+FEC
- All SONET OC-3—OC-768 applications
- All Fibre Channel applications
- All GigE applications

Ordering Information

Part Number	Package Type	Operational Range	Package Marking
SY58051UMG ⁽³⁾	Pb-free QFN-16	Industrial	051U with Pb-Free bar-line indicator
SY58051UMGTR ^(2, 3)	Pb-free QFN-16	Industrial	051U with Pb-Free bar-line indicator

Pin Configuration

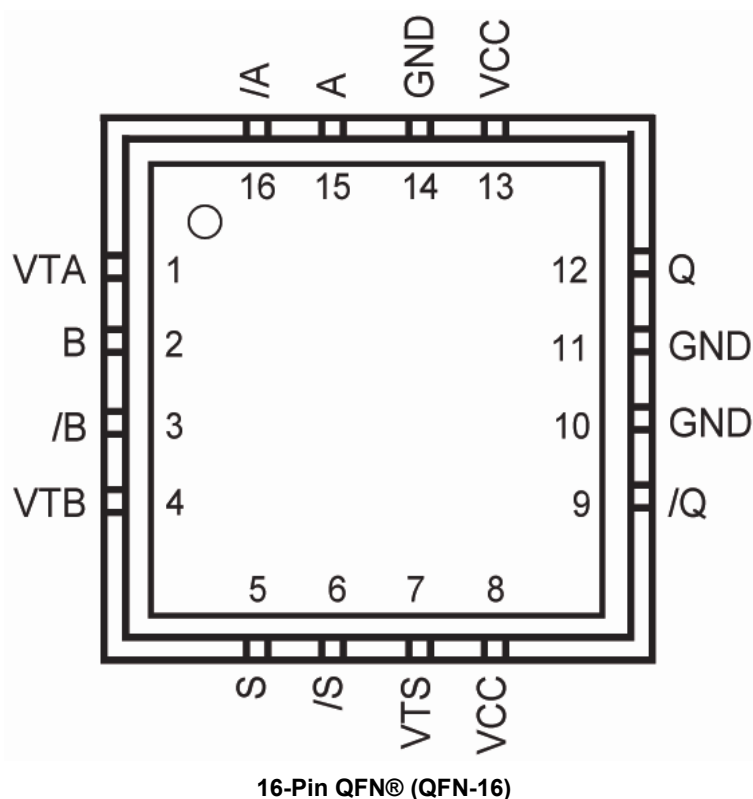

Pin Description

Pin Number	Pin Name	Pin Function
1	VT	Input Termination Center Tap: Each of the two inputs, (A, /A) terminates to this pin through a 50Ω resistor. The VTA pin provides a center-tap to a termination network for maximum interface flexibility. See "Input Interface Applications" section for more details.
15, 16 2, 3	A, /A B, /B	Differential Input: These input pairs are the two data inputs to the device. Each pin of a pair 2, 3 B, /B internally terminates to the VTA or VTB pin to 50Ω. Note that these inputs will default to an indeterminate state if left open. See "Input Interface Applications" section for more details.
4	VTB	Input Termination Center Tap: Each of the two inputs, (B, /B) terminates to this pin through a 50Ω resistor. The VTB pin provides a center-tap to a termination network for maximum interface flexibility.
5, 6	S, /S	Differential Input: This input pair is the select input to the device. Each pin of this pair internally terminates to the VTS pin to 50Ω. Note that this input will default to an indeterminate state if left open. See "Input Interface Applications" section for more details.
7	VTS	Input Termination Center Tap: Each of the two inputs, S, /S terminates to this pin. The VTS pin provides a center-tap to a termination network for maximum interface flexibility.
8, 13	VCC	Positive Power Supply. Bypass with 0.1μF □ □ 0.01μF low ESR capacitors.
12, 9	Q, /Q	Differential Output: This CML output pair is the output of the device. It is a logic function of the A, B, and S inputs. See "Truth Tables" for details.
10, 11, 14	GND	Ground. Exposed pad must be connected to the same potential as GND pin.

Truth Tables

A	/A	B	/B	S	/S	Q	/Q
0	1	X	X	0	1	0	1
1	0	X	X	0	1	1	0
X	X	0	1	1	0	0	1
X	X	1	0	1	0	1	0

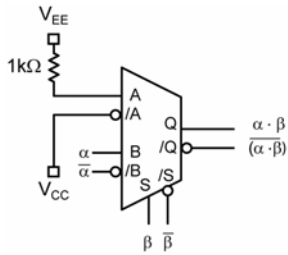

AND/NAND

	α	β	$\alpha \cdot \beta$	$\overline{(\alpha \cdot \beta)}$
A	B	B	Q	/Q
L	L	L	L	H
L	H	L	L	H
L	L	H	L	H
L	H	H	H	L

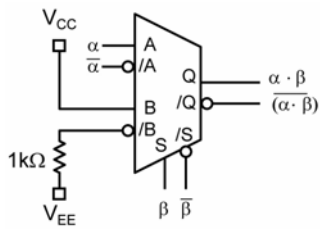

OR/NOR

	α	β	$\alpha \cdot \beta$	$\overline{(\alpha \cdot \beta)}$
A	B	B	Q	/Q
L	H	L	L	H
H	H	L	H	L
L	H	H	H	L
H	H	H	H	L

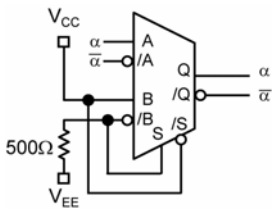

DELAY/NEGATION

α			α	$\bar{\alpha}$
A	B	S	Q	/Q
L		S	L	H
H		S	H	L

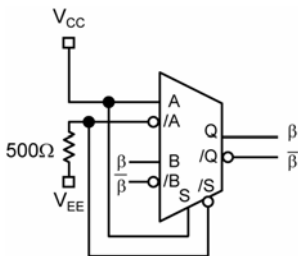

DELAY/NEGATION

	β		β	$\bar{\beta}$
A	B	S	Q	/Q
	L	H	L	H
	H	H	H	L

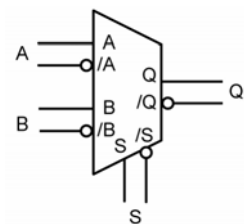

2:1 MUX

	S	Q	/Q
	L	A	\bar{A}
	H	B	\bar{B}

Absolute Maximum Ratings ⁽¹⁾

Supply Voltage (V_{CC})	-0.5 to +4.0V
Input Voltage (V_{IN})	-0.5V to V_{CC}
CML Output Voltage (V_{OUT})	V_{CC} to -1.0V to $V_{CC} + 0.5V$
Termination Current ⁽³⁾	
Source or Sink Current on V_{TA} , V_{TB} , V_{TS}	±60mA
Input Current	
Source or Sink Current on A, /A, B, /B, S, /S	±30mA
Lead Temperature (soldering, 20 sec.)	+260°C
Storage Temperature (T_S)	-65°C to +150°C

Operating Ratings ⁽²⁾

Supply Voltage (V_{CC})	+2.375V to +2.625V or +3.0°C to +85°C
Ambient Temperature (T_A)	-40°C to +85°C
Package Thermal Resistance ⁽⁴⁾	
PDIP (θ_{JA})	
Still-Air	61°C/W
QFN (ψ_{JB})	38°C/W

DC Electrical Characteristics ⁽⁵⁾

$T_A = -40^\circ\text{C}$ to $+85^\circ\text{C}$, unless otherwise noted.

Symbol	Parameter	Condition	Min.	Typ.	Max.	Units
V_{CC}	Power Supply	$V_{CC} = 2.5V$.	2.375	2.5	2.625	V
		$V_{CC} = 3.3V$.	3.0	3.3	3.6	V
I_{CC}	Power Supply Current	No Load, max. V_{CC} .		55	70	mA
R_{DIFF_IN}	Differential Input Resistance (A-to/A, B-to-/B or S-to/S)		80	100	120	Ω
R_{IN}	Input Resistance (A-to- V_{TA} , B-to- V_{TB} or S-to- V_{TS})		40	50	60	Ω
V_{IH}	Input HIGH Voltage (A, /A or B, /B or S, /S)	Note 6	1.2		V_{CC}	V
V_{IL}	Input LOW Voltage (A, /A or B, /B or S, /S)	Note 6	0		$V_{IH}-0.1$	mV
V_{IN}	Input Voltage Swing (A, /A or B, /B or S, /S)	Note 6 See Figure 2a.	100			mV
V_{DIFF_IN}	Differential Input Voltage Swing IA-, /AI or IB-, /BI or S-, /SI	Note 6 See Figure 2b.	200			mV
I_{IN}^I	Input Current (A, /A or B, /B or S, /S)	Note 6			21	mA

Notes:

- Permanent device damage may occur if the ratings in the "Absolute Maximum Ratings" section are exceeded. This is a stress rating only and functional operation is not implied for conditions other than those detailed in the operational sections of this data sheet. Exposure to absolute maximum ratings conditions for extended periods may affect device reliability.
- The data sheet limits are not guaranteed if the device is operated beyond the operating ratings.
- Due to the limited drive capability use for input of the same package only.
- Package thermal resistance assumes exposed pad is soldered (or equivalent) to the devices most negative potential on the PCB. ψ_{JB} uses 4-layer θ_{JA} n still-air, unless otherwise stated.
- The circuit is designed to meet the DC specifications shown in the above table after thermal equilibrium has been established.
- Due to the internal termination (see Figure 1a) the input current depends on the applied voltages at A, /A and V_{TA} inputs, the B, /B and V_{TB} inputs or the S, /S and V_{TS} inputs. Do not apply a combination of voltages that causes the input current to exceed the maximum limit.

CML Electrical Characteristics ⁽⁵⁾

$V_{CC} = 2.5V \pm 5\%$ or $3.3V \pm 10\%$; $R_L = 100\Omega$ across output pair or equivalent; $T_A = -40^\circ C$ to $+85^\circ C$; unless otherwise noted.

Symbol	Parameter	Condition	Min.	Typ	Max	Units
V_{CH}	Output HIGH Voltage Q, /Q		$V_{CC} - 0.020$		$V_{CC} 3.6$	V
V_{OUT}	Output Voltage Swing Q, /Q	See Figure 2a.	325	400	500	mV
V_{DIFF_OUT}	Differential Output Voltage Swing Q, /Q	See Figure 2b.	650	800	1000	mV
R_{OUT}	Output Source Impedance Q, /Q		40	50	60	Ω

AC Electrical Characteristics ⁽⁸⁾

$V_{CC} = 2.5V \pm 5\%$ or $3.3V \pm 10\%$; $R_L = 100\Omega$ across output pair or equivalent; $T_A = -40^\circ C$ to $+85^\circ C$; unless otherwise noted.

Symbol	Parameter	Condition	Min	Typ	Max	Units
F_{MAX}	Maximum Operating Frequency	Clock NRZ Data	10.7	7		GHz Gbps
t_{pd}	Propagation Delay Any Input (A, B, S)-to-Q		70		190	ps
t_{SKEW}	Part-to-Part Skew	Note 9			100	ps
t_{JITTER}	Data					
	Random Jitter (RJ)	Note 10			1	μS_{RMS}
	Deterministic Jitter (DJ)	Note 11			10	μS_{PP}
	Clock					
	Cycle-to-Cycle Jitter (RJ)	Note 12			1	μS_{RMS}
	Total Jitter (TJ)	Note 13			10	μS_{PP}
T_R, t_f	Output Rise/Fall Times (20% to 80%)	At full output swing.	20		60	ps

Notes:

- The circuit is designed to meet the DC specifications shown in the above table after thermal equilibrium has been established.
- Measured with 100mV input swing. See "Timing Diagrams" section for definition of parameters. High-frequency AC parameters are guaranteed by design and characterization.
- Skew is defined for two parts with identical power supply voltages at the same temperature and with no skew of the edges at the respective inputs.
- Random jitter is measured with a K28.7 comma detect character pattern, measured at 2.5Gbps/3.2Gbps.
- Deterministic jitter is measured at 2.5Gbps/3.2Gbps with both K28.5 and $2^{23}-1$ PRBS pattern.
- Cycle-to-cycle jitter definition: the variation of periods between adjacent cycles, $T_n - T_{n-1}$ where T is the time between rising edges of the output signal.
- Total jitter definition: with an ideal clock input of frequency $\leq f_{MAX}$, no more than one output edge in 10^{12} output edges will deviate by more than the specified peak-to-peak jitter value.

Functional Block Diagram

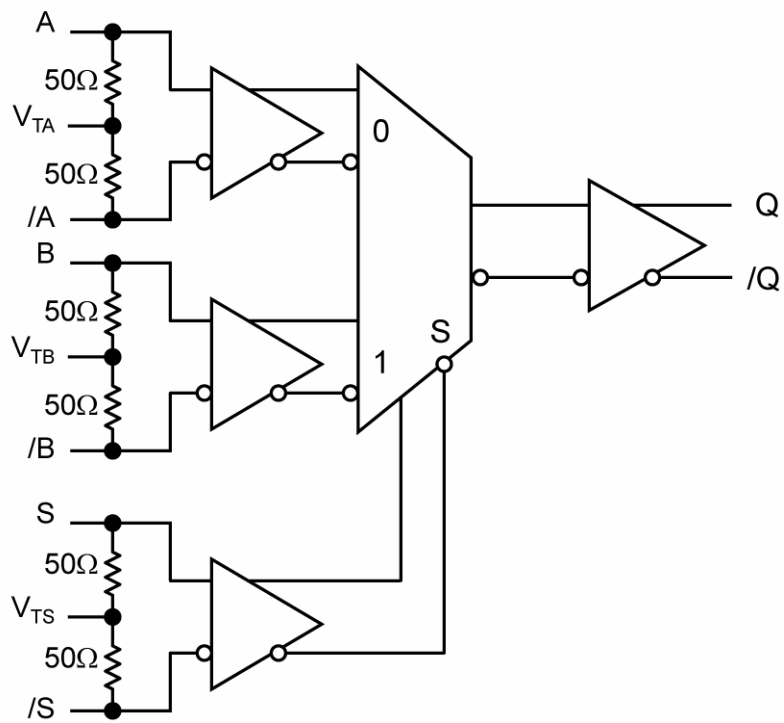

Timing Diagram

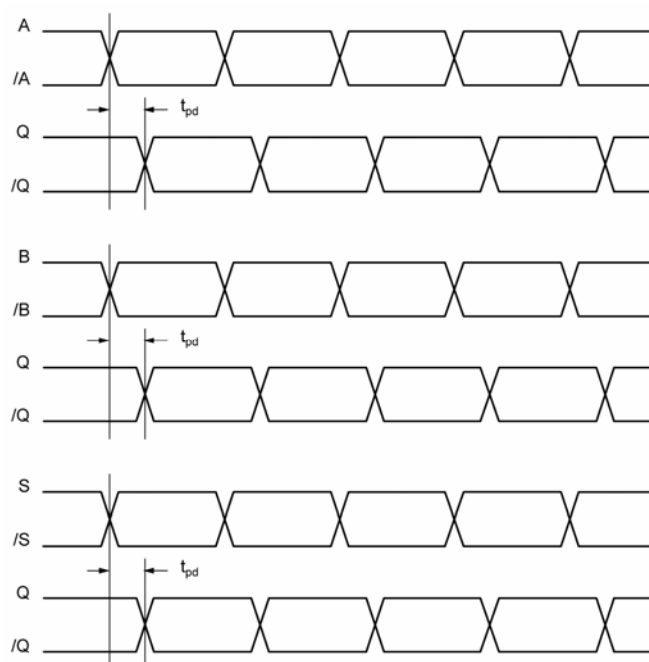

Input and Output Stage Internal Termination

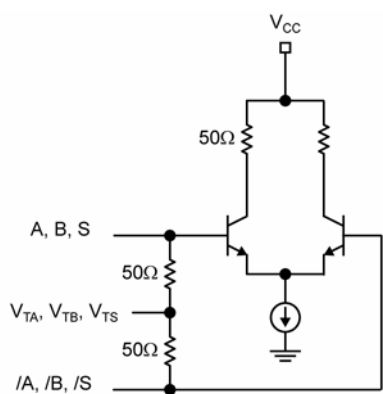

Figure 1a. Simplified Differential Input Stage

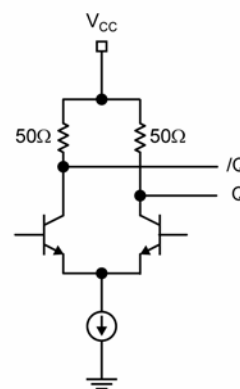

Figure 1b. Simplified Differential Output Stage

Definition of Single-Ended and Differential Swings



Figure 2a. Single-Ended Swing

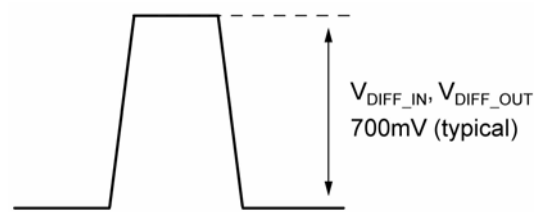
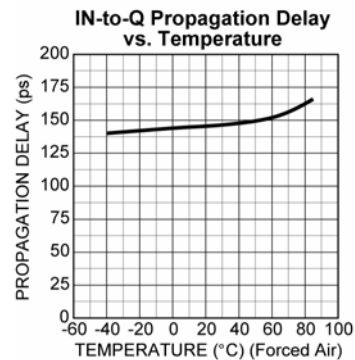
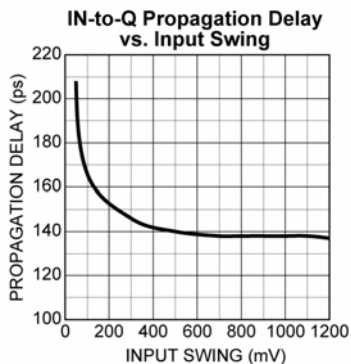
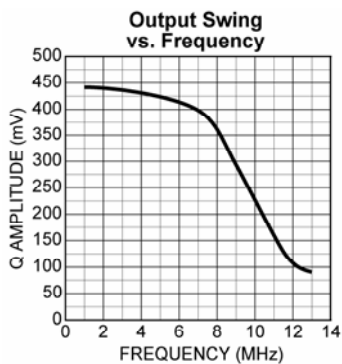
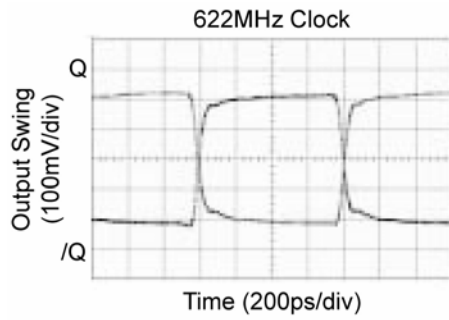

Figure 2b. Differential Swing

Typical Operating Characteristics



Functional Characteristics



10 K28.7 Clock Pattern

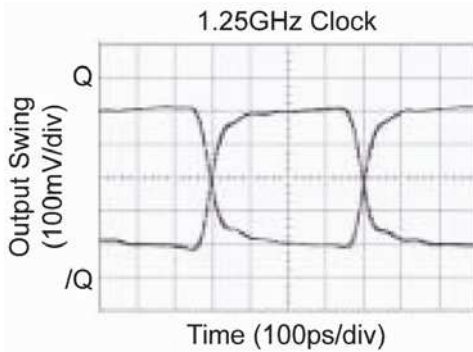

10 K28.7 Clock Pattern

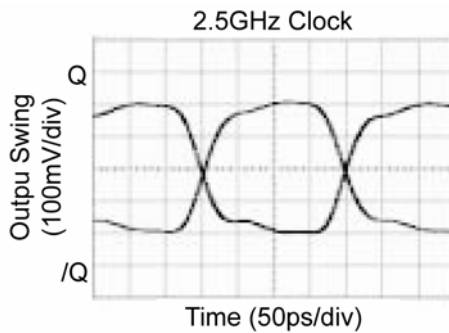

10 K28.7 Clock Pattern

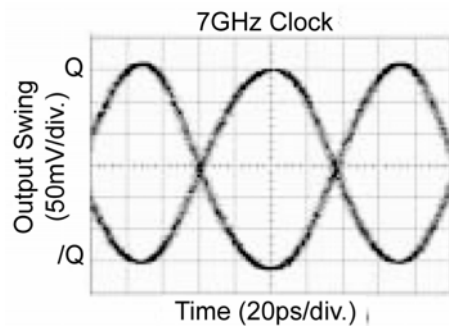

10 K28.7 Clock Pattern

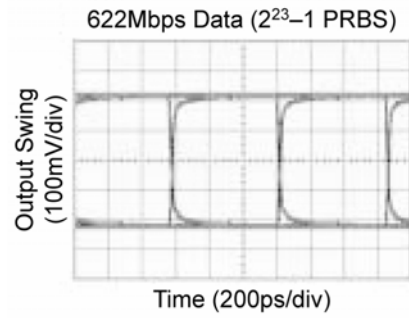

$2^{23}-1$ PRBS Pattern

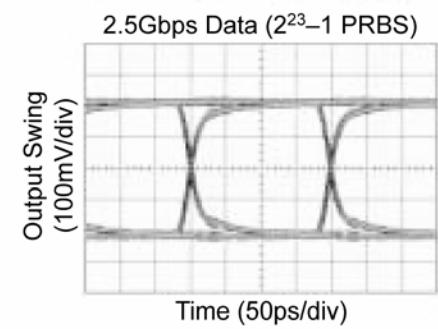

$2^{23}-1$ PRBS Pattern

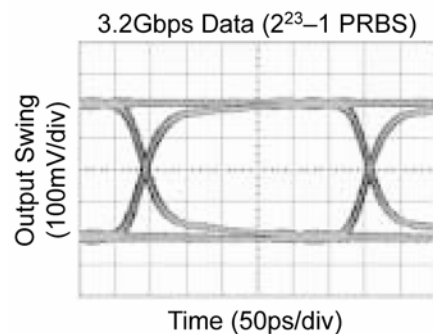

$2^{23}-1$ PRBS Pattern

Input Interface Applications

<p>Input HIGH level shown</p>		
<p>Figure 3a. Static Input Level</p>	<p>Figure 3b. LVDS Interface (DC-Coupled)</p>	<p>Figure 3c. CML Interface (DC-Coupled)</p>
<p>Note: R₁ = 1kΩ, R₂ = 1.4kΩ</p>	<p>Note: R_b = 50Ω</p>	<p>Note: For 3.3V, R_{pd} = 100Ω, R₁ = 1kΩ, R₂ = 1.4kΩ For 2.5V, R_{pd} = 50Ω, R₁ = 1kΩ, R₂ = 1.4kΩ</p>
<p>Figure 3d. CML Interface (AC-Coupled)</p>	<p>Figure 3e. PECL Interface (DC-Coupled)</p>	<p>Figure 3f. PECL Interface (AC-Coupled)</p>

Related Product and Support Documentation

Part Number	Function	Data Sheet Link
SY58016L	3.3V 10Gbps Differential CML Line Driver/Receiver with Internal Termination	http://www.micrel.com/product-info/products/sy58016l.shtml
SY58052U	10Gbps Clock/Data Retimer with 50Ω Input Termination	www.micrel.com/product-info/products/sy58052u.shtml
	QFN® Application Note	www.amkor.com/products/notes_papers/MLF_AppNote_0902.pdf
HBW Solutions	New Products and Applications	www.micrel.com/product-info/products/solutions.shtml

16-PIN *MicroLeadFrame*[®] (MLF-16)

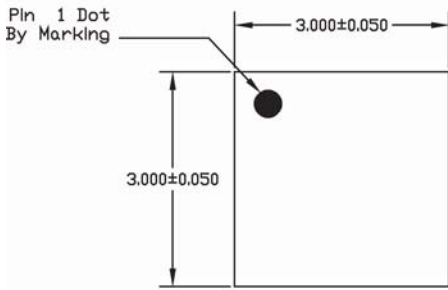

TOP VIEW

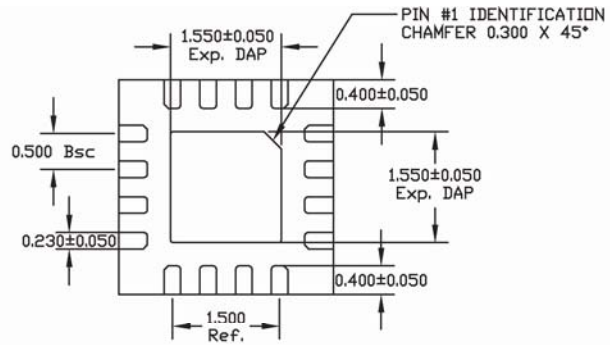

BOTTOM VIEW

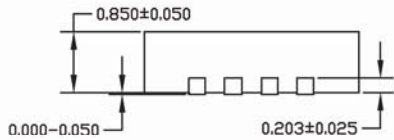

SIDE VIEW

NOTE:

1. ALL DIMENSIONS ARE IN MILLIMETERS.
2. MAX. PACKAGE WARPAGE IS 0.05 mm.
3. MAXIMUM ALLOWABLE BURRS IS 0.076 mm IN ALL DIRECTIONS.
4. PIN #1 ID ON TOP WILL BE LASER/INK MARKED.

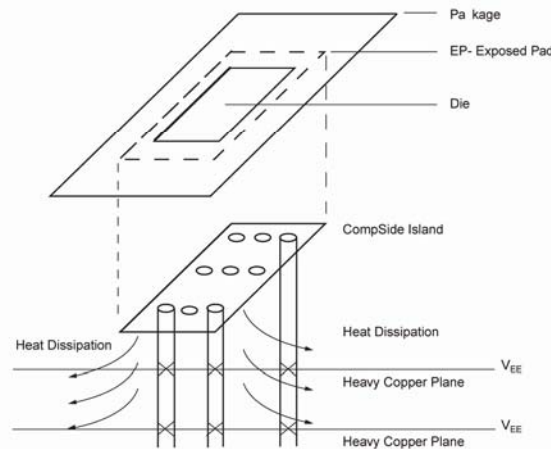

**PCB Thermal Consideration for 16-Pin QFN[®] Package
(Always solder, or equivalent, the exposed pad to the PCB)**

MICREL, INC. 2180 FORTUNE DRIVE SAN JOSE, CA 95131 USA
 TEL +1 (408) 944-0800 FAX +1 (408) 474-1000 WEB <http://www.micrel.com>

Micrel makes no representations or warranties with respect to the accuracy or completeness of the information furnished in this data sheet. This information is not intended as a warranty and Micrel does not assume responsibility for its use. Micrel reserves the right to change circuitry, specifications and descriptions at any time without notice. No license, whether express, implied, arising by estoppel or otherwise, to any intellectual property rights is granted by this document. Except as provided in Micrel's terms and conditions of sale for such products, Micrel assumes no liability whatsoever, and Micrel disclaims any express or implied warranty relating to the sale and/or use of Micrel products including liability or warranties relating to fitness for a particular purpose, merchantability, or infringement of any patent, copyright or other intellectual property right.

Micrel Products are not designed or authorized for use as components in life support appliances, devices or systems where malfunction of a product can reasonably be expected to result in personal injury. Life support devices or systems are devices or systems that (a) are intended for surgical implant into the body or (b) support or sustain life, and whose failure to perform can be reasonably expected to result in a significant injury to the user. A Purchaser's use or sale of Micrel Products for use in life support appliances, devices or systems is a Purchaser's own risk and Purchaser agrees to fully indemnify Micrel for any damages resulting from such use or sale.