



Chipsmall Limited consists of a professional team with an average of over 10 year of expertise in the distribution of electronic components. Based in Hongkong, we have already established firm and mutual-benefit business relationships with customers from,Europe,America and south Asia,supplying obsolete and hard-to-find components to meet their specific needs.

With the principle of “Quality Parts,Customers Priority,Honest Operation,and Considerate Service”,our business mainly focus on the distribution of electronic components. Line cards we deal with include Microchip,ALPS,ROHM,Xilinx,Pulse,ON,Everlight and Freescale. Main products comprise IC,Modules,Potentiometer,IC Socket,Relay,Connector.Our parts cover such applications as commercial,industrial, and automotives areas.

We are looking forward to setting up business relationship with you and hope to provide you with the best service and solution. Let us make a better world for our industry!



Contact us

Tel: +86-755-8981 8866 Fax: +86-755-8427 6832

Email & Skype: info@chipsmall.com Web: www.chipsmall.com

Address: A1208, Overseas Decoration Building, #122 Zhenhua RD., Futian, Shenzhen, China



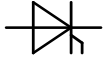

Key Parameters

V_{DRM} / V_{RRM}	4800V ... 5200V
I_{TAVM}	2070A ($T_C=85^\circ\text{C}$)
I_{TSM}	55000A
V_{T0}	0,81V
r_T	0,347m Ω
R_{thJC}	7,0K/kW
Clamping Force	45 ... 65kN
Max. Diameter	121mm
Contact Diameter	86mm
Height	35mm



For type designation please refer to actual shortform catalog

<http://www.ifbip.com/catalog>

Merkmale

- Volle Sperrfähigkeit 50/60Hz über einen weiten Temperaturbereich
- Hohe DC Sperrstabilität
- Hohe Stoßstrombelastbarkeit
- Hoher Gehäusebruchstrom
- Hohe Einschalt di/dt Fähigkeit

Features

- Full blocking 50/60Hz over a wide range temperature range
- High DC blocking stability
- High surge current capability
- High case non-rupture current
- High di/dt capability

Typische Anwendungen

- Mittelspannungssanftanlasser
- Gleichrichter für Antriebsapplikationen
- Mittelspannungsumrichter
- Lastgeführte Umrichter
- Direktumrichter

Typical Applications

- Medium Voltage Softstarter
- Rectifier for Drives Applications
- Medium Voltage Drives
- Load Commutating Inverter
- Cycloconverter

content of customer DMX code	DMX code digit	DMX code digit quantity
serial number	1..7	7
SP material number	8..16	9
datecode (production day)	17..18	2
datecode (production year)	19..20	2
datecode (production month)	21..22	2
vT class	23..26	4
QR class	27..30	4

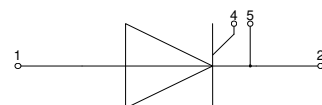

www.ifbip.com
support@infineon-bip.com

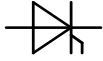

Technische Information / technical information



Infineon Technologies Bipolar
 GmbH & Co. KG

Netz-Thyristor Phase Control Thyristor

T2161N

Elektrische Eigenschaften / electrical properties Höchstzulässige Werte / maximum rated values

Periodische Vorwärts- und Rückwärts-Spitzensperrspannung repetitive peak forward off-state and reverse voltage	$T_{vj} = -40^{\circ}\text{C} \dots T_{vj\text{ max}}$	$V_{\text{DRM}}, V_{\text{RRM}}$	4800 V 5000 V 5200 V
Durchlaßstrom-Grenzeffektivwert maximum RMS on-state current	$T_C = 85^{\circ}\text{C}$	I_{TRMSM}	3250 A
Dauergrenzstrom average on-state current	$T_C = 85^{\circ}\text{C}$ $T_C = 70^{\circ}\text{C}$ $T_C = 55^{\circ}\text{C}$	I_{TAVM}	2070 A 2490 A 2860 A
Stoßstrom-Grenzwert surge current	$T_{vj} = 25^{\circ}\text{C}, t_p = 10\text{ ms}$ $T_{vj} = T_{vj\text{ max}}, t_p = 10\text{ ms}$	I_{TSM}	55000 A 54000 A
Grenzlastintegral I^2t -value	$T_{vj} = 25^{\circ}\text{C}, t_p = 10\text{ ms}$ $T_{vj} = T_{vj\text{ max}}, t_p = 10\text{ ms}$	I^2t	15000 $10^3\text{ A}^2\text{s}$ 14600 $10^3\text{ A}^2\text{s}$
Kritische Stromsteilheit critical rate of rise of on-state current	DIN IEC 60747-6 $f = 50\text{ Hz}, i_{\text{GM}} = 3\text{ A}, di_{\text{G}}/dt = 6\text{ A}/\mu\text{s}$	$(di_{\text{T}}/dt)_{\text{cr}}$	300 $\text{A}/\mu\text{s}$
Kritische Spannungssteilheit critical rate of rise of off-state voltage	$T_{vj} = T_{vj\text{ max}}, V_{\text{D}} = 0,67 V_{\text{DRM}}$ 5.Kennbuchstabe / 5 th letter H	$(dv_{\text{D}}/dt)_{\text{cr}}$	2000 $\text{V}/\mu\text{s}$

Charakteristische Werte / characteristic values

Durchlaßspannung on-state voltage	$T_{vj} = T_{vj\text{ max}}, i_{\text{T}} = 3000\text{ A}$	V_{T}	typ. 1,7 V Max. 1,85 V
Schleusenspannung threshold voltage	$T_{vj} = T_{vj\text{ max}}$	$V_{(\text{TO})}$	typ. 0,7 V max. 0,81 V
Ersatzwiderstand slope resistance	$T_{vj} = T_{vj\text{ max}}$	r_{T}	typ. 0,333 mΩ Max. 0,347 mΩ
Durchlaßkennlinie on-state characteristic $v_{\text{T}} = A + B \cdot i_{\text{T}} + C \cdot \ln(i_{\text{T}} + 1) + D \cdot \sqrt{i_{\text{T}}}$	$T_{vj} = T_{vj\text{ max}}$	typ. max.	A 0,452 B 0,000106 C -0,0063 D 0,0179 A -0,109 B 0,000195 C 0,139 D 0,00471
Zündstrom gate trigger current	$T_{vj} = 25^{\circ}\text{C}, V_{\text{D}} = 12\text{ V}$	I_{GT}	max. 350 mA
Zündspannung gate trigger voltage	$T_{vj} = 25^{\circ}\text{C}, V_{\text{D}} = 12\text{ V}$	V_{GT}	max. 2,5 V
Nicht zündender Steuerstrom gate non-trigger current	$T_{vj} = T_{vj\text{ max}}, V_{\text{D}} = 12\text{ V}$ $T_{vj} = T_{vj\text{ max}}, V_{\text{D}} = 0,5 V_{\text{DRM}}$	I_{GD}	max. 20 mA max. 10 mA
Nicht zündende Steuerspannung gate non-trigger voltage	$T_{vj} = T_{vj\text{ max}}, V_{\text{D}} = 0,5 V_{\text{DRM}}$	V_{GD}	max. 0,4 V
Haltestrom holding current	$T_{vj} = 25^{\circ}\text{C}, V_{\text{D}} = 12\text{ V}$	I_{H}	max. 350 mA
Einraststrom latching current	$T_{vj} = 25^{\circ}\text{C}, V_{\text{D}} = 12\text{ V}, R_{\text{GK}} \geq 10\ \Omega$ $i_{\text{GM}} = 3\text{ A}, di_{\text{G}}/dt = 6\text{ A}/\mu\text{s}, t_{\text{g}} = 20\ \mu\text{s}$	I_{L}	max. 3 A
Vorwärts- und Rückwärts-Sperrstrom forward off-state and reverse current	$T_{vj} = T_{vj\text{ max}}$ $V_{\text{D}} = V_{\text{DRM}}, V_{\text{R}} = V_{\text{RRM}}$	$i_{\text{D}}, i_{\text{R}}$	max. 500 mA
Zündverzug gate controlled delay time	DIN IEC 60747-6 $T_{vj} = 25^{\circ}\text{C}, i_{\text{GM}} = 3\text{ A}, di_{\text{G}}/dt = 6\text{ A}/\mu\text{s}$	t_{gd}	max. 2 μs

prepared by: TM	date of publication: 2011-05-02
approved by: JP	revision: 6.0

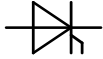

Technische Information / technical information



Infineon Technologies Bipolar
GmbH & Co. KG

Netz-Thyristor Phase Control Thyristor

T2161N

Elektrische Eigenschaften / electrical properties

Charakteristische Werte / characteristic values

Freiwerdezeit circuit commutated turn-off time	$T_{vj} = T_{vj\max}$, $i_{TM} = I_{TAVM}$ $V_{RM} = 100\text{ V}$, $v_{DM} = 0,67 V_{DRM}$ $dv_D/dt = 20\text{ V}/\mu\text{s}$, $-di_T/dt = 10\text{ A}/\mu\text{s}$ 4.Kennbuchstabe / 4 th letter O	t_q	typ.	450	μs
Sperrverzögerungsladung recovered charge	$T_{vj} = T_{vj\max}$ $i_{TM} = I_{TAVM}$, $-di_T/dt = 10\text{ A}/\mu\text{s}$ $V_R = 0,5V_{RRM}$, $V_{RM} = 0,8V_{RRM}$	Q_r	max.	17	mAs
Rückstromspitze peak reverse recovery current	$T_{vj} = T_{vj\max}$ $i_{TM} = I_{TAVM}$, $-di_T/dt = 10\text{ A}/\mu\text{s}$ $V_R = 0,5V_{RRM}$, $V_{RM} = 0,8V_{RRM}$	I_{RM}	max.	360	A

Thermische Eigenschaften / thermal properties

Innerer Wärmewiderstand thermal resistance, junction to case	<u>Kühlfläche / cooling surface</u> beidseitig / two-sided, $\theta = 180^\circ\text{sin}$ beidseitig / two-sided, DC Anode / anode, DC Kathode / cathode, DC	R_{thJC}	max.	7,5	K/kW
			max.	7,0	K/kW
			max.	11,0	K/kW
			max.	19,0	K/kW
Übergangs-Wärmewiderstand thermal resistance, case to heatsink	<u>Kühlfläche / cooling surface</u> beidseitig / two-sided einseitig / single-sided	R_{thCH}	max.	2,0	K/kW
			max.	4,0	K/kW
Höchstzulässige Sperrschichttemperatur maximum junction temperature		$T_{vj\max}$		125	$^\circ\text{C}$
Betriebstemperatur operating temperature		$T_{c\text{ op}}$		-40...+125	$^\circ\text{C}$
Lagertemperatur storage temperature		T_{stg}		-40...+150	$^\circ\text{C}$

Mechanische Eigenschaften / mechanical properties

Gehäuse, siehe Anlage case, see annex				Seite 4 page 4	
Si-Element mit Druckkontakt Si-pellet with pressure contact					
Anpresskraft clamping force		F		45...65	kN
Steueranschlüsse control terminals	DIN 46244	Gate Kathode /Cathode		A 4,8x0,8 A 6,3x0,8	
Gewicht weight		G	typ.	1850	g
Kriechstrecke creepage distance				33	mm
Schwingfestigkeit vibration resistance	f = 50 Hz			50	m/s ²

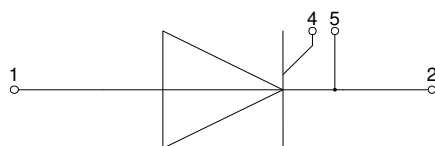
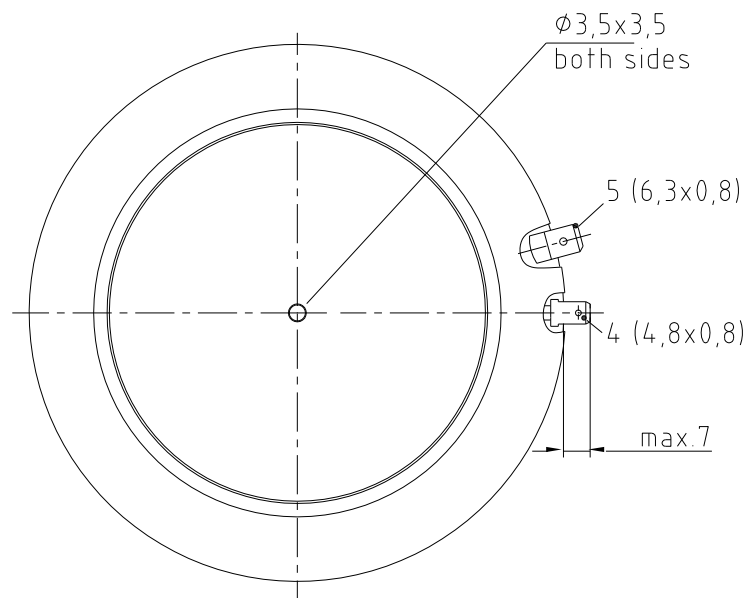
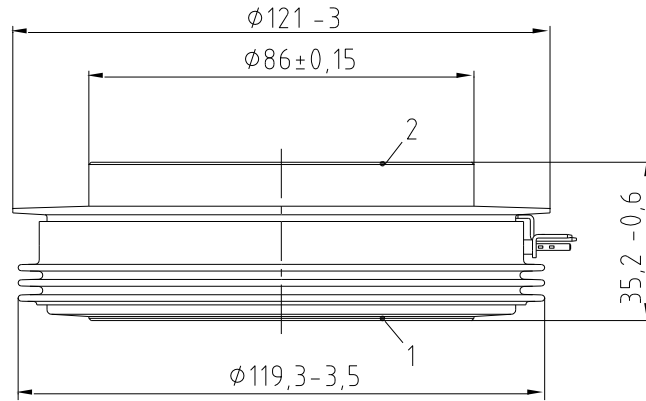
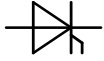

- 1: Anode/anode
- 2: Kathode/cathode
- 4: Gate
- 5: Hilfskathode/
cathode (control terminal)

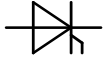

Analytische Elemente des transienten Wärmewiderstandes Z_{thJC} /
analytical elements of transient thermal impedance Z_{thJC}

	Pos. n	1	2	3	4	5	6	7
beidseitig two-sided	R_{thn} [K/kW]	1,6	1,8	0,83	2,3	0,47		
	τ_n [s]	2,6	0,32	0,16	0,1	0,004		
anodenseitig anode-sided	R_{thn} [K/kW]	5,2	2,2	0,83	2,3	0,47		
	τ_n [s]	8,15	0,4	0,16	0,1	0,004		
kathodenseitig cathode-sided	R_{thn} [K/kW]	11,4	4	0,83	2,3	0,47		
	τ_n [s]	16,8	0,73	0,16	0,1	0,004		

Analytische Funktion / analytical function:

$$Z_{thJC} = \sum_{n=1}^{n_{max}} R_{thn} \left(1 - e^{-\frac{t}{\tau_n}} \right)$$

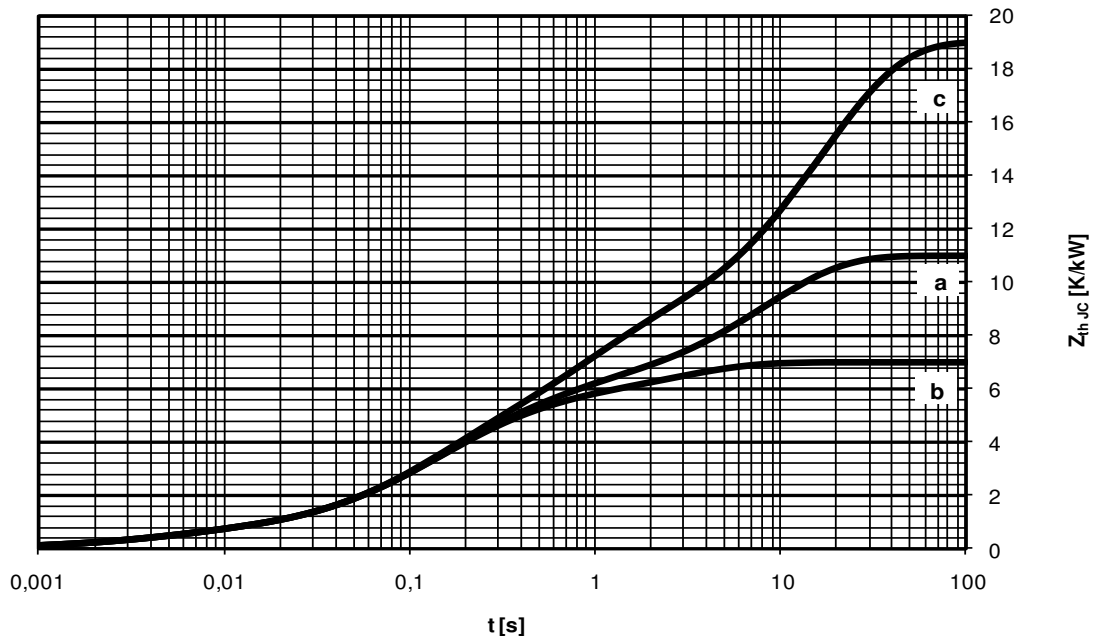

Transienter innerer Wärmewiderstand für DC / transient thermal impedance $Z_{thJC} = f(t)$ for DC

a : Anodenseitige Kühlung / anode-sided cooling

b : Beidseitige Kühlung / two-sided cooling

c : Kathodenseitige Kühlung / cathode-sided cooling

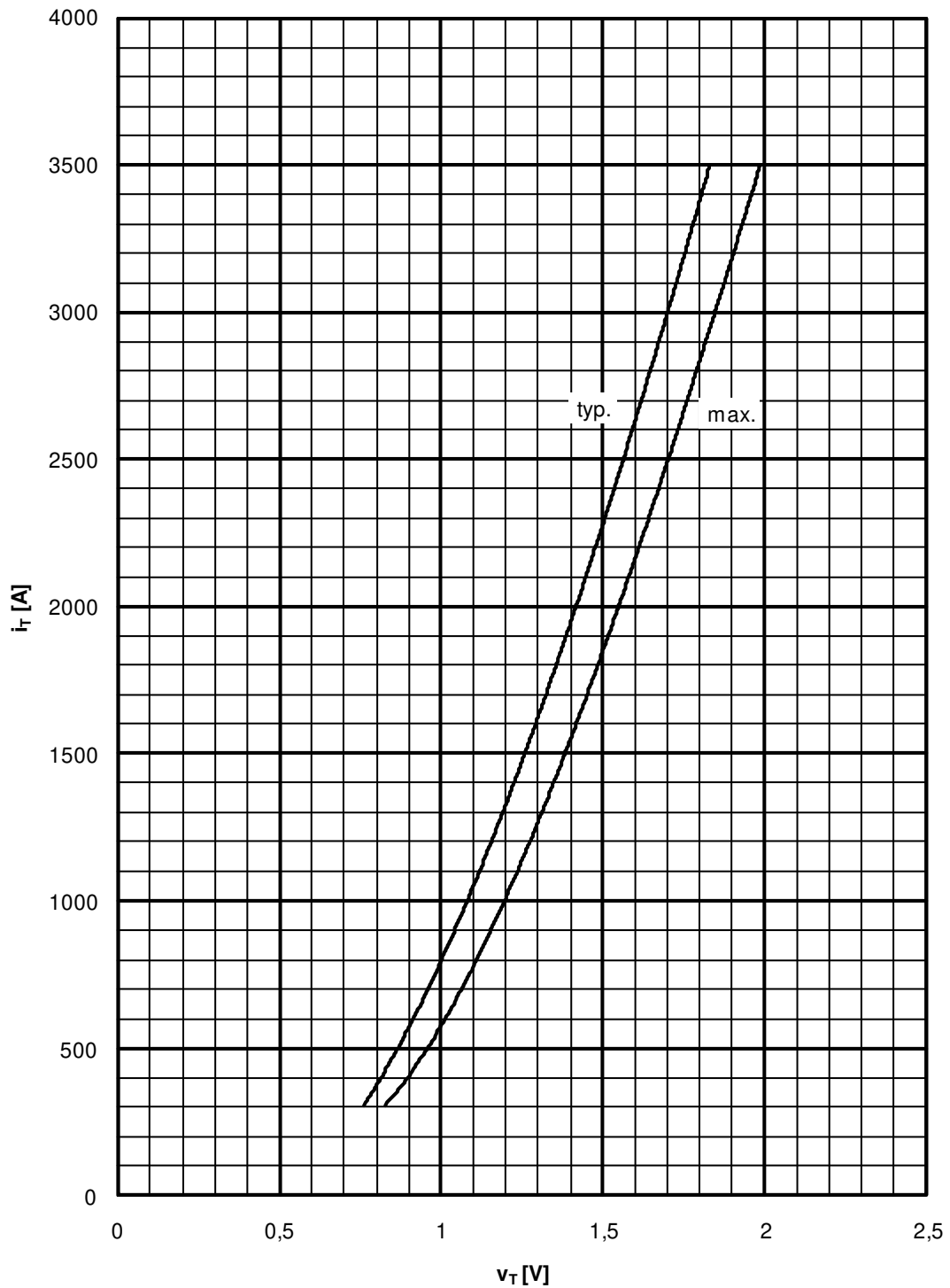
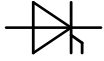

Grenzdurchlaßkennlinie / limiting on-state characteristic $i_T = f(v_T)$

$$T_{vj} = T_{vj \text{ max}}$$

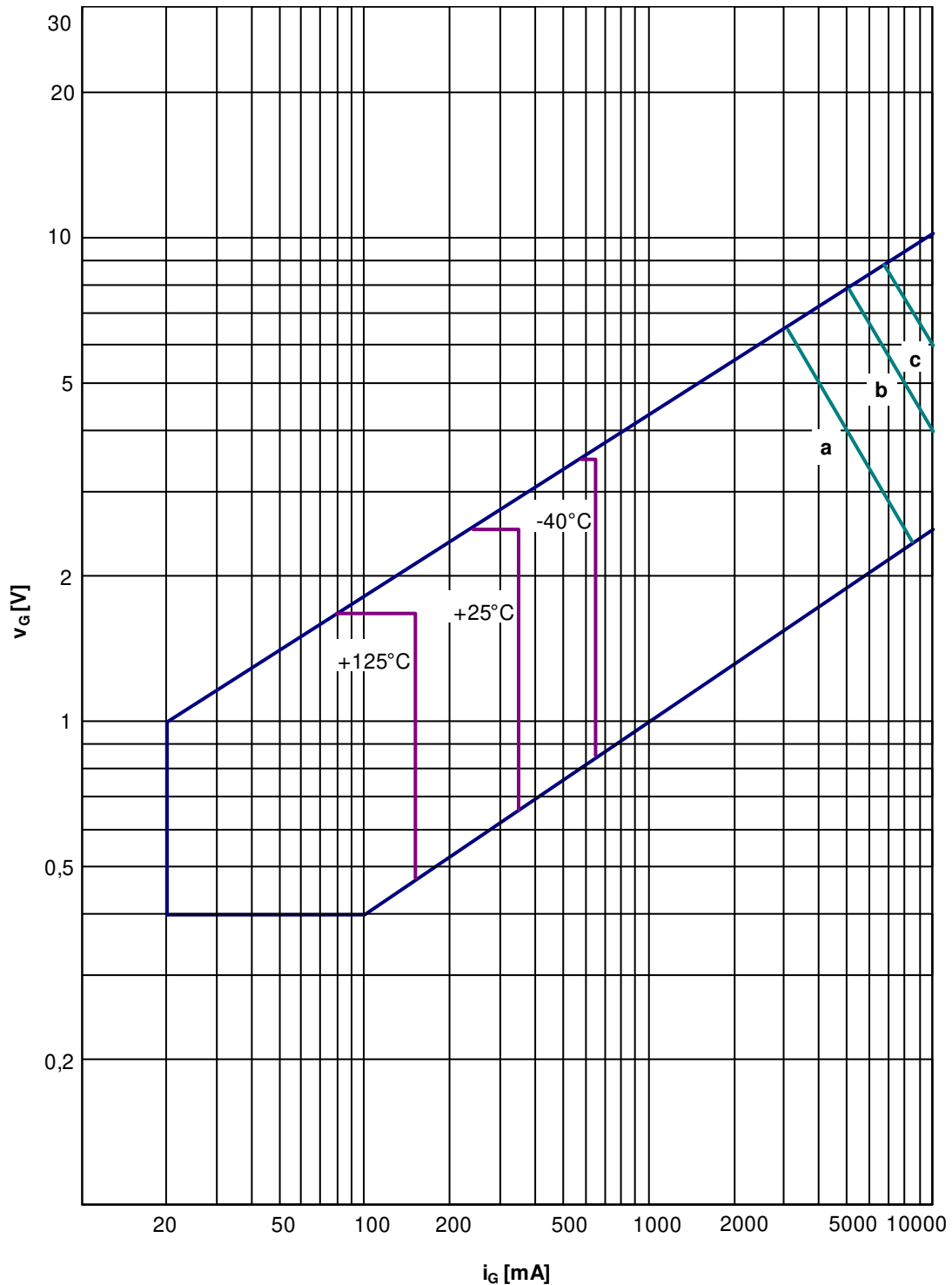
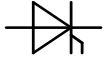

Steuercharakteristik $v_G = f(i_G)$ mit Zündbereichen für $V_D = 12$ V /
gate characteristic $v_G = f(i_G)$ with triggering area for $V_D = 12$ V

Höchstzulässige Spitzensteuerverlustleistung / maximum rated peak gate power dissipation $P_{GM} = f(t_g)$:

a - 20 W/10ms b - 40 W/1ms c - 60 W/0,5ms

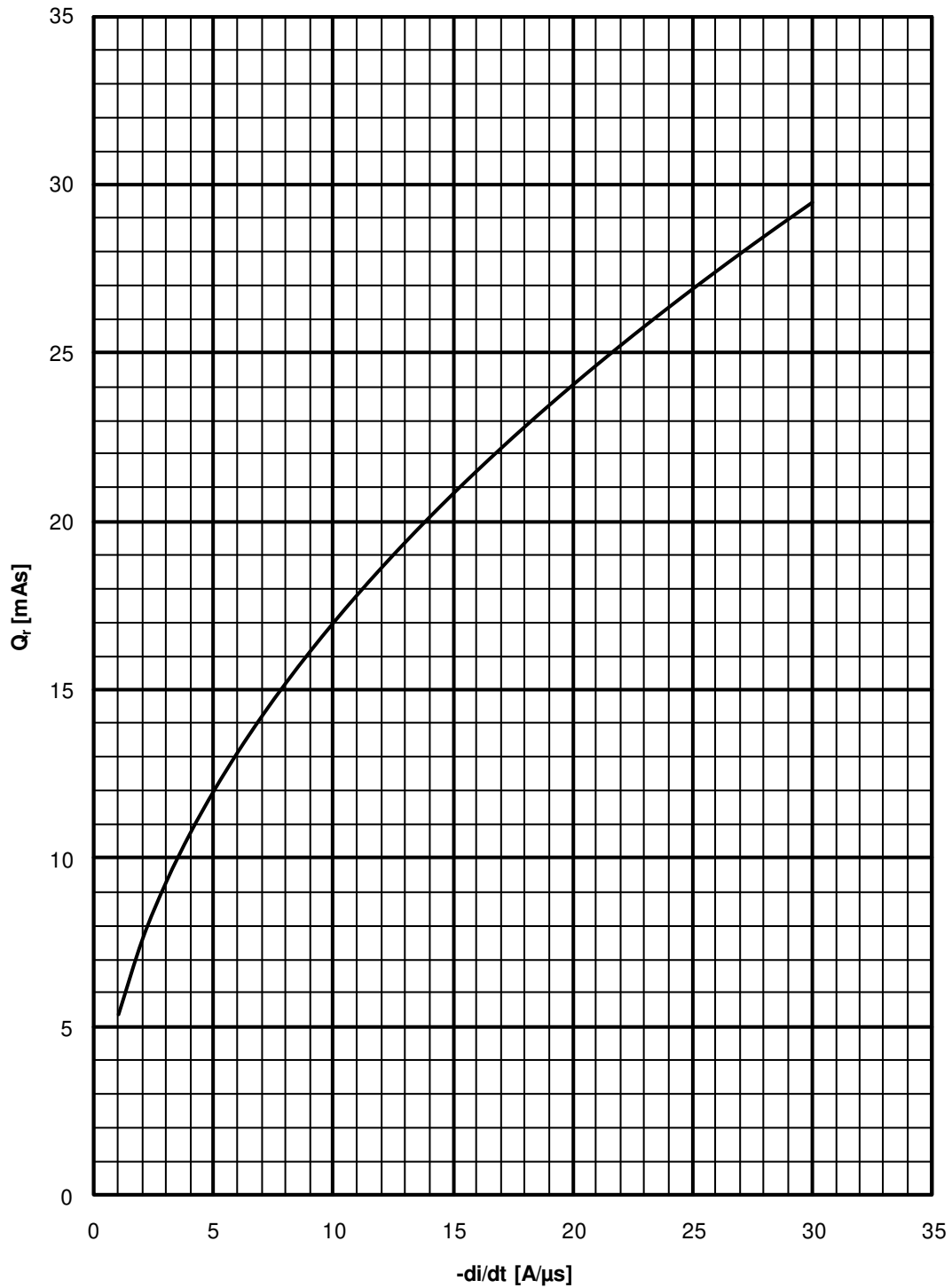
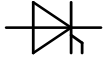

Sperrverzögerungsladung / recovered charge $Q_r = f(-di/dt)$

$$T_{vj} = T_{vjmax}, V_R = 0,5 V_{RRM}, V_{RM} = 0,8 V_{RRM}$$

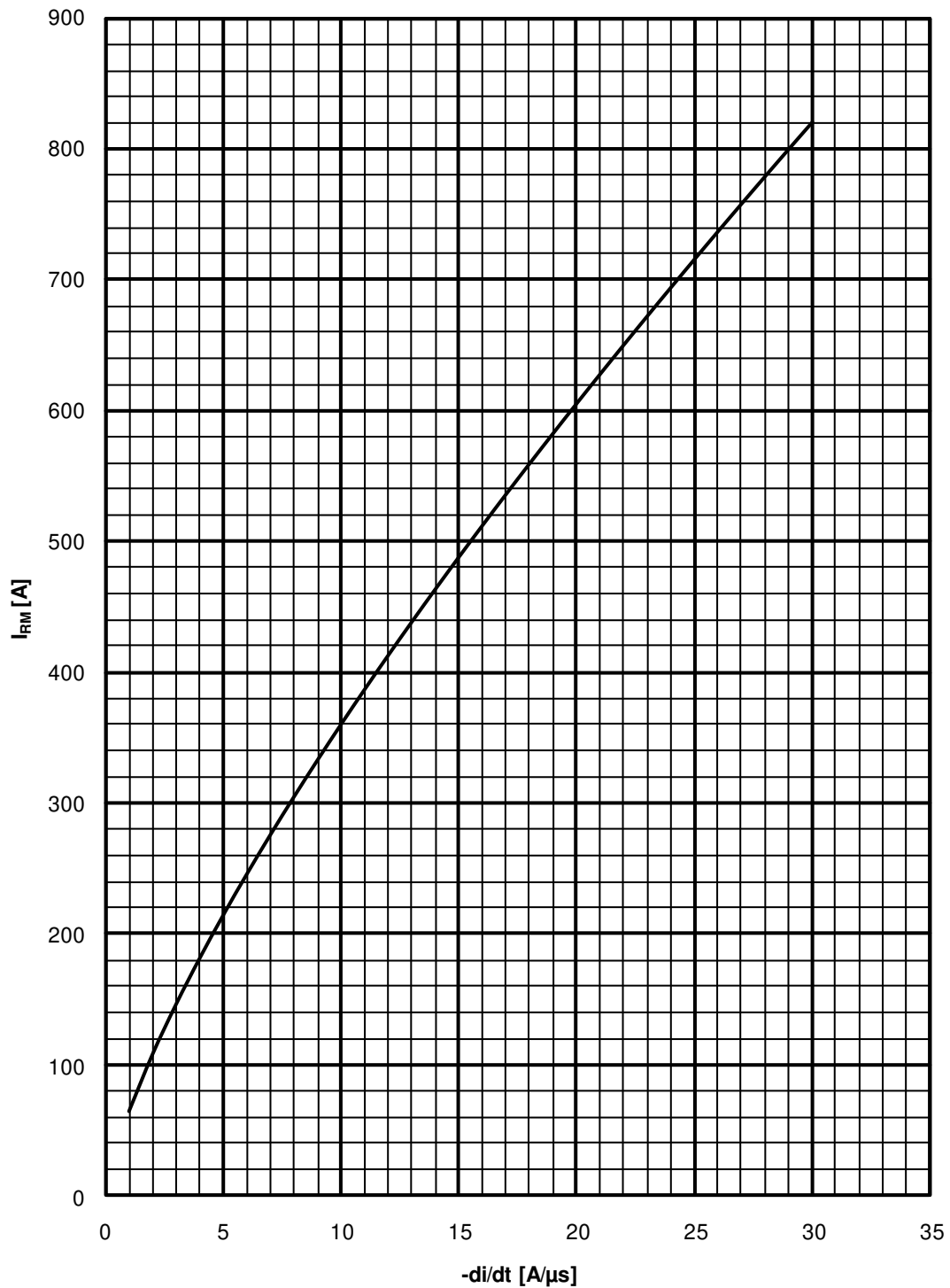
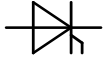

Rückstromspitze / peak reverse recovery current $I_{RM} = f(-di/dt)$

$T_{vj} = T_{vjmax}$, $v_R = 0,5 V_{RRM}$, $V_{RM} = 0,8 V_{RRM}$

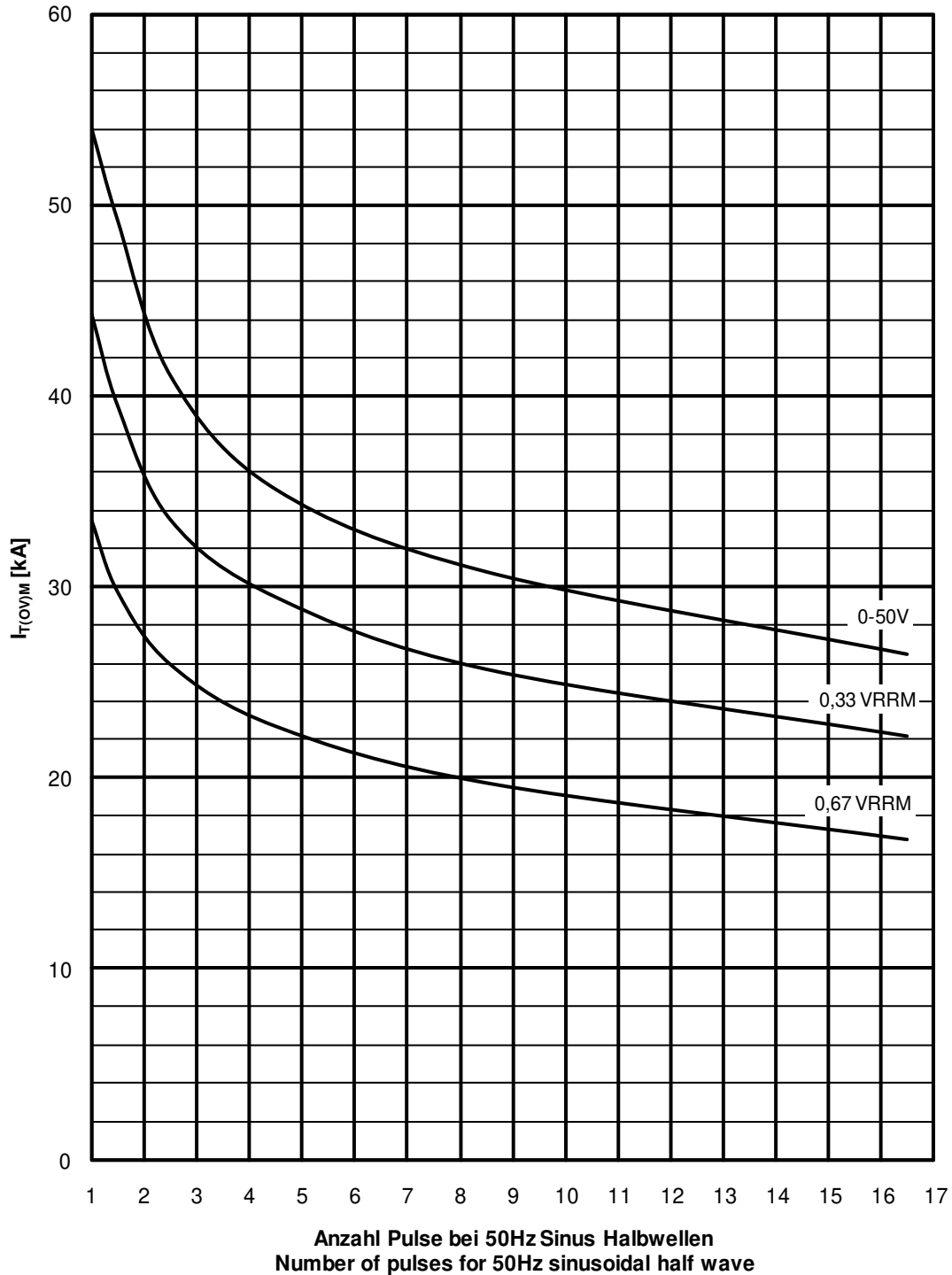
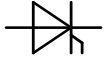

Typische Abhängigkeit des Grenzstromes $I_{T(OV)M}$ von der Anzahl für eine Folge von Sinus Halbwellen bei 50Hz.

Parameter: Rückwärtsspannung V_{RM}

Typical dependency of maximum overload on-state current $I_{T(OV)M}$ as a number of a sequence of sinusoidal half waves at 50Hz. Parameter: peak reverse voltage V_{RM}

$I_{T(OV)M} = f(\text{pulses}, V_{RM}) ; T_{vj} = T_{vjmax}$

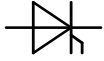

Nutzungsbedingungen

Die in diesem Produktdatenblatt enthaltenen Daten sind ausschließlich für technisch geschultes Fachpersonal bestimmt. Die Beurteilung der Geeignetheit dieses Produktes für die von Ihnen anvisierte Anwendung sowie die Beurteilung der Vollständigkeit der bereitgestellten Produktdaten für diese Anwendung obliegt Ihnen bzw. Ihren technischen Abteilungen.

In diesem Produktdatenblatt werden diejenigen Merkmale beschrieben, für die wir eine liefervertragliche Gewährleistung übernehmen. Eine solche Gewährleistung richtet sich ausschließlich nach Maßgabe der im jeweiligen Liefervertrag enthaltenen Bestimmungen. Garantien jeglicher Art werden für das Produkt und dessen Eigenschaften keinesfalls übernommen.

Sollten Sie von uns Produktinformationen benötigen, die über den Inhalt dieses Produktdatenblatts hinausgehen und insbesondere eine spezifische Verwendung und den Einsatz dieses Produktes betreffen, setzen Sie sich bitte mit dem für Sie zuständigen Vertriebsbüro in Verbindung (siehe www.infineon.com). Für Interessenten halten wir Application Notes bereit.

Aufgrund der technischen Anforderungen könnte unser Produkt gesundheitsgefährdende Substanzen enthalten. Bei Rückfragen zu den in diesem Produkt jeweils enthaltenen Substanzen setzen Sie sich bitte ebenfalls mit dem für Sie zuständigen Vertriebsbüro in Verbindung.

Sollten Sie beabsichtigen, das Produkt in Anwendungen der Luftfahrt, in gesundheits- oder lebensgefährdenden oder lebenserhaltenden Anwendungsbereichen einzusetzen, bitten wir um Mitteilung. Wir weisen darauf hin, dass wir für diese Fälle

- die gemeinsame Durchführung eines Risiko- und Qualitätsassessments;
- den Abschluss von speziellen Qualitätssicherungsvereinbarungen;
- die gemeinsame Einführung von Maßnahmen zu einer laufenden Produktbeobachtung dringend empfehlen und gegebenenfalls die Belieferung von der Umsetzung solcher Maßnahmen abhängig machen.

Soweit erforderlich, bitten wir Sie, entsprechende Hinweise an Ihre Kunden zu geben.

Inhaltliche Änderungen dieses Produktdatenblatts bleiben vorbehalten.

Terms & Conditions of usage

The data contained in this product data sheet is exclusively intended for technically trained staff. You and your technical departments will have to evaluate the suitability of the product for the intended application and the completeness of the product data with respect to such application.

This product data sheet is describing the characteristics of this product for which a warranty is granted. Any such warranty is granted exclusively pursuant the terms and conditions of the supply agreement. There will be no guarantee of any kind for the product and its characteristics.

Should you require product information in excess of the data given in this product data sheet or which concerns the specific application of our product, please contact the sales office, which is responsible for you (see www.infineon.com). For those that are specifically interested we may provide application notes.

Due to technical requirements our product may contain dangerous substances. For information on the types in question please contact the sales office, which is responsible for you.

Should you intend to use the Product in aviation applications, in health or life endangering or life support applications, please notify. Please note, that for any such applications we urgently recommend

- to perform joint Risk and Quality Assessments;
- the conclusion of Quality Agreements;
- to establish joint measures of an ongoing product survey, and that we may make delivery depended on the realization of any such measures.

If and to the extent necessary, please forward equivalent notices to your customers.

Changes of this product data sheet are reserved.