



Chipsmall Limited consists of a professional team with an average of over 10 year of expertise in the distribution of electronic components. Based in Hongkong, we have already established firm and mutual-benefit business relationships with customers from,Europe,America and south Asia,supplying obsolete and hard-to-find components to meet their specific needs.

With the principle of “Quality Parts,Customers Priority,Honest Operation,and Considerate Service”,our business mainly focus on the distribution of electronic components. Line cards we deal with include Microchip,ALPS,ROHM,Xilinx,Pulse,ON,Everlight and Freescale. Main products comprise IC,Modules,Potentiometer,IC Socket,Relay,Connector.Our parts cover such applications as commercial,industrial, and automotives areas.

We are looking forward to setting up business relationship with you and hope to provide you with the best service and solution. Let us make a better world for our industry!



Contact us

Tel: +86-755-8981 8866 Fax: +86-755-8427 6832

Email & Skype: info@chipsmall.com Web: www.chipsmall.com

Address: A1208, Overseas Decoration Building, #122 Zhenhua RD., Futian, Shenzhen, China



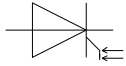

**Netz-Thyristor
Phase Control Thyristor**

T2563N

Key Parameters

V_{BO} / V_{RRM}	7500V / 8000V
I_{TAVM}	2300A ($T_C=85^\circ\text{C}$)
I_{TSM}	93000A
V_{TO}	1,2V
r_T	0,35m Ω
R_{thJC}	4,5K/kW
Clamping Force	90 ... 130kN
Max. Diameter	172,5mm
Contact Diameter	115mm
Height	40mm



For type designation please refer to actual shortform catalog

<http://www.ifbip.com/catalog>

Merkmale

- Direkt lichtgezündeter Thyristor mit integrierter Schutzfunktion
- Volle Sperrfähigkeit 50/60Hz über einen weiten Temperaturbereich
- Hohe DC Sperrstabilität
- Hohe Stoßstrombelastbarkeit
- Hohe Einschalt di/dt Fähigkeit

Features

- Light triggered thyristor with internal Break over Diode
- Full blocking 50/60Hz over a wide range temperature range
- High DC blocking stability
- High surge current capability
- High di/dt capability

Typische Anwendungen

- Hochspannungs-Gleichstrom- Übertragung HGÜ
- Statische Kompensation SVC
- Mittelspannungsumrichter
- Kurzschließer-Applikationen
- Pulsed Power Applikationen

Typical Applications

- High Voltage Direct Current Transmission HVDC
- Static Var Compensation SVC
- Medium Voltage Drives
- Crowbar Applications
- Pulsed Power Applications



content of customer DMX code	DMX code digit	DMX code digit quantity
serial number	1..7	7
SP material number	8..16	9
datecode (production day)	17..18	2
datecode (production year)	19..20	2
datecode (production month)	21..22	2
vT class	23..26	4
QR class	27..30	4

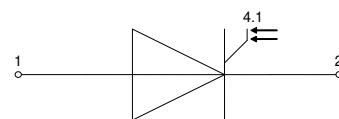

www.ifbip.com
support@infineon-bip.com

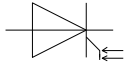

Technische Information / technical information



Infineon Technologies Bipolar
 GmbH & Co. KG

Netz-Thyristor Phase Control Thyristor

T2563N

Elektrische Eigenschaften / electrical properties Höchstzulässige Werte / maximum rated values

Periodische Rückwärts-Spitzensperrspannung repetitive peak and reverse voltage	$T_{vj} = -40^{\circ}\text{C} \dots T_{vj \max}$	V_{RRM}	7500 V 8000 V
Durchlaßstrom-Effektivwert maximum RMS on-state current	$T_C = 85^{\circ}\text{C}$	I_{TRMSM}	3600 A
Dauergrenzstrom average on-state current	$T_C = 85^{\circ}\text{C}$ $T_C = 70^{\circ}\text{C}$ $T_C = 55^{\circ}\text{C}$	I_{TAVM}	2300 A 2850 A 3330 A
Stoßstrom-Grenzwert surge current	$T_{vj} = 25^{\circ}\text{C}, t_p = 10 \text{ ms}$ $T_{vj} = T_{vj \max}, t_p = 10 \text{ ms}$	I_{TSM}	93000 A 90000 A
Grenzlastintegral I^2t -value	$T_{vj} = 25^{\circ}\text{C}, t_p = 10 \text{ ms}$ $T_{vj} = T_{vj \max}, t_p = 10 \text{ ms}$	I^2t	43250 $10^3 \text{ A}^2\text{s}$ 40500 $10^3 \text{ A}^2\text{s}$
Kritische Stromsteilheit critical rate of rise of on-state current	DIN IEC 60747-6 $f = 50 \text{ Hz}, P_{LM} = 40\text{mW}, t_{rise} = 0,5\mu\text{s}$	$(di_T/dt)_{cr}$	300 $\text{A}/\mu\text{s}$
Kritische Spannungssteilheit critical rate of rise of off-state voltage	$T_{vj} = T_{vj \max}, V_D = 0,67 V_{DRM}$ 5.Kennbuchstabe / 5 th letter H	$(dv_D/dt)_{cr}$	2000 $\text{V}/\mu\text{s}$

Charakteristische Werte / characteristic values

Schutzzündspannung (statisch) protective break over voltage	$T_{vj} = 25^{\circ}\text{C} \dots T_{vj \max}$ Typischer Degradationsfaktor ist 0,16%/K für $T_{vj} = 0^{\circ}\text{C}..25^{\circ}\text{C}$ Typical de-rating factor of 0,16%/K is applicable for $T_{vj} = 0^{\circ}\text{C}..25^{\circ}\text{C}$	V_{BO}	min. 7500 V
Durchlaßspannung on-state voltage	$T_{vj} = T_{vj \max}, i_T = 5000\text{A}, V_D = 150\text{V}$	V_T	typ. 2,75 V max. 2,95 V
Schleusenspannung threshold voltage	$T_{vj} = T_{vj \max}$	$V_{(TO)}$	typ. 1,12 V max. 1,20 V
Ersatzwiderstand slope resistance	$T_{vj} = T_{vj \max}$	r_T	typ. 0,326 $\text{m}\Omega$ max. 0,350 $\text{m}\Omega$
Durchlaßkennlinie on-state characteristic $v_T = A + B \cdot i_T + C \cdot \ln(i_T + 1) + D \cdot \sqrt{i_T}$	$T_{vj} = T_{vj \max}$ $500\text{A} \leq i_F \leq 6000\text{A}$	typ. max.	A 1,2357 B -2,89E-05 C -0,1322 D 0,03946 A 1,2406 B -2,253E-05 C -0,1232 D 0,04056
minimale Zündlichtleistung minimum gate trigger light power	$T_{vj} = 25^{\circ}\text{C}, V_D = 150\text{V}$	P_{LM}	max. 40 mW
Haltestrom holding current	$T_{vj} = 25^{\circ}\text{C}$	I_H	max. 100 mA
Einraststrom latching current	$T_{vj} = 25^{\circ}\text{C}, V_D = 150\text{V},$ $P_{LM} = 40\text{mW}, t_{rise} = 0,5\mu\text{s}$	I_L	max. 1 A
Rückwärts-Sperrstrom reverse blocking current	$T_{vj} = T_{vj \max}$ $V_R = V_{RRM}$	i_R	max. 900 mA
Zündverzug gate controlled delay time	DIN IEC 60747-6 $T_{vj} = 25^{\circ}\text{C}, v_D = 1000\text{V},$ $P_{LM} = 40\text{mW}, t_{rise} = 0,5\mu\text{s}$	t_{gd}	max. 5 μs

prepared by: TM	date of publication: 2011-05-02
approved by: JP	revision: 11.0

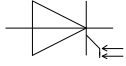

**Technische Information /
technical information**



Infineon Technologies Bipolar
GmbH & Co. KG

**Netz-Thyristor
Phase Control Thyristor**

T2563N

Elektrische Eigenschaften / electrical properties
Charakteristische Werte / characteristic values

Freiwerdezeit circuit commutated turn-off time	$T_{vj} = T_{vj\max}$, $i_{TM} = I_{TAVM}$ $V_{RM} = 100\text{ V}$, $v_{DM} = 0,67 V_{DRM}$ $dv_D/dt = 20\text{ V}/\mu\text{s}$, $-di_T/dt = 10\text{ A}/\mu\text{s}$ 4.Kennbuchstabe / 4 th letter O	t_q	typ.	550	μs
Sperrverzögerungsladung recovered charge	$T_{vj} = T_{vj\max}$ $i_{TM} = I_{TAVM}$, $-di_T/dt = 10\text{ A}/\mu\text{s}$ $V_R = 0,5V_{RRM}$, $V_{RM} = 0,8V_{RRM}$	Q_r	max.	22	mAs
Rückstromspitze peak reverse recovery current	$T_{vj} = T_{vj\max}$ $i_{TM} = I_{TAVM}$, $-di_T/dt = 10\text{ A}/\mu\text{s}$ $V_R = 0,5V_{RRM}$, $V_{RM} = 0,8V_{RRM}$	I_{RM}	max.	400	A

Thermische Eigenschaften / thermal properties

Innerer Wärmewiderstand thermal resistance, junction to case	<u>Kühlfläche / cooling surface</u> beidseitig / two-sided, $\theta = 180^\circ\text{sin}$ beidseitig / two-sided, DC Anode / anode, DC Kathode / cathode, DC	R_{thJC}	max.	4,8	K/kW
			max.	4,5	K/kW
			max.	8,2	K/kW
			max.	10,0	K/kW
Übergangs-Wärmewiderstand thermal resistance, case to heatsink	<u>Kühlfläche / cooling surface</u> beidseitig / two-sided einseitig / single-sided	R_{thCH}	max.	1,0	K/kW
			max.	2,0	K/kW
Höchstzulässige Sperrschichttemperatur maximum junction temperature		$T_{vj\max}$		120	$^\circ\text{C}$
Betriebstemperatur operating temperature		$T_{c\text{ op}}$		-40...+120	$^\circ\text{C}$
Lagertemperatur storage temperature		T_{stg}		-40...+150	$^\circ\text{C}$

Mechanische Eigenschaften / mechanical properties

Gehäuse, siehe Anlage case, see annex				Seite 4 page 4	
Si-Element mit Druckkontakt Si-pellet with pressure contact					
Anpresskraft clamping force		F		90...130	kN
Gewicht weight		G	typ.	4000	g
Kriechstrecke creepage distance				49	mm
Schwingfestigkeit vibration resistance	f = 50 Hz			50	m/s ²

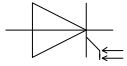

Technische Information /
technical information



Netz-Thyristor
Phase Control Thyristor

T2563N

Infineon Technologies Bipolar
GmbH & Co. KG

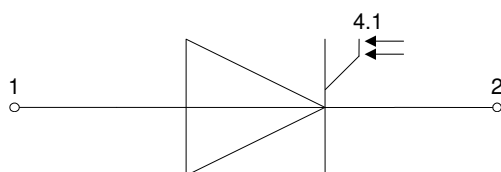
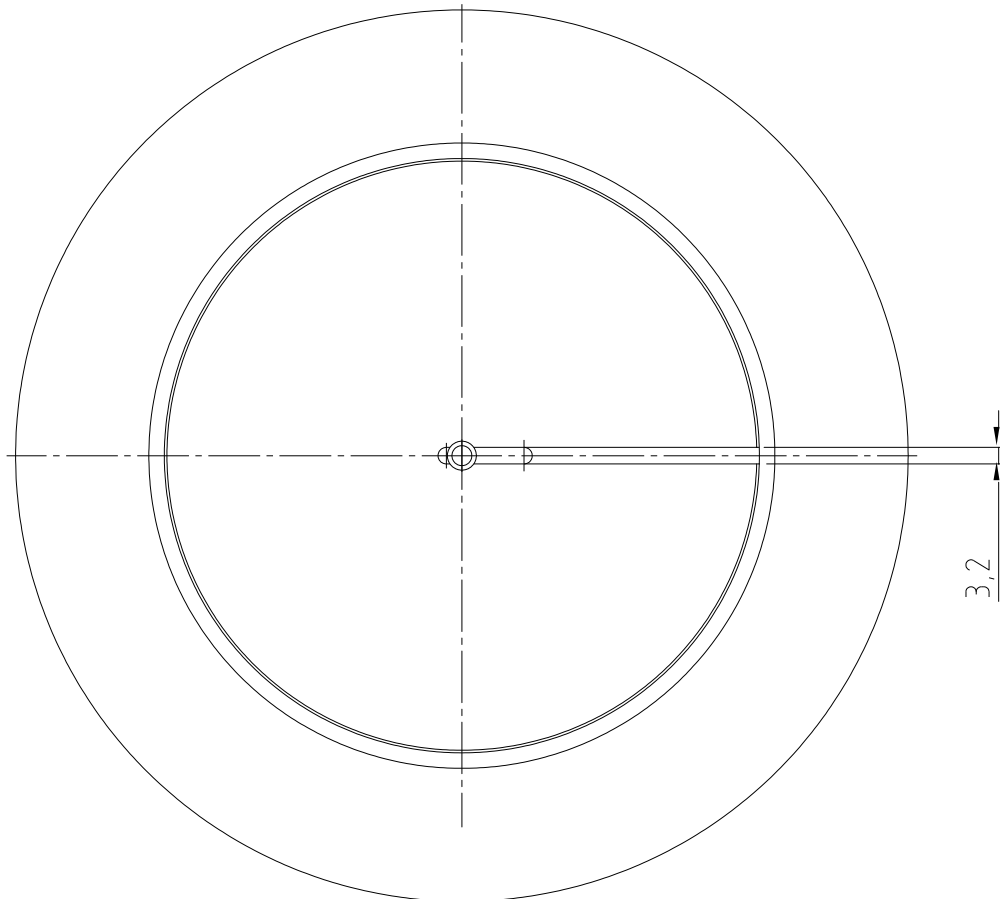
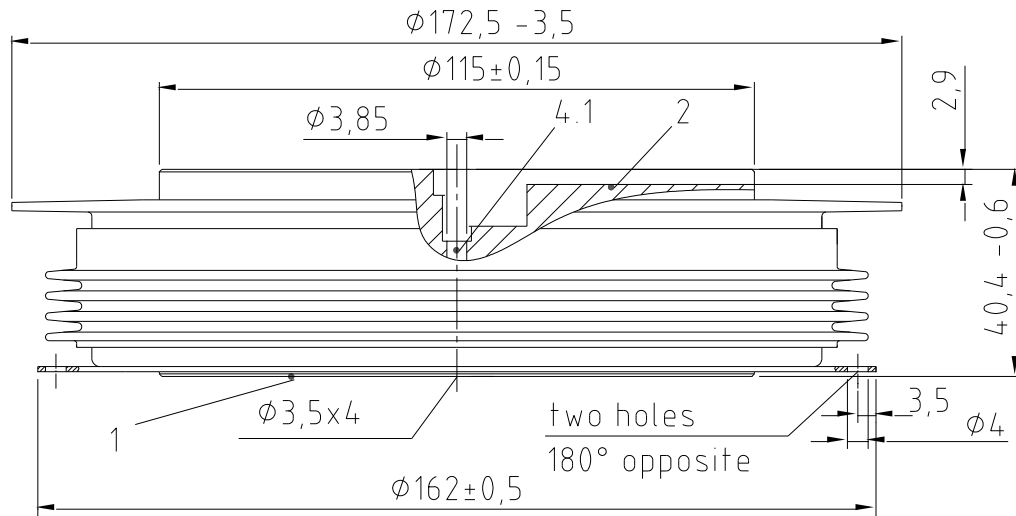

- 1: Anode/anode
- 2: Kathode/cathode
- 4.1: Gate

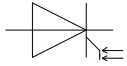

Analytische Elemente des transienten Wärmewiderstandes Z_{thJC} /
analytical elements of transient thermal impedance Z_{thJC}

	Pos. n	1	2	3	4	5	6	7
beidseitig two-sided	R_{thn} [K/kW]	2,06	1,6	0,76	0,080			
	τ_n [s]	1,6	0,27	0,026	0,0054			
anodenseitig anode-sided	R_{thn} [K/kW]	4,67	1,84	1,31	0,38			
	τ_n [s]	11,128	1,0396	0,09265	0,01079			
kathodenseitig cathode-sided	R_{thn} [K/kW]	6,66	1,64	1,24	0,46			
	τ_n [s]	8,2498	1,2122	0,1124	0,0119			

Analytische Funktion / analytical function:
$$Z_{thJC} = \sum_{n=1}^{n_{max}} R_{thn} \left(1 - e^{-\frac{t}{\tau_n}} \right)$$

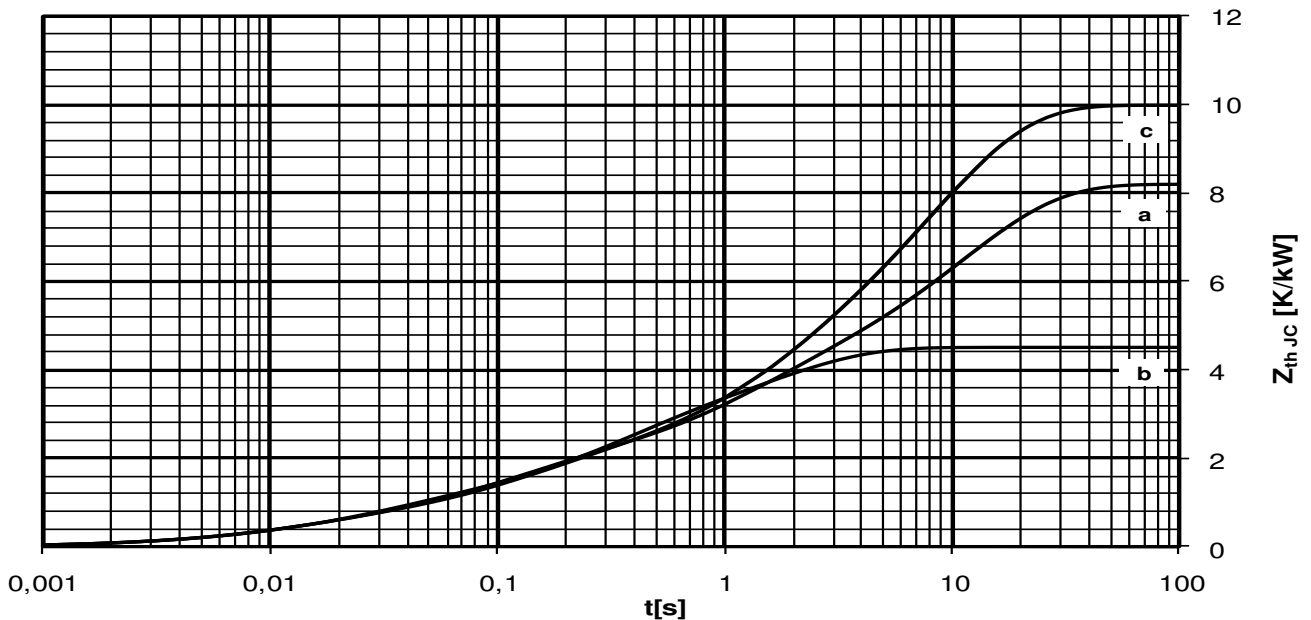

Transienter innerer Wärmewiderstand für DC / transient thermal impedance $Z_{thJC} = f(t)$ for DC

a : Anodenseitige Kühlung / anode-sided cooling

b : Beidseitige Kühlung / two-sided cooling

c : Kathodenseitige Kühlung / cathode-sided cooling

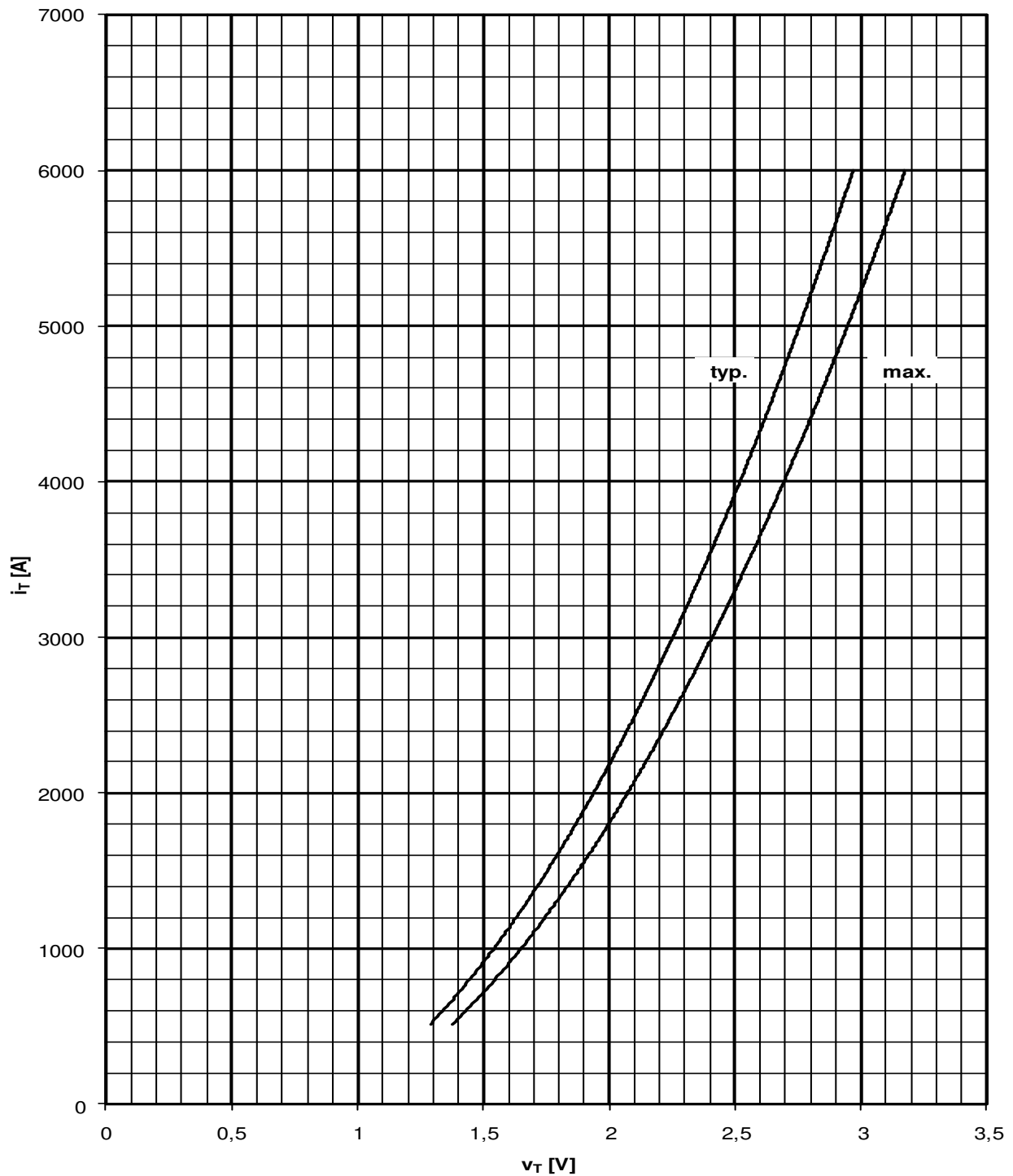
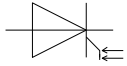

Grenzdurchlaßkennlinie / limiting on-state characteristic $i_T = f(v_T)$

$$T_{vj} = T_{vj \text{ max}}$$

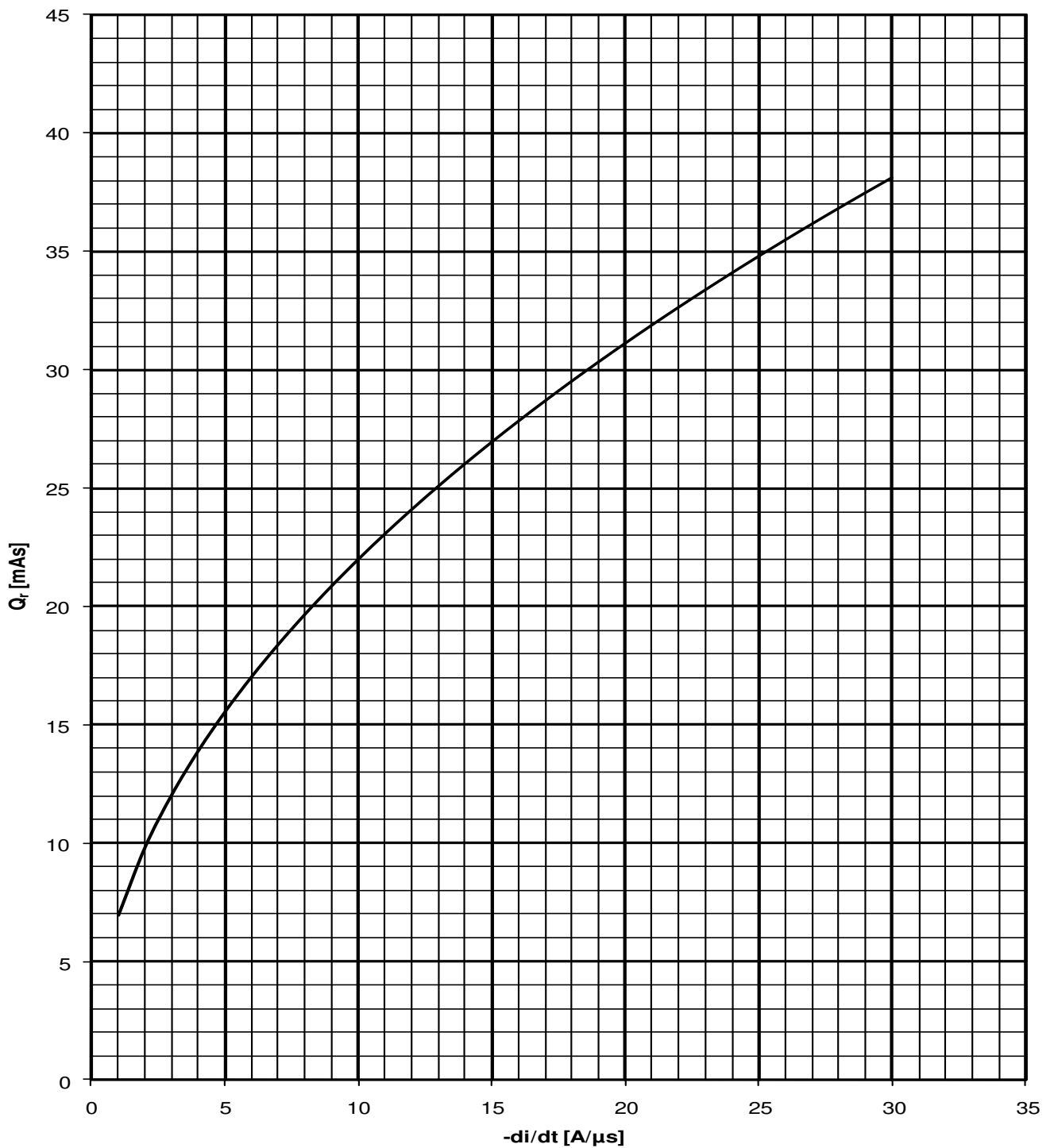
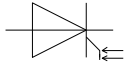

Sperrverzögerungsladung / recovered charge $Q_r = f(-di/dt)$

$$T_{vj} = T_{vjmax}, V_R = 0,5 V_{RRM}, V_{RM} = 0,8 V_{RRM}$$

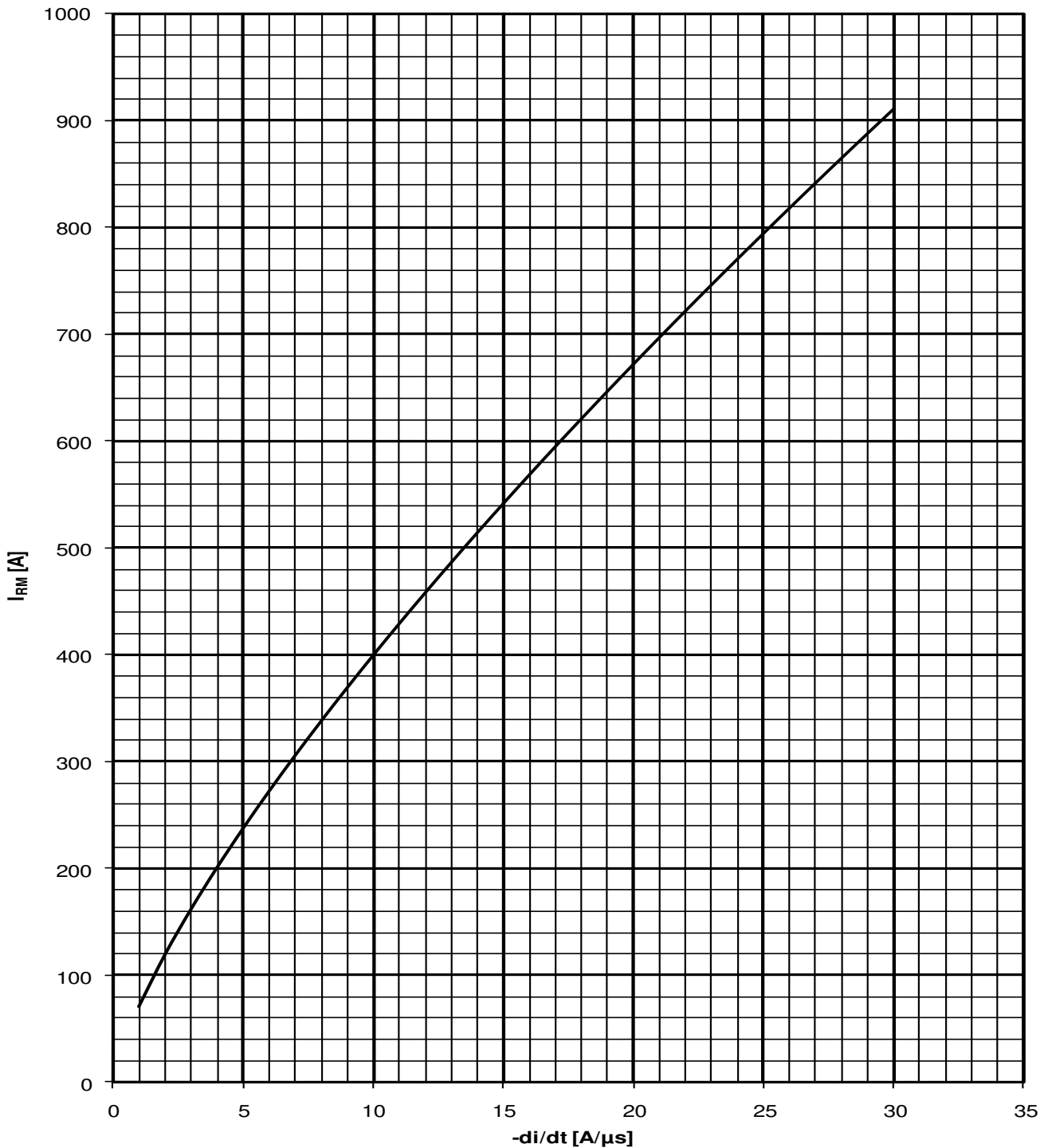
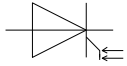

Rückstromspitze / peak reverse recovery current $I_{RM} = f(-di/dt)$

$$T_{vj} = T_{vjmax}, V_R = 0,5 V_{RRM}, V_{RM} = 0,8 V_{RRM}$$

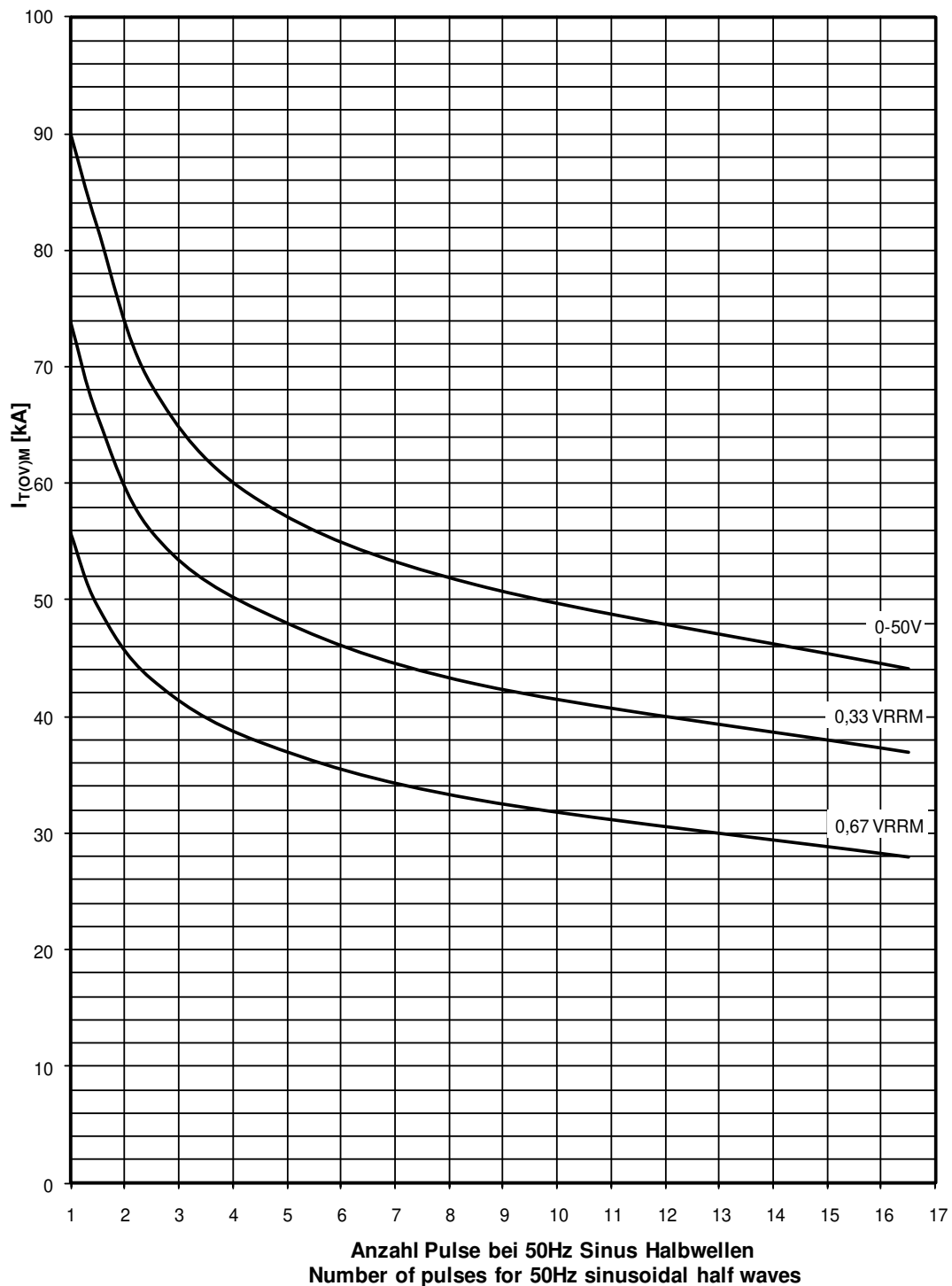
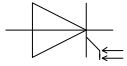

Typische Abhängigkeit des Grenzstromes $I_{T(OV)M}$ von der Anzahl für eine Folge von Sinus Halbwellen bei 50Hz.

Parameter: Rückwärtsspannung V_{RM}

Typical dependency of maximum overload on-state current $I_{T(OV)M}$ as a number of a sequence of sinusoidal half waves at 50Hz. Parameter: peak reverse voltage V_{RM}

$$I_{T(OV)M} = f(\text{pulses}, V_{RM}) ; T_{vj} = T_{vjmax}$$

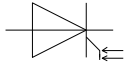

Nutzungsbedingungen

Die in diesem Produktdatenblatt enthaltenen Daten sind ausschließlich für technisch geschultes Fachpersonal bestimmt. Die Beurteilung der Geeignetheit dieses Produktes für die von Ihnen anvisierte Anwendung sowie die Beurteilung der Vollständigkeit der bereitgestellten Produktdaten für diese Anwendung obliegt Ihnen bzw. Ihren technischen Abteilungen.

In diesem Produktdatenblatt werden diejenigen Merkmale beschrieben, für die wir eine liefervertragliche Gewährleistung übernehmen. Eine solche Gewährleistung richtet sich ausschließlich nach Maßgabe der im jeweiligen Liefervertrag enthaltenen Bestimmungen. Garantien jeglicher Art werden für das Produkt und dessen Eigenschaften keinesfalls übernommen.

Sollten Sie von uns Produktinformationen benötigen, die über den Inhalt dieses Produktdatenblatts hinausgehen und insbesondere eine spezifische Verwendung und den Einsatz dieses Produktes betreffen, setzen Sie sich bitte mit dem für Sie zuständigen Vertriebsbüro in Verbindung (siehe www.infineon.com). Für Interessenten halten wir Application Notes bereit.

Aufgrund der technischen Anforderungen könnte unser Produkt gesundheitsgefährdende Substanzen enthalten. Bei Rückfragen zu den in diesem Produkt jeweils enthaltenen Substanzen setzen Sie sich bitte ebenfalls mit dem für Sie zuständigen Vertriebsbüro in Verbindung.

Sollten Sie beabsichtigen, das Produkt in Anwendungen der Luftfahrt, in gesundheits- oder lebensgefährdenden oder lebenserhaltenden Anwendungsbereichen einzusetzen, bitten wir um Mitteilung. Wir weisen darauf hin, dass wir für diese Fälle

- die gemeinsame Durchführung eines Risiko- und Qualitätsassessments;
- den Abschluss von speziellen Qualitätssicherungsvereinbarungen;
- die gemeinsame Einführung von Maßnahmen zu einer laufenden Produktbeobachtung dringend empfehlen und gegebenenfalls die Belieferung von der Umsetzung solcher Maßnahmen abhängig machen.

Soweit erforderlich, bitten wir Sie, entsprechende Hinweise an Ihre Kunden zu geben.

Inhaltliche Änderungen dieses Produktdatenblatts bleiben vorbehalten.

Terms & Conditions of usage

The data contained in this product data sheet is exclusively intended for technically trained staff. You and your technical departments will have to evaluate the suitability of the product for the intended application and the completeness of the product data with respect to such application.

This product data sheet is describing the characteristics of this product for which a warranty is granted. Any such warranty is granted exclusively pursuant the terms and conditions of the supply agreement. There will be no guarantee of any kind for the product and its characteristics.

Should you require product information in excess of the data given in this product data sheet or which concerns the specific application of our product, please contact the sales office, which is responsible for you (see www.infineon.com). For those that are specifically interested we may provide application notes.

Due to technical requirements our product may contain dangerous substances. For information on the types in question please contact the sales office, which is responsible for you.

Should you intend to use the Product in aviation applications, in health or life endangering or life support applications, please notify. Please note, that for any such applications we urgently recommend

- to perform joint Risk and Quality Assessments;
- the conclusion of Quality Agreements;
- to establish joint measures of an ongoing product survey, and that we may make delivery depended on the realization of any such measures.

If and to the extent necessary, please forward equivalent notices to your customers.

Changes of this product data sheet are reserved.