



Chipsmall Limited consists of a professional team with an average of over 10 year of expertise in the distribution of electronic components. Based in Hongkong, we have already established firm and mutual-benefit business relationships with customers from,Europe,America and south Asia,supplying obsolete and hard-to-find components to meet their specific needs.

With the principle of “Quality Parts,Customers Priority,Honest Operation,and Considerate Service”,our business mainly focus on the distribution of electronic components. Line cards we deal with include Microchip,ALPS,ROHM,Xilinx,Pulse,ON,Everlight and Freescale. Main products comprise IC,Modules,Potentiometer,IC Socket,Relay,Connector.Our parts cover such applications as commercial,industrial, and automotives areas.

We are looking forward to setting up business relationship with you and hope to provide you with the best service and solution. Let us make a better world for our industry!



Contact us

Tel: +86-755-8981 8866 Fax: +86-755-8427 6832

Email & Skype: info@chipsmall.com Web: www.chipsmall.com

Address: A1208, Overseas Decoration Building, #122 Zhenhua RD., Futian, Shenzhen, China





Inspired Wireless M2M Technology

Tango 45

Miniature Antenna

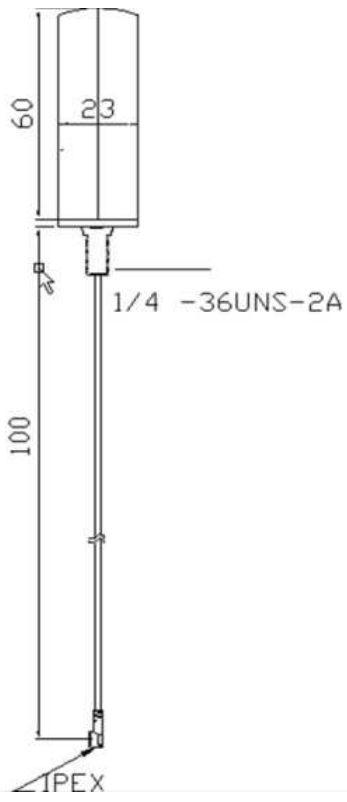

Key Specifications - Electrical

Operating temperature:	-30°C to +60°C
Input impedance:	50Ω ± 5Ω
Gain:	2/2/4dBi
VSWR:	≤3.5
Frequency:	734 - 960 / 1710 - 2170 / 2300-2700MHz
Max power:	1 Watt
Isolation:	N/A
Beamwidth:	H-Plane - 360° E-Plane - 50°
Polarization:	Vertical

Key Specifications - Mechanical

Dimensions:	Ø23 x 60mm ± 2mm
Weight:	14g ± 0.5g
Cable type:	RF1.13
Cable length:	10cm
Connector:	IPEX
Material radome:	ABS
RoHS compliant:	Yes

Test Reports

VSWR

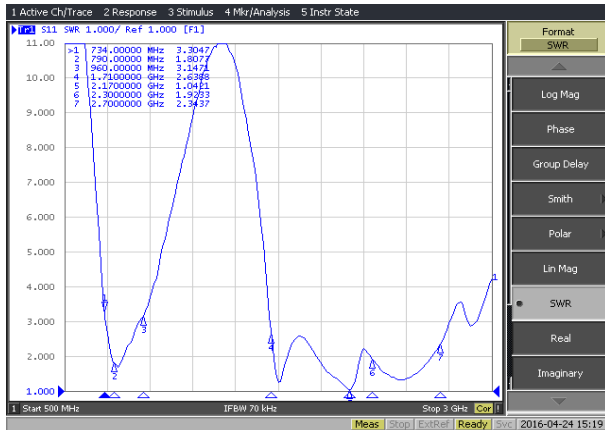

S11

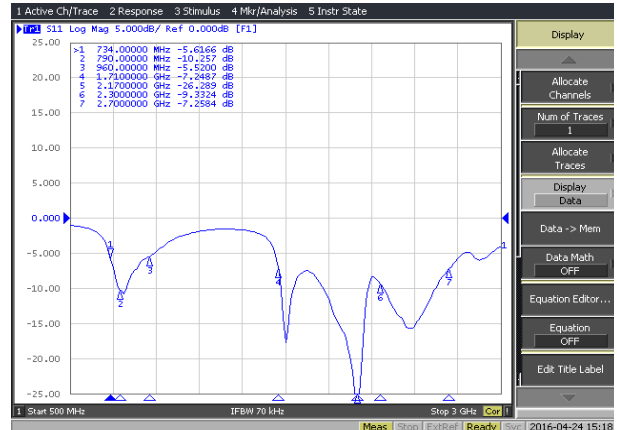

Radiation Pattern

H Plane - 734 - 960MHz

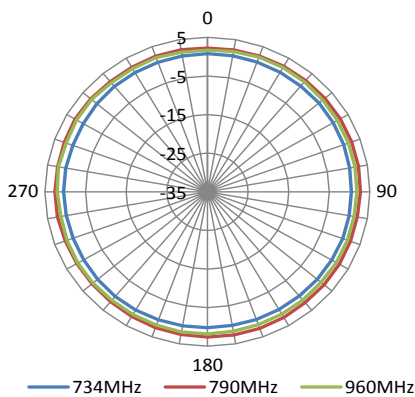

H Plane - 1710 - 2170MHz

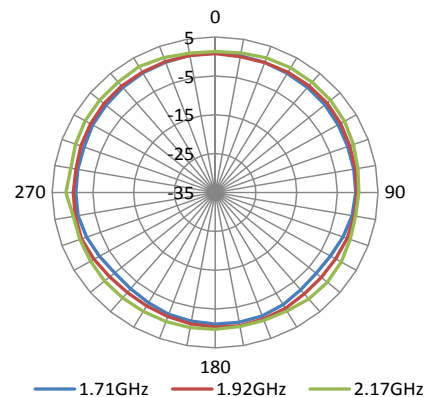

H Plane - 2300 - 2700MHz

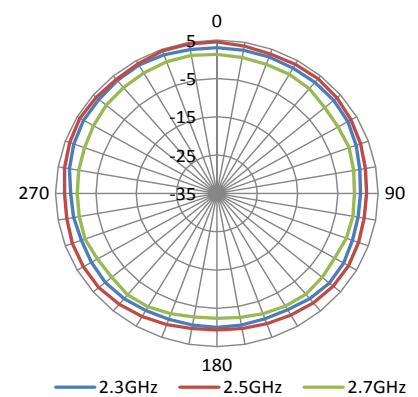

Radiation Pattern

E Plane - 734 - 960MHz

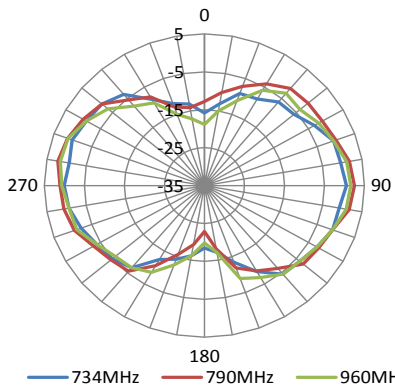

E Plane - 1710 - 2170MHz

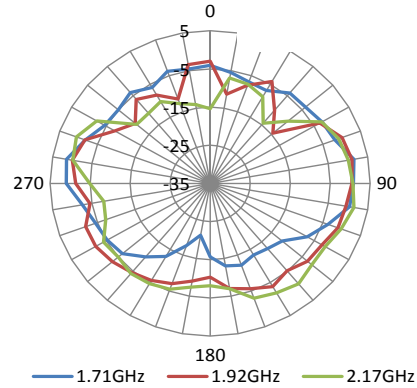

E Plane - 2300 - 2700MHz

