



Chipsmall Limited consists of a professional team with an average of over 10 year of expertise in the distribution of electronic components. Based in Hongkong, we have already established firm and mutual-benefit business relationships with customers from,Europe,America and south Asia,supplying obsolete and hard-to-find components to meet their specific needs.

With the principle of “Quality Parts,Customers Priority,Honest Operation,and Considerate Service”,our business mainly focus on the distribution of electronic components. Line cards we deal with include Microchip,ALPS,ROHM,Xilinx,Pulse,ON,Everlight and Freescale. Main products comprise IC,Modules,Potentiometer,IC Socket,Relay,Connector.Our parts cover such applications as commercial,industrial, and automotives areas.

We are looking forward to setting up business relationship with you and hope to provide you with the best service and solution. Let us make a better world for our industry!



Contact us

Tel: +86-755-8981 8866 Fax: +86-755-8427 6832

Email & Skype: info@chipsmall.com Web: www.chipsmall.com

Address: A1208, Overseas Decoration Building, #122 Zhenhua RD., Futian, Shenzhen, China





Viper

LS6 Thermal Transfer Portable Printer





Features

- Crisp 203 dpi thermal transfer print for professional looking labels with no smearing
 - Automatically recognizes label size and adjusts printer settings to eliminate wasted setup time
 - Tracks number of labels remaining on the roll and warns operator if there are not enough labels on the roll to finish a print job
 - Nickel Metal Hydride battery provides longer battery life, is less susceptible to memory effect, and is more environmentally friendly
 - AC Adapter included so you can start printing right out of the box
- Internal overnight battery charger built into printer
 - Fast loading ribbon cartridge lets you slide, lock and go! — No difficult ribbon threading
 - 128K file memory reduces setup time by recalling frequently used labels
 - Large, ergonomic input keys are easy to find and manipulate
 - Rugged mechanical cutter — no need for scissors
 - Annunciator sounds after each key stroke to improve data entry speed and accuracy
 - Bi-directional feeding automatically feeds label forward for cutting and automatically reverse feeds to eliminate wasted label stock
 - Handy calculator function included
 - PCMCIA Card factory upgradeable

Label Design Flexibility

- 3.0" x 1.5" graphic screen display enables visual label design
- Print preview — eliminates guessing what your labels will look like
- Tools based firmware allows up to 8 different objects on a single label
- Choose from the following tools:
 - Text
 - Alpha and numeric serialization
 - Bar codes
 - Symbols
 - Date and time stamp
 - Line
 - Box
- Online help available on all screens

LARGE GRAPHIC SCREEN

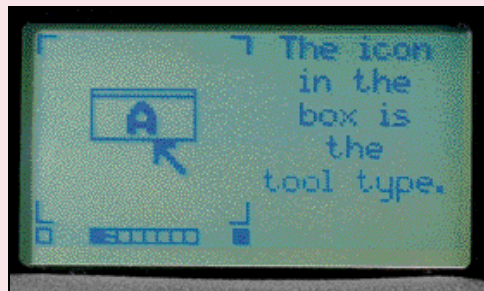
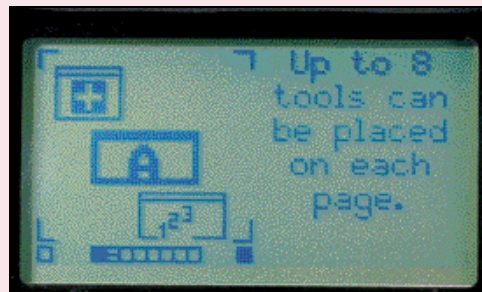
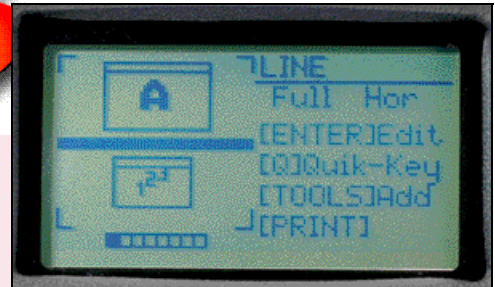

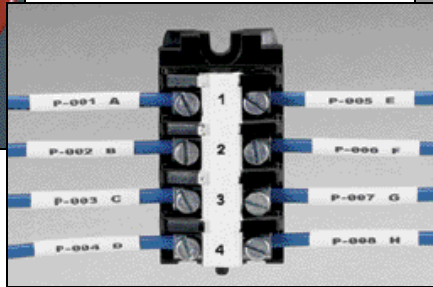
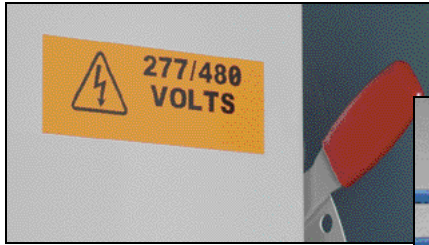

One Printer For All Your Labeling Needs

- Create wire markers, heat shrink labels, continuous tape, component labels, bin markers, pipe markers, safety/facility identification and network connectivity labels
 - Labels are available in a variety of materials in widths from 0.25" to 2.00"
 - Alpha and numeric serialization
 - Bar code printing
 - Date and time stamp
 - Print text from 6 pt to 192 pt tall
 - Large symbol library contains over 35 electrical, safety and network symbols
- Examples:

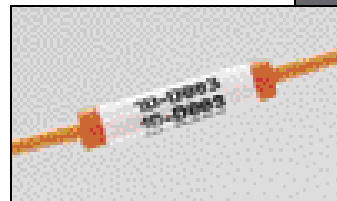
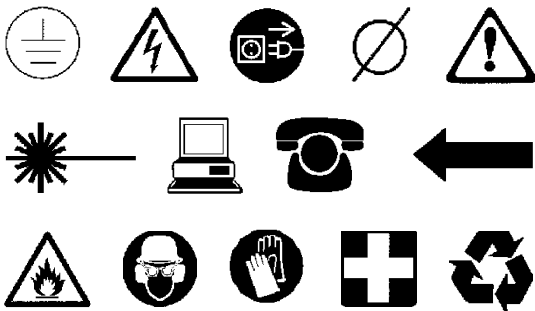
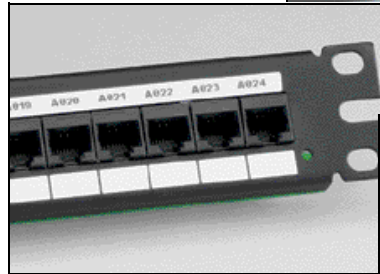

Computer Connectivity

- RS232 Port
- **VIPERLINK**™ Software
 - Upgrade the operating system
 - Download files
 - Upload files
 - Create legend lists



Printer Mechanical Information

Print Method: 203 dpi thermal transfer print head

Size: Height: 6.2" (157 mm)
 Width: 4.9" (124 mm)
 Length: 13.8" (351 mm)
 Weight: 4.1 lbs. (1.9 kg)

Display: 3.0" wide x 1.5" tall (76 x 38 mm) graphics screen display

Keyboard: 49 color coded keys with ergonomically designed keypad

Power Source: 12VDC, 1200mAh rechargeable NiMH (Nickel Metal Hydride) Battery Pack (included) or AC Adapter (included)

Printer and Accessories

Part Number	Description	Std. Pkg. Qty.*	Std. Ctn. Qty.
LS6-KIT	Includes Printer, LS6-RWBLK Ribbon, Battery Pack, 120 VAC Adapter/Charger, Hardside Case and Operator's Manual	1	—
LS6-RWBLK	Wax Ribbon, Black, 2" x 100' For use with self-laminating, heat shrink and vinyl cloth materials	1	6
LS6-RRBLK	Resin Ribbon, Black 2" x 100' For use with polyester, polyolefin and vinyl materials	1	6
LS6-RRWHT	Resin Ribbon, White, 2" x 100' For use with clear polyester tape	1	6
LS6-BP	Replacement Battery Pack	1	—
LS6-ACS	Replacement 120 VAC Adapter/Charger	1	—
LS6-ACE	Optional Euro 230 VAC Adapter/Charger	1	—
LS6-ACU	Optional U.K. 240 VAC Adapter/Charger	1	—
LS6-ACA	Optional Australia 240 VAC Adapter/Charger	1	—
LS6-PCKIT	PC Interface Kit Serial Cable and VIPERLINK™ Software	1	—
LS6-CLN	Package of 5 Printer Cleaning Cards	1	5



*Order number of accessories required in multiples of Std. Pkg. Qty.

LABELCORE™ Fiber Optic Cable Identification System

- Allows user to slide or rotate label for easy viewing without damaging cable

Part Number	Description	Std. Pkg. Qty.*	Std. Ctn. Qty.
LABELCORE Sleeve			
NWSLC-2	Yellow sleeve for 2mm fiber optic cable	100	1000
NWSLC-3	Orange sleeve for 3mm fiber optic cable		
Self-Laminating Label			
TWS-15V	Self-laminating vinyl label for use with NWSLC-2 and NWSLC-3 1.00" Width x 1.60" Height x 0.80" Print-On Height (25.4 x 40.6 x 20.3 mm), 250 labels/roll	1 Roll	10 Rolls

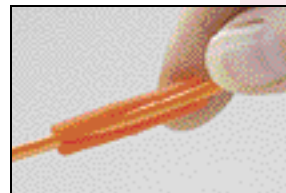

Apply LABELCORE Sleeve to cable



Wrap self-laminating label around LABELCORE Sleeve

*Order number of cores or rolls required in multiples of Std. Pkg. Qty.

Self-Laminating Labels for Wire and Cable

- Vinyl material with white print-on area
- Clear overlamine protects legend
- Print with LS6-RWBLK wax ribbon

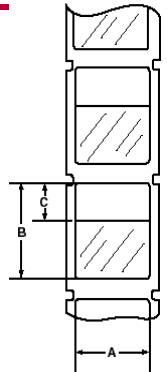

Part Number	Label Width x Height A x B In. (mm)	Print-On Height C In. (mm)	Nominal Cable Diameter Range In. (mm)	Typical UTP Cable	Typical Fiber Optic Cable	Typical Electrical (THHN)	Labels/ Roll	Std. Pkg. Qty.*	Std. Ctn. Qty.
TWS-6V	0.50 x 0.75 (12.7 x 19.1)	0.38 (9.5)	0.12 (3.1)	—	—	12 AWG	500	1 Roll	10 Rolls
TWS-7V	1.00 x 0.75 (25.4 x 19.1)	0.38 (9.5)	0.12 (3.1)	—	—	12 AWG	250		
TWS-4V	0.50 x 1.00 (12.7 x 25.4)	0.38 (9.5)	0.12 - 0.20 (3.1 - 5.0)	—	2-4 Strand	12-10 AWG	400		
TWS-5V	1.00 x 1.00 (25.4 x 25.4)	0.38 (9.5)	0.12 - 0.20 (3.1 - 5.0)	—	2-4 Strand	12-10 AWG	250		
TWS-1V	0.50 x 1.25 (12.7 x 31.8)	0.50 (12.7)	0.16 - 0.24 (4.0 - 6.1)	4 Pair	2-8 Strand	8 AWG	350		
TWS-2V	1.00 x 1.25 (25.4 x 31.8)	0.50 (12.7)	0.16 - 0.24 (4.0 - 6.1)	4 Pair	2-8 Strand	8 AWG	250		
TWS-3V	1.50 x 1.25 (38.1 x 31.8)	0.50 (12.7)	0.16 - 0.24 (4.0 - 6.1)	4 Pair	2-8 Strand	8 AWG	250		
TWS-40V	2.00 x 1.50 (50.8 x 38.1)	0.50 (12.7)	0.16 - 0.32 (4.0 - 8.1)	4 Pair	2-18 Strand	8-6 AWG	250		
TWS-10V	1.00 x 2.50 (25.4 x 63.5)	0.75 (19.1)	0.24 - 0.56 (6.1 - 14.2)	25 Pair	8-84 Strand	6 AWG-2/0	100		
TWS-11V	1.50 x 2.50 (38.1 x 63.5)	0.75 (19.1)	0.24 - 0.56 (6.1 - 14.2)	25 Pair	8-84 Strand	6 AWG-2/0	100		
TWS-13V	1.50 x 4.00 (38.1 x 101.6)	1.00 (25.4)	0.32 - 0.96 (8.1 - 24.3)	25 Pair	42-156 Strand	4 AWG-500 MCM	100		

* Order number of rolls required in multiples of Std. Pkg. Qty.

Heat Shrink Labels for Wire and Cable

- Flattened Polyolefin Material
- Service Temperature Range: -22°F to 220°F (-30°C to 105°C)
- Shrink Ratio 3:1 @ 212°F (100°C)
- Flammability meets UL Standard 224 for flammability
- Color: White
- Print with LS6-RWBLK wax ribbon

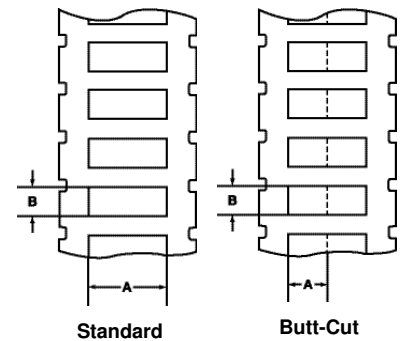

Part Number	Tubing O.D. In. (mm)	Width x Height A x B In. (mm)	Nominal Cable Diameter Range In. (mm)	Typical UTP Cable	Typical Fiber Optic Cable	Typical Electrical (THHN)	Labels/ Roll	Std. Pkg. Qty.*	Std. Ctn. Qty.
THSW-1•	0.13 (3.2)	0.50 x 0.25 (12.7 x 6.4)	0.04 - 0.13 (1.1 - 3.2)	—	—	18-12 AWG	200	1 Roll	10 Rolls
THSW-2	0.13 (3.2)	1.00 x 0.25 (25.4 x 6.4)	0.04 - 0.13 (1.1 - 3.2)	—	—	18-12 AWG	100		
THSW-6•	0.19 (4.8)	0.50 x 0.34 (12.7 x 8.5)	0.06 - 0.19 (1.6 - 4.8)	—	2 Strand	18-10 AWG	200		
THSW-7	0.19 (4.8)	1.00 x 0.34 (25.4 x 8.5)	0.06 - 0.19 (1.6 - 4.8)	—	2 Strand	18-10 AWG	100		
THSW-3•	0.25 (6.4)	0.50 x 0.44 (12.7 x 11.2)	0.08 - 0.25 (2.1 - 6.4)	4 Pair	2-8 Strand	18-8 AWG	200		
THSW-4	0.25 (6.4)	1.00 x 0.44 (25.4 x 11.2)	0.08 - 0.25 (2.1 - 6.4)	4 Pair	2-8 Strand	18-8 AWG	100		
THSW-5	0.50 (12.7)	1.00 x 0.84 (25.4 x 21.3)	0.17 - 0.50 (4.2 - 12.7)	4 Pair	4-60 Strand	8-1 AWG	100		

•Indicates butt-cut style label

*Order number of rolls required in multiples of Std. Pkg. Qty.

Wire and Cable Labels

- Wrap around or flag wiring for effective identification
- Vinyl cloth material
- Color: White
- Print with LS6-RWBLK wax ribbon

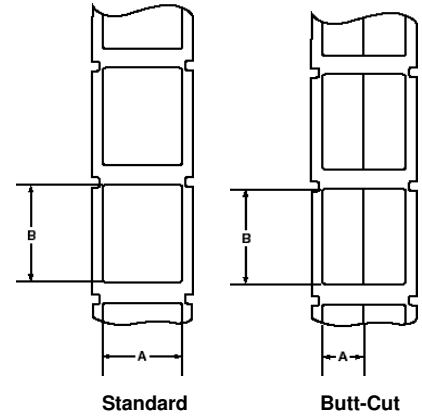
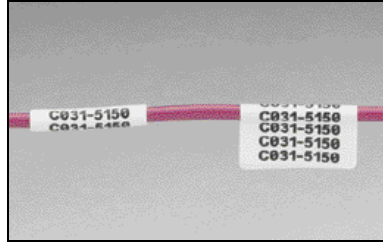

Part Number	Width x Height A x B In. (mm)	Labels/ Roll	Std. Pkg. Qty.*	Std. Ctn. Qty.
TW-4C	0.50 x 0.75 (12.7 x 19.1)	250	1 Roll	10 Rolls
TW-6C	0.50 x 0.75 (12.7 x 19.1)	500		
TW-2C	1.00 x 1.25 (25.4 x 31.8)	250		

*Indicates butt-cut style label
*Order number of rolls required in multiples of Std. Pkg. Qty.

Component Labels

- Property control, inventory tracking, product identification
- Available in polyester for permanent applications and vinyl cloth for temporary applications
- Color: White
- Print vinyl cloth labels with LS6-RWBLK wax ribbon
- Print polyester labels with LS6-RRBLK resin ribbon

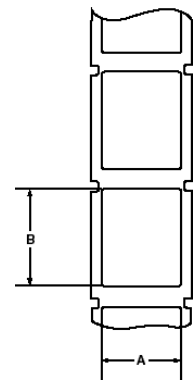

Part Number	Width x Height A x B In. (mm)	Material	Labels/ Roll	Std. Pkg. Qty.*	Std. Ctn. Qty.
TC-19Y	0.65 x 0.20 (16.5 x 5.1)	Polyester	750	1 Roll	10 Rolls
TC-17Y	1.00 x 0.38 (25.4 x 9.5)	Polyester	500		
TC-10C	1.00 x 0.50 (25.4 x 12.7)	Vinyl Cloth	500		
TC-4C	1.00 x 0.75 (25.4 x 19.1)	Vinyl Cloth	250		
TC-11Y	1.50 x 0.50 (38.1 x 12.7)	Polyester	500		
TC-16Y	2.00 x 0.25 (50.8 x 6.4)	Polyester	250		

*Order number of rolls required in multiples of Std. Pkg. Qty.

Terminal Block Labels

- Polyolefin material
- Color: White
- Print with LS6-RRBLK resin ribbon

Part Number	Label Width A In. (mm)	Roll Length B Ft. (m)	Labels/ Roll	Std. Pkg. Qty.*	Std. Ctn. Qty.
TCT-13PO	0.24 (6.1)	30 (9.1)	1	1 Roll	10 Rolls
TCT-14PO	0.31 (7.9)	30 (9.1)			
TCT-15PO	0.38 (9.5)	30 (9.1)			

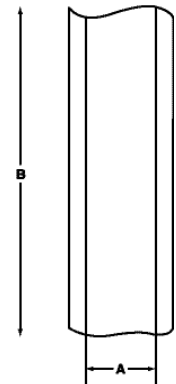
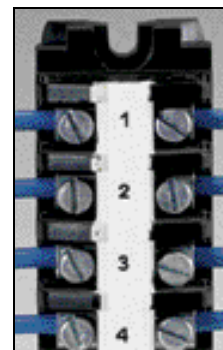

*Order number of rolls required in multiples of Std. Pkg. Qty.

Safety and Facility Identification - Continuous Tapes

- Bin marking, safety and facility identification, component labeling and pipe marking
- Print TCT-21YCL and TCT-2YCL with LS6-RRBLK or LS6-RRWHT resin ribbon. Print all other parts with LS6-RRBLK resin ribbon.

Part Number	Tape Width In. (mm)	Tape Length Ft. (m)	Color	Material	Std. Pkg. Qty.*	Std. Ctn. Qty.
TCT-20Y	0.25 (6.4)	50 (15.2)	White	Polyester	1 Roll	10 Rolls
TCT-21YCL	0.25 (6.4)	50 (15.2)	Clear	Polyester		
TCT-2YCL	1.00 (25.4)	50 (15.2)	Clear	Polyester		
TCT-1V	1.00 (25.4)	50 (15.2)	White	Vinyl		
TCT-3V	1.00 (25.4)	50 (15.2)	Yellow	Vinyl		
TCT-6V	1.00 (25.4)	50 (15.2)	Orange	Vinyl		
TCT-8V	2.00 (50.8)	50 (15.2)	White	Vinyl		
TCT-9V	2.00 (50.8)	50 (15.2)	Yellow	Vinyl		
TCT-10V	2.00 (50.8)	50 (15.2)	Orange	Vinyl		

*Order number of rolls required in multiples of Std. Pkg. Qty.

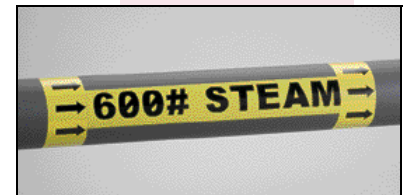

Network System Component Labels

- Identify faceplates, surface mount boxes, modular jacks and patch panels
- Print TNS-15YCL and TCT-21YCL with LS6-RRBLK or LS6-RRWHT resin ribbons. Print all other parts with LS6-RRBLK resin ribbon.

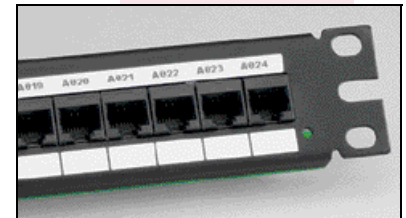
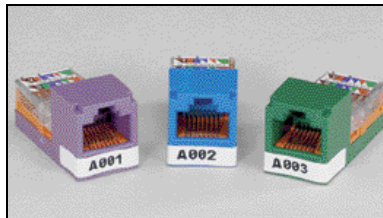

Part Number	Application	Width x Height In. (mm)	Can Be Used With The Following PANDUIT Part Numbers	Color	Material	Labels/ Roll	Std. Pkg. Qty.*	Std. Ctn. Qty.
TNS-1NY	Single gang faceplates; Junction boxes	1.95 x 0.40 (49.5 x 10.2)	All CFPL, All CFPSL, CFPE1, CFPE2, CFPE4, CFPE6, CBX4, CBXS4, CBXD6, CBX12, CBXF6, CBXF12, CBXS6, CBE	White	Non-Adhesive Polyester	500	1 Roll	10 Rolls
TNS-2NY	Double gang faceplates	2.88 x 0.40 (73.2 x 10.2)	CBE-2G and CFPE10-2G	White	Non-Adhesive Polyester	150		
TNS-3NY	24 and 48 port modular patch panels with connector groups of 4; 4 position modular furniture faceplates	2.61 x 0.35 (66.2 x 8.8)	CFFPL4, CFPHSL4, CPPL24WBL, CPPL48WBL	White	Non-Adhesive Polyester	150		
TNS-4NY	24 and 48 port modular patch panels with connector groups of 6	3.90 x 0.30 (99.1 x 7.6)	CPPL24M6, CPPL48M6 and CUFMB24BL	White	Non-Adhesive Polyester	150		
TNS-5NY	72 port modular patch panels	2.82 x 0.30 (71.6 x 7.6)	CFFPL72W	White	Non-Adhesive Polyester	150		
TNS-15Y	Adhesive label for modular jacks	1.38 x 0.19 (34.9 x 4.8)	All FJJ Modules, All Category 3,5,5e and 6 Modules	White	Adhesive Polyester	500		
TNS-15YCL				Clear				
TCT-20Y	Continuous adhesive tape for faceplates, patch panels, boxes, etc.	50 ft. x 0.25 (15.2m x 6.4)	All Faceplates, Patch Panels and Boxes	White	Adhesive Polyester	50 ft./roll		
TCT-21YCL				Clear				

*Order number of rolls required in multiples of Std. Pkg. Qty.

Material Selection

Material Type	Temperature Range	Description	Key Feature	Color	Outdoor Rated	UL Rec.*
Self-Laminating Adhesive Vinyl	-40° to 150°F (-40° to 66°C)	Self-laminating film for most general wire and cable labeling	Low cost, conformable material	Clear	No	Yes
White Adhesive Vinyl Cloth	-50° to 170°F (-46° to 77°C)	General purpose material, vinyl impregnated cloth resists oil and abrasion	Material can be removed and reused	White	No	No
Clear Adhesive Polyester	-40°F to 257°F (-40°C to 125°C)	General purpose material for component labeling, excellent print quality	Durable; high temperature; does not stretch or easily tear	Clear	Yes	Yes
White Adhesive Polyester	-40°F to 302°F (-40°C to 150°C)			White	Yes	Yes
White Non-Adhesive Polyester	-40°F to 375°F (-40°C to 190°C)	Non-adhesive material ideal for network systems labeling	Non-adhesive	White	Yes	No
White Heat Shrink Polyolefin	-22° to 220°F (-30° to 105°C)	Polyolefin heat shrink for wire marking applications, excellent print quality	Secure identification	White	Yes	No
White Adhesive Vinyl	-65° to 176°F (-54° to 80°C)	General purpose material for pipe marking, bin marking and facility identification	Conformable material for flat applications in indoor or outdoor environments	White	Yes, 2 Years	Yes
Orange and Yellow Adhesive Vinyl	-65° to 176°F (-54° to 80°C)			Orange, Yellow	Yes, 2 Years	No
White Adhesive Polyolefin	-50° to 120°F (-46° to 49°C)	General purpose material for terminal block labels	Conformable material for flat applications in indoor environments	White	No	No

* Recognized materials (UL 969 Marking and Labeling Systems)

Also Available

PAN-QUIK™ LS3E Hand-Held Dot-Matrix Printer



- 20K File Storage Memory saves time when producing frequently used labels
- Flexibility to print self-laminating labels, heat shrink labels, component labels, asset identification labels and more
- Fast drying self-laminating labels reduce installation time
- Automatic recall of last legend entered
- Easy formatting options reduce setup time
- Automatic serialization and legend repeat functions
- Quick change battery pack and optional AC adapter for reduced downtime
- Exact label registration

Our products are warranted to be free from defects in material and workmanship at the time of sale but our obligation under this warranty is limited to the replacement of any product proved to be defective within 6 months (for product) or 90 days (for tools) from the date of delivery. Tool warranty is void if Panduit tools are modified, altered or misused in any way. Use of Panduit tooling with any product other than the specified Panduit products for which the tool was designed,

constitutes misuse. Before using, user shall determine the suitability of the product for his intended use and user assumes all risk and liability whatsoever in connection therewith.

This warranty is made in lieu of and excludes all other warranties, expressed or implied. THE IMPLIED WARRANTIES OF MERCHANTABILITY AND FITNESS FOR A PARTICULAR USE ARE SPECIFICALLY EXCLUDED. Neither seller nor manufacturer shall be liable for any other injury, loss or damage, whether direct or consequential, arising out of the use of, or the inability to use, the product.

The information contained in this literature is based on our experience to date and is believed to be reliable. It is intended as a guide for use by persons having technical skill at their own discretion and risk. We do not guarantee favorable results or assume any liability in connection with its use. Dimensions contained herein are for reference purposes only. For specific dimensional requirements consult the factory. This publication is not to be taken as a license to operate under, or a recommendation to infringe any existing patents. This supersedes and voids all previous literature, etc.



PANDUIT Corp.
Tinley Park, IL 60477-3091

PANDUIT Canada
140 Amber Street
Markham, Ontario L3R 3J8

For Customer Service, contact
Phone: 800-777-3300
Fax: 708-532-1811

For Technical Support, contact
Labels and Safety: 866-405-6658
Software and Printers: 866-871-4571

email: id-support@panduit.com website: www.panduit.com/eg/ls6

WORLDWIDE SUBSIDIARIES AND SALES OFFICES

**For Pricing and Further Information –
Contact your local
PANDUIT Distributor or Sales Office**

SA-ID07BR01A

Printed in U.S.A.