



Chipsmall Limited consists of a professional team with an average of over 10 year of expertise in the distribution of electronic components. Based in Hongkong, we have already established firm and mutual-benefit business relationships with customers from,Europe,America and south Asia,supplying obsolete and hard-to-find components to meet their specific needs.

With the principle of “Quality Parts,Customers Priority,Honest Operation,and Considerate Service”,our business mainly focus on the distribution of electronic components. Line cards we deal with include Microchip,ALPS,ROHM,Xilinx,Pulse,ON,Everlight and Freescale. Main products comprise IC,Modules,Potentiometer,IC Socket,Relay,Connector.Our parts cover such applications as commercial,industrial, and automotives areas.

We are looking forward to setting up business relationship with you and hope to provide you with the best service and solution. Let us make a better world for our industry!



Contact us

Tel: +86-755-8981 8866 Fax: +86-755-8427 6832

Email & Skype: info@chipsmall.com Web: www.chipsmall.com

Address: A1208, Overseas Decoration Building, #122 Zhenhua RD., Futian, Shenzhen, China





Highly integrated and performance optimized
32-bit microcontrollers for automotive and industrial applications

Contents

TriCore™ family concept	3
Evolution of TriCore™ generations	4
TriCore™ based product roadmap	5
PRO-SIL™ safety concept	6
AURIX™ family system architecture	7
Embedded software (AUTOSAR etc.)	15
Development support	17
AURIX™ for powertrain applications	20
AURIX™ for safety applications	30
AURIX™ for connectivity applications	40
AURIX™ for transportation applications	44
AURIX™ for industrial applications	46
Tool partners	51



Family highlights

- > Compatibility and scalability
- > Lowest system cost
- > Industry benchmark system performance
- > Easy to use
- > Broad portfolio
- > Certified to automotive standards

Powertrain



Applications

- > Gasoline direct injection
- > Gasoline multi-port Injection
- > Diesel direct injection
- > Automatic transmission – hydraulic control
- > Dry double clutch transmission – hydraulic control
- > Dry double clutch transmission – electrical control
- > Integrated (H)EV control
- > (H)EV battery management system

Safety



Applications

- > Chassis domain control
- > Electric Power Steering (EPS)
- > Active suspension control system
- > Advanced airbag system
- > Braking ECU
- > Multi-purpose camera configuration
- > Short-range radar (24 GHz) system
- > Long-range radar (76/77 GHz) system

Connectivity



Applications

- > Body domain controller
- > Connected gateway
- > Advanced body applications
- > Telematics including software update over the air
- > V2x communication
- > eHorizon

Transportation



Applications

- > Commercial and Agricultural Vehicle (CAV)
- > Fun vehicle
- > Transportation
- > Trucks

Industrial & Multimarket



Applications

- > Mobile controller
- > Inverter
- > Wind turbine inverter
- > Solar panel



Evolution of TriCore™ generations

In 1999, Infineon launched the first generation of the AUDO (AUtomotive unifiedD processOr) family. Based on a unified RISC/MCU/DSP processor core, this 32-bit TriCore™ micro-controller was a computational power horse. And the company has evolved and optimized the concept ever since – culminating in what is now the fifth TriCore™ generation.

The TriCore™ success story continues with the introduction of the AURIX™ multicore family. AURIX™ combines easy-to-use functional safety support, a strong increase in performance and a future-proven security solution in a highly scalable product family.



With its high real-time performance, embedded safety and security features, the TriCore™ family is the ideal platform for a wide range of automotive applications such as the control of combustion engines, electrical and hybrid vehicles, transmission control units, chassis domains, braking systems, electric power steering systems, airbags and advanced driver assistance systems. TriCore™-based products also deliver the versatility required for the industrial sector, excelling in optimized motor control applications and signal processing. Infineon's broad product portfolio allows engineers to choose from a wide range of memories, peripheral sets, frequencies, temperatures and packaging options. And all this with a high degree of compatibility across generations.

The new AURIX™ family members are manufactured in a 65nm embedded Flash technology designed for ultimate reliability in harsh automotive environments. Furthermore, the dual frontend concept ensures continuous supply.

As was the case with previous generations, safety software is also available to help manufacturers meet SIL/ ASIL safety standards, as well as AUTOSAR libraries which Infineon has been developing since 2005.

TriCore™ based product roadmap

Segment	Production			Development	
	AUDO family		AURIX™ family	AURIX™ family	
	130 nm	90 nm	65 nm	65 nm	
High end	TC1797 180 MHz, 4 MB	TC1798 300 MHz, 4 MB	TC29x 300 MHz, 8 M		TC290 Bare die
		TC1793 270 MHz, 4 MB	TC27x 200 MHz, 4 M		
		TC1791 240 MHz, 4 MB			TC270 200 MHz, 4 M Bare die
Mid range	TC1768 133 MHz, 3 M Bare die	TC1746 180 MHz, 2.5 M Bare die			
		TC1784 180 MHz, 2.5 MB	TC26x 200 MHz, 2.5 M		
		TC1782 180 MHz, 2.5 MB			TC260 200 MHz, 2.5 M Bare die
	TC1767 80/133 MHz, 2 MB		TC23x 200 MHz, 2 M		
Low end		TC1728 133 MHz, 1.5 MB			
		TC1724 80 MHz, 1.5 MB			
	TC1736 80 MHz, 1 MB		TC22x 133 MHz, 1 M		
Companion ICs	CIC61508 Safety IC		TC21x 100 MHz, 0.5 M		

Production
 Development
 Concept / on request



Infineon's PRO-SIL™ program, designed to protect

The functional complexity and levels of integration of real-time safety-critical applications continue to increase exponentially. In addition, the product life cycle of these applications has to meet stringent safety standards. Norms such as IEC 61508 and ISO 26262 mandate more robust and comprehensive product development processes and functional safety concepts in automotive and industrial applications.

Infineon's PRO-SIL™ safety program is designed to ease and speed up your automotive and industrial design to comply with such standards. Across the full certification spectrum from Safety Integrity Levels (SIL) 1 to 4 and Automotive Safety Integrity Levels (ASIL) A to D, our end-to-end PRO-SIL™ approach will help you select the right hardware, software and functional safety concepts to meet your design and compliance needs.

PRO-SIL™ highlights

- › Broad hardware portfolio from sensors to microcontrollers, along with analog and power management ICs providing SIL-supporting features.
- › For ISO 26262 PRO-SIL™ products, safety concepts are in place to enable the required safety measures, testing, monitoring and diagnostics capabilities for your safety architecture.
- › Comprehensive safety software packages for seamless integration are in place, such as the SafeTlib software for Infineon's AURIX™ microcontroller family
- › Full range of support services – from consulting and design advice, including training, documentation and technical support – can be provided.
- › Safety-focused organization and project management based on Infineon's zero defect program, safety culture and quality management system are in place.

Infineon's PRO-SIL™ logo guides you to our products (HW, SW, safety documentation) with SIL-supporting features. These products will simplify the implementation of customers' system design and improve time-to-market in achieving the desired functional safety level compliance.

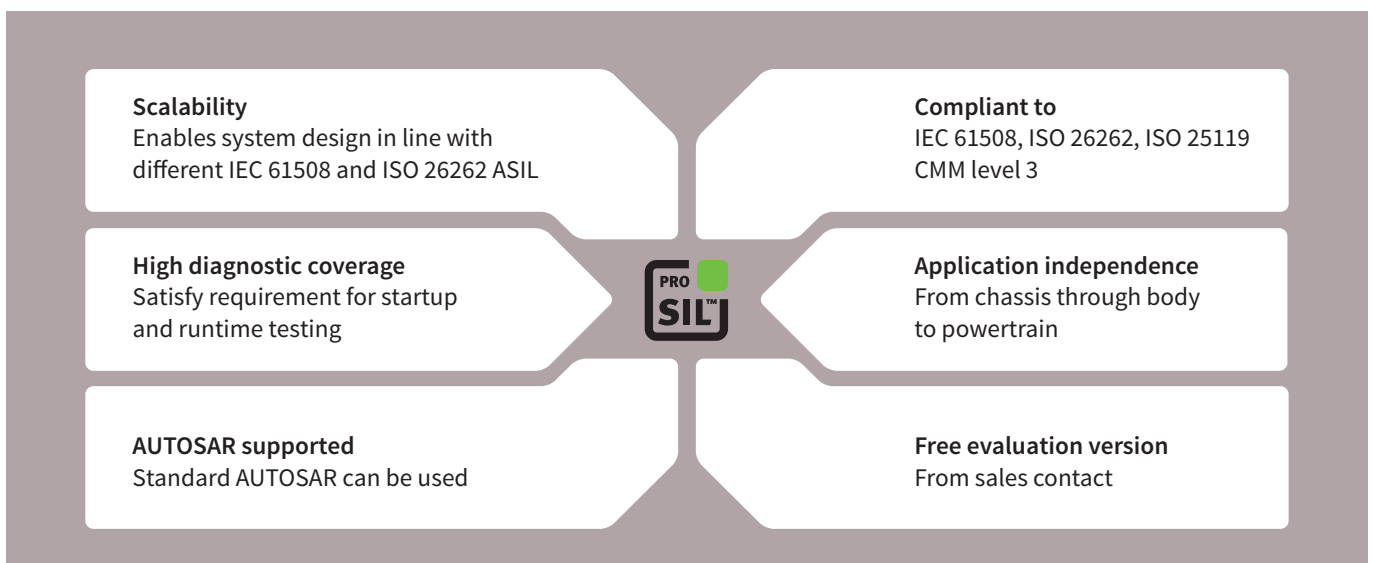

AURIX™ family system architecture

AURIX™ is Infineon's brand new family of microcontrollers serving exactly the needs of the automotive industry in terms of performance and safety. Its innovative multicore architecture, based on up to three independent 32-bit TriCore™ CPUs, has been designed to meet the highest safety standards while significantly increasing performance at the same time.

Using the AURIX™ platform, automotive developers will be able to control powertrain and safety applications with one single MCU platform. Developments using AURIX™ will require less effort to achieve the ASIL-D standard than with a classical lockstep architecture.

Customers wanting to reduce their time-to-market can now cut down their MCU safety development by 30%. By the same token, a performance surplus of 50% up to 100% allows for more functionality and offers a sufficient resource buffer for future requirements, keeping the power consumption on the single-core microcontroller level. While protecting IP, and preventing theft and fraud, AURIX™ provides an already built-in hardware security module.

With its special feature set, AURIX™ is the perfect match for powertrain applications (including hybrid and electrical vehicles) as well as safety applications (such as steering, braking, airbag and advanced driver assistance systems).

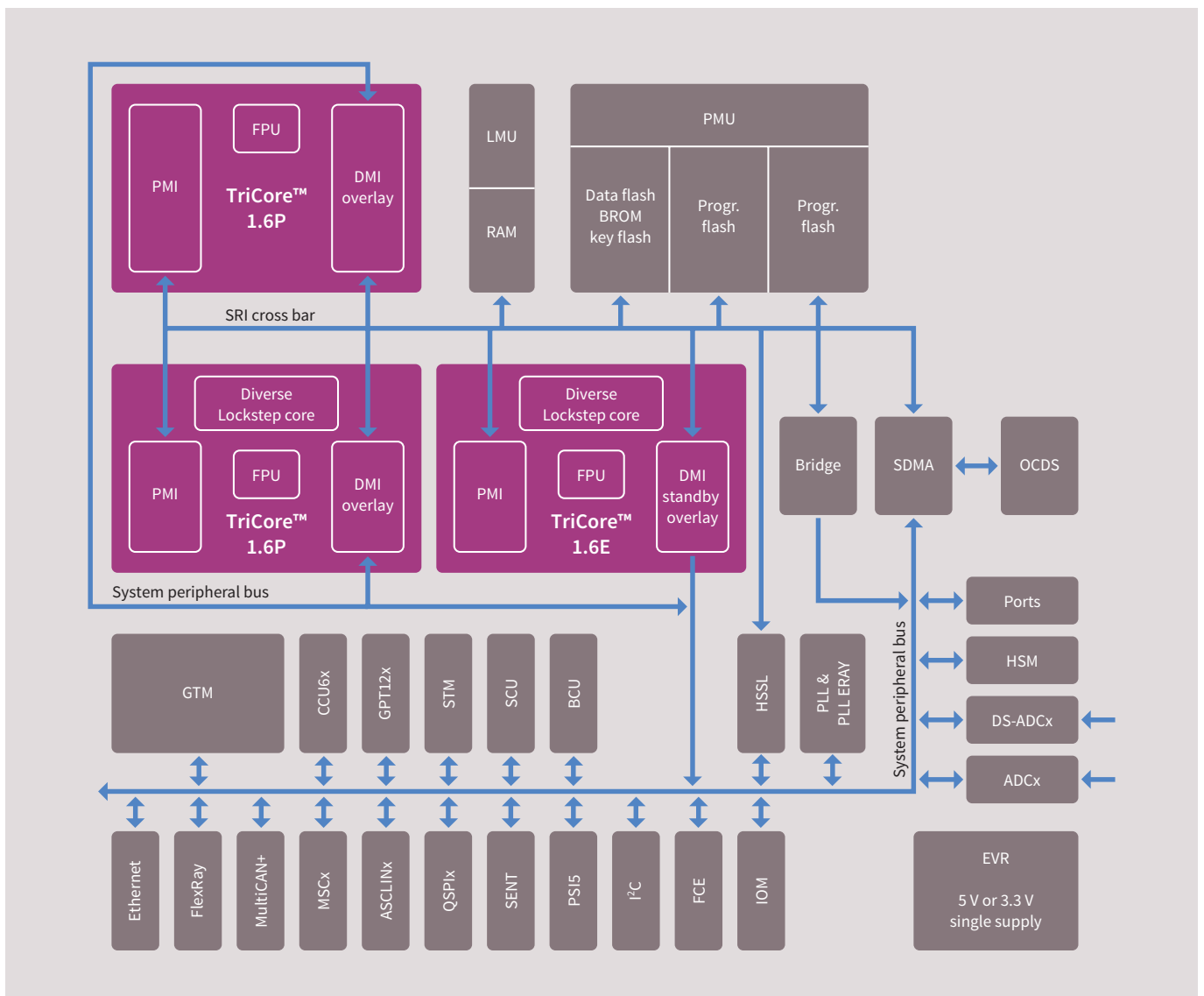

AURIX™ family package scalability

	TQFP-80	TQFP-100	LQFP-144 TQFP-144	LQFP-176	LFBGA-292	BGA-416	LFBGA-516
9x series up to 8 MB max. SRAM 2.75 MB triple-core					TC297	TC298	TC299
7x series up to 4 MB max. SRAM 472 KB triple-core				TC275	TC277		
6x series up to 2.5 MB max. SRAM 752 KB dual-core			TC264	TC265	TC267		
3x series up to 2 MB max. SRAM 708 KB Lockstep-core		TC233	TC234		TC237		
2x series up to 1 MB max. SRAM 96 KB Lockstep-core	TC222	TC223	TC224				
1x series up to 512 KB max. SRAM 56 KB Lockstep-core	TC212	TC213	TC214				

↕ Upgrade/downgrade with pin-compatible packages

- › Advanced package technologies deliver the best price/performance ratio
- › Customers can choose between different devices in the same pin-compatible package

TriCore™ upgrade paths

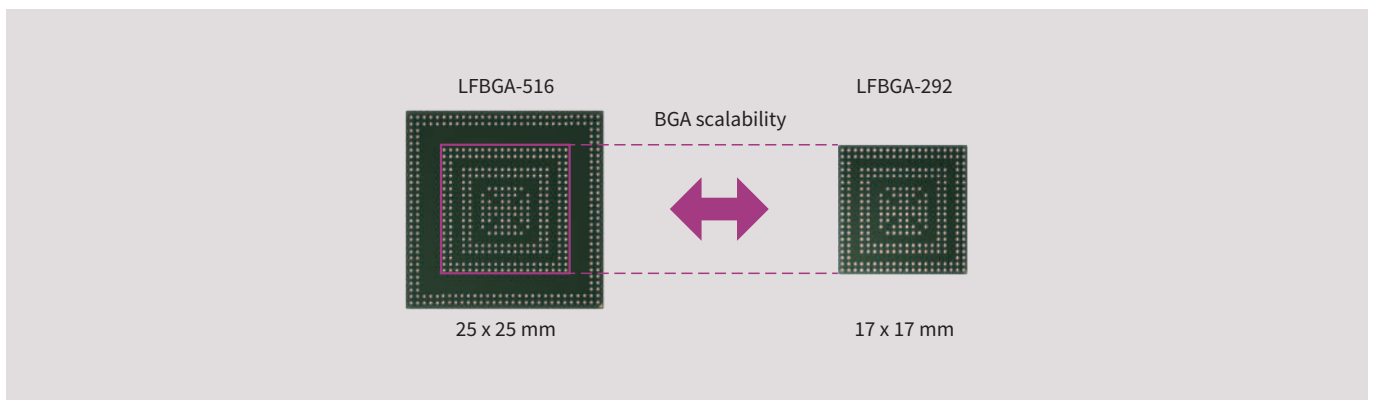

- › LFBGA-292 and LFBGA-516 are ball compatible so that customers can build one PCB for both packages

Package information¹⁾

LFBGA-516

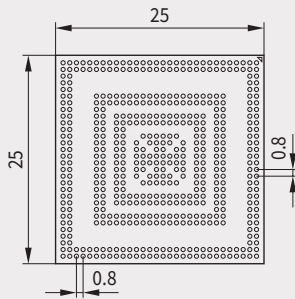

BGA-416

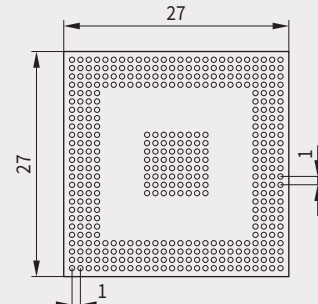

LFBGA-292

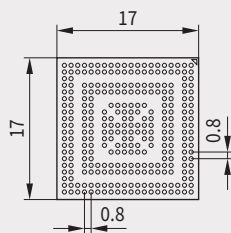

LQFP-176

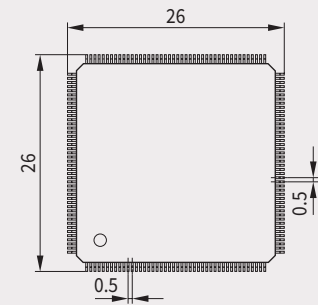

LQFP-144

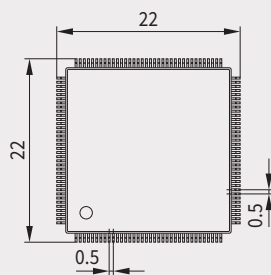

TQFP-144

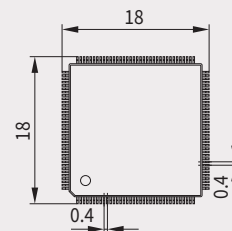

TQFP-100

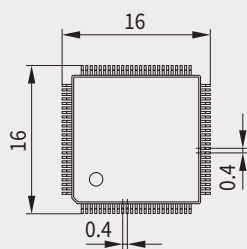

TQFP-80

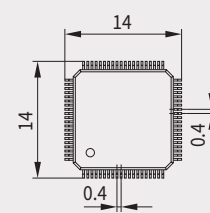

1) For further information on Infineon packages, please visit our internet site at www.infineon.com/packages

Infineon® diverse lockstep concept

- › Lockstep architecture designed to control and mitigate common cause factors
 - Physical isolation
 - Instruction-level execution diversity: 2-cycle delay
 - Circuit-level design & timing diversity
- › Layout-level diversity
- › Diversity controlled and verified by state-of-the-art design methods
- › Special design of clock & reset networks
- › Careful design of lockstep comparator
- › Main core and diverse lockstep core run the same software in parallel to detect computational errors
- › Like normal locksteps, both cores are physically separated and have a time delay between their execution
- › Diverse lockstep core has been additionally transformed to provide architectural hardware diversity and further reduce common cause failures

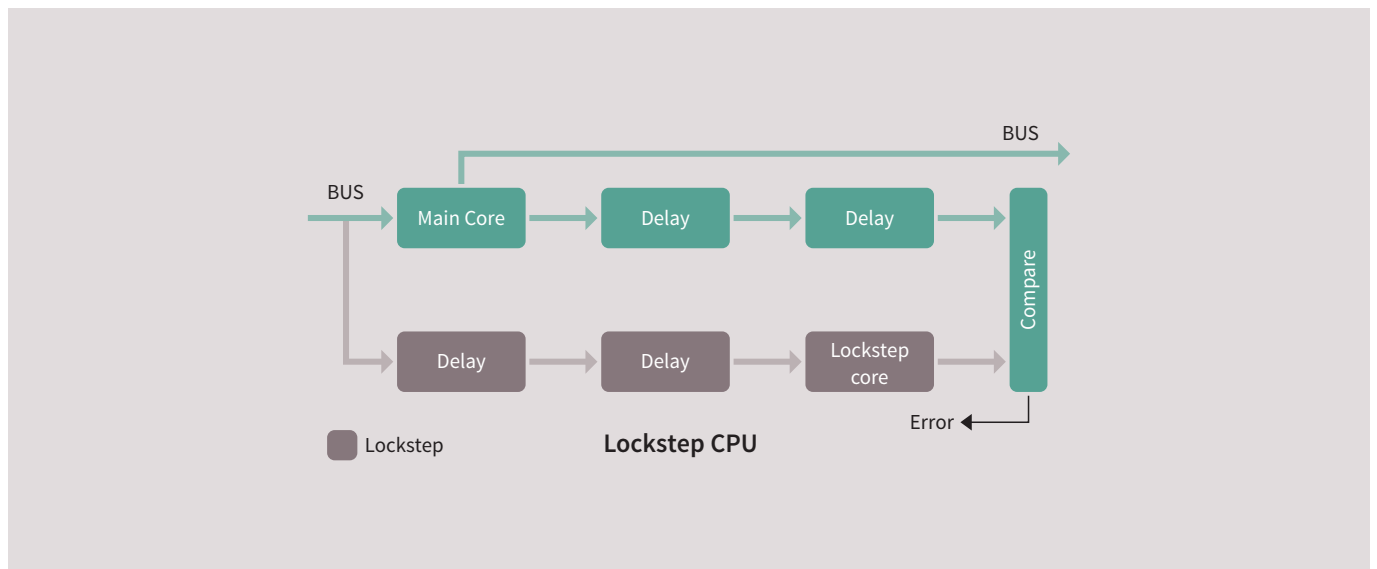

Multi-AUTOSAR OS support on one microcontroller

- > AURIX™ provides a memory protection system for each core plus an additional distributed hardware-based resource management system
- > Each peripheral and shared SRAM has a resource management unit that works as a local access protection mechanism to allow or deny access
- > When combined with the memory protection system, this hardware can be used to prevent selected direct access from certain tasks or cores to peripherals or regions of SRAMs and instead redirect the attempted access to a hypervisor function
- > The hypervisor can arbitrate/grant/deny access and therefore provide paravirtualization of mixed-criticality tasks in a unified sub-system architecture with a minimal CPU overhead
- > AURIX™ therefore provides the ability to run mixed-criticality software requiring real-time access while still enforcing encapsulation and freedom of interference between cores, even when the cores are not running time and memory-protected operating systems

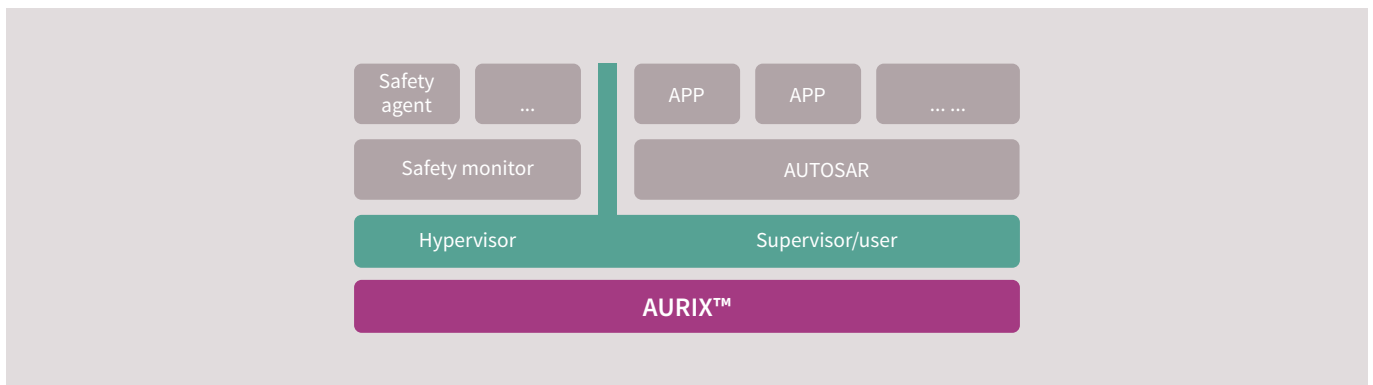

AURIX™ protection system overview

- > Hardware support for freedom of interference
 - Between SW components
 - Between HW parts
 - Between HW parts & SW components
- > Timing protection

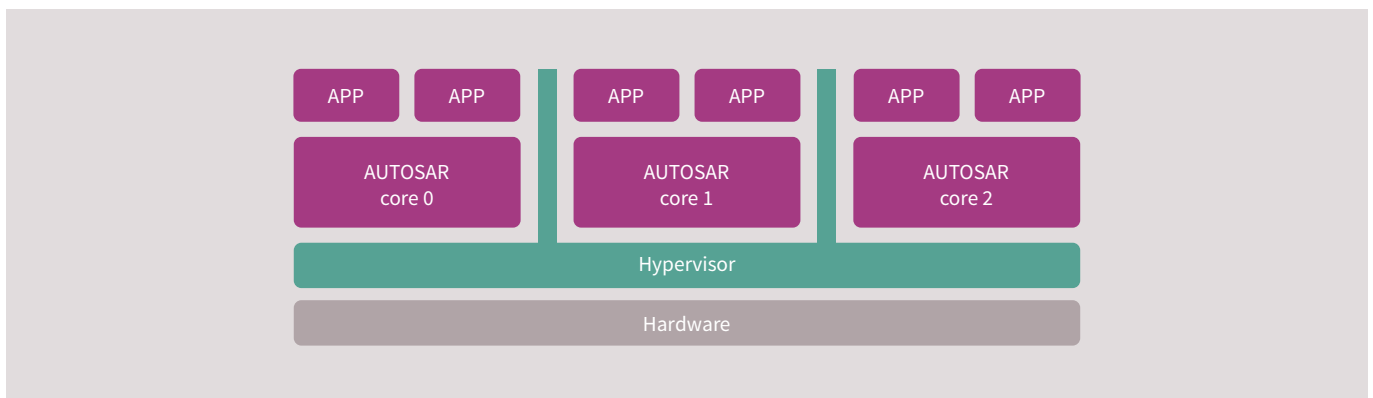

AURIX™ family communication innovation

AURIX™ MultiCAN

- > Up to 6 CAN nodes with FD support available
- > CAN standard V2.0 B active
- > ISO11898-1 FDIS 2014 CAN-FD
- > Specific AURIX™ variants support ISO11898-1 DIS 2015
- > Resonator ready with asynchronous operation and choice of clock source
- > Frequency scaling without baud rate change
- > Energy saving: pretended networking and partial networking (ISO11898-6 transceiver support) support (also in CAN FD mode)
- > Safety support: total amount of bus errors countable
- > Message objects can be freely assigned among the nodes
- > Configurable FIFO length, automatic gateway mode support
- > Acceptance mask filtering for each message object



Ethernet

Highlights

- > MAC integrated in μ C
- > IEEE 802.3-2002 for Ethernet with support of IP, TCP/IP, UDP ...
- > Real-time stamping support (IEEE 1588-2008) for clock synchronization
- > Standard MII and RMI interfaces to PHY
- > Fast Ethernet w/ 100 Mbit
- > AUTOSAR V4 features supported
- > Automatic CRC checksum and padding support
- > AVB support

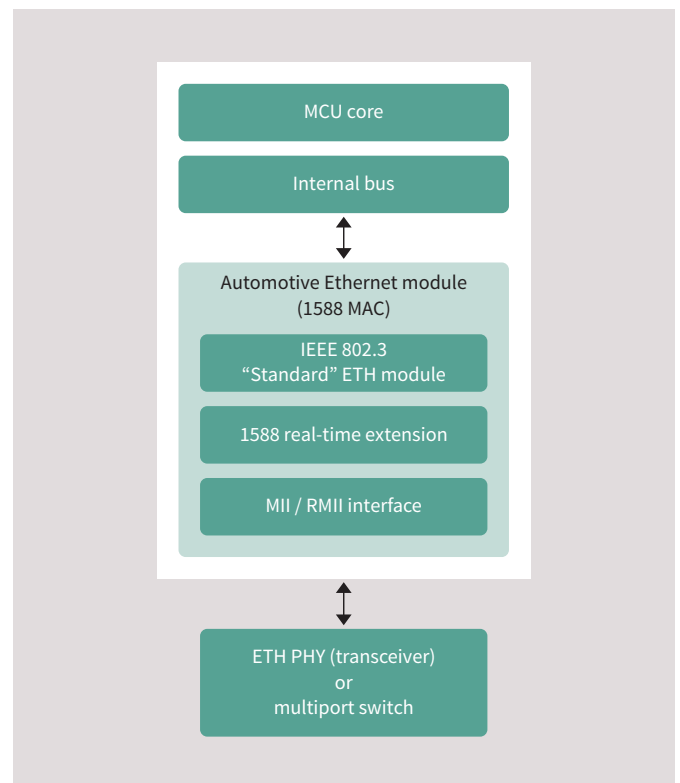

AURIX™ family offers a complete roadmap for automotive security

	TQFP-100	TQFP-144	LQFP-176	LFBGA-292	LFBGA-516	Bare Die
9x series up to 8 MB				TC297T 270 MHz HSM	TC299T 270 MHz HSM	TC290T 270 MHz HSM
7x series up to 4 MB			TC275T 200 MHz HSM	TC277T 200 MHz HSM		TC270T 200 MHz HSM
3x series up to 2 MB	TC233L 200 MHz HSM	TC234L 200 MHz HSM		TC237L 200 MHz HSM		

High-end engine & transmission management
 ADAS & sensor fusion domain control (H)EV System

Mid-range engine & transmission management
 High-end brake and EPS domain control (H)EV system

EPS airbag brake systems ADAS

Typical use cases

- > Secure on-board communication
- > Tuning protection
- > Immobilizer
- > Secure SW update

AURIX™ hardware security module – anchor of trust thanks to separated logical protection domain

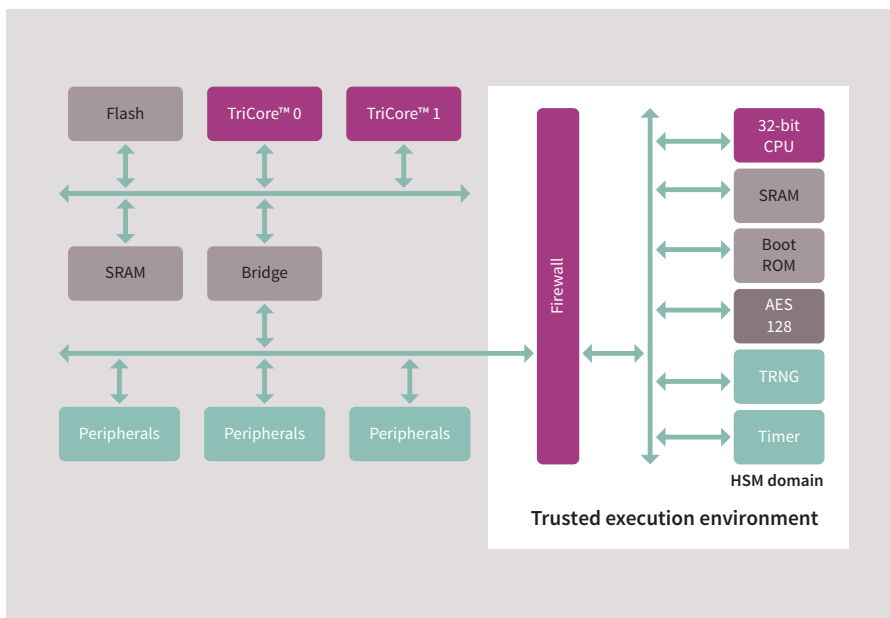

AURIX™ Hardware Security Module (HSM)

- > A highly flexible and programmable solution
 - AES128 and TRNG implemented in HW
 - Customer-specific requirements, such as HASH or asymmetric encryption, can be implemented in software
- > Offers the performance required to encrypt/decrypt e.g. Ethernet traffic
- > Secure key storage provided by separated HSM-DFLASH portion
 - Alternative secure key storage feasible in dedicated HSM-PFLASH sections
- > SHE+ software



The SHE+ driver controls the hardware security peripheral in the HSM domain and interacts with the TriCore™ host core. SHE+ offers the AUTOSAR CRY interface for integrating the HSM security features into an automotive application, including interface to AUTOSAR, communication from TriCore™ to HSM and vice versa, key storage functionality and security peripheral drivers.

AURIX™ security software

Infineon's AURIX™ 32-bit microcontroller family offers a wide portfolio of compatible devices with embedded Hardware Security Module (HSM), which offers cost-efficient solutions for all typical automotive security applications. The SHE+ driver controls the hardware security peripheral in the HSM domain and interacts with the TriCore™ host

core. SHE+ comes with the AUTOSAR CRY interface for integrating the HSM security features into an automotive application, including interface to AUTOSAR, communication from TriCore™ to HSM and vice versa, key storage functionality and security peripheral drivers.

	HIS SHE	HSM SHE+ V1	HSM SHE+ envisioned
Key management	10 keys	20 keys	Configurable
Symmetric data encryption / decryption	HW-based AES-128-bit (ECB, CBC)	HW-based AES-128-bit (ECB, CBC, OFB, CFB, CTR, XTC, GCM)	●
MAC generation / verification	●	●	●
Safe MAC verification	-	●	●
Random number management	SHE PRNG	SHE PRNG TRNG	●
Secure boot	●	-	●
Debug access	-	-	Enhanced by HSM debug options
Other SHE services	●	●	●
Asymmetric encryption / decryption	-	-	SW-based RSA1024 SW-based ECC256

Typical applications	Tuning protection 	Immobilizer  Secure-on-board communication 	Possible extensions, depending on specific tier1 / OEM use case
Key management	●	●	●
Symmetric data encryption / decryption	●	●	●
MAC generation / verification	●	●	●
Safe MAC verification		(optional)	(optional)
Random number management	●	●	●
Secure boot	(optional)	(optional)	(optional)
Debug access	(for development)	(for development)	(for development)
Other SHE services	●	●	●
Asymmetric encryption / decryption	(optional in future)	(optional in future)	(optional in future)

Embedded software

TriCore™ performance

Real-life application benchmark (software controlling a four-cylinder diesel engine)

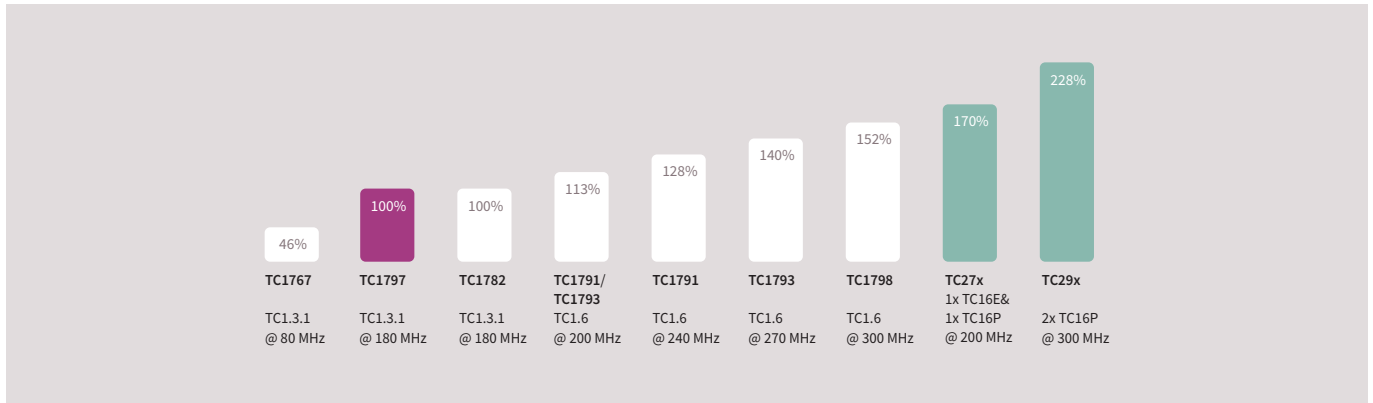

Assuming a multicore performance gain of 1.5 times

Infineon software product overview

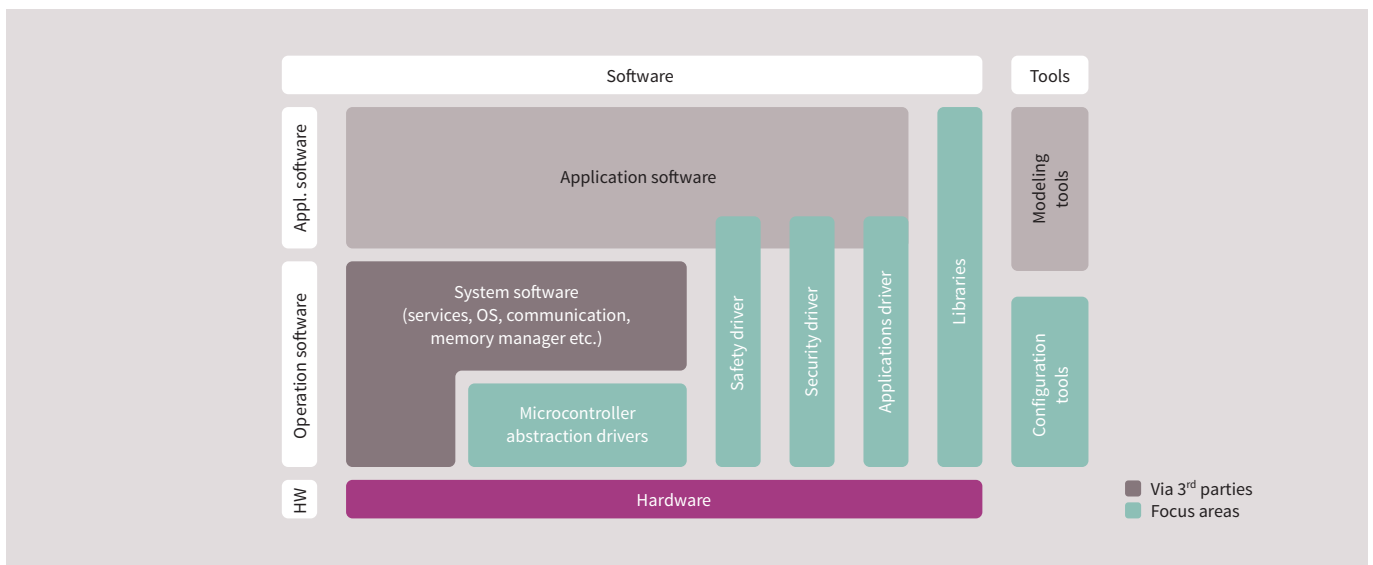

- > Microcontroller abstraction drivers
 - AUTOSAR MCAL
 - DAVE™
- > Safety drivers
 - PRO-SIL™ SafeTcore (AUDO MAX)
 - PRO-SIL™ SafeTlib (AURIX™)
- > Security Driver
 - SHE+ driver

- > System software
- > Configuration tool
 - DAVE™
- > Libraries
 - DSP library
- > Tools
 - MemTool etc.

Infinion AUTOSAR MCAL drivers

MC-ISAR product overview

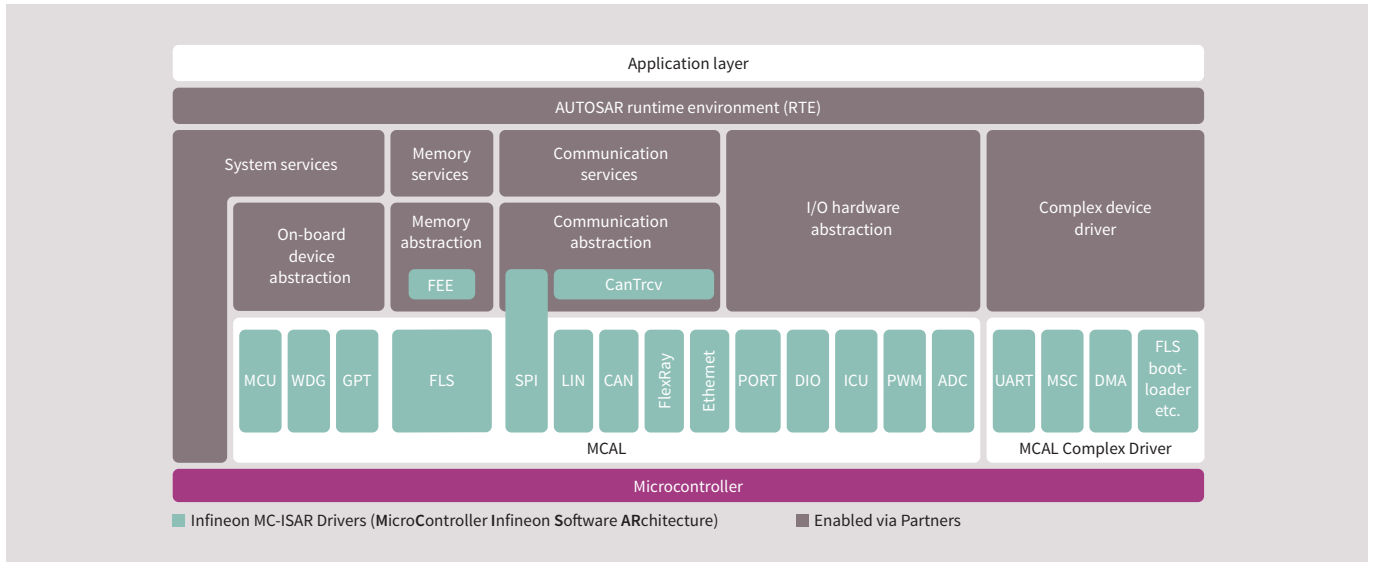

MC-ISAR	MicroController – Infineon Software ARchitecture
MC-ISAR:	MCU, WDG, GPT, SPI, PORT, DIO, ICU, PWM, ADC
MC-ISAR COM Basic:	CAN, CanTrcv, LIN
MC-ISAR COM Enhanced:	FlexRay, Ethernet
MC-ISAR MEM:	FLASH, FEE
MC-ISAR CD:	UART, MSC, DMA, FLSLoader for AURIX™
MC-ISAR DEMOCD:	HSSL, SENT, I2C, STM, DS-ADC, SMU, IOM for AURIX™ as demo code



> Supported AUTOSAR releases and devices

- V2.0: AUDO NG (TC1796, TC1766)
- V2.1, V3.0: XC2287, AUDO Future (TC1797, TC1767), AUDO S
- V3.1, V3.2: XC2000, AUDO MAX
- V4.03: AUDO MAX
- V3.2, V4.03: AURIX™
- ISO 26262 support

> Complex driver for non-standardized modules (for TriCore™)

- > CMM L3 process
- > AUTOSAR BSW suite via partners: elektrotbit, vector, KPIT, ETAS
- > Delivery packages include: source code, user manual, Tresos configuration tool

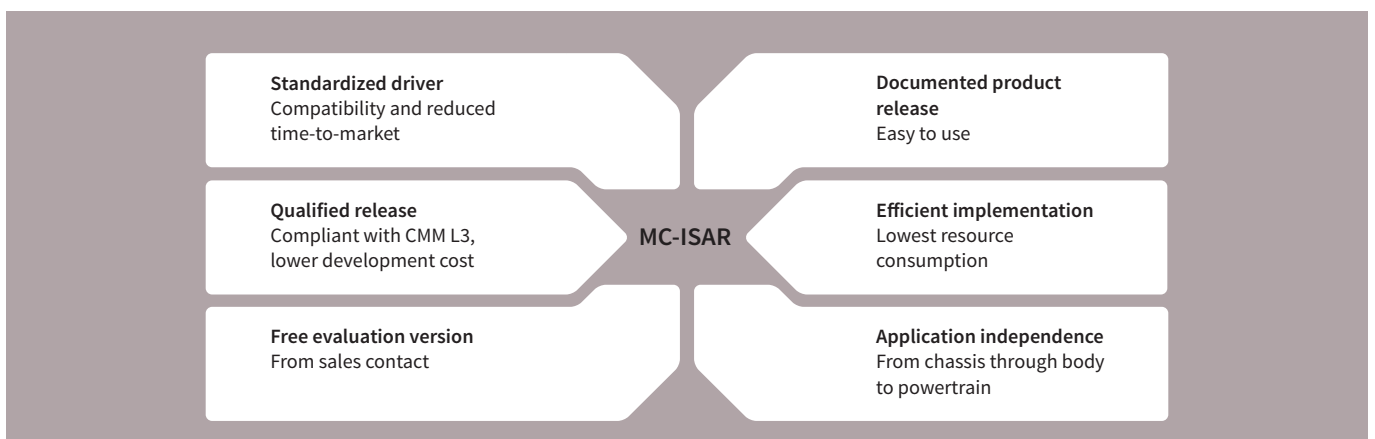

Development support

Emulation device

- › Emulation devices (ED) are a very powerful solution for calibration, measurement, rapid prototyping and debugging
- › Emulation logic and RAM are added next to the unchanged Production Device (PD) part on the same chip
- › Cost-optimized PD, feature-rich ED
- › Same package for ED and PD and minimum or no additional external circuitry allows highly cost-optimized ECU design
- › Proven solution with broad tool support by leading automotive and debug tool vendors

AURIX™ highlights

- › Up to 2 Mbyte RAM for calibration with same access speed as on-chip flash
- › Automotive measurement bandwidth (XCP) 15/30 Mbyte/s via regular 2/3-pin DAP interface

Trace and measurement

Today's vehicles are designed to meet rising market demands for engine performance, engine responsiveness, torque, drivability, fuel economy and emissions. Infineon's proven Multicore Debug Solution (MCDS) enables manufacturers to design and optimize features to support these automotive trends. Unique MCDS features include the fully time-aligned parallel trace of many different on-chip sources and its highly powerful trigger capabilities.

Multicore Debug Solution (MCDS)

Key features

- › Tracing of CPUs, busses, performance events and peripheral internal states
- › Real-time, cycle-accurate and in parallel
- › Up to 1 Mbyte on-chip trace RAM (40 Gbit/s bandwidth)
- › Very powerful trigger capabilities
- › No additional pins needed besides the DAP interface
- › New Compact Function Trace (CFT) mode for continuous program trace via DAP
- › New fine-grained data trace qualification for automotive measurement

AURIX™ starter and application kits

Infineon Technologies AG starter kits – 32-bit microcontrollers

Triboards

Infineon Tricore™ family starter kits are powerful evaluation systems that enable evaluation and development well before the target hardware is available. They offer a solid platform for both hardware and software engineers to evaluate and prototype designs that are closely aligned with their final applications.

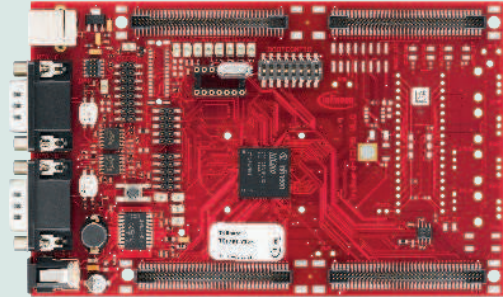

Application kits

To simplify the development of your own application, the kit comes with a variety of on-board components, including a highly integrated software development environment that gives you everything you need to compile, debug, and flash your AURIX™ multicore application.

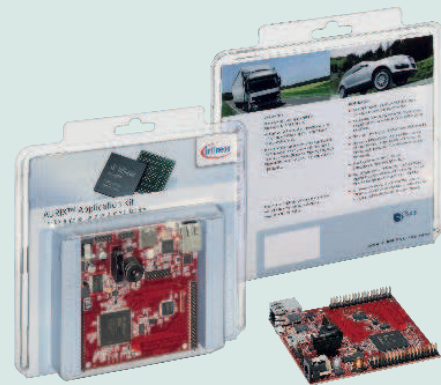

System application kits

The system application kits provide a quick jump-start to typical microcontroller applications such as motor control, radar etc. These reference design kits provide faster design-in support for end applications by providing a reference board, application software, tooling and documentation.



www.infineon.com/AURIX-kits

ACT- AURIX™ configuration tool

ACT is a powerful tool that helps engineers to jump-start programming of Infineon microcontrollers.

Key feature

- > Altium TASKING VX TriCore™ lite version including build-in
 - AURIX™ pin mapping incl. interactive package view
 - AURIX™ iLLD (Low-Level Driver)
 - AURIX™ OSEK

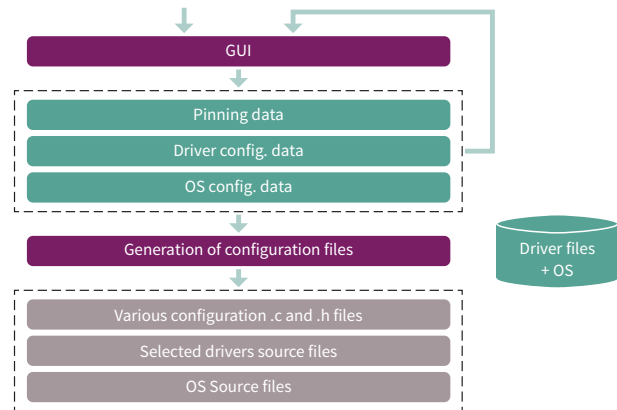

Free TriCore™ entry tool chain

This free of charge tooling entry tool chain provides all required features to develop and test software for TriCore™ and AURIX™. The tool can be used with all available TriCore™ and AURIX™ starter kits and application boards.

Key features

- > Eclipse based IDE
- > Project wizard to easy define the project properties for device and board support
- > High-performance GNU C compiler
- > Integrated source level debugger
- > On-chip flash programming support

For further information on TriCore™ Tools, please visit: www.infineon.com/tricore-tools

Preferred Design Houses (PDH)

Optimized open-market customer support set up for systems using AURIX™, including software and other Infineon products such as power products, sensor products and modules. They are trained to provide application- and product-specific support.

Classic (Free of charge)	<ul style="list-style-type: none"> > 1st level customer support ensuring Infineon products/solutions > Technical interface and support to the customer 	<ul style="list-style-type: none"> > Driving design @ customer > Basic training for design teams @ customer > 24 h response time to the customer
Premium (Consultancy mode) To be agreed between customers and PDH	<ul style="list-style-type: none"> > Project management & project-specific application support > Specification of general SW architecture, defining required layers, control and data flow structure etc. > Specification and implementation of custom device drivers > Optimization of software components with regard to speed/code size 	<ul style="list-style-type: none"> > Software testing > Support of project-specific functional safety engineering > Project-specific support of security solution > Safety support > Security support > Multicore support

Design houses:



For more information, please visit: www.infineon.com/pdh



AURIX™ for powertrain applications

Energy efficiency for combustion engine vehicles

Electronic automotive components are key to raising fuel efficiency levels and cutting emissions. The latest environment protection agency standards – Euro 5 and Euro 6 for passenger cars and Euro 3 and Euro 4 for motorcycles – are driving developments in advanced engine management. TriCore™ based products can be found in improved combustion technologies such as Homogeneous Charge Compression Ignition (HCCI) as well as in direct injection, smart turbocharger and valve actuation applications. They are also ideal for a range of innovative transmission technologies such as Double Clutch Transmission (DCT) and modern Continuous Variable Transmission (CVT).

Driving hybrid and electrification

While excelling in fuel economy, being fun-to-drive and reducing CO₂ emissions, Hybrid Electric Vehicles (HEV) and Electric Vehicles (EV) have the drawbacks of higher cost, limited drive-range and safety concerns (e.g. risk of battery over-charging). TriCore™ products, with their high performance, functional integration and application-based SW support, are the ideal solution for (H)EV motor drives. TriCore™ offers less than 3% CPU load at 300 MHz frequen-

cy, for the complete Field-Oriented Control (FOC) algorithm. TriCore™ AURIX™ family offers multicore architecture, allowing inverter control, hybrid torque management and DC/DC conversion to be done within one single microcontroller. Nevertheless, the TriCore™ AURIX™ family has built-in resolver functionality, saving customers the cost of implementing an external resolver IC.

Often seen as master micro in battery balancing topology, the TriCore™ AURIX™ family proposes a 32-bit standby domain combined with an integrated 8-bit standby controller, essential for battery balancing under low power mode (e.g. holiday parking). Infineon is market leader in offering Hardware Security Module (HSM), a feature that prevents the main CPU from illegal manipulation, making the billing for battery charging more trustworthy.

AURIX™ security hardware

Infineon's AURIX™ 32-bit microcontroller family offers a wide portfolio of compatible devices, with embedded Hardware Security Module (HSM), which offer cost-efficient solutions for all typical automotive security applications.



Hardware Security Module (HSM)

HSM provides a secure computing platform, consisting of a 32-bit CPU, special access-protected memory for storing the cryptographic key and the unique subscriber identifiers, a hardware accelerator for the state-of-the-art AES-128 encryption that can be operated in different modes and specific hardware for generation of random numbers. A firewall separates HSM from the rest of AURIX™ microcontroller.

- › A highly flexible and programmable solution
- › AES-128 HW accelerator matching performance for automotive protocols
- › Crypto- and Algorithm Agility by software
- › AIS31 compliant True Random Number Generator (TRNG) with high random entropy over lifetime

Customer benefits

- › **Secure platform** – HSM provides a secure platform, separated from the rest of the microcontrollers by a firewall, thereby creating a trusted execution environment.
- › **Security standard compliance** – AURIX™ HSM fulfills SHE HIS and Evita Medium standards as well as provide some additional functionalities.
- › **Backward compatibility** – AURIX™ security solutions are backward compatible to security SHE HIS implementations in previous TriCore™ based microcontroller families.
- › **Security differentiation** - customized secure OEM or Tier1 crypto apps can be processed within trusted HSM execu-

tion environment and therefore allow independent HSM specific SW code review in reference to the huge application host SW from multiple parties. This helps to harden the security level by reliably avoiding potential security backdoors.

- › **Convergence of security and safety** – AURIX™ microcontrollers address both functional safety as well as IT-security requirements, making sure those are properly integrated and not conflicting with one another.
- › **Secure process** – Infineon can provide a secure personalization flow. 1st personalization step usually happens at the Tier1, where initial HSM SW and optional transportation key(s) are injected to the ECU. 2nd personalization step happens at the OEM, where a car specific Individual key(s) are injected. AURIX™ HSM offers device specific, individual random read-only key. Read-only key can be used for injected keys and make them invisible for the application SW layer.
- › **Secure failure analysis** – for the purpose of preventing unpermitted debug access, AURIX™ HSM offers 256-bit password for debugger access protection. It is possible to create car specific debugger password, which can be stored in OEM/Tier1 data base or generated by secret algorithm. Destructive debugger entry functionality opens debugger access but initiates a persistent destructive action – device gets inoperable in native ECU car environment.

Gasoline direct injection

Application example

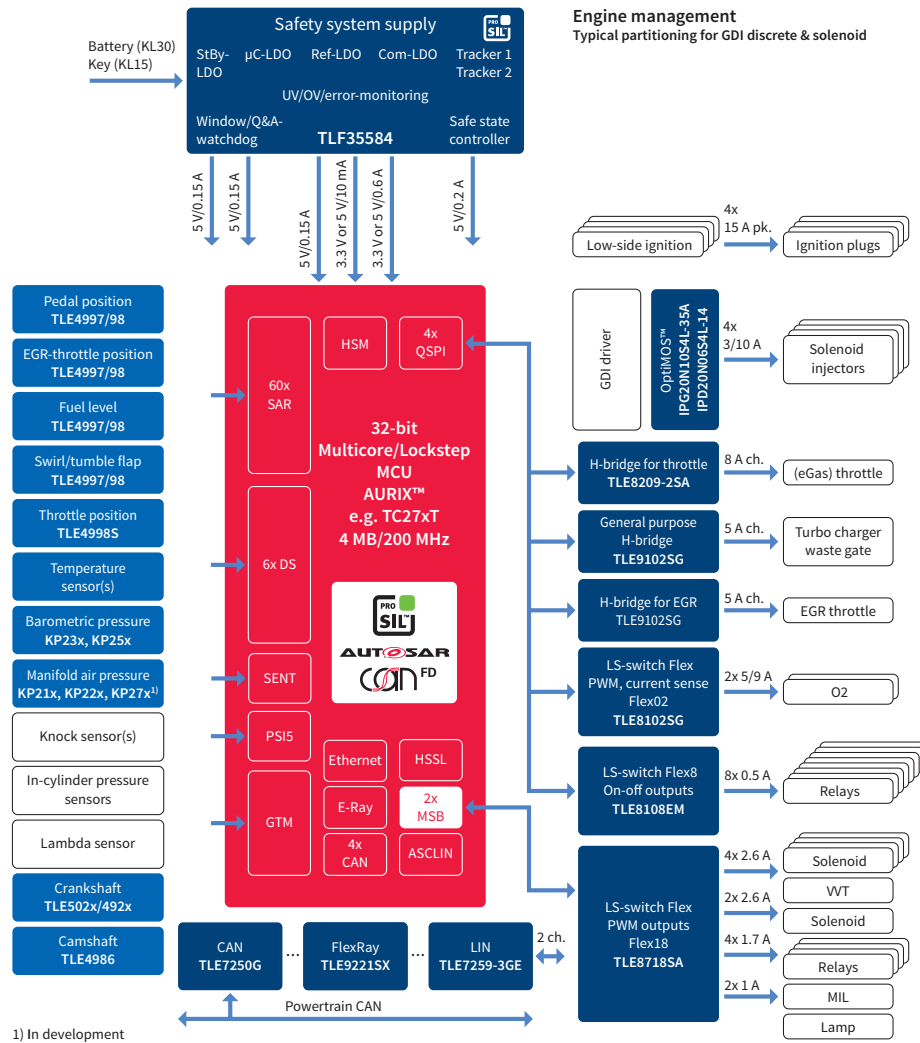

The new TriCore™ family AURIX™ with state-of-the-art safety features enables systems to achieve the highest safety level up to ASIL-D. The scalable AURIX™ family includes the GTM, the de-facto industry standard timing module that supports highly complex engine management, while meeting the market's most stringent emissions regulations.

Application features

- › Direct injection
- › Scalable software-based knock detection
- › Variable valve control
- › Throttle and EGR control
- › Turbo charging
- › Catalyist after treatment
- › Start/stop system

System benefits

- › Microcontroller with best-in-class real-time performance
- › Scalable platform – performance, memory size and I/Os
- › Committed to reduce CO₂ by 20%
- › Anti-theft protection and tuning protection
- › Increased knock detection accuracy via DS-ADC
- › Enhanced communication (Ethernet)
- › Dedicated peripherals for powertrain

Suggested products

- › TC27x – TriCore™ 32-bit microcontroller
- › TC26x – TriCore™ 32-bit microcontroller



Gasoline multi-port injection – discrete solution

Application example

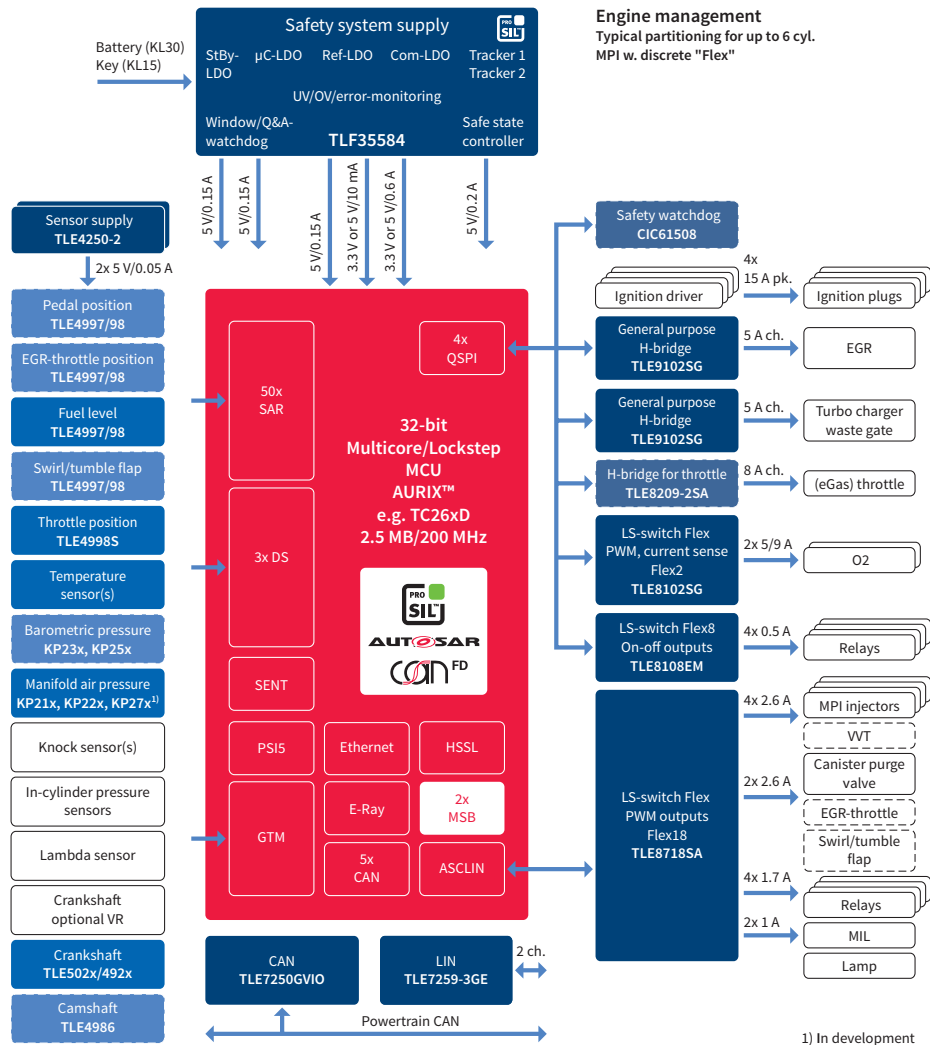

The new TriCore™ family AURIX™ with state-of-the-art safety features enables systems to achieve the highest safety level up to ASIL-D. The scalable AURIX™ family includes the GTM, the de-facto industry standard timing module that supports highly complex engine management, while meeting the market's most stringent emissions regulations.

Application features

- › Gasoline port injection
- › Scalable software-based knock detection
- › Throttle and EGR control
- › Catalyst after treatment
- › Start/stop systems
- › Cost-optimized for entry segment

System benefits

- › Scalable platform – performance, memory size and I/Os
- › Single voltage supply (EVR)
- › Focus on reducing CO₂
- › Easy migration from ultra low-end to mid-range applications
- › Best tool/partner support for all development phases within V-cycle

Suggested products

- › TC265 – TriCore™ 32-bit microcontroller
- › TC264 – TriCore™ 32-bit microcontroller



Diesel direct injection

Application example

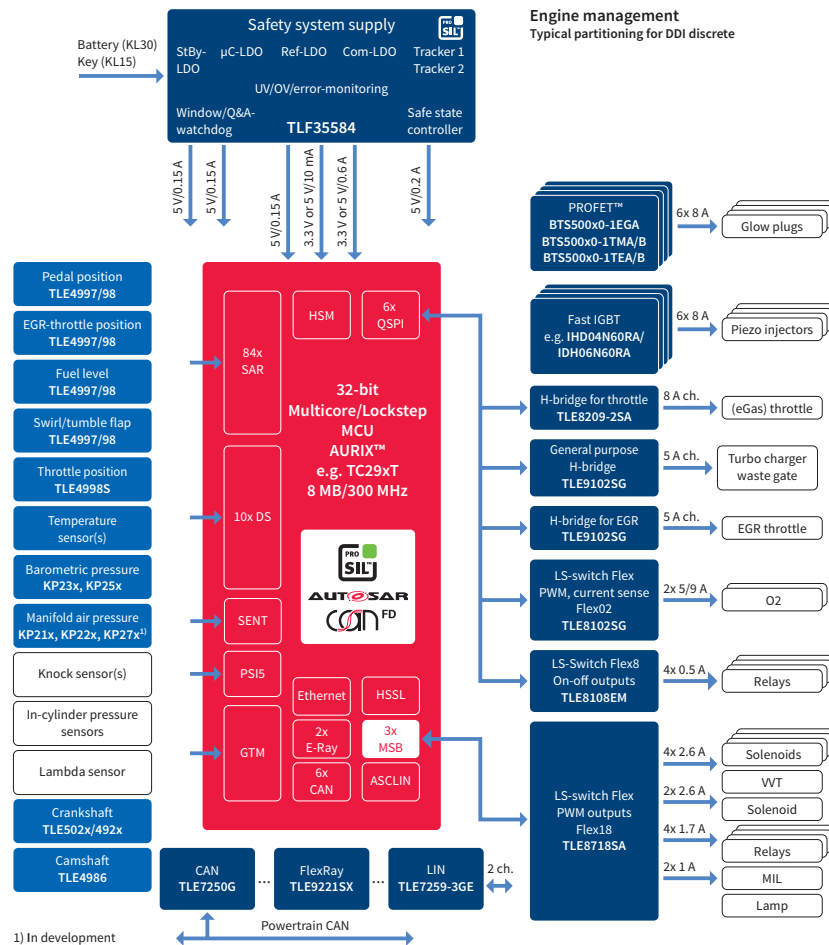

The new TriCore™ family AURIX™ with state-of-the-art safety features enables systems to achieve the highest safety level up to ASIL-D. The scalable AURIX™ family includes the GTM, the de-facto industry standard timing module that supports highly complex engine management, while meeting the market's most stringent emissions regulations.

Application features

- › Direct injection (piezo/magnetic)
- › In-cylinder pressure measurement
- › Hardware-supported security enhancements
- › Throttle and EGR control
- › Turbo charging
- › Diesel particulate filter
- › 'Blue' after-treatment support (e.g. urea-based SCR)

Suggested products

- › TC29x – TriCore™ 32-bit microcontroller
- › TC27x – TriCore™ 32-bit microcontroller

System benefits

- › Microcontroller with best-in-class real-time performance
- › Scalable platform – performance, memory size and I/Os
- › Committed to reduce NOx and particulate matter in line with Euro 6 standard
- › Hardware-supported IP/anti-theft protection and tuning protection
- › Increased accuracy with in-cylinder pressure sensing via DS-ADC
- › Enhanced communication (Ethernet)
- › Dedicated peripherals for powertrain



Automatic transmission – hydraulic control

Application example

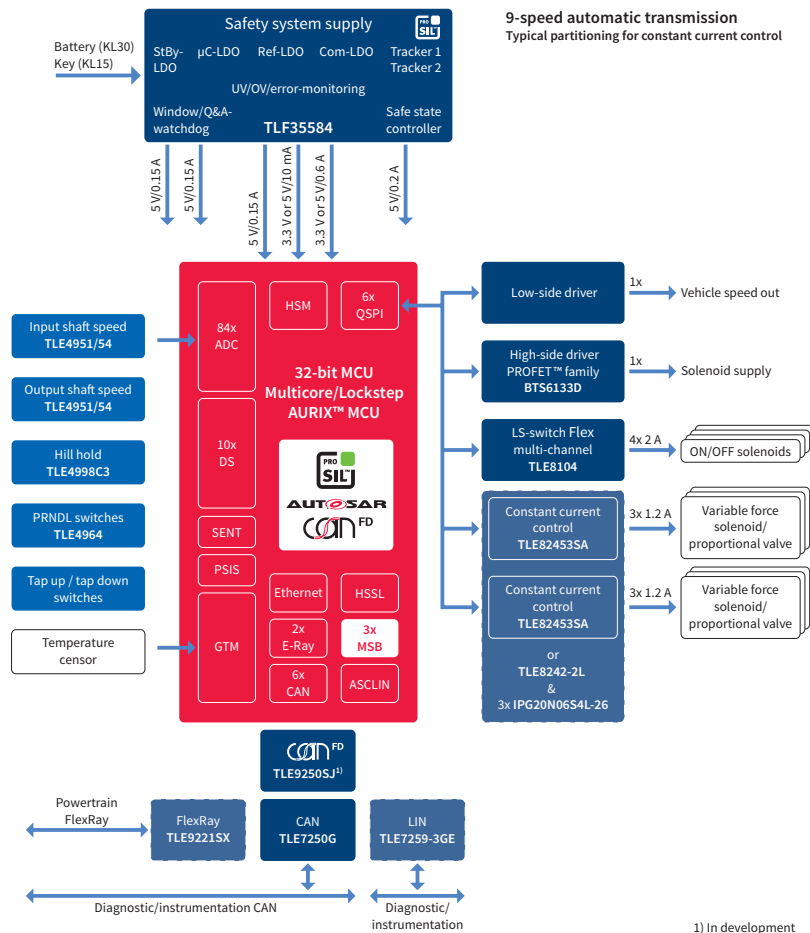

The new TriCore™ family AURIX™ with state-of-the-art safety features enables systems to achieve the highest safety level up to ASIL-D. The rich scalability of the AURIX™ family permits a platform approach that meets the needs of a range of transmission system demands. Furthermore, the hot temperature package and bare die solutions enable AURIX™ to be used in both attached and integrated control units.

Application features

- › Smooth gear shifting
- › Closely coupled with engine control via high-speed CAN/CAN-FD/FlexRay link
- › Support of four 3-phase DC-brushless E-drives
- › TC270: high microcontroller junction bare die temperature
- › TC275/TC277: extended ambient temperature range to meet harsh environment requirements

System benefits

- › Improved and fast clutch control
- › Supports Safety Level up to ASIL-D
- › Security module HSM to prevent tampering
- › Hot bare die supports modular temperature-optimized TCU design
- › Hot bare die capabilities enable microcontrollers to be placed wherever they are needed in the system
- › Scalable product offering ensures perfect fit for individual application needs

Suggested products

- › TC29x – TriCore™ 32-bit microcontroller
- › TC27x – TriCore™ 32-bit microcontroller
- › TC270 – Bare die TriCore™ 32-bit microcontroller

