



Chipsmall Limited consists of a professional team with an average of over 10 year of expertise in the distribution of electronic components. Based in Hongkong, we have already established firm and mutual-benefit business relationships with customers from,Europe,America and south Asia,supplying obsolete and hard-to-find components to meet their specific needs.

With the principle of "Quality Parts,Customers Priority,Honest Operation,and Considerate Service",our business mainly focus on the distribution of electronic components. Line cards we deal with include Microchip,ALPS,ROHM,Xilinx,Pulse,ON,Everlight and Freescale. Main products comprise IC,Modules,Potentiometer,IC Socket,Relay,Connector.Our parts cover such applications as commercial,industrial, and automotives areas.

We are looking forward to setting up business relationship with you and hope to provide you with the best service and solution. Let us make a better world for our industry!



## Contact us

Tel: +86-755-8981 8866 Fax: +86-755-8427 6832

Email & Skype: info@chipsmall.com Web: www.chipsmall.com

Address: A1208, Overseas Decoration Building, #122 Zhenhua RD., Futian, Shenzhen, China



## Thermal Sensor with SPI Interface

### Features

- Digital Temperature Sensing in 5-Pin SOT-23A and 8-Pin SOIC Packages
- Outputs Temperature as a 13-Bit Digital Word
- SPI and MICROWIRE™ Compatible Interface
- Solid State Temperature Sensing
- ±1°C (max.) accuracy from +25°C to +65°C
- ±2°C (max.) accuracy from -40°C to +85°C
- ±3°C (max.) accuracy from -55°C to +125°C
- 2.7V to 5.5V Operating Range
- Low Power
  - 250 µA (typ.) Continuous Conversion Mode
  - 0.1 µA (typ.) Shutdown Mode

### Typical Applications

- Thermal Protection for Hard Disk Drives and Other PC Peripherals
- PC Card Devices for Notebook Computers
- Low Cost Thermostat Controls
- Industrial Control
- Office Equipment
- Cellular Phones
- Thermistor Replacement

### Block Diagram

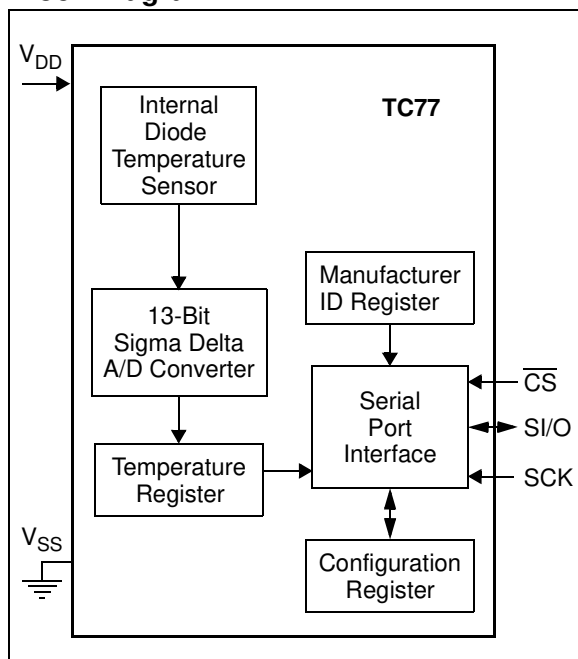

### Description

The TC77 is a serially accessible digital temperature sensor particularly suited for low cost and small form-factor applications. Temperature data is converted from the internal thermal sensing element and made available at anytime as a 13-bit two's complement digital word. Communication with the TC77 is accomplished via a SPI and MICROWIRE compatible interface. It has a 12-bit plus sign temperature resolution of 0.0625°C per Least Significant Bit (LSb). The TC77 offers a temperature accuracy of ±1.0°C (max.) over the temperature range of +25°C to +65°C. When operating, the TC77 consumes only 250 µA (typ.). The TC77's Configuration register can be used to activate the low power Shutdown mode, which has a current consumption of only 0.1 µA (typ.). Small size, low cost and ease of use make the TC77 an ideal choice for implementing thermal management in a variety of systems.

### Package Types

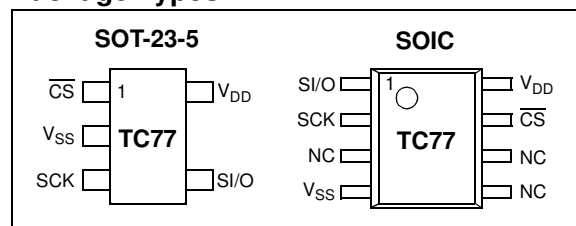

### Typical Application

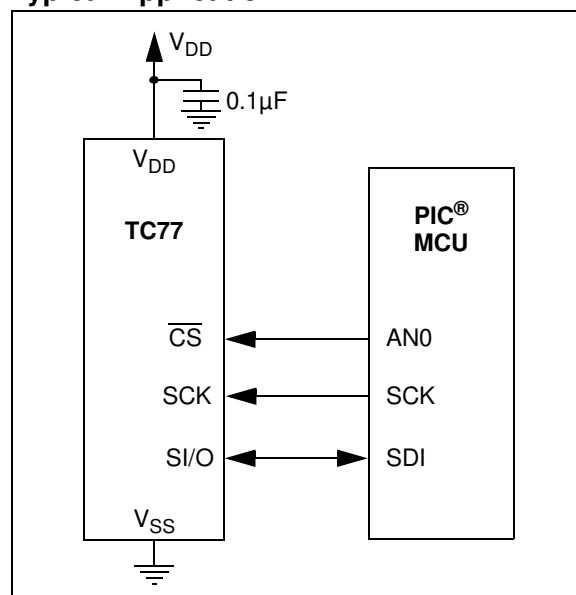

# TC77

## 1.0 ELECTRICAL CHARACTERISTICS

### 1.1 Absolute Maximum Ratings †

$V_{DD}$  ..... 6.0V  
 All inputs and outputs w.r.t.  $V_{SS}$  ..... -0.3V to  $V_{DD}$  +0.3V  
 Storage temperature ..... -65°C to +150°C  
 Ambient temp. with power applied ..... -55°C to +125°C  
 Junction Temperature ..... 150°C

ESD protection on all pins:

Human Body Model (HBM) ..... >4 kV

Machine Model (MM) ..... >200V

† **Notice:** Stresses above those listed under "Maximum Ratings" may cause permanent damage to the device. This is a stress rating only and functional operation of the device at those or any other conditions above those indicated in the operation listings of this specification is not implied. Exposure to maximum rating conditions for extended periods may affect device reliability.

## PIN FUNCTION TABLE

Name	Function
SI/O	Serial Data Pin
SCK	Serial Clock
$V_{SS}$	Ground
$\overline{CS}$	Chip Select (Active-Low)
NC	No Connection
$V_{DD}$	Power Supply

## DC CHARACTERISTICS

<b>Electrical Specifications:</b> Unless otherwise noted, all parameters apply at $V_{DD} = 2.7V$ to $5.5V$ and $T_A = -55^\circ C$ to $+125^\circ C$ .						
Parameters	Sym	Min	Typ	Max	Units	Conditions
<b>Power Supply</b>						
Operating Voltage Range	$V_{DD}$	2.7	—	5.5	V	<b>Note 1</b>
Operating Current	$I_{DD}$	—	250	400	$\mu A$	Continuous Temperature Conversion Mode
Power-On Reset Threshold	$V_{POR}$	1.2	1.6	2.2	V	$V_{DD}$ falling or rising edge
Standby Supply Current	$I_{DD-}$ STANDBY	—	0.1	1.0	$\mu A$	Shutdown Mode
<b>Temperature to Bits Converter</b>						
Resolution		—	13	—	Bits	ADC LSB = $0.0625^\circ C/bit$ <b>(Note 4)</b>
Temperature Conversion Time	$t_{CT}$	—	300	400	ms	
Temperature Accuracy <b>(Note 1)</b>	$T_{ERR}$	-1.0 -2.0 -3.0	— — —	+1.0 +2.0 +3.0	$^\circ C$	+25 $^\circ C$ < $T_A$ < +65 $^\circ C$ -40 $^\circ C$ < $T_A$ < +85 $^\circ C$ -55 $^\circ C$ < $T_A$ < +125 $^\circ C$ TC77-3.3MXX: $V_{DD} = 3.3V$ TC77-5.0MXX: $V_{DD} = 5.0V$

**Note 1:** The TC77-3.3MXX and TC77-5.0MXX will operate from a supply voltage of 2.7V to 5.5V. However, the temperature accuracy of the TC77-3.3MXX and TC77-5.0MXX is specified at the nominal operating voltages of 3.3V and 5.0V, respectively. As  $V_{DD}$  varies from the nominal operating value, the accuracy may be degraded (Refer to Figures 2-6 and 2-7).

**2:** All time measurements are measured with respect to the 50% point of the signal.

**3:** Load Capacitance,  $C_L = 80$  pF, is used for AC timing measurements of output signals.

**4:** Resolution = Temperature Range/No. of Bits =  $(+255^\circ C - -256^\circ C) / (2^{13})$   
 Resolution =  $512/8192 = 0.0625^\circ C/Bit$

## DC CHARACTERISTICS (CONTINUED)

<b>Electrical Specifications:</b> Unless otherwise noted, all parameters apply at $V_{DD} = 2.7V$ to $5.5V$ and $T_A = -55^{\circ}C$ to $+125^{\circ}C$ .						
Parameters	Sym	Min	Typ	Max	Units	Conditions
<b>Digital Input/Output</b>						
High Level Input Voltage	$V_{IH}$	$0.7 V_{DD}$	—	$V_{DD} + 0.3$	V	
Low Level Input Voltage	$V_{IL}$	-0.3	—	$0.3 V_{DD}$	V	
High Level Output Voltage	$V_{OH}$	2.4	—	—	V	$I_{OH} = -400 \mu A$
Low Level Output Voltage	$V_{OL}$	—	—	0.4	V	$I_{OL} = +2 mA$
Input Current	$I_{IN(0)}$ , $I_{IN(1)}$	-1.0 -1.0	— —	+1.0 +1.0	$\mu A$	$V_{IN} = GND$ $V_{IN} = V_{DD}$
Input Hysteresis		0.35	0.8	—	V	SI/O, SCK
Pin Capacitance	$C_{IN}$ , $C_{OUT}$	—	20	—	pF	
Tri-state Output Leakage Current	$I_{O\_LEAK}$	-1.0 —	— —	— +1.0	$\mu A$	$V_O = GND$ $V_O = V_{DD}$
<b>Serial Port AC Timing (Notes 2, 3)</b>						
Clock Frequency	$f_{CLK}$	DC	—	7.0	MHz	
$\overline{CS}$ Fall to First Rising SCK Edge	$t_{CS-SCK}$	100	—	—	ns	
$\overline{CS}$ Low to Data Out Delay	$t_{CS-SI/O}$	—	—	70	ns	
SCK Fall to Data Out Delay	$t_{DO}$	—	—	100	ns	
$\overline{CS}$ High to Data Out Tri-state	$t_{DIS}$	—	—	200	ns	
SCK High to Data In Hold Time	$t_{HD}$	50	—	—	ns	
Data In Set-up Time	$t_{SU}$	30	—	—	ns	
<b>Thermal Package Resistance</b>						
Thermal Resistance, SOT23-5	$\theta_{JA}$	—	230	—	$^{\circ}C/W$	
Thermal Resistance, 8L-SOIC	$\theta_{JA}$	—	163	—	$^{\circ}C/W$	

**Note 1:** The TC77-3.3MXX and TC77-5.0MXX will operate from a supply voltage of 2.7V to 5.5V. However, the temperature accuracy of the TC77-3.3MXX and TC77-5.0MXX is specified at the nominal operating voltages of 3.3V and 5.0V, respectively. As  $V_{DD}$  varies from the nominal operating value, the accuracy may be degraded (Refer to Figures 2-6 and 2-7).

- 2: All time measurements are measured with respect to the 50% point of the signal.
- 3: Load Capacitance,  $C_L = 80 pF$ , is used for AC timing measurements of output signals.
- 4: Resolution = Temperature Range/No. of Bits =  $(+255^{\circ}C - -256^{\circ}C) / (2^{13})$   
Resolution =  $512/8192 = 0.0625^{\circ}C/Bit$

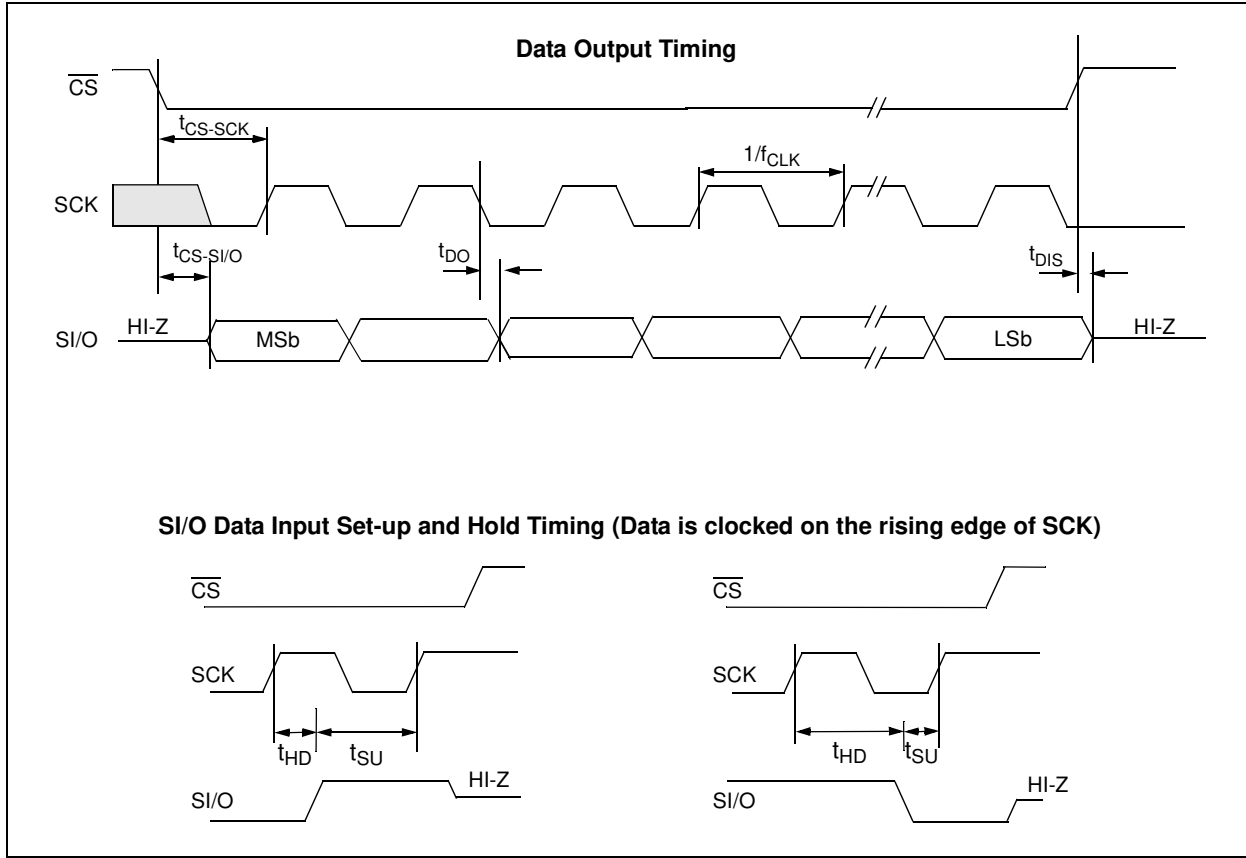
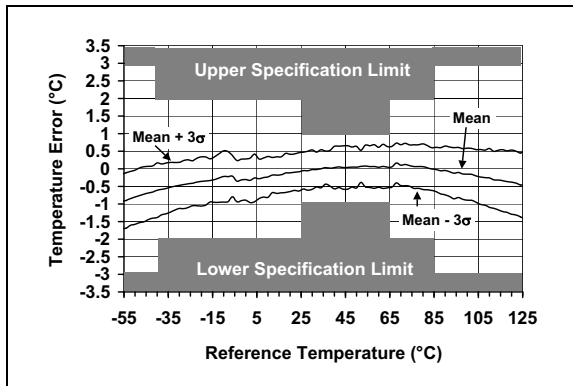

**FIGURE 1-1:** Timing Diagrams.

## 2.0 TYPICAL PERFORMANCE CURVES

**Note:** The graphs and tables provided following this note are a statistical summary based on a limited number of samples and are provided for informational purposes only. The performance characteristics listed herein are not tested or guaranteed. In some graphs or tables, the data presented may be outside the specified operating range (e.g., outside specified power supply range) and therefore outside the warranted range.

**Note:** Unless otherwise indicated, all parameters apply at  $V_{DD} = 3.3V$  for the TC77-3.3MXX and  $V_{DD} = 5.0V$  for the TC77-5.0MXX, and  $T_A = -55^{\circ}C$  to  $+125^{\circ}C$ . The TC77-3.3MXX and TC77-5.0MXX will operate from a supply voltage of 2.7V to 5.5V. However, the temperature accuracy of the TC77-3.3MXX and TC77-5.0MXX is specified at the nominal operating voltages of 3.3V and 5.0V, respectively.



**FIGURE 2-1:** Accuracy vs. Temperature (TC77-XXMXX).

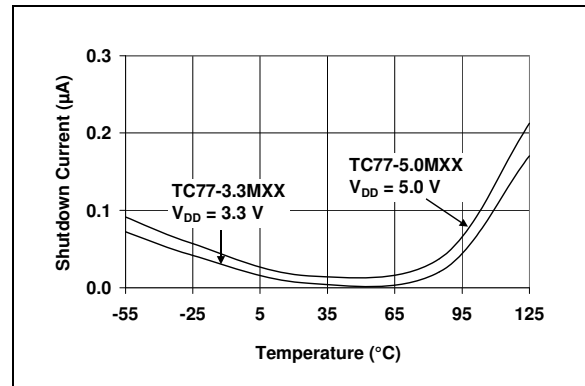

**FIGURE 2-4:** Shutdown Current vs. Temperature.

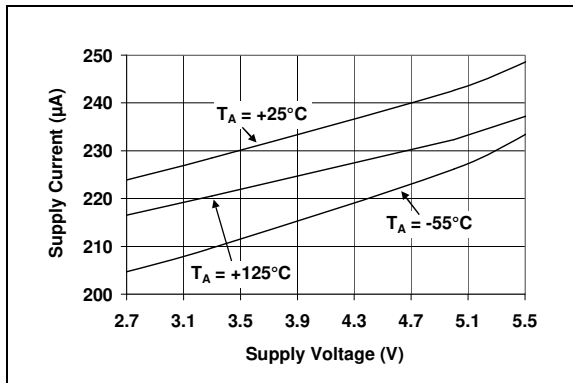

**FIGURE 2-2:** Supply Current vs. Supply Voltage (TC77-XXMXX).

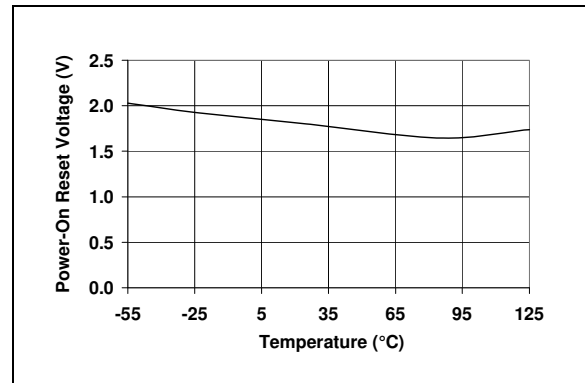

**FIGURE 2-5:** Power-On Reset Voltage vs. Temperature (TC77-XXMXX).

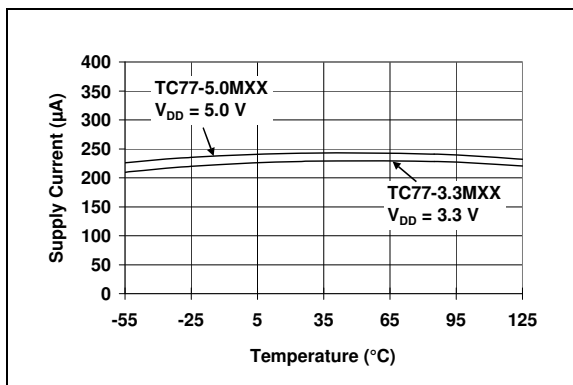

**FIGURE 2-3:** Supply Current vs. Temperature.

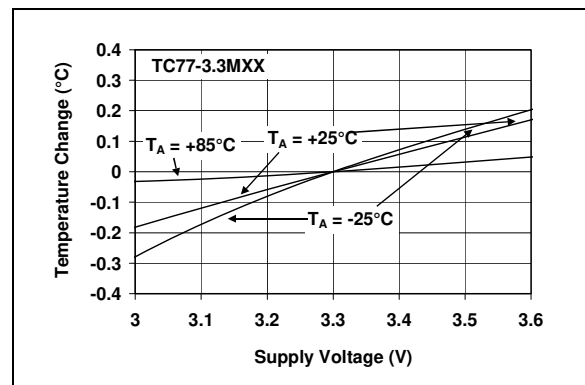

**FIGURE 2-6:** Temperature Accuracy vs. Supply Voltage (TC77-3.3MXX).

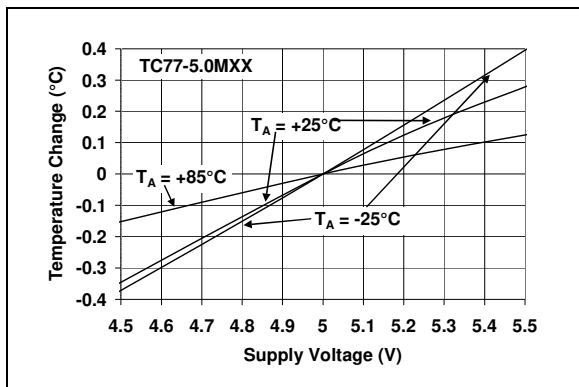

**FIGURE 2-7:** Temperature Accuracy vs. Supply Voltage (TC77-5.0MXX).

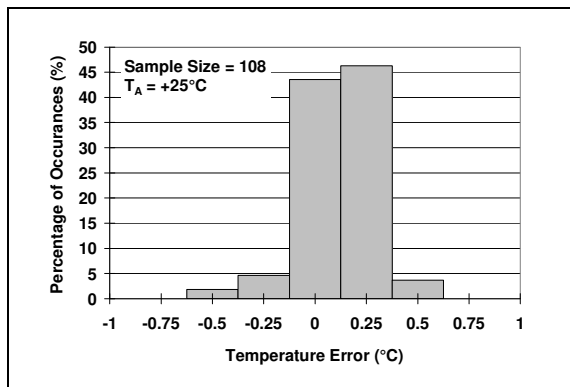

**FIGURE 2-10:** Histogram of Temperature Accuracy at +25 Degrees C (TC77-XXMXX).

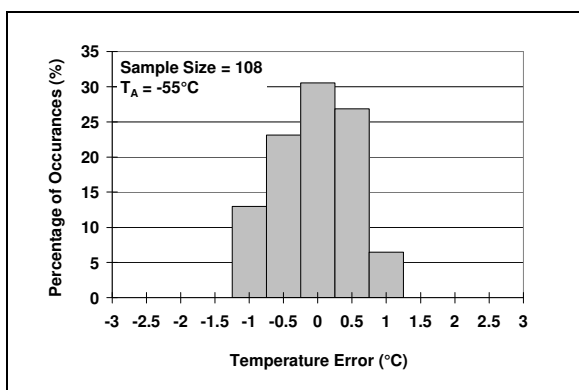

**FIGURE 2-8:** Histogram of Temperature Accuracy at -55 Degrees C (TC77-XXMXX).

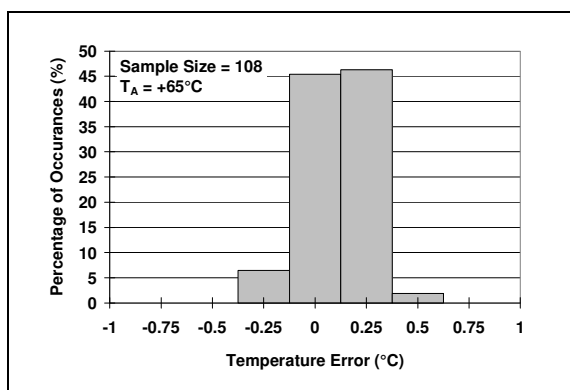

**FIGURE 2-11:** Histogram of Temperature Accuracy at +65 Degrees C (TC77-XXMXX).

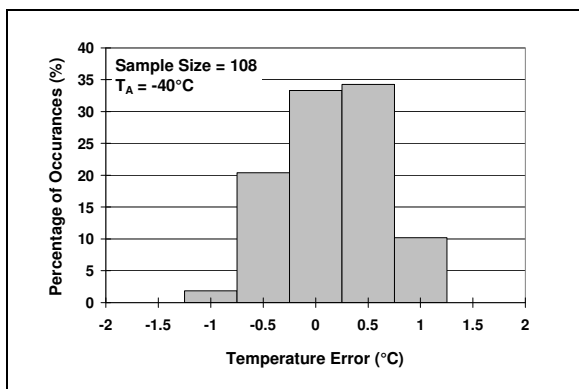

**FIGURE 2-9:** Histogram of Temperature Accuracy at -40 Degrees C (TC77-XXMXX).

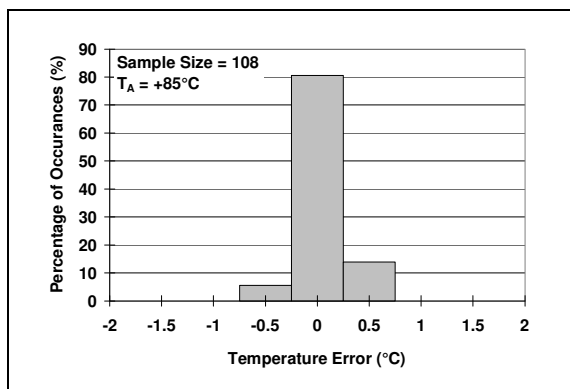

**FIGURE 2-12:** Histogram of Temperature Accuracy at +85 Degrees C (TC77-XXMXX).

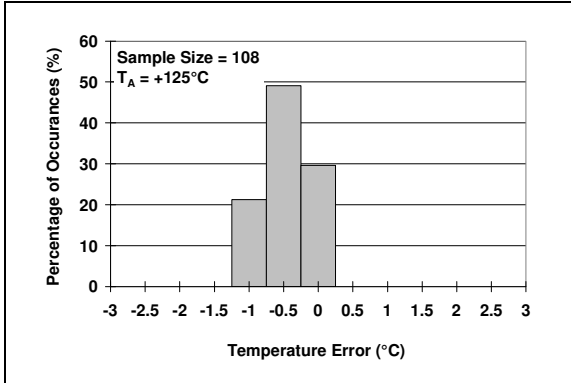

**FIGURE 2-13:** Histogram of Temperature Accuracy at +125 Degrees C (TC77-XXMXX).



# TC77

## 3.0 FUNCTIONAL DESCRIPTION

The TC77 consists of a band-gap type temperature sensor, a 12-bit plus sign (13-bit) Sigma-Delta Analog-to-Digital Converter (ADC), an internal conversion oscillator (~30 kHz) and a serial input/output port. These devices feature a three-wire serial interface that is fully compatible with SPI and MICROWIRE specifications and, therefore, allows simple communications with common microcontrollers and processors. The Shutdown mode can be used to reduce supply current for power sensitive applications. A Manufacturer's ID register identifies the TC77 as a Microchip Technology product.

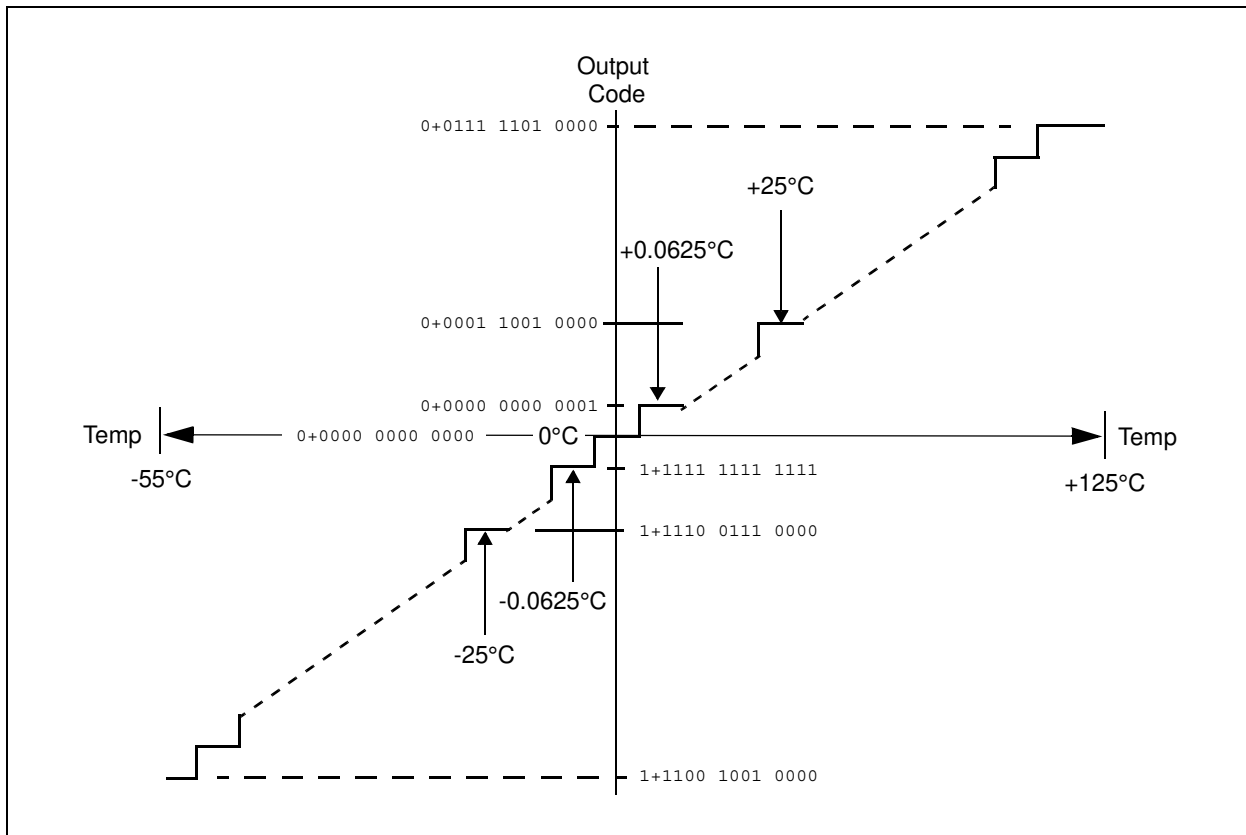

**FIGURE 3-1:** Temperature To Digital Transfer Function (Non-linear Scale).

## 3.1 Temperature Data Format

A 13-bit two's complement digital word is used to represent the temperature. The Least Significant Bit (LSb) is equal to 0.0625°C. Note that the last two LSb bits (Bit 0 and 1) are tri-stated and are represented as a logic '1' in the table. Bit 2 is set to logic '1' after the completion of the first temperature conversion following a power-up or voltage reset event.

**TABLE 3-1: TC77 OUTPUT**

Temperature	Binary MSB / LSB	Hex
+125°C	0011 1110 1000 0111	3E 87h
+25°C	0000 1100 1000 0111	0B 87h
+0.0625°C	0000 0000 0000 1111	00 0Fh
0°C	0000 0000 0000 0111	00 07h
-0.0625°C	1111 1111 1111 1111	FF FFh
-25°C	1111 0011 1000 0111	F3 87h
-55°C	1110 0100 1000 0111	E4 87h

An over-temperature condition can be determined by reading only the first few Most Significant Bits (MSb) of the temperature data. For example, the microprocessor could read only the first four bits of the Temperature register in order to determine that an over-temperature condition exists.

## 3.2 Power-Up And Power-Down

The TC77 is in the Continuous Temperature Conversion mode at power-up. The first valid temperature conversion will be available approximately 300 ms (refer to "Temperature to Bits Converter" section listed in the DC characteristics table) after power-up. Bit 2 of the Temperature register is set to a logic '1' after the completion of the first temperature conversion following a power-up or voltage reset event. Bit 2 is set to logic '0' during the time needed to complete the first temperature conversion. Thus, the status of bit 2 can be monitored to indicate the completion of the first temperature conversion.

A supply voltage lower than 1.6V (typ.) is considered a power-down state for the TC77. The device will reset itself and continue its normal Continuous Conversion mode of operation when the supply voltage rises above the nominal 1.6V. A minimal supply voltage of 2.7V is required in order to ensure proper operation of the device.

## 3.3 Serial Bus Interface

The serial interface consists of the Chip Select ( $\overline{CS}$ ), Serial Clock (SCK) and Serial Data (SI/O) signals. The TC77 meets the SPI and MICROWIRE bus specifications, with the serial interface designed to be compatible with the Microchip PIC® family of microcontrollers.

The  $\overline{CS}$  input is used to select the TC77 when multiple devices are connected to the serial clock and data lines. The  $\overline{CS}$  line is also used to synchronize the data, which is written to, or read from, the device when  $\overline{CS}$  is equal to a logic '0' voltage. The SCK input is disabled when  $\overline{CS}$  is a logic '1'. The falling edge of the  $\overline{CS}$  line initiates communication, while the rising edge of  $\overline{CS}$  completes the communication.

The SCK input is provided by the external microcontroller and is used to synchronize the data on the SI/O line. The Temperature and Manufacturer ID registers are read only while the Configuration register is a read/write register.

Figure 3-2 provides a timing diagram of a read operation of the Temperature register. Communication with the TC77 is initiated when the  $\overline{CS}$  goes to a logic '0'. The Serial I/O signal (SI/O) then transmits the first bit of data. The microcontroller serial I/O bus master clocks the data in on the rising edge of SCK. The falling edge of SCK is then used to clock out the rest of the data. After 14 bits of data (thirteen temperature bits and Bit 2) have been transmitted, the SI/O line is then tri-stated.

Note that  $\overline{CS}$  can be taken to a logic '1' at any time during the data transmission if only a portion of the temperature data information is required. The TC77 will complete the conversion, and the output shift register will be updated, if  $\overline{CS}$  goes to the inactive state while in the middle of a conversion.

Figure 3-3 provides a timing diagram of a multi-byte communication operation consisting of a read of the Temperature Data register, followed by a write to the Configuration register. The first 16 SCK pulses are used to transmit the TC77's temperature data to the microcontroller. The second group of 16 SCK pulses are used to receive the microcontroller command to place the TC77 either in Shutdown or Continuous Temperature Conversion mode. Note that the TC77 is in the Continuous Temperature Conversion mode at power-up.

The data written to the TC77's Configuration register should be either all 0's or all 1's, corresponding to either the Continuous Temperature Conversion or Shutdown mode, respectively. The TC77 is in Shutdown mode when Bits C0 to C7 are all equal to 1's. The TC77 will be in the Continuous Conversion mode if a '0' in any bit location from C0 to C7 is written to the Configuration register.

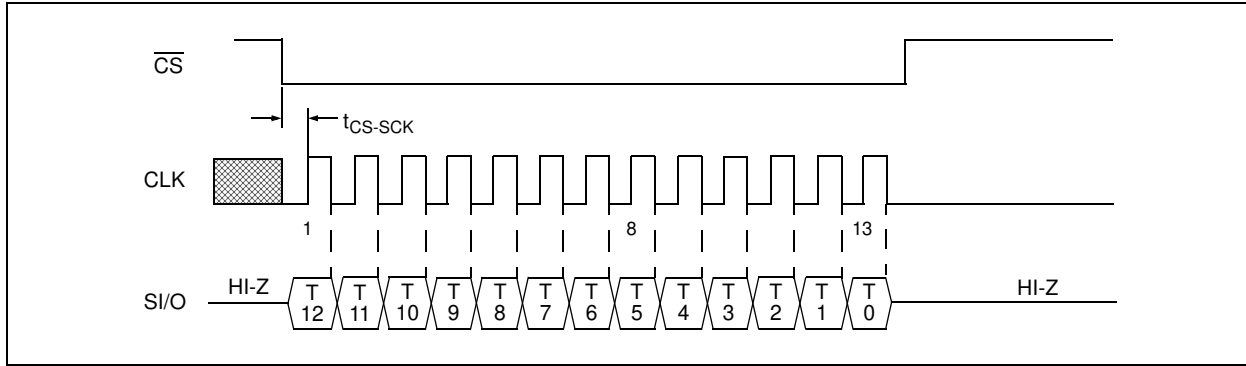

**FIGURE 3-2:** Temperature Read Timing Diagram - (Reading only the first 13 Bits of the Temperature Register).

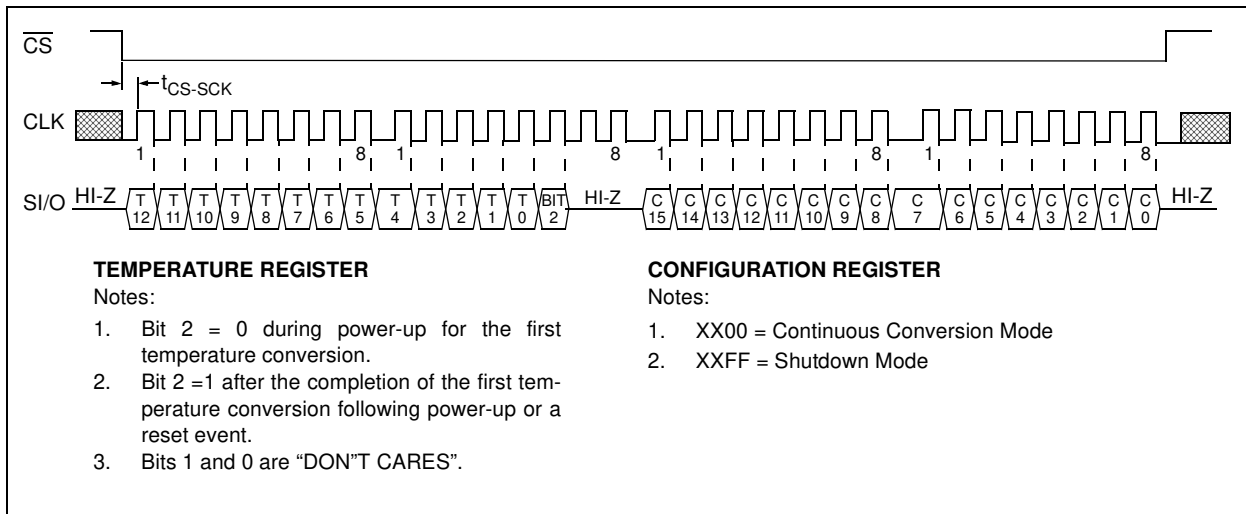

**FIGURE 3-3:** Temperature Read Followed By A Write To The Configuration Register Timing Diagram.

It is recommended that the user write all '0's or all '1's to the Configuration register. While the following codes can be transmitted to the TC77, any other code may put the TC77 into a test mode reserved by Microchip for calibration and production verification tests.

- 00 hex
- 01 hex
- 03 hex
- 07 hex
- 0F hex
- 1F hex
- 3F hex
- 7F hex
- FF hex

The following communication steps can be used to obtain the Manufacturer's ID and put the device into the Continuous Conversion mode. The Manufacturer's ID register is only accessible for a read operation, if the TC77 is in Shutdown mode.

1.  $\overline{CS}$  goes low to initiate the communication cycle.
2. Read 16 bits of temperature data from the Temperature register.
3. Write 16 bits of data (i.e. XXFF hex) to the Configuration register to enter Shutdown mode.
4. Read the 16 bits from the Manufacturer's ID register (C15:C8 = 54 hex) to verify that the sensor is a Microchip device.
5. Write 8 to 16 bits of data (00 or 0000 hex) to enter Continuous Conversion Mode.
6. Return  $\overline{CS}$  high to terminate the communication cycle.

The time between a complete temperature conversion and data transmission is approximately 300 msec.

## 4.0 INTERNAL REGISTER STRUCTURE

The TC77 Internal register structure consists of three registers. The Temperature and Manufacturer's Identification registers are read only, while the Configuration register is write only.

**TABLE 4-1: REGISTERS FOR TC77**

Name	Bit 15	Bit 14	Bit 13	Bit 12	Bit 11	Bit 10	Bit 9	Bit 8	Bit 7	Bit 6	Bit 5	Bit 4	Bit 3	Bit 2	Bit 1	Bit 0	Value at Powerup/Reset
CONFIG	C15	C14	C13	C12	C11	C10	C9	C8	C7	C6	C5	C4	C3	C2	C1	C0	XXXX/XXXX 0000/0000
TEMP	T12	T11	T10	T9	T8	T7	T6	T5	T4	T3	T2	T1	T0	*	x	x	1111/1111 0000/0*XX
M_ID	0	1	0	1	0	1	0	0	0	0	0	0	0	0	x	x	0101/0100 0000/00XX

\* Bit 2 = 0 during power-up; otherwise, bit 2 = 1

### 4.1 Configuration Register (CONFIG)

The Configuration register is write only. This register selects either Shutdown, Continuous Conversion or Test modes:

- C15:C0 = XXXX/XXXX 1111/1111 (Shutdown mode)
- C15:C0 = XXXX/XXXX 0000/0000 (Continuous Conversion mode)
- The TC77 is in Shutdown mode when bits C0 to C7 are all equal to '1's. The TC77 will be in the Continuous Conversion mode if a '0' in any bit location from C0 to C7 is written to the Configuration register. The TC77 is in the Continuous Conversion mode at power-up.

It is recommended that the user write all '0's or all '1's to the Configuration register because other bit codes may put the TC77 in a test mode used for calibration and production verification tests. Section 3.3 lists the Configuration register bit codes that can be written to the TC77 without having the device enter a production test mode.

During Shutdown mode, the serial bus is still active. The current consumption of the TC77 will be less than 1  $\mu$ A during the time between serial communication.

### 4.2 Temperature Register (TEMP)

The Temperature register is read only and holds the temperature conversion data. Bits 0 and 1 are undefined and will be tri-state outputs during a read sequence. Bit 2 is set to a logic '1' after completion of the first temperature conversion following a power-up or reset event. Bit 2 is set to a logic '0' during the time needed to complete the first temperature conversion. Therefore, the status of bit 2 can be monitored to indicate that the TC77 has completed the first temperature conversion. Bits 15:3 contain the 13 bit two's complement data from the temperature conversion.

### 4.3 Manufacturer's ID Register (M\_ID)

The Manufacturer's Identification code is contained in this read only register. The Manufacturer ID register is only available for a read operation when the TC77 is in Shutdown mode. The Manufacturer's ID code is contained in bits 15:8 and is equal to 54 hex to indicate a Microchip device. Bits 1:0 are undefined and will be tri-state outputs during a read sequence, while bits 7:2 are set to '0'.

## 5.0 APPLICATION INFORMATION

The TC77 does not require any additional components in order to measure temperature. However, it is recommended that a decoupling capacitor of 0.1  $\mu\text{F}$  to 1  $\mu\text{F}$  be provided between the  $V_{\text{DD}}$  and  $V_{\text{SS}}$  (Ground) pins (a high frequency ceramic capacitor should be used). It is necessary for the capacitor to be located as close as possible to the integrated circuit (IC) power pins in order to provide effective noise protection to the TC77.

The TC77 measures temperature by monitoring the voltage of a diode located on the IC die. A low-impedance thermal path between the die and the printed circuit board (PCB) is provided by the IC pins of the TC77. Therefore, the TC77 effectively monitors the temperature of the PCB board. The thermal path between the ambient air is not as efficient because the plastic IC housing package functions as a thermal insulator. Thus, the ambient air temperature (assuming that a large temperature gradient exists between the air and PCB) has only a small effect on the temperature measured by the TC77.

A potential for self-heating errors can exist if the TC77 SPI communication lines are heavily loaded. Typically, the self-heating error is negligible because of the relatively small current consumption of the TC77. A temperature accuracy error of approximately 0.5°C will result from self-heating if the SPI communication pins sink/source the maximum current specified for the TC77. Therefore, to maximize the temperature accuracy, the output loading of the SPI signals should be minimized.

## 6.0 PACKAGING INFORMATION

### 6.1 Package Marking Information

5-Lead SOT-23

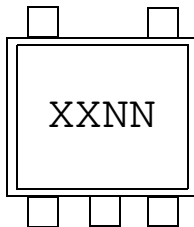

Example:

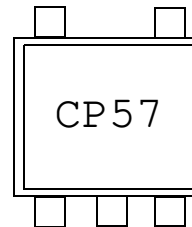

TC77-3.3MCTTR = CN  
TC77-5.0MCTTR = CP

8-Lead SOIC (150 mil)

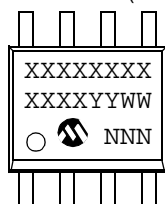

Example:

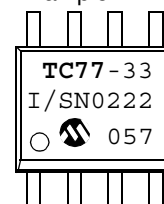

<b>Legend:</b>	XX...X	Customer specific information*
	Y	Year code (last digit of calendar year)
	YY	Year code (last 2 digits of calendar year)
	WW	Week code (week of January 1 is week '01')
	NNN	Alphanumeric traceability code
<b>Note:</b>	In the event the full Microchip part number cannot be marked on one line, it will be carried over to the next line thus limiting the number of available characters for customer specific information.	

\* Standard marking consists of Microchip part number, year code, week code, and traceability code. Please check with your Microchip Sales Office.

# TC77

## 5-Lead Plastic Small Outline Transistor (OT) (SOT23)

**Note:** For the most current package drawings, please see the Microchip Packaging Specification located at <http://www.microchip.com/packaging>

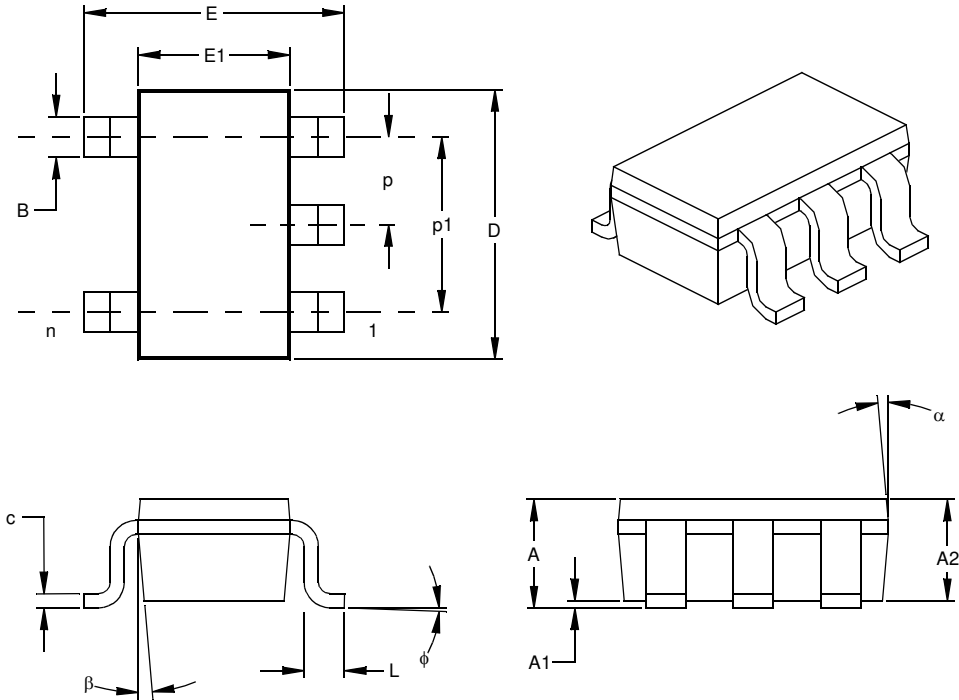

Dimension Limits	Units	INCHES*			MILLIMETERS		
		MIN	NOM	MAX	MIN	NOM	MAX
Number of Pins	n		5			5	
Pitch	p		.038			0.95	
Outside lead pitch (basic)	p1		.075			1.90	
Overall Height	A	.035	.046	.057	0.90	1.18	1.45
Molded Package Thickness	A2	.035	.043	.051	0.90	1.10	1.30
Standoff §	A1	.000	.003	.006	0.00	0.08	0.15
Overall Width	E	.102	.110	.118	2.60	2.80	3.00
Molded Package Width	E1	.059	.064	.069	1.50	1.63	1.75
Overall Length	D	.110	.116	.122	2.80	2.95	3.10
Foot Length	L	.014	.018	.022	0.35	0.45	0.55
Foot Angle	φ	0	5	10	0	5	10
Lead Thickness	c	.004	.006	.008	0.09	0.15	0.20
Lead Width	B	.014	.017	.020	0.35	0.43	0.50
Mold Draft Angle Top	α	0	5	10	0	5	10
Mold Draft Angle Bottom	β	0	5	10	0	5	10

\* Controlling Parameter

§ Significant Characteristic

**Notes:**

Dimensions D and E1 do not include mold flash or protrusions. Mold flash or protrusions shall not exceed .010" (0.254mm) per side.

JEDEC Equivalent: MO-178

Drawing No. C04-091

## 8-Lead Plastic Small Outline (SN) – Narrow, 150 mil (SOIC)

**Note:** For the most current package drawings, please see the Microchip Packaging Specification located at <http://www.microchip.com/packaging>

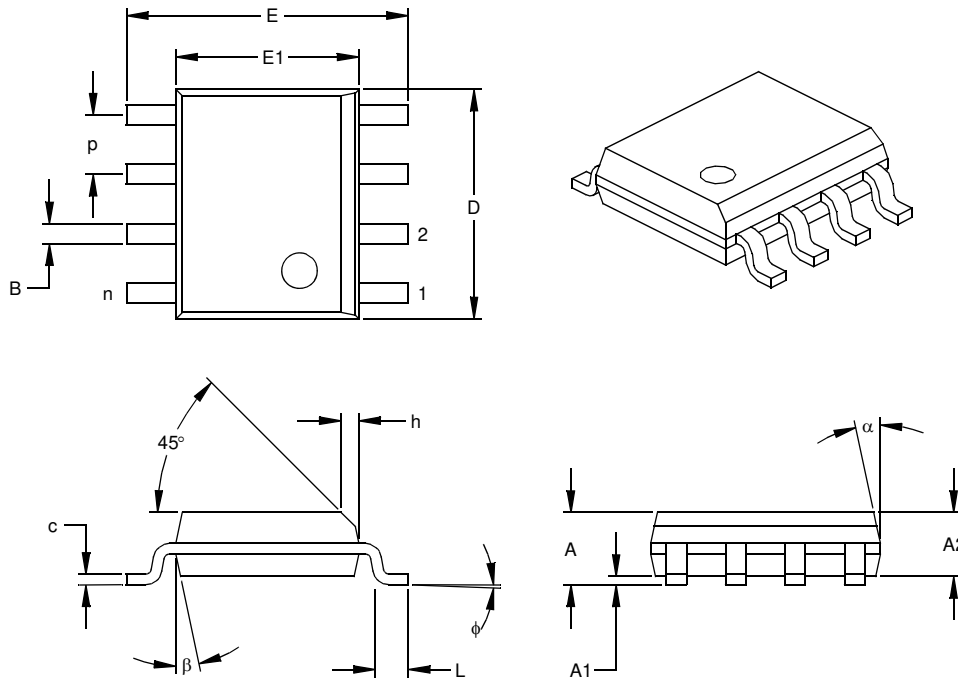

Dimension Limits	Units	INCHES*			MILLIMETERS		
		MIN	NOM	MAX	MIN	NOM	MAX
Number of Pins	n		8			8	
Pitch	p		.050			1.27	
Overall Height	A	.053	.061	.069	1.35	1.55	1.75
Molded Package Thickness	A2	.052	.056	.061	1.32	1.42	1.55
Standoff §	A1	.004	.007	.010	0.10	0.18	0.25
Overall Width	E	.228	.237	.244	5.79	6.02	6.20
Molded Package Width	E1	.146	.154	.157	3.71	3.91	3.99
Overall Length	D	.189	.193	.197	4.80	4.90	5.00
Chamfer Distance	h	.010	.015	.020	0.25	0.38	0.51
Foot Length	L	.019	.025	.030	0.48	0.62	0.76
Foot Angle	φ	0	4	8	0	4	8
Lead Thickness	c	.008	.009	.010	0.20	0.23	0.25
Lead Width	B	.013	.017	.020	0.33	0.42	0.51
Mold Draft Angle Top	α	0	12	15	0	12	15
Mold Draft Angle Bottom	β	0	12	15	0	12	15

\* Controlling Parameter  
 § Significant Characteristic

Notes:  
 Dimensions D and E1 do not include mold flash or protrusions. Mold flash or protrusions shall not exceed .010" (0.254mm) per side.  
 JEDEC Equivalent: MS-012  
 Drawing No. C04-057



# TC77

---

---

NOTES:

---

## THE MICROCHIP WEB SITE

Microchip provides online support via our WWW site at [www.microchip.com](http://www.microchip.com). This web site is used as a means to make files and information easily available to customers. Accessible by using your favorite Internet browser, the web site contains the following information:

- **Product Support** – Data sheets and errata, application notes and sample programs, design resources, user's guides and hardware support documents, latest software releases and archived software
- **General Technical Support** – Frequently Asked Questions (FAQ), technical support requests, online discussion groups, Microchip consultant program member listing
- **Business of Microchip** – Product selector and ordering guides, latest Microchip press releases, listing of seminars and events, listings of Microchip sales offices, distributors and factory representatives

## CUSTOMER CHANGE NOTIFICATION SERVICE

Microchip's customer notification service helps keep customers current on Microchip products. Subscribers will receive e-mail notification whenever there are changes, updates, revisions or errata related to a specified product family or development tool of interest.

To register, access the Microchip web site at [www.microchip.com](http://www.microchip.com). Under "Support", click on "Customer Change Notification" and follow the registration instructions.

## CUSTOMER SUPPORT

Users of Microchip products can receive assistance through several channels:

- Distributor or Representative
- Local Sales Office
- Field Application Engineer (FAE)
- Technical Support

Customers should contact their distributor, representative or field application engineer (FAE) for support. Local sales offices are also available to help customers. A listing of sales offices and locations is included in the back of this document.

**Technical support is available through the web site at: <http://microchip.com/support>**

## READER RESPONSE

It is our intention to provide you with the best documentation possible to ensure successful use of your Microchip product. If you wish to provide your comments on organization, clarity, subject matter, and ways in which our documentation can better serve you, please FAX your comments to the Technical Publications Manager at (480) 792-4150.

Please list the following information, and use this outline to provide us with your comments about this document.

TO: Technical Publications Manager Total Pages Sent \_\_\_\_\_

RE: Reader Response

From: Name \_\_\_\_\_

Company \_\_\_\_\_

Address \_\_\_\_\_

City / State / ZIP / Country \_\_\_\_\_

Telephone: (\_\_\_\_\_) \_\_\_\_\_ - \_\_\_\_\_ FAX: (\_\_\_\_\_) \_\_\_\_\_ - \_\_\_\_\_

Application (optional):

Would you like a reply?  Y  N

Device: TC77

Literature Number: DS20092B

Questions:

1. What are the best features of this document?

\_\_\_\_\_  
\_\_\_\_\_

2. How does this document meet your hardware and software development needs?

\_\_\_\_\_  
\_\_\_\_\_

3. Do you find the organization of this document easy to follow? If not, why?

\_\_\_\_\_  
\_\_\_\_\_

4. What additions to the document do you think would enhance the structure and subject?

\_\_\_\_\_  
\_\_\_\_\_

5. What deletions from the document could be made without affecting the overall usefulness?

\_\_\_\_\_  
\_\_\_\_\_

6. Is there any incorrect or misleading information (what and where)?

\_\_\_\_\_  
\_\_\_\_\_

7. How would you improve this document?

\_\_\_\_\_  
\_\_\_\_\_

## PRODUCT IDENTIFICATION SYSTEM

To order or obtain information, e.g., on pricing or delivery, refer to the factory or the listed sales office.

<u>PART NO.</u>	<u>-X.X</u>	<u>X</u>	<u>XX</u>
Device	Supply Voltage	Temperature Range	Package
Device: TC77: Thermal Sensor with SPI Interface  Supply Voltage: 3.3 = $V_{DD}$ = Accuracy optimized for 3.3V 5.0 = $V_{DD}$ = Accuracy optimized for 5.0V  Temperature Range: M = -55°C to +125°C  Package: CTTR = Plastic Small Outline Transistor (SOT-23), 5-lead (Tape and Reel only) OA = Plastic SOIC, (150 mil Body), 8-lead	<b>Examples:</b> a) TC77-3.3MOA: 3.3V Thermal Sensor in SOIC package. b) TC77-5.0MOA: 5.0V Thermal Sensor in SOIC package. c) TC77-3.3MOATR: 3.3V Thermal Sensor in SOIC package, Tape and Reel. d) TC77-5.0MOATR: 5.0V Thermal Sensor in SOIC package, Tape and Reel. e) TC77-3.3MCTTR: 3.3V Thermal Sensor in SOT-23 package, Tape and Reel. f) TC77-5.0MCTTR: 5.0V Thermal Sensor in SOT-23 package, Tape and Reel.		

## Sales and Support

### Data Sheets

Products supported by a preliminary Data Sheet may have an errata sheet describing minor operational differences and recommended workarounds. To determine if an errata sheet exists for a particular device, please contact one of the following:

1. Your local Microchip sales office
2. The Microchip Worldwide Site ([www.microchip.com](http://www.microchip.com))

Please specify which device, revision of silicon and Data Sheet (include Literature #) you are using.

### New Customer Notification System

Register on our web site ([www.microchip.com/cn](http://www.microchip.com/cn)) to receive the most current information on our products.

# TC77

---

NOTES:

---

**Note the following details of the code protection feature on Microchip devices:**

- Microchip products meet the specification contained in their particular Microchip Data Sheet.
- Microchip believes that its family of products is one of the most secure families of its kind on the market today, when used in the intended manner and under normal conditions.
- There are dishonest and possibly illegal methods used to breach the code protection feature. All of these methods, to our knowledge, require using the Microchip products in a manner outside the operating specifications contained in Microchip's Data Sheets. Most likely, the person doing so is engaged in theft of intellectual property.
- Microchip is willing to work with the customer who is concerned about the integrity of their code.
- Neither Microchip nor any other semiconductor manufacturer can guarantee the security of their code. Code protection does not mean that we are guaranteeing the product as “unbreakable.”

Code protection is constantly evolving. We at Microchip are committed to continuously improving the code protection features of our products. Attempts to break Microchip's code protection feature may be a violation of the Digital Millennium Copyright Act. If such acts allow unauthorized access to your software or other copyrighted work, you may have a right to sue for relief under that Act.

---

Information contained in this publication regarding device applications and the like is provided only for your convenience and may be superseded by updates. It is your responsibility to ensure that your application meets with your specifications. MICROCHIP MAKES NO REPRESENTATIONS OR WARRANTIES OF ANY KIND WHETHER EXPRESS OR IMPLIED, WRITTEN OR ORAL, STATUTORY OR OTHERWISE, RELATED TO THE INFORMATION, INCLUDING BUT NOT LIMITED TO ITS CONDITION, QUALITY, PERFORMANCE, MERCHANTABILITY OR FITNESS FOR PURPOSE. Microchip disclaims all liability arising from this information and its use. Use of Microchip devices in life support and/or safety applications is entirely at the buyer's risk, and the buyer agrees to defend, indemnify and hold harmless Microchip from any and all damages, claims, suits, or expenses resulting from such use. No licenses are conveyed, implicitly or otherwise, under any Microchip intellectual property rights.

#### **Trademarks**

The Microchip name and logo, the Microchip logo, dsPIC, FlashFlex, KEELOQ, KEELOQ logo, MPLAB, PIC, PICmicro, PICSTART, PIC<sup>32</sup> logo, rPIC, SST, SST Logo, SuperFlash and UNI/O are registered trademarks of Microchip Technology Incorporated in the U.S.A. and other countries.

FilterLab, Hampshire, HI-TECH C, Linear Active Thermistor, MTP, SEEVAL and The Embedded Control Solutions Company are registered trademarks of Microchip Technology Incorporated in the U.S.A.

Silicon Storage Technology is a registered trademark of Microchip Technology Inc. in other countries.

Analog-for-the-Digital Age, Application Maestro, BodyCom, chipKIT, chipKIT logo, CodeGuard, dsPICDEM, dsPICDEM.net, dsPICworks, dsSPEAK, ECAN, ECONOMONITOR, FanSense, HI-TIDE, In-Circuit Serial Programming, ICSP, Mindi, MiWi, MPASM, MPF, MPLAB Certified logo, MPLIB, MPLINK, mTouch, Omniclient Code Generation, PICC, PICC-18, PICDEM, PICDEM.net, PICkit, PICtail, REAL ICE, rLAB, Select Mode, SQI, Serial Quad I/O, Total Endurance, TSHARC, UniWinDriver, WiperLock, ZENA and Z-Scale are trademarks of Microchip Technology Incorporated in the U.S.A. and other countries.

SQTP is a service mark of Microchip Technology Incorporated in the U.S.A.

GestIC and ULPP are registered trademarks of Microchip Technology Germany II GmbH & Co. & KG, a subsidiary of Microchip Technology Inc., in other countries.

All other trademarks mentioned herein are property of their respective companies.

© 2002-2012, Microchip Technology Incorporated, Printed in the U.S.A., All Rights Reserved.

 Printed on recycled paper.

ISBN: 9781620767511

**QUALITY MANAGEMENT SYSTEM**  
**CERTIFIED BY DNV**  
**== ISO/TS 16949 ==**

*Microchip received ISO/TS-16949:2009 certification for its worldwide headquarters, design and wafer fabrication facilities in Chandler and Tempe, Arizona; Gresham, Oregon and design centers in California and India. The Company's quality system processes and procedures are for its PIC<sup>®</sup> MCUs and dsPIC<sup>®</sup> DSCs, KEELOQ<sup>®</sup> code hopping devices, Serial EEPROMs, microperipherals, nonvolatile memory and analog products. In addition, Microchip's quality system for the design and manufacture of development systems is ISO 9001:2000 certified.*



# MICROCHIP

## Worldwide Sales and Service

### AMERICAS

**Corporate Office**  
2355 West Chandler Blvd.  
Chandler, AZ 85224-6199  
Tel: 480-792-7200  
Fax: 480-792-7277  
Technical Support:  
<http://www.microchip.com/support>  
Web Address:  
[www.microchip.com](http://www.microchip.com)

**Atlanta**  
Duluth, GA  
Tel: 678-957-9614  
Fax: 678-957-1455

**Boston**  
Westborough, MA  
Tel: 774-760-0087  
Fax: 774-760-0088

**Chicago**  
Itasca, IL  
Tel: 630-285-0071  
Fax: 630-285-0075

**Cleveland**  
Independence, OH  
Tel: 216-447-0464  
Fax: 216-447-0643

**Dallas**  
Addison, TX  
Tel: 972-818-7423  
Fax: 972-818-2924

**Detroit**  
Farmington Hills, MI  
Tel: 248-538-2250  
Fax: 248-538-2260

**Indianapolis**  
Noblesville, IN  
Tel: 317-773-8323  
Fax: 317-773-5453

**Los Angeles**  
Mission Viejo, CA  
Tel: 949-462-9523  
Fax: 949-462-9608

**Santa Clara**  
Santa Clara, CA  
Tel: 408-961-6444  
Fax: 408-961-6445

**Toronto**  
Mississauga, Ontario,  
Canada  
Tel: 905-673-0699  
Fax: 905-673-6509

### ASIA/PACIFIC

**Asia Pacific Office**  
Suites 3707-14, 37th Floor  
Tower 6, The Gateway  
Harbour City, Kowloon  
Hong Kong  
Tel: 852-2401-1200  
Fax: 852-2401-3431

**Australia - Sydney**  
Tel: 61-2-9868-6733  
Fax: 61-2-9868-6755

**China - Beijing**  
Tel: 86-10-8569-7000  
Fax: 86-10-8528-2104

**China - Chengdu**  
Tel: 86-28-8665-5511  
Fax: 86-28-8665-7889

**China - Chongqing**  
Tel: 86-23-8980-9588  
Fax: 86-23-8980-9500

**China - Hangzhou**  
Tel: 86-571-2819-3187  
Fax: 86-571-2819-3189

**China - Hong Kong SAR**  
Tel: 852-2401-1200  
Fax: 852-2401-3431

**China - Nanjing**  
Tel: 86-25-8473-2460  
Fax: 86-25-8473-2470

**China - Qingdao**  
Tel: 86-532-8502-7355  
Fax: 86-532-8502-7205

**China - Shanghai**  
Tel: 86-21-5407-5533  
Fax: 86-21-5407-5066

**China - Shenyang**  
Tel: 86-24-2334-2829  
Fax: 86-24-2334-2393

**China - Shenzhen**  
Tel: 86-755-8203-2660  
Fax: 86-755-8203-1760

**China - Wuhan**  
Tel: 86-27-5980-5300  
Fax: 86-27-5980-5118

**China - Xian**  
Tel: 86-29-8833-7252  
Fax: 86-29-8833-7256

**China - Xiamen**  
Tel: 86-592-2388138  
Fax: 86-592-2388130

**China - Zhuhai**  
Tel: 86-756-3210040  
Fax: 86-756-3210049

### ASIA/PACIFIC

**India - Bangalore**  
Tel: 91-80-3090-4444  
Fax: 91-80-3090-4123

**India - New Delhi**  
Tel: 91-11-4160-8631  
Fax: 91-11-4160-8632

**India - Pune**  
Tel: 91-20-2566-1512  
Fax: 91-20-2566-1513

**Japan - Osaka**  
Tel: 81-66-152-7160  
Fax: 81-66-152-9310

**Japan - Yokohama**  
Tel: 81-45-471-6166  
Fax: 81-45-471-6122

**Korea - Daegu**  
Tel: 82-53-744-4301  
Fax: 82-53-744-4302

**Korea - Seoul**  
Tel: 82-2-554-7200  
Fax: 82-2-558-5932 or  
82-2-558-5934

**Malaysia - Kuala Lumpur**  
Tel: 60-3-6201-9857  
Fax: 60-3-6201-9859

**Malaysia - Penang**  
Tel: 60-4-227-8870  
Fax: 60-4-227-4068

**Philippines - Manila**  
Tel: 63-2-634-9065  
Fax: 63-2-634-9069

**Singapore**  
Tel: 65-6334-8870  
Fax: 65-6334-8850

**Taiwan - Hsin Chu**  
Tel: 886-3-5778-366  
Fax: 886-3-5770-955

**Taiwan - Kaohsiung**  
Tel: 886-7-213-7828  
Fax: 886-7-330-9305

**Taiwan - Taipei**  
Tel: 886-2-2508-8600  
Fax: 886-2-2508-0102

**Thailand - Bangkok**  
Tel: 66-2-694-1351  
Fax: 66-2-694-1350

### EUROPE

**Austria - Wels**  
Tel: 43-7242-2244-39  
Fax: 43-7242-2244-393

**Denmark - Copenhagen**  
Tel: 45-4450-2828  
Fax: 45-4485-2829

**France - Paris**  
Tel: 33-1-69-53-63-20  
Fax: 33-1-69-30-90-79

**Germany - Munich**  
Tel: 49-89-627-144-0  
Fax: 49-89-627-144-44

**Italy - Milan**  
Tel: 39-0331-742611  
Fax: 39-0331-466781

**Netherlands - Drunen**  
Tel: 31-416-690399  
Fax: 31-416-690340

**Spain - Madrid**  
Tel: 34-91-708-08-90  
Fax: 34-91-708-08-91

**UK - Wokingham**  
Tel: 44-118-921-5869  
Fax: 44-118-921-5820

10/26/12