



Chipsmall Limited consists of a professional team with an average of over 10 year of expertise in the distribution of electronic components. Based in Hongkong, we have already established firm and mutual-benefit business relationships with customers from,Europe,America and south Asia,supplying obsolete and hard-to-find components to meet their specific needs.

With the principle of “Quality Parts,Customers Priority,Honest Operation,and Considerate Service”,our business mainly focus on the distribution of electronic components. Line cards we deal with include Microchip,ALPS,ROHM,Xilinx,Pulse,ON,Everlight and Freescale. Main products comprise IC,Modules,Potentiometer,IC Socket,Relay,Connector.Our parts cover such applications as commercial,industrial, and automotives areas.

We are looking forward to setting up business relationship with you and hope to provide you with the best service and solution. Let us make a better world for our industry!



Contact us

Tel: +86-755-8981 8866 Fax: +86-755-8427 6832

Email & Skype: info@chipsmall.com Web: www.chipsmall.com

Address: A1208, Overseas Decoration Building, #122 Zhenhua RD., Futian, Shenzhen, China



40 W + 40 W stereo amplifier with mute and standby

Datasheet – production data

Features

- Wide supply voltage range (up to ± 33 V)
- Split supply
- High output power
- 40 W + 40 W into 8Ω with $V_S = \pm 26$ V and THD = 10%
- No “pop” at turn on/off
- Mute (“pop”-free)
- Standby feature (low I_Q)
- Short-circuit protection
- Thermal overload protection

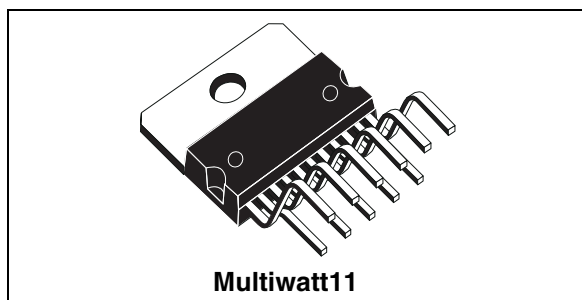

Description

The TDA7292 is a class-AB dual audio power amplifier assembled in a Multiwatt package.

It has been specifically designed for high-quality sound applications such as hi-fi music centers and stereo TV sets.

Table 1. Device summary

Order code	Operating temp. range	Package	Packaging
TDA7292	0° to 70° C	Multiwatt11	Tube

Figure 1. Applications circuit

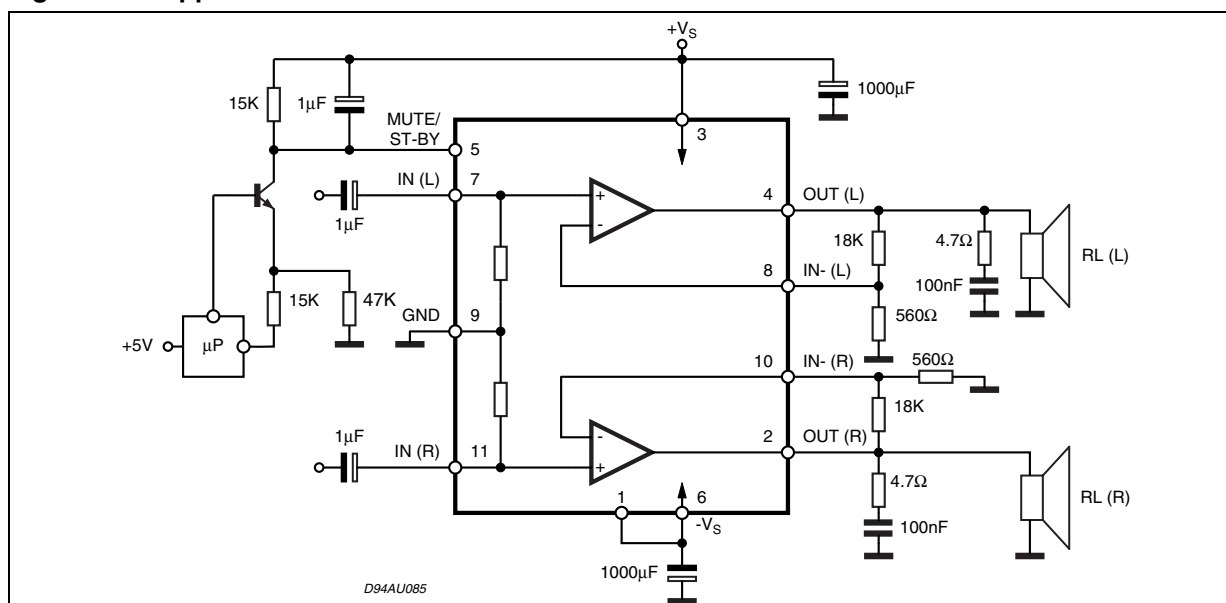

Contents

1	Pin description	5
2	Electrical specifications	6
2.1	Absolute maximum ratings	6
2.2	Thermal data	6
2.3	Electrical specifications	6
3	Characterization curves	8
4	Mute and standby modes	13
5	Applications information	14
5.1	Applications with dual supply	14
5.2	Applications with single supply	17
6	Package mechanical data	20
7	Revision history	21

List of tables

Table 1.	Device summary	1
Table 2.	Absolute maximum ratings	6
Table 3.	Thermal data	6
Table 4.	Electrical specifications	6
Table 5.	Mute and standby thresholds on pin 5	13
Table 6.	Recommended values	15
Table 7.	Document revision history	21

List of figures

Figure 1.	Applications circuit	1
Figure 2.	Pin connections (top view)	5
Figure 3.	Quiescent current vs. supply voltage	8
Figure 4.	Frequency response	8
Figure 5.	Output power vs. supply voltage	9
Figure 6.	Output power vs. supply voltage	9
Figure 7.	Output power vs. supply voltage	9
Figure 8.	THD vs. output power	10
Figure 9.	THD vs. output power	10
Figure 10.	THD vs. output power	10
Figure 11.	Quiescent current vs. voltage on pin 5	11
Figure 12.	Attenuation vs. voltage on pin 5	11
Figure 13.	Crosstalk vs. frequency	11
Figure 14.	Power dissipation vs. output power	12
Figure 15.	Power dissipation vs. output power	12
Figure 16.	Power dissipation vs. output power	12
Figure 17.	Mute and standby thresholds on pin 5	13
Figure 18.	Test and applications circuit (dual supply)	14
Figure 19.	PCB layout, solder side	16
Figure 20.	PCB layout, component side	16
Figure 21.	PCB component placement	17
Figure 22.	Typical applications circuit (single supply)	17
Figure 23.	PCB layout, solder side	18
Figure 24.	PCB layout, component side	18
Figure 25.	PCB component placement	19
Figure 26.	Multiwatt11 outline drawing and dimensions	20

1 Pin description

Figure 2. Pin connections (top view)

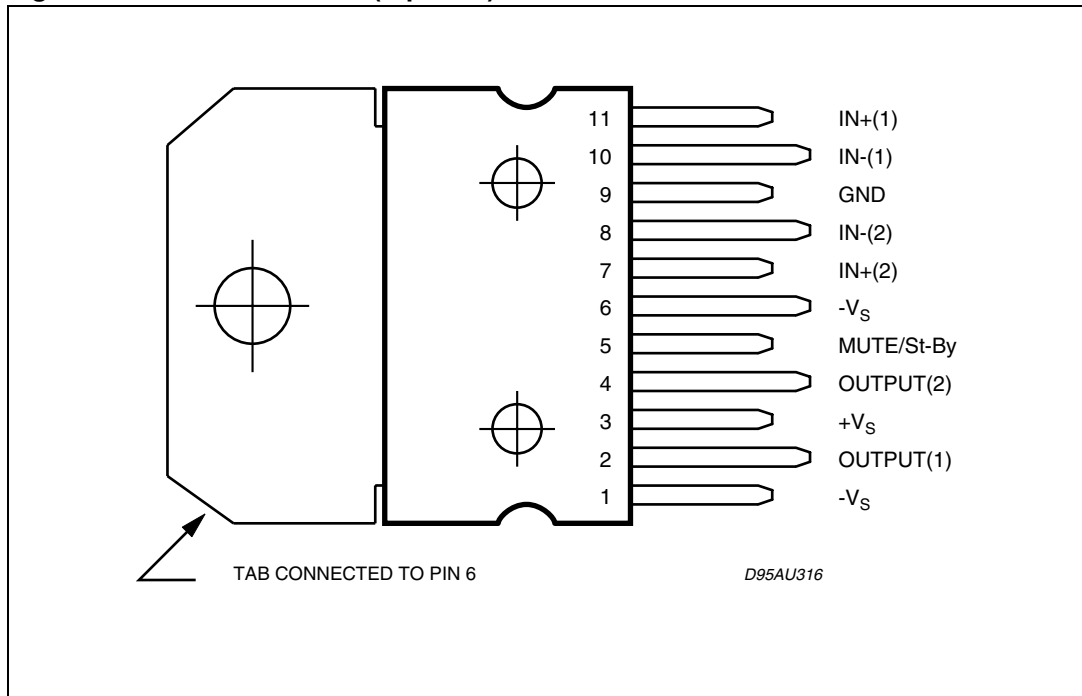

2 Electrical specifications

2.1 Absolute maximum ratings

Table 2. Absolute maximum ratings

Symbol	Parameter	Value	Unit
V_S	DC supply voltage	± 35	V
I_O	Output peak current (internally limited)	5	A
P_{tot}	Power dissipation $T_{case} = 70^\circ\text{C}$	40	W
T_{op}	Operating temperature	-20 to 85	$^\circ\text{C}$
T_j	Junction temperature	-40 to 150	$^\circ\text{C}$
T_{stg}	Storage temperature	-40 to 150	$^\circ\text{C}$

2.2 Thermal data

Table 3. Thermal data

Symbol	Parameter	Min	Typ	Max	Unit
$R_{th\ j-case}$	Thermal resistance, junction to case	-	1.5	-	$^\circ\text{C}/\text{W}$

2.3 Electrical specifications

Unless otherwise stated, the results in [Table 4](#) below are given for the conditions: $V_S = \pm 26\text{ V}$, R_L (load) = 8 Ω , R_S (source) = 50 Ω , $f = 1\text{ kHz}$, $G_V = 30\text{ dB}$, and $T_{amb} = 25^\circ\text{ C}$. See also the test circuit in [Figure 18 on page 14](#).

Table 4. Electrical specifications

Symbol	Parameter	Condition	Min	Typ	Max	Unit
V_S	Supply voltage range	-	± 8	-	± 33	V
I_q	Total quiescent current	-	-	50	130	mA
V_{OS}	Output offset voltage	-	-20	-	20	mV
I_b	Non-inverting input bias current	-	-	500	-	nA
P_o	Output power	THD = 10%: $R_L = 8\ \Omega$, $V_S = \pm 26\text{ V}$ $R_L = 4\ \Omega$, $V_S = \pm 18\text{ V}$	-	40 31	-	W
		THD = 1%: $R_L = 8\ \Omega$, $V_S = \pm 26\text{ V}$ $R_L = 4\ \Omega$, $V_S = \pm 18\text{ V}$	-	30 24	-	
I_{Peak}	Peak output current	Internally limited	-	5	-	A
THD	Total harmonic distortion	$P_o = 1\text{ W}$	-	0.02	-	%

Table 4. Electrical specifications (continued)

Symbol	Parameter	Condition	Min	Typ	Max	Unit
C_T	Crosstalk	$f = 1 \text{ kHz}$	-	70	-	dB
SR	Slew rate	-	-	11	-	V/ms
G_{OL}	Open-loop gain	-	-	80	-	dB
eN	Total input noise	$f = 20 \text{ Hz to } 22 \text{ kHz}$	-	4	-	μV
R_i	Input resistance	-	-	20	-	$\text{k}\Omega$
SVRR	Supply voltage rejection ratio	-	-	75	-	dB
T_j	Junction temperature at thermal shut-down	-	-	145	-	$^{\circ}\text{C}$
Mute mode (see also Table 5 on page 13)						
V_{T_MUTE}	Mute/play threshold	-	-7	-6	-5	V
A_{MUTE}	Mute attenuation	-	-	75	-	dB
Standby mode (see also Table 5 on page 13)						
V_{T_STBY}	Standby/mute threshold	-	-3.5	-2.5	-1.5	V
A_{STBY}	Standby attenuation	-	-	110	-	dB
I_{q_STBY}	Quiescent current in standby	-	-	8	-	mA

3 Characterization curves

Figure 3. Quiescent current vs. supply voltage

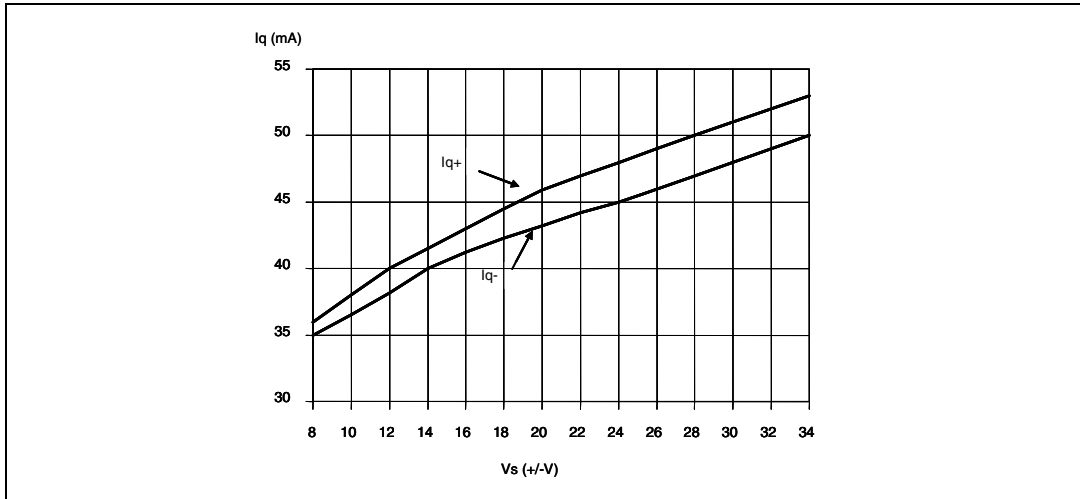

Figure 4. Frequency response

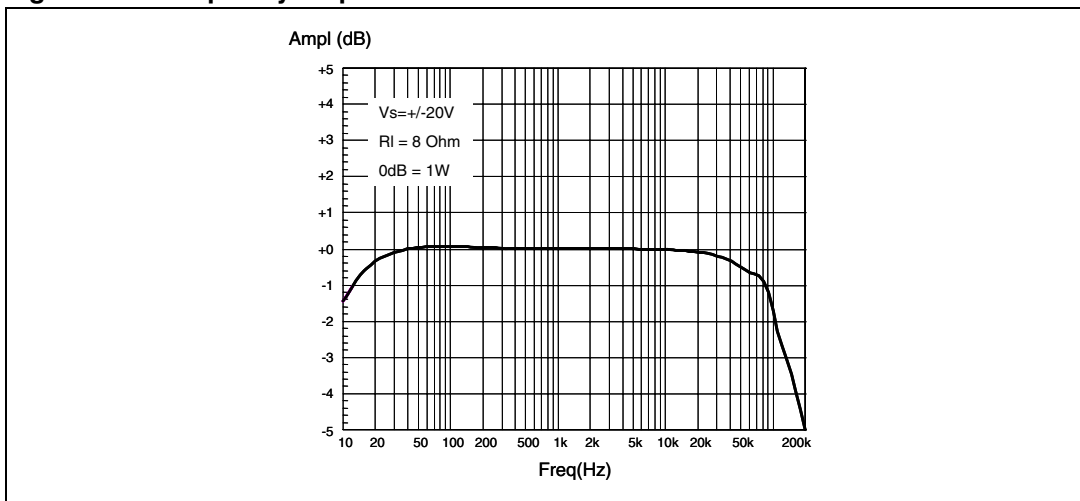

Figure 5. Output power vs. supply voltage

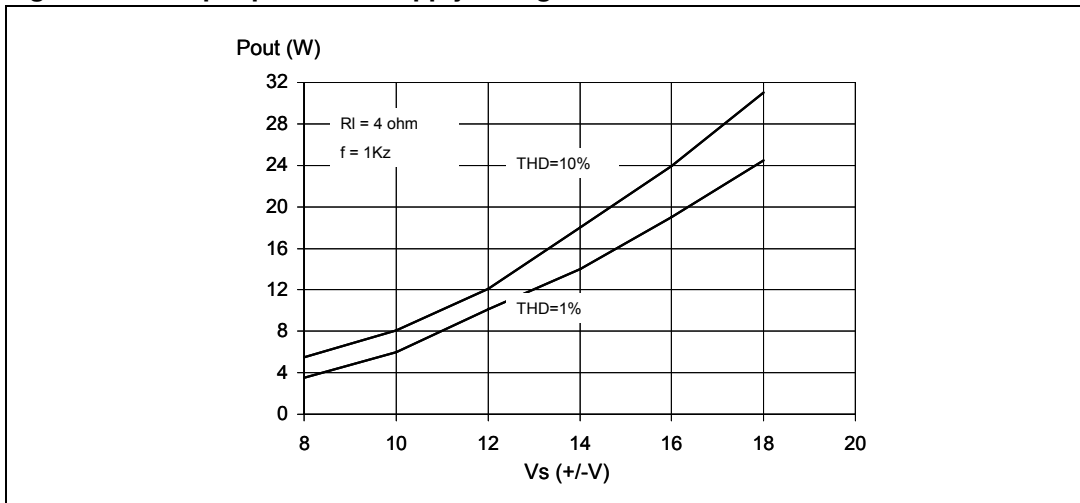

Figure 6. Output power vs. supply voltage

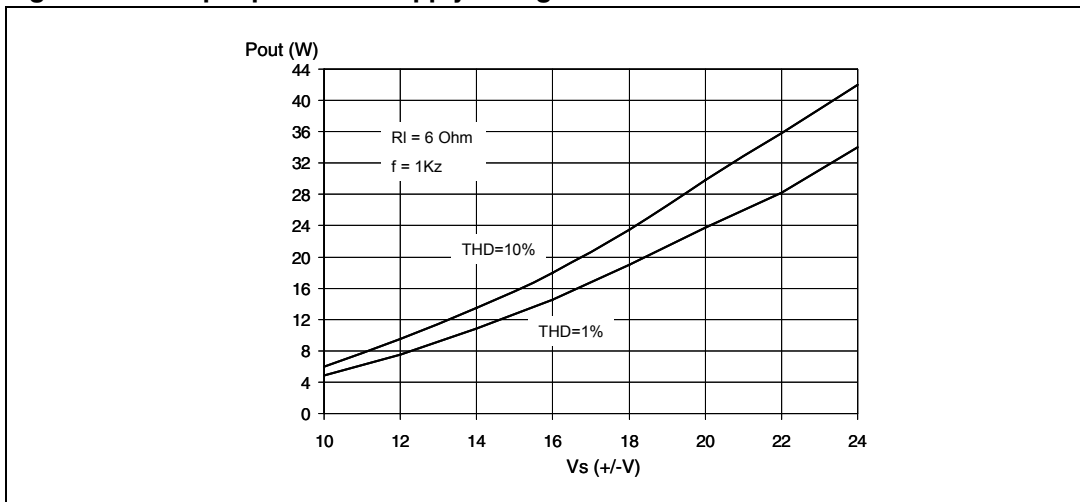

Figure 7. Output power vs. supply voltage

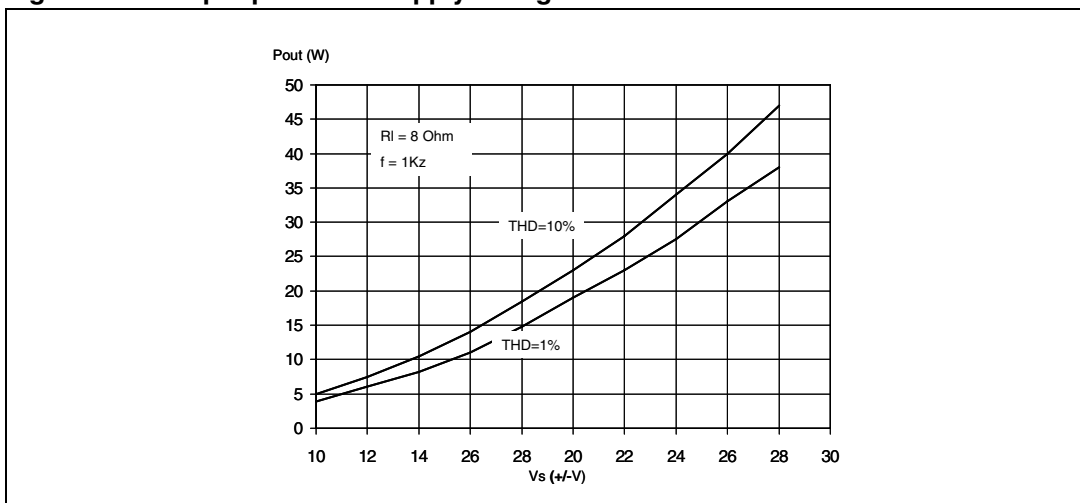

Figure 8. THD vs. output power

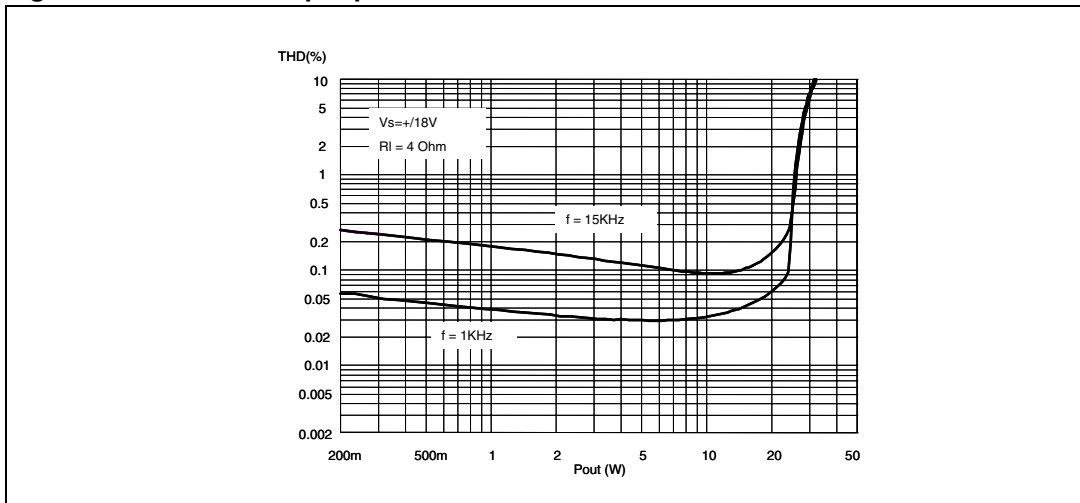

Figure 9. THD vs. output power

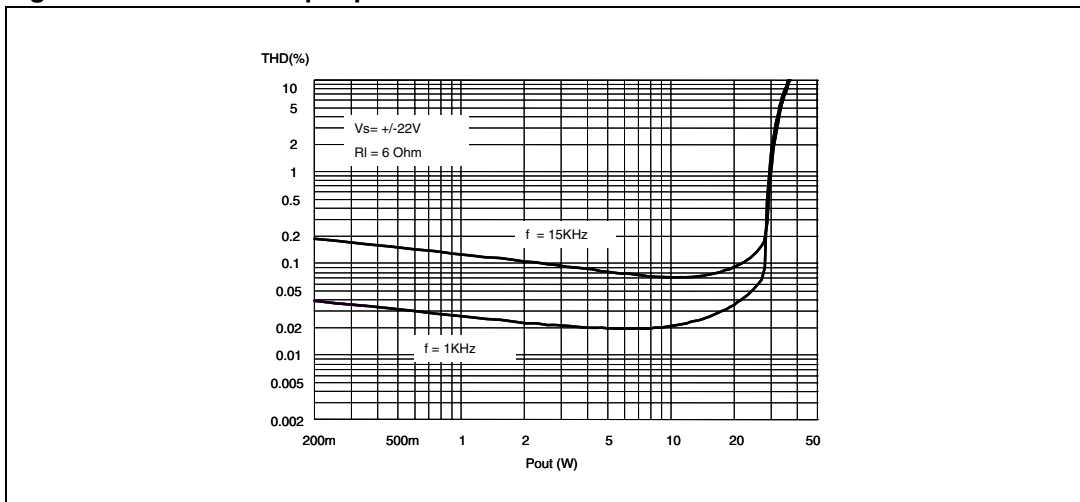

Figure 10. THD vs. output power

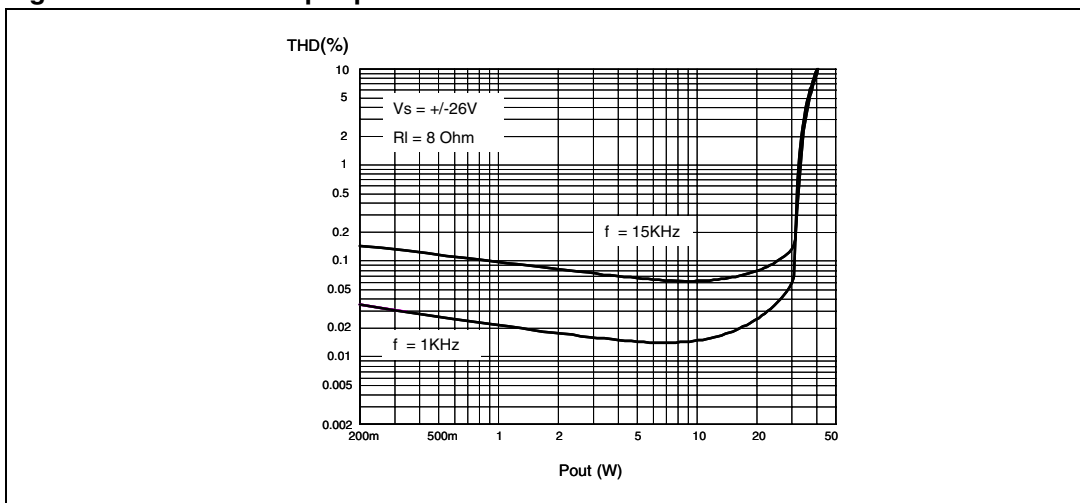

Figure 11. Quiescent current vs. voltage on pin 5

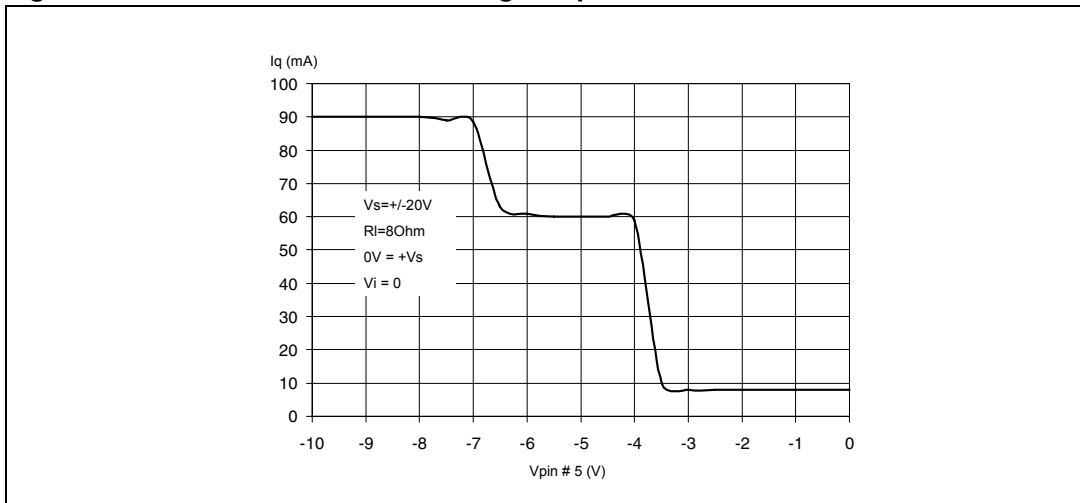

Figure 12. Attenuation vs. voltage on pin 5

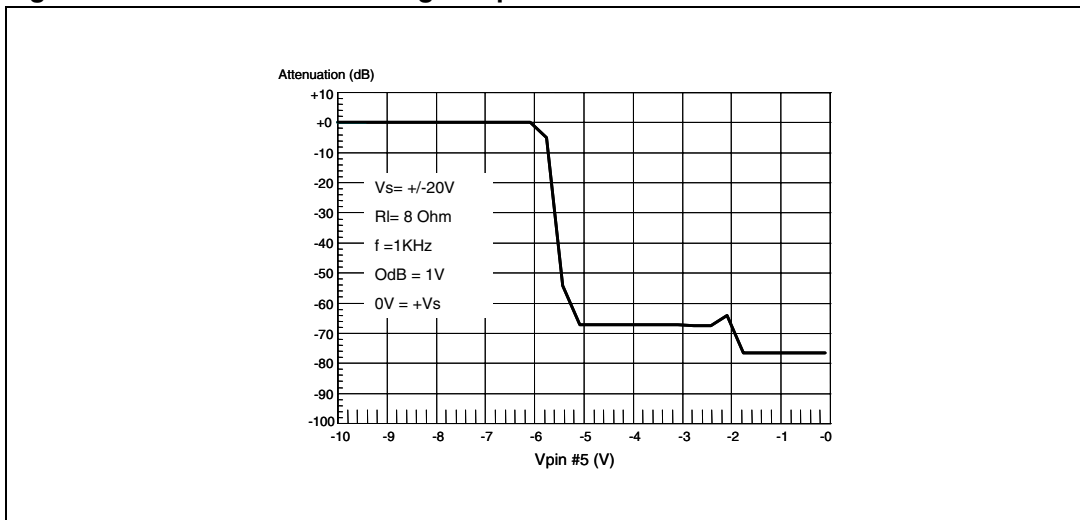

Figure 13. Crosstalk vs. frequency

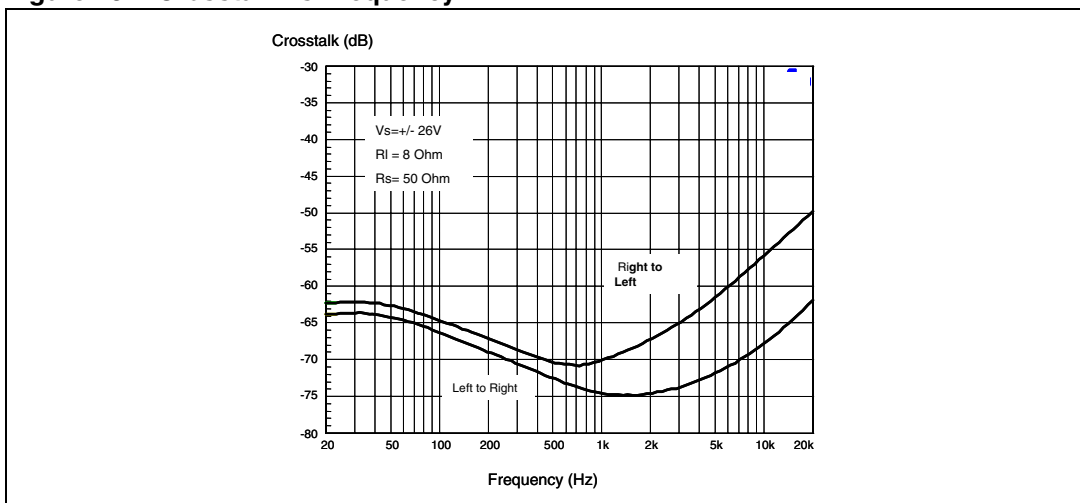

Figure 14. Power dissipation vs. output power

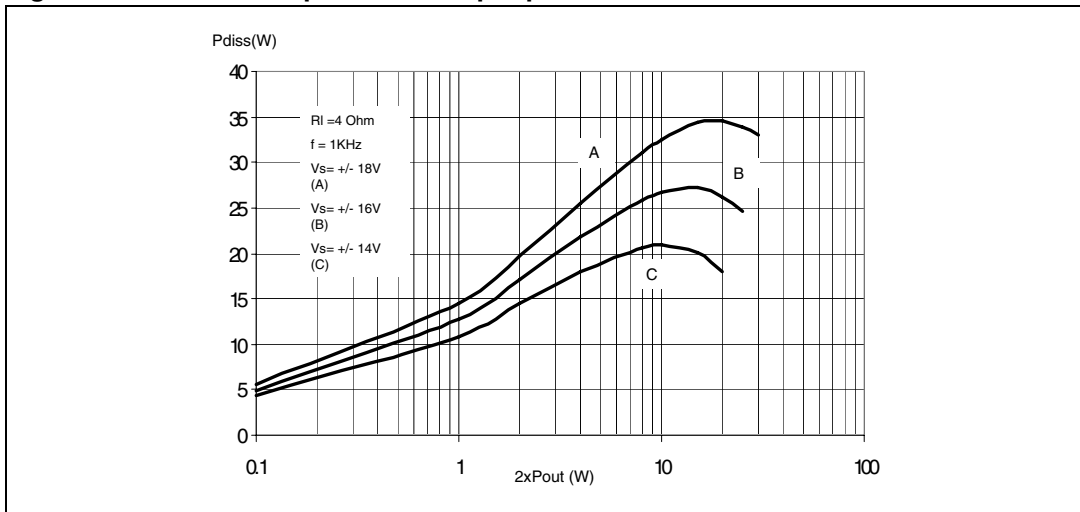

Figure 15. Power dissipation vs. output power

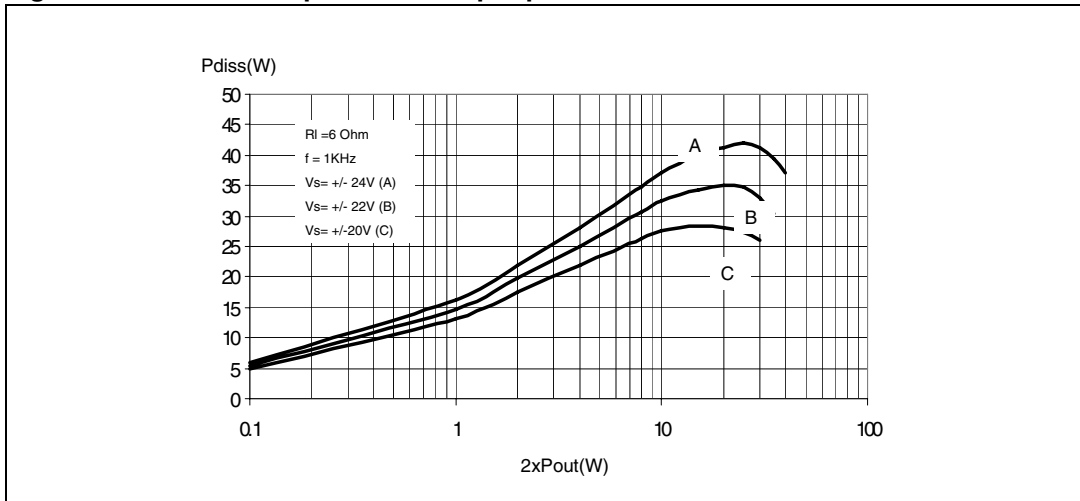
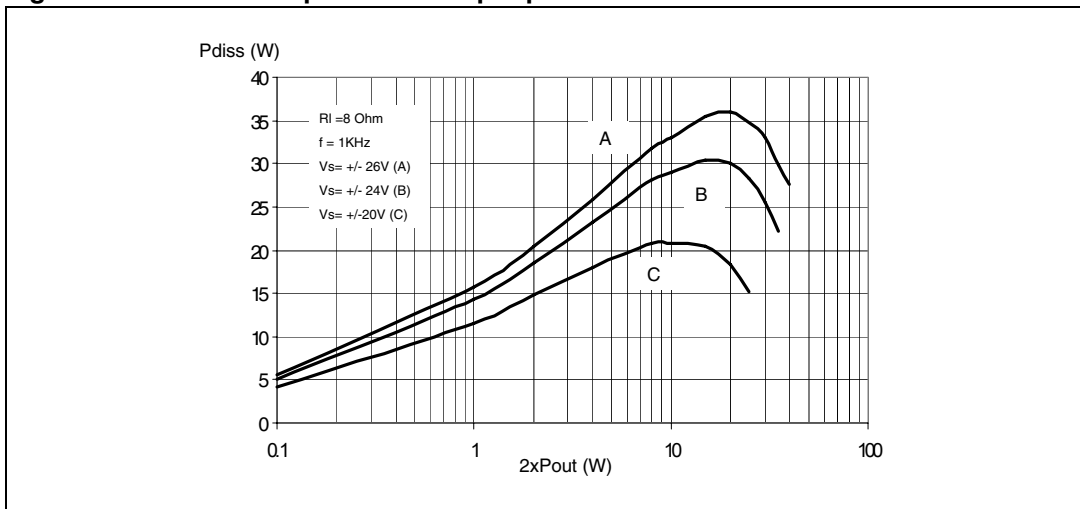

Figure 16. Power dissipation vs. output power



4 Mute and standby modes

Pin 5 (MUTE/STANDBY) controls the amplifier status by two different thresholds referenced to $+V_S$ as given in [Table 5](#) below. See also [Table 4: Electrical specifications on page 6](#).

Table 5. Mute and standby thresholds on pin 5

Nominal voltage on pin 5, V_{PIN5}	Mode	Remarks
$> +V_S - 2.5\text{ V}$	Standby	Output stages turned off
$> +V_S - 6.0\text{ V}, < +V_S - 2.5\text{ V}$	Mute	Output stages turned on, amplifiers muted
$< +V_S - 6.0\text{ V}$	Play	Amplifiers active

Figure 17. Mute and standby thresholds on pin 5

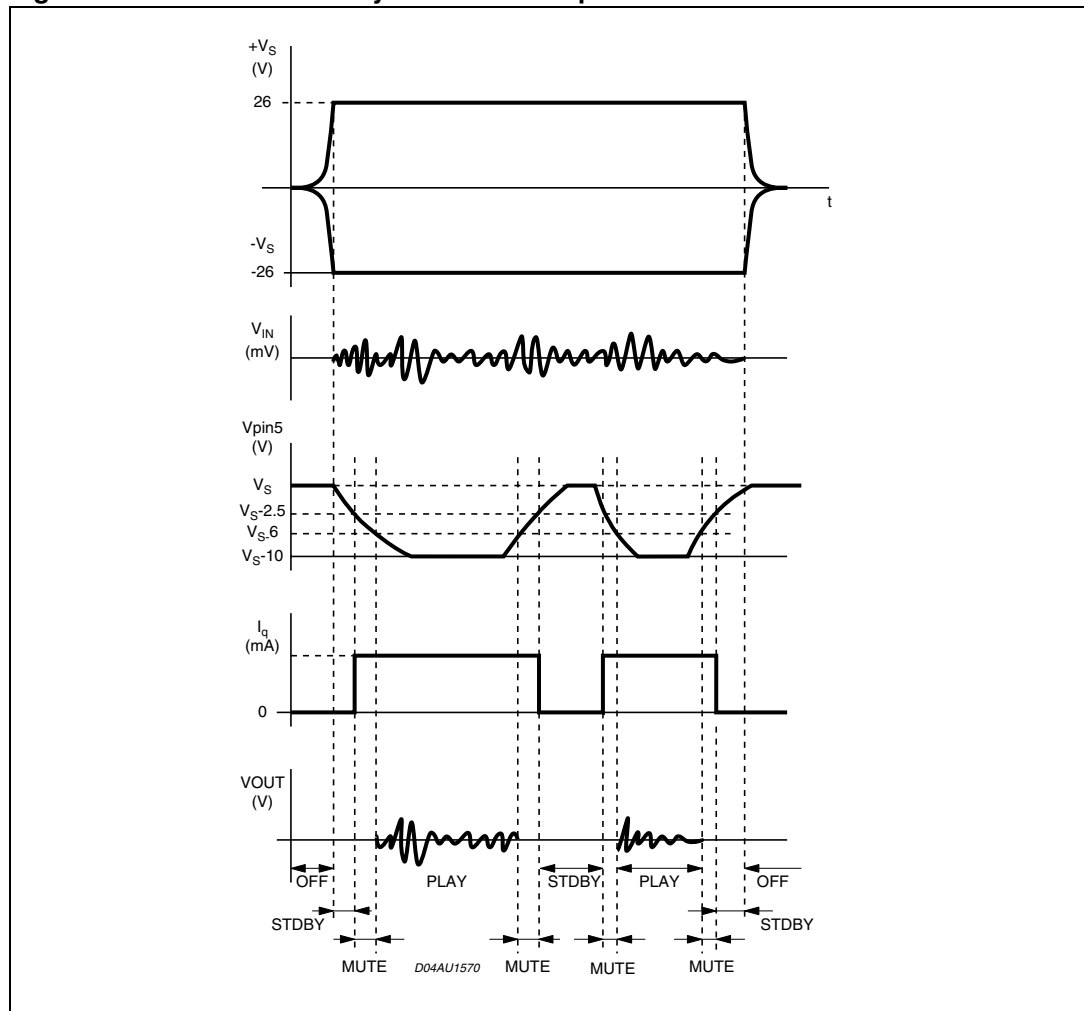

5 Applications information

Warning: SOA protection:

If the TDA7292 is operated without a load connected to the output terminals, the SOA protection circuit could be activated when a high amplitude and high frequency signal is applied to the input.

The frequency and amplitude of the signal able to trigger the protection is a function also of the supply voltage level used. If the above mentioned condition is possible when the speakers are not connected, it is recommended to connect the input to ground or add a dummy resistive load. For example, a 1-kΩ / 1-W resistor can be used at Vcc = ±26 V. If a lower supply voltage is used, the resistor value must be decreased accordingly.

5.1 Applications with dual supply

Figure 18. Test and applications circuit (dual supply)

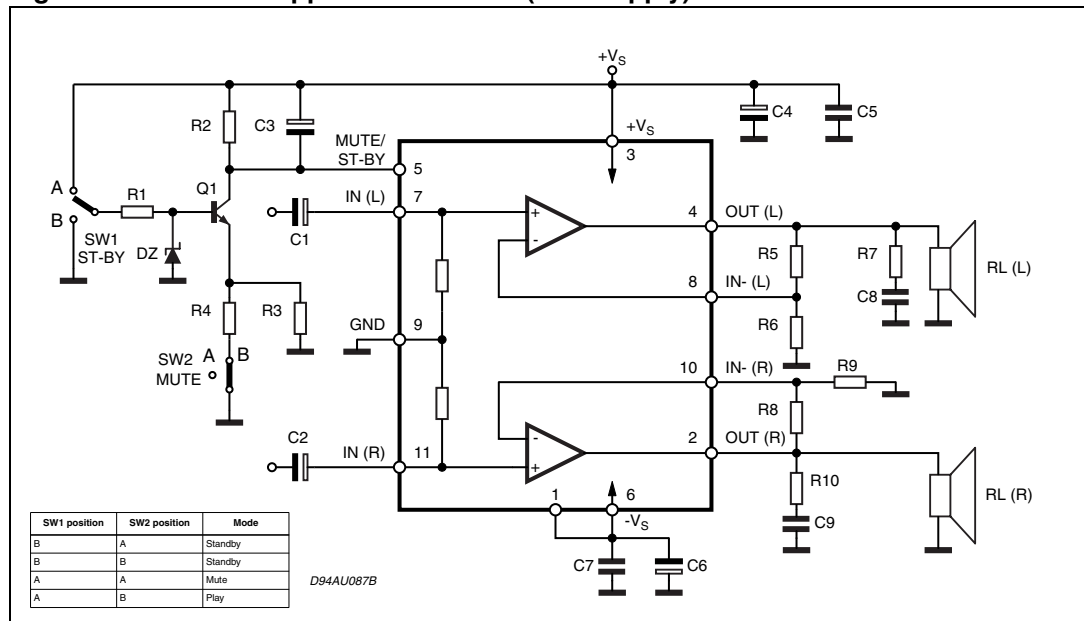

Table 6. Recommended values

Component	Recommended value	Purpose	Larger than recommended value	Smaller than recommended value
R1	10 k Ω	Mute circuit	Decrease in DZ biasing current	-
R2	15 k Ω	Mute circuit	V _{PIN5} shifted downwards	V _{PIN5} shifted upwards
R3	47 k Ω	Mute circuit	V _{PIN5} shifted upwards	V _{PIN5} shifted downwards
R4	15 k Ω	Mute circuit	V _{PIN5} shifted upwards	V _{PIN5} shifted downwards
R5, R8	18 k Ω	Closed-loop gain setting ⁽¹⁾	Increase in gain	-
R6, R9	560 Ω		Decrease in gain	-
R7, R10	4.7 Ω	Frequency stability	Danger of oscillation	Danger of oscillation
C1, C2	1 μ F	Input AC coupling	-	Higher low-frequency cutoff
C3	1 μ F	Standby/mute time constant	Larger on/off time	Smaller on/off time
C4, C6	1000 μ F	Supply voltage decoupling	-	Danger of oscillation
C5, C7	0.1 μ F	Supply voltage decoupling	-	Danger of oscillation
C8, C9	0.1 μ F	Frequency stability	-	-
Dz	5.1 V	Mute circuit	-	-
Q1	BC107	Mute circuit	-	-

1. Closed-loop gain must be >29 dB

Note: The PCB layout shown in [Figure 19](#), [Figure 20](#), and [Figure 21](#) is common to the pin-to-pin compatible devices TDA7269A, TDA7265 and TDA7265B.

Figure 19. PCB layout, solder side

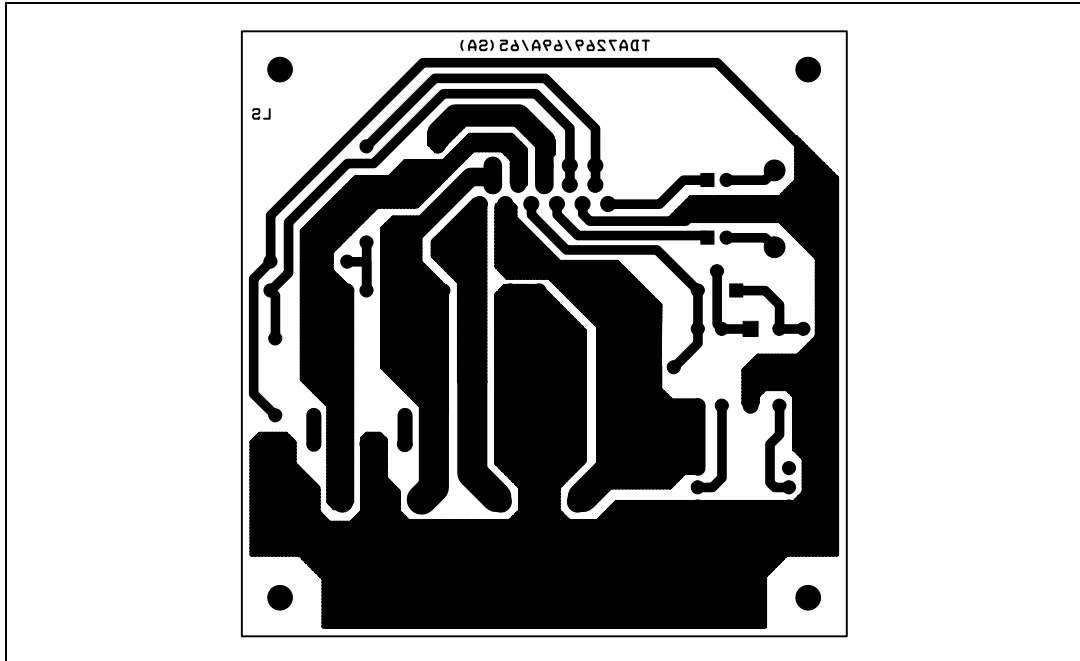

Figure 20. PCB layout, component side

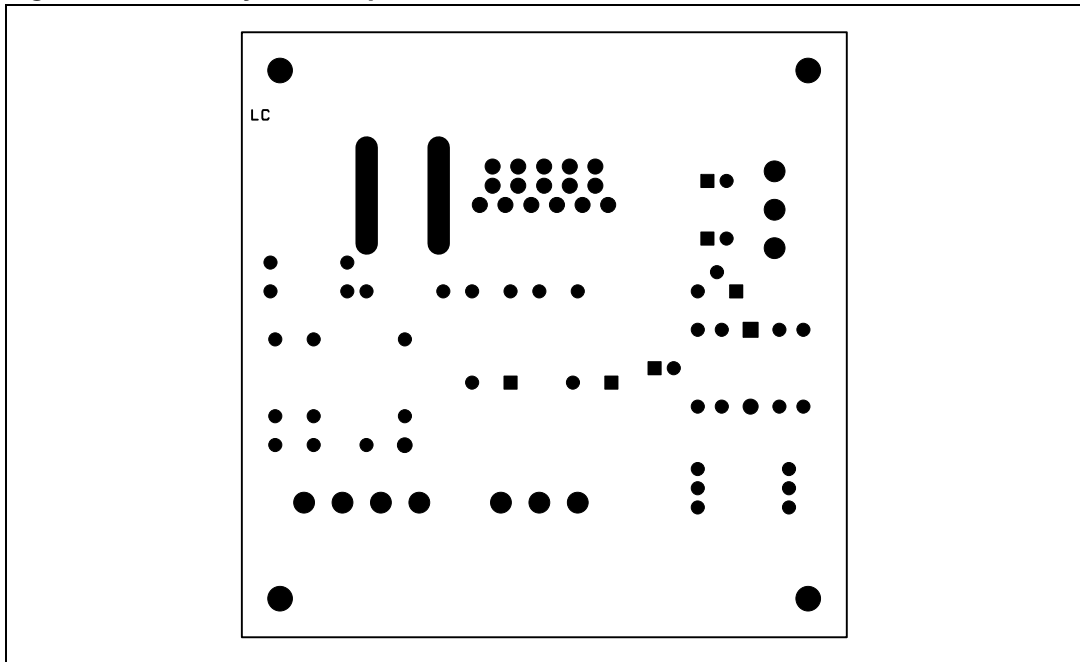
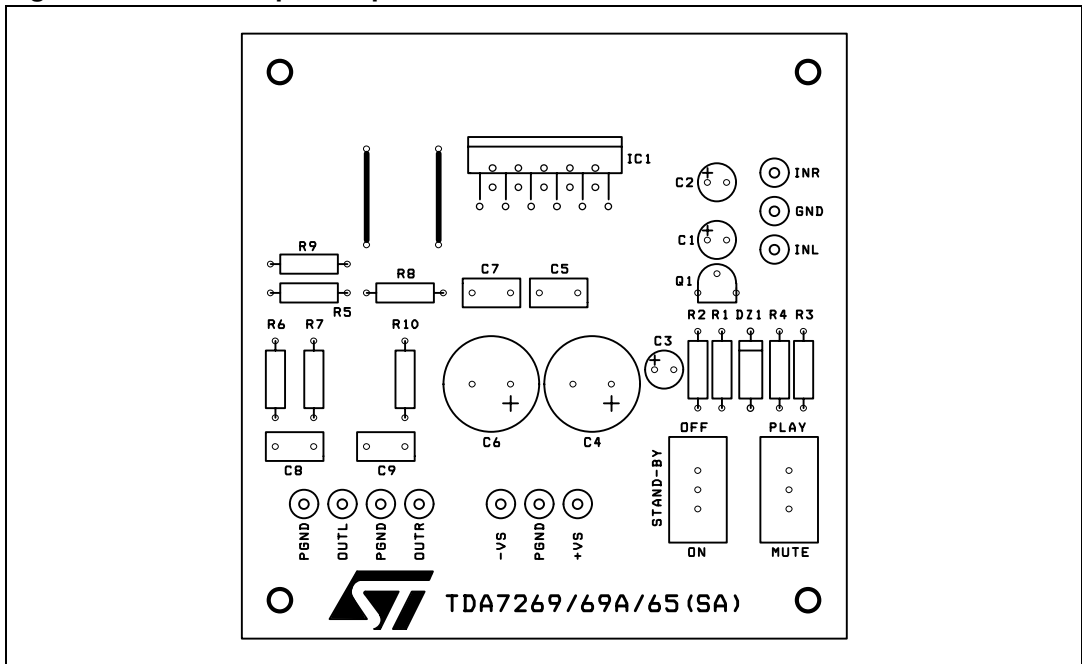
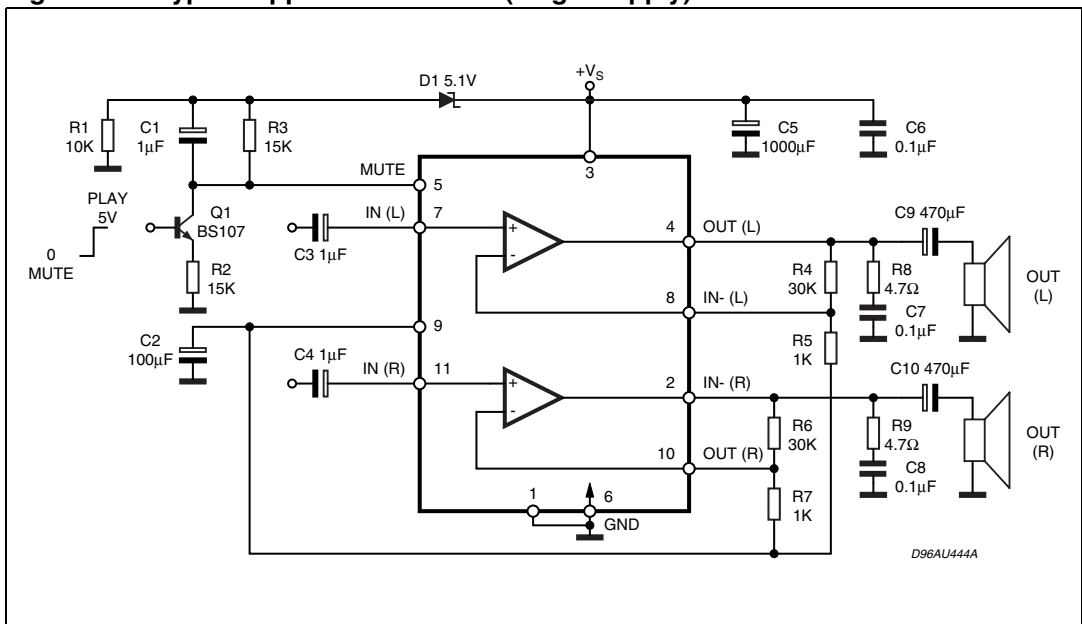

Figure 21. PCB component placement



5.2 Applications with single supply

Figure 22. Typical applications circuit (single supply)



Note: The PCB layout shown in [Figure 23](#), [Figure 24](#), and [Figure 25](#) is common to the pin-to-pin compatible devices TDA7269A, TDA7265, and TDA7265B.

Figure 23. PCB layout, solder side

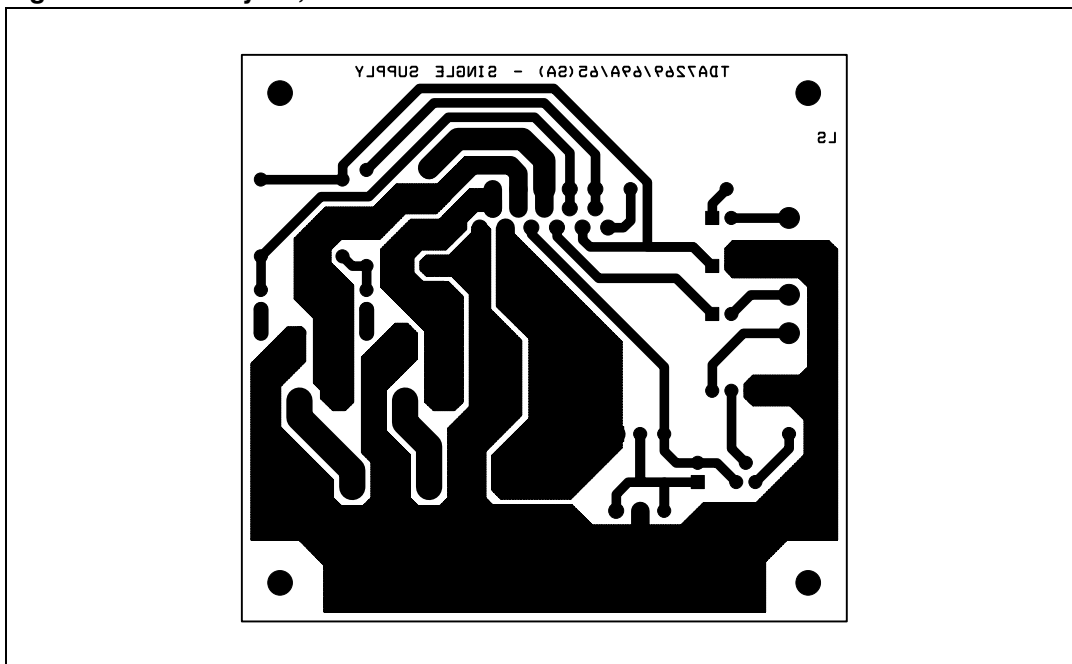

Figure 24. PCB layout, component side

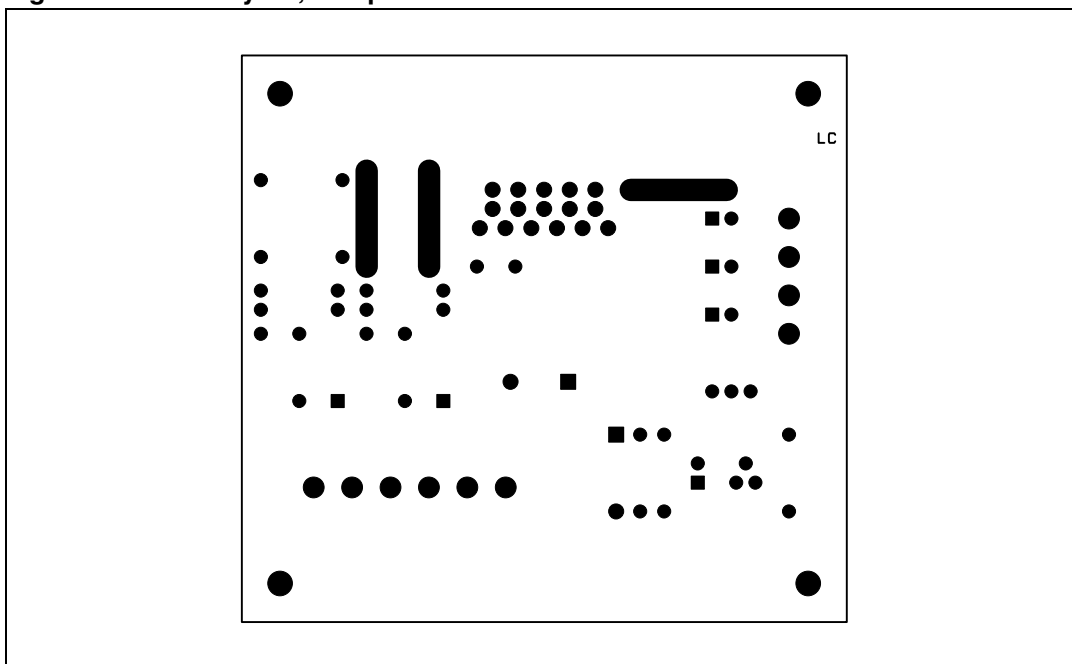
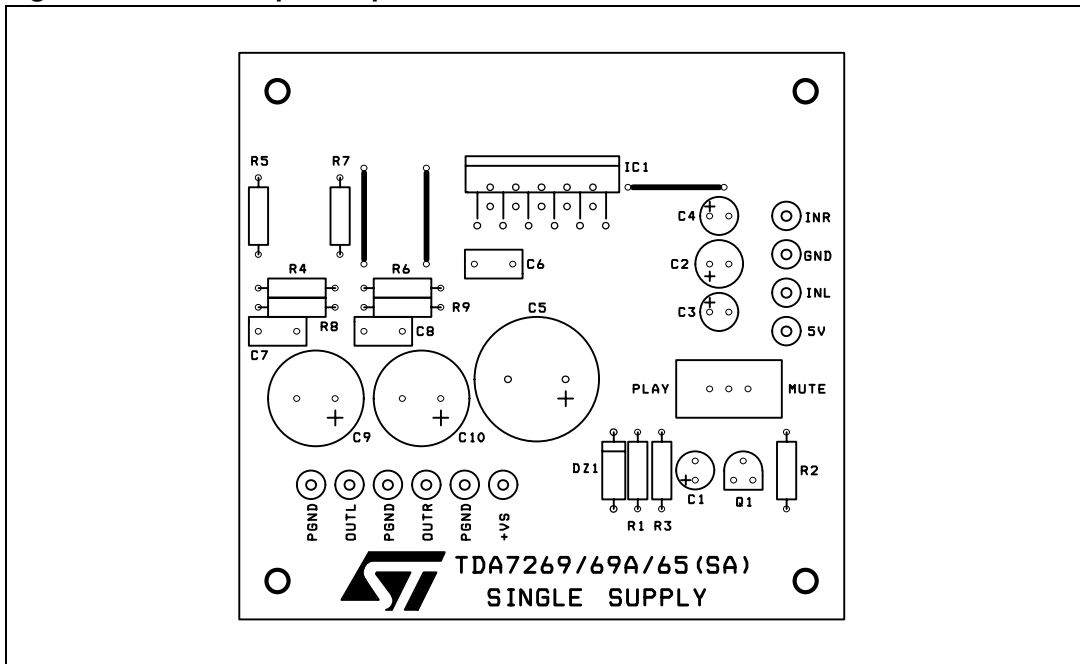

Figure 25. PCB component placement



6 Package mechanical data

The TDA7292 comes in an 11-pin Multiwatt package.

Figure 26. Multiwatt11 outline drawing and dimensions

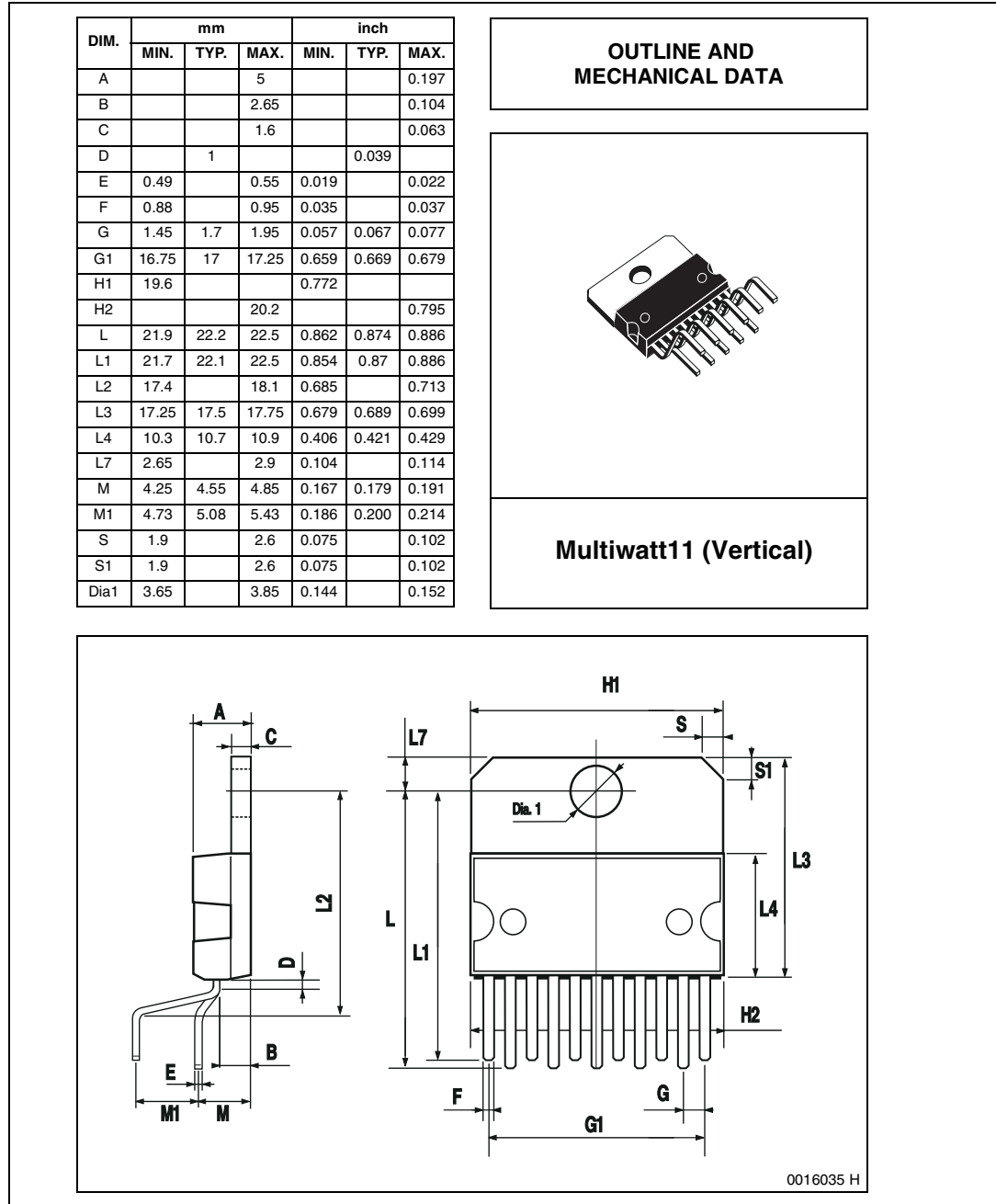

In order to meet environmental requirements, ST offers these devices in different grades of ECOPACK[®] packages, depending on their level of environmental compliance. ECOPACK[®] specifications, grade definitions and product status are available at: www.st.com. ECOPACK[®] is an ST trademark.

7 Revision history

Table 7. Document revision history

Date	Revision	Changes
Nov-2004	1	Initial release.
Oct-2005	2	Inserted PC board and graphics.
Mar-2006	3	Ouput peak current changed.
29-May-2009	4	Updated resistor value setting mute voltage in Figure 1 on page 1 and Table 5 on page 13 .
29-Feb-2012	5	Added Note: on page 16 and Note: on page 18 concerning PCB layout for pin-to-pin compatible devices.

Please Read Carefully:

Information in this document is provided solely in connection with ST products. STMicroelectronics NV and its subsidiaries ("ST") reserve the right to make changes, corrections, modifications or improvements, to this document, and the products and services described herein at any time, without notice.

All ST products are sold pursuant to ST's terms and conditions of sale.

Purchasers are solely responsible for the choice, selection and use of the ST products and services described herein, and ST assumes no liability whatsoever relating to the choice, selection or use of the ST products and services described herein.

No license, express or implied, by estoppel or otherwise, to any intellectual property rights is granted under this document. If any part of this document refers to any third party products or services it shall not be deemed a license grant by ST for the use of such third party products or services, or any intellectual property contained therein or considered as a warranty covering the use in any manner whatsoever of such third party products or services or any intellectual property contained therein.

UNLESS OTHERWISE SET FORTH IN ST'S TERMS AND CONDITIONS OF SALE ST DISCLAIMS ANY EXPRESS OR IMPLIED WARRANTY WITH RESPECT TO THE USE AND/OR SALE OF ST PRODUCTS INCLUDING WITHOUT LIMITATION IMPLIED WARRANTIES OF MERCHANTABILITY, FITNESS FOR A PARTICULAR PURPOSE (AND THEIR EQUIVALENTS UNDER THE LAWS OF ANY JURISDICTION), OR INFRINGEMENT OF ANY PATENT, COPYRIGHT OR OTHER INTELLECTUAL PROPERTY RIGHT.

UNLESS EXPRESSLY APPROVED IN WRITING BY TWO AUTHORIZED ST REPRESENTATIVES, ST PRODUCTS ARE NOT RECOMMENDED, AUTHORIZED OR WARRANTED FOR USE IN MILITARY, AIR CRAFT, SPACE, LIFE SAVING, OR LIFE SUSTAINING APPLICATIONS, NOR IN PRODUCTS OR SYSTEMS WHERE FAILURE OR MALFUNCTION MAY RESULT IN PERSONAL INJURY, DEATH, OR SEVERE PROPERTY OR ENVIRONMENTAL DAMAGE. ST PRODUCTS WHICH ARE NOT SPECIFIED AS "AUTOMOTIVE GRADE" MAY ONLY BE USED IN AUTOMOTIVE APPLICATIONS AT USER'S OWN RISK.

Resale of ST products with provisions different from the statements and/or technical features set forth in this document shall immediately void any warranty granted by ST for the ST product or service described herein and shall not create or extend in any manner whatsoever, any liability of ST.

ST and the ST logo are trademarks or registered trademarks of ST in various countries.

Information in this document supersedes and replaces all information previously supplied.

The ST logo is a registered trademark of STMicroelectronics. All other names are the property of their respective owners.

© 2012 STMicroelectronics - All rights reserved

STMicroelectronics group of companies

Australia - Belgium - Brazil - Canada - China - Czech Republic - Finland - France - Germany - Hong Kong - India - Israel - Italy - Japan - Malaysia - Malta - Morocco - Philippines - Singapore - Spain - Sweden - Switzerland - United Kingdom - United States of America

www.st.com