



Chipsmall Limited consists of a professional team with an average of over 10 year of expertise in the distribution of electronic components. Based in Hongkong, we have already established firm and mutual-benefit business relationships with customers from,Europe,America and south Asia,supplying obsolete and hard-to-find components to meet their specific needs.

With the principle of “Quality Parts,Customers Priority,Honest Operation,and Considerate Service”,our business mainly focus on the distribution of electronic components. Line cards we deal with include Microchip,ALPS,ROHM,Xilinx,Pulse,ON,Everlight and Freescale. Main products comprise IC,Modules,Potentiometer,IC Socket,Relay,Connector.Our parts cover such applications as commercial,industrial, and automotives areas.

We are looking forward to setting up business relationship with you and hope to provide you with the best service and solution. Let us make a better world for our industry!



Contact us

Tel: +86-755-8981 8866 Fax: +86-755-8427 6832

Email & Skype: info@chipsmall.com Web: www.chipsmall.com

Address: A1208, Overseas Decoration Building, #122 Zhenhua RD., Futian, Shenzhen, China



20 W + 20 W dual BTL class-D audio amplifier

Datasheet - production data

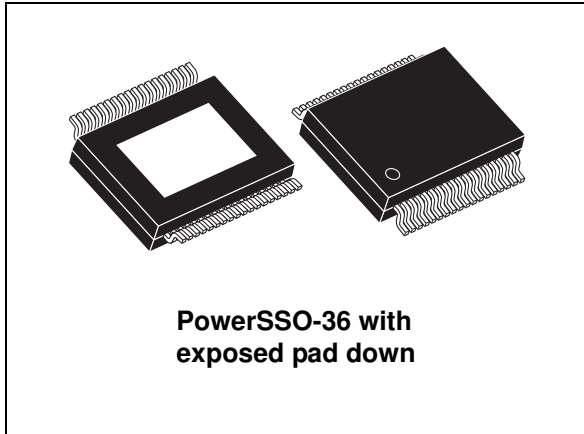

Description

The TDA7491HV is a dual BTL class-D audio amplifier with single power supply designed for LCD TVs and monitors.

Thanks to the high efficiency and exposed-pad-down (EPD) package no separate heatsink is required.

The TDA7491HV is pin-to-pin compatible with the TDA7491P and TDA7491LP.

Features

- 20 W + 20 W continuous output power:
 $R_L = 8 \Omega$, THD = 10% at $V_{CC} = 18 \text{ V}$
- Wide-range single-supply operation (5 V - 18 V)
- High efficiency ($\eta = 90\%$)
- Four selectable, fixed gain settings of nominally 20 dB, 26 dB, 30 dB and 32 dB
- Differential inputs minimize common mode noise
- No 'pop' at turn-on/off
- Standby and mute features
- Short-circuit protection
- Thermal overload protection
- Externally synchronizable

Table 1. Device summary

Order code	Operating temperature	Package	Packaging
TDA7491HV13TR	-40 to 85°C	PowerSSO-36 EPD	Tape and reel

Contents

- 1 Device block diagram 7**
- 2 Pin description 8**
 - 2.1 Pinout 8
 - 2.2 Pin list 9
- 3 Electrical specifications 10**
 - 3.1 Absolute maximum ratings 10
 - 3.2 Thermal data 10
 - 3.3 Electrical specifications 10
- 4 Characterization curves 12**
 - 4.1 With 4 Ω load at V_{CC} = 14 V 12
 - 4.2 With 6 Ω load at V_{CC} = 16 V 17
 - 4.3 With 8 Ω load at V_{CC} = 18 V 23
 - 4.4 Test board 29
- 5 Package mechanical data 30**
- 6 Applications circuit 32**
- 7 Application information 33**
 - 7.1 Mode selection 33
 - 7.2 Gain setting 34
 - 7.3 Input resistance and capacitance 34
 - 7.4 Internal and external clocks 36
 - 7.4.1 Master mode (internal clock) 36
 - 7.4.2 Slave mode (external clock) 36
 - 7.5 Modulation 37
 - 7.6 Reconstruction low-pass filter 39
 - 7.7 Protection functions 40
 - 7.8 Diagnostic output 40
 - 7.9 Heatsink requirements 40

8 **Revision history** **42**

List of tables

Table 1.	Device summary	1
Table 2.	Pin description list	9
Table 3.	Absolute maximum ratings	10
Table 4.	Thermal data	10
Table 5.	Electrical specifications	10
Table 6.	PowerSSO-36 EPD dimensions	31
Table 7.	Mode settings	33
Table 8.	Gain settings	34
Table 9.	How to set up SYNCLK	36
Table 10.	Document revision history	42

List of figures

Figure 1.	Internal block diagram (one channel only)	7
Figure 2.	Pin connections (top view, PCB view)	8
Figure 3.	Output power vs. supply voltage	12
Figure 4.	THD vs. output power (1 kHz)	12
Figure 5.	THD vs. output power (100 Hz)	13
Figure 6.	THD vs. frequency	13
Figure 7.	Frequency response	13
Figure 8.	Crosstalk vs. frequency	14
Figure 9.	FFT (0 dB)	14
Figure 10.	FFT (-60 dB)	14
Figure 11.	Power supply rejection ratio vs. frequency	15
Figure 12.	Power dissipation and efficiency vs. output power	15
Figure 13.	Closed-loop gain vs. frequency	15
Figure 14.	Current consumption vs. voltage on pin MUTE	16
Figure 15.	Attenuation vs. voltage on pin MUTE	16
Figure 16.	Current consumption vs. voltage on pin STBY	16
Figure 17.	Attenuation vs. voltage on pin STBY	17
Figure 18.	Output power vs. supply voltage	17
Figure 19.	THD vs. output power (1 kHz)	18
Figure 20.	THD vs. output power (100 Hz)	18
Figure 21.	THD vs. frequency	18
Figure 22.	Frequency response	19
Figure 23.	Crosstalk vs. frequency	19
Figure 24.	FFT (0 dB)	19
Figure 25.	FFT (-60 dB)	20
Figure 26.	Power supply rejection ratio vs. frequency	20
Figure 27.	Power dissipation and efficiency vs. output power	20
Figure 28.	Closed-loop gain vs. frequency	21
Figure 29.	Current consumption vs. voltage on pin MUTE	21
Figure 30.	Attenuation vs. voltage on pin MUTE	21
Figure 31.	Current consumption vs. voltage on pin STBY	22
Figure 32.	Attenuation vs. voltage on pin STBY	22
Figure 33.	Output power vs. supply voltage	23
Figure 34.	THD vs. output power (1 kHz)	23
Figure 35.	THD vs. output power (100 Hz)	24
Figure 36.	THD vs. frequency	24
Figure 37.	Frequency response	24
Figure 38.	Crosstalk vs. frequency	25
Figure 39.	FFT (0 dB)	25
Figure 40.	FFT (-60 dB)	25
Figure 41.	Power supply rejection ratio vs. frequency	26
Figure 42.	Power dissipation and efficiency vs. output power	26
Figure 43.	Closed-loop gain vs. frequency	26
Figure 44.	Current consumption vs. voltage on pin MUTE	27
Figure 45.	Attenuation vs. voltage on pin MUTE	27
Figure 46.	Current consumption vs. voltage on pin STBY	27
Figure 47.	Attenuation vs. voltage on pin STBY	28
Figure 48.	Test board (TDA7491HV) layout	29

Figure 49.	PowerSSO-36 EPD outline drawing	30
Figure 50.	Applications circuit for class-D amplifier	32
Figure 51.	Standby and mute circuits	33
Figure 52.	Turn-on/off sequence for minimizing speaker “pop”	34
Figure 53.	Device input circuit and frequency response	35
Figure 54.	Master and slave connection	37
Figure 55.	Unipolar PWM output	38
Figure 56.	Typical LC filter for an 8 Ω speaker	39
Figure 57.	Typical LC filter for a 4 Ω speaker	39
Figure 58.	Behavior of pin DIAG for various protection conditions	40
Figure 59.	Power derating curves for PCB used as heatsink	41

1 Device block diagram

Figure 1 shows the block diagram of one of the two identical channels of the TDA7491HV.

Figure 1. Internal block diagram (one channel only)

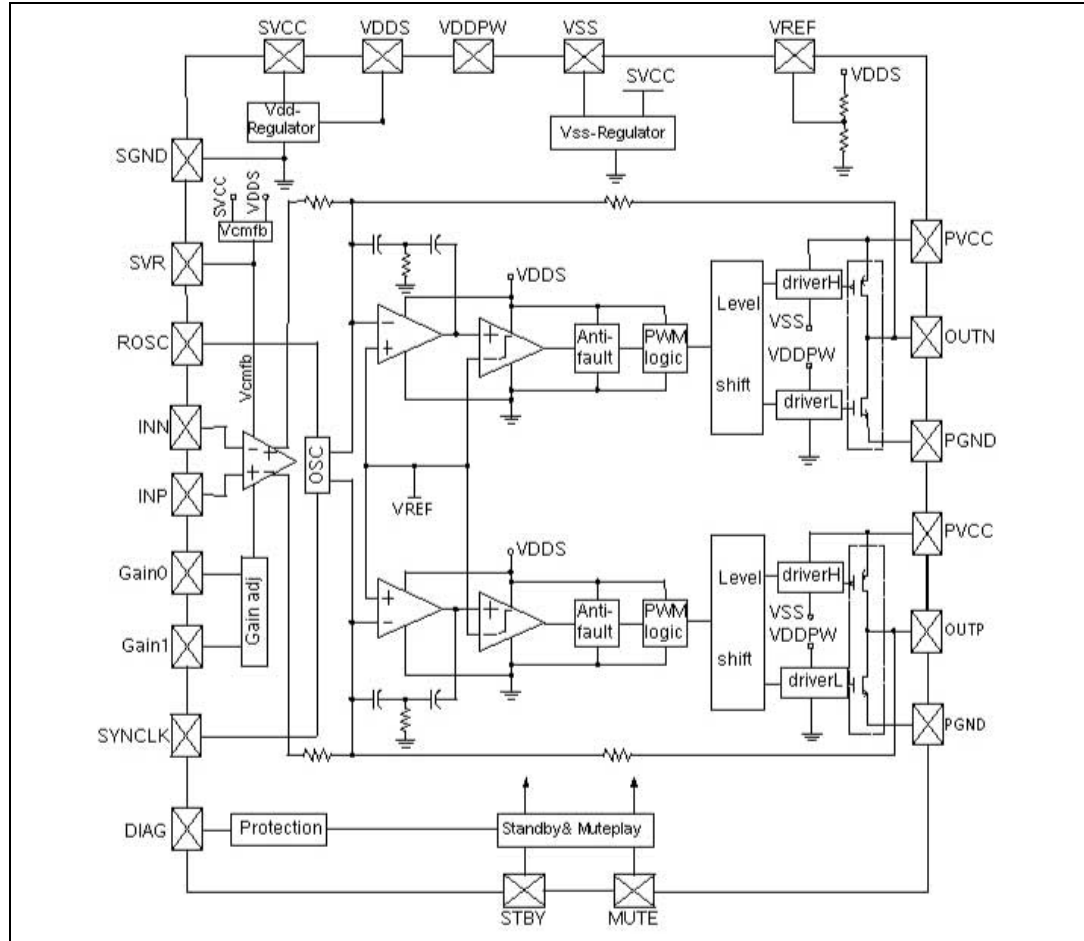

2 Pin description

2.1 Pinout

Figure 2. Pin connections (top view, PCB view)

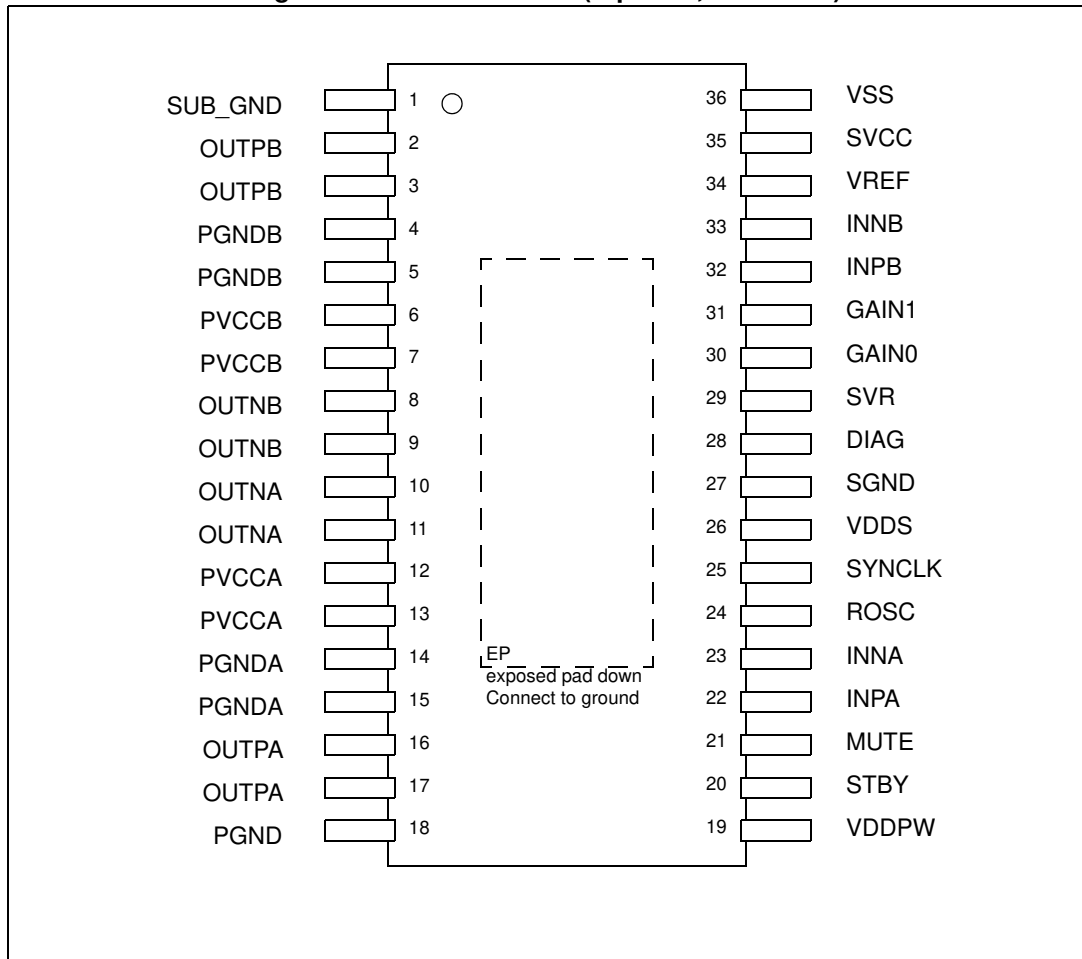

2.2 Pin list

Table 2. Pin description list

Pin n°	Name	Type	Description
1	SUB_GND	POWER	Connect to the frame
2,3	OUTPB	OUT	Positive PWM for right channel
4,5	PGNDB	POWER	Power stage ground for right channel
6,7	PVCCB	POWER	Power supply for right channel
8,9	OUTNB	OUT	Negative PWM output for right channel
10,11	OUTNA	OUT	Negative PWM output for left channel
12,13	PVCCA	POWER	Power supply for left channel
14,15	PGNDA	POWER	Power stage ground for left channel
16,17	OUTPA	OUT	Positive PWM output for left channel
18	PGND	POWER	Power stage ground
19	VDDPW	OUT	3.3-V (nominal) regulator output referred to ground for power stage
20	STBY	INPUT	Standby mode control
21	MUTE	INPUT	Mute mode control
22	INPA	INPUT	Positive differential input of left channel
23	INNA	INPUT	Negative differential input of left channel
24	ROSC	OUT	Master oscillator frequency-setting pin
25	SYNCLCK	IN/OUT	Clock in/out for external oscillator
26	VDDS	OUT	3.3-V (nominal) regulator output referred to ground for signal blocks
27	SGND	POWER	Signal ground
28	DIAG	OUT	Open-drain diagnostic output
29	SVR	OUT	Supply voltage rejection
30	GAIN0	INPUT	Gain setting input 1
31	GAIN1	INPUT	Gain setting input 2
32	INPB	INPUT	Positive differential input of right channel
33	INNB	INPUT	Negative differential input of right channel
34	VREF	OUT	Half VDDS (nominal) referred to ground
35	SVCC	POWER	Signal power supply
36	VSS	OUT	3.3-V (nominal) regulator output referred to power supply
-	EP	-	Exposed pad for ground-plane heatsink, to be connected to GND

3 Electrical specifications

3.1 Absolute maximum ratings

Table 3. Absolute maximum ratings

Symbol	Parameter	Value	Unit
V_{CC}	DC supply voltage for pins PVCCA, PVCCB	23	V
V_i	Voltage limits for input pins STBY,MUTE,INNA,INPA,INNB INPB,GAIN0,GAIN1	-0.3 TO 3.6	V
T_{op}	Operating temperature	-40 to 85	°C
T_j	Junction temperature	-40 to 150	°C
T_{stg}	Storage temperature	-40 to 150	°C

3.2 Thermal data

Refer also to [Section 7.9: Heatsink requirements on page 40](#).

Table 4. Thermal data

Symbol	Parameter	Min	Typ	Max	Unit
$R_{th\ j-case}$	Thermal resistance, junction to case	-	2	3	°C/W
$R_{th\ j-amb}$	Thermal resistance, junction to ambient (mounted on recommended PCB) ⁽¹⁾	-	24	-	

1. FR4 with vias to copper area of 9 cm².

3.3 Electrical specifications

Unless otherwise stated, the results in [Table 5](#) below are given for the conditions:

$V_{CC} = 18\text{ V}$, R_L (load) = 8 Ω , $R_{OSC} = R3 = 39\text{ k}\Omega$, $C8 = 100\text{ nF}$, $f = 1\text{ kHz}$, $G_V = 20\text{ dB}$, and $T_{amb} = 25\text{ °C}$.

Table 5. Electrical specifications

Symbol	Parameter	Condition	Min	Typ	Max	Unit
V_{CC}	Supply voltage	-	5	-	18	V
I_q	Total quiescent current	-	-	26	35	mA
I_{qSTBY}	Quiescent current in standby	-	-	2.5	5.0	μA
V_{OS}	Output offset voltage	Play mode	-100	-	100	mV
		Mute mode	-60	-	60	mV
I_{OCP}	Overcurrent protection threshold	$R_L = 0\ \Omega$	3	5	-	A
T_j	Junction temperature at thermal shutdown	-	-	150	-	°C
R_i	Input resistance	Differential input	54	60	-	k Ω

Table 5. Electrical specifications (continued)

Symbol	Parameter	Condition	Min	Typ	Max	Unit
V_{UVP}	Undervoltage protection threshold	-	-	-	4.5	V
R_{dsON}	Power transistor on resistance	High side	-	0.2	-	Ω
		Low side	-	0.2	-	
P_o	Output power	THD = 10%	-	20	-	W
		THD = 1%	-	16	-	
P_o	Output power	$R_L = 8 \Omega$, THD = 10% $V_{CC} = 12 V$	-	9.5	-	W
		$R_L = 8 \Omega$, THD = 1% $V_{CC} = 12 V$	-	7.2	-	
P_D	Dissipated power	$P_o = 20 W + 20 W$, THD = 10%	-	4.0	-	W
η	Efficiency	$P_o = 20 W + 20 W$	80	90	-	%
THD	Total harmonic distortion	$P_o = 1 W$	-	0.1	-	%
G_V	Closed loop gain	GAIN0 = L, GAIN1 = L	18	20	22	dB
		GAIN0 = L, GAIN1 = H	24	26	28	
		GAIN0 = H, GAIN1 = L	28	30	32	
		GAIN0 = H, GAIN1 = H	30	32	34	
ΔG_V	Gain matching	-	-1	-	1	dB
CT	Cross talk	$f = 1 kHz$, $P_o = 1 W$	-	70	-	dB
eN	Total input noise	A Curve, $G_V = 20 dB$	-	15	-	μV
		$f = 22 Hz$ to $22 kHz$	-	20	-	
SVRR	Supply voltage rejection ratio	$f_r = 100 Hz$, $V_r = 1 V_{pp}$, $C_{SVR} = 10 \mu F$	-	50	-	dB
T_r, T_f	Rise and fall times	-	-	40	-	ns
f_{SW}	Switching frequency	Internal oscillator, master mode	290	320	350	kHz
f_{SWR}	Switching frequency range	(1)	250	-	400	kHz
V_{inH}	Digital input high (H)	-	2.3	-	-	V
V_{inL}	Digital input low (L)		-	-	0.8	
A_{MUTE}	Mute attenuation	$V_{MUTE} = low$ $V_{STBY} = high$	-	80	-	dB
Function mode	Standby, mute and play modes	$V_{STBY} < 0.5 V$ $V_{MUTE} = X$	Standby			-
		$V_{STBY} > 2.9 V$, $V_{MUTE} < 0.8 V$	Mute			-
		$V_{STBY} > 2.9 V$, $V_{MUTE} > 2.9 V$	Play			-

1. Refer to [Section 7.4: Internal and external clocks on page 36](#).

4 Characterization curves

The following characterization curves were made using the TDA7491HV demo board. The LC filter for the 4-Ω load uses components of 15 μH and 470 nF, whilst that for the 6-Ω load uses 22 μH and 220 nF and that for the 8-Ω load uses 33 μH and 220 nF.

4.1 With 4 Ω load at V_{CC} = 14 V

Figure 3. Output power vs. supply voltage

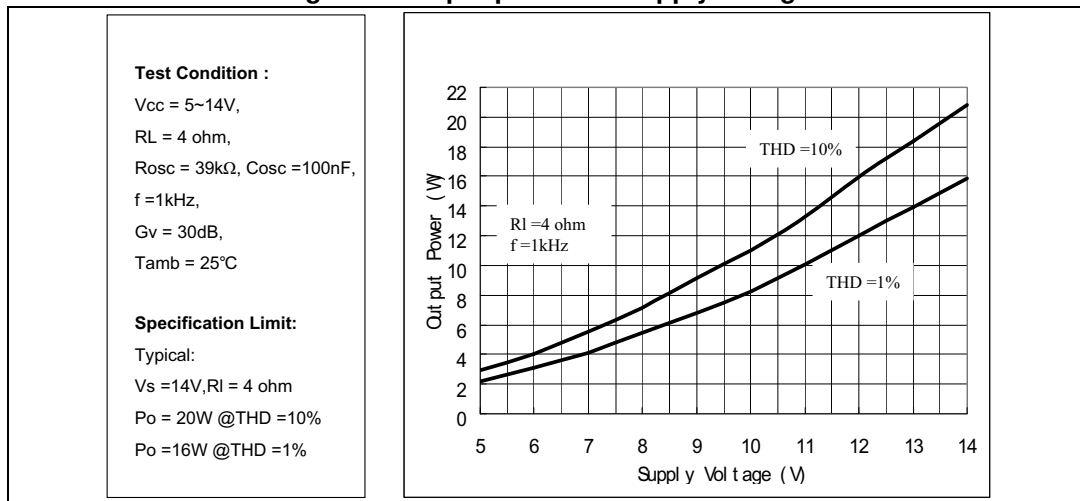

Figure 4. THD vs. output power (1 kHz)

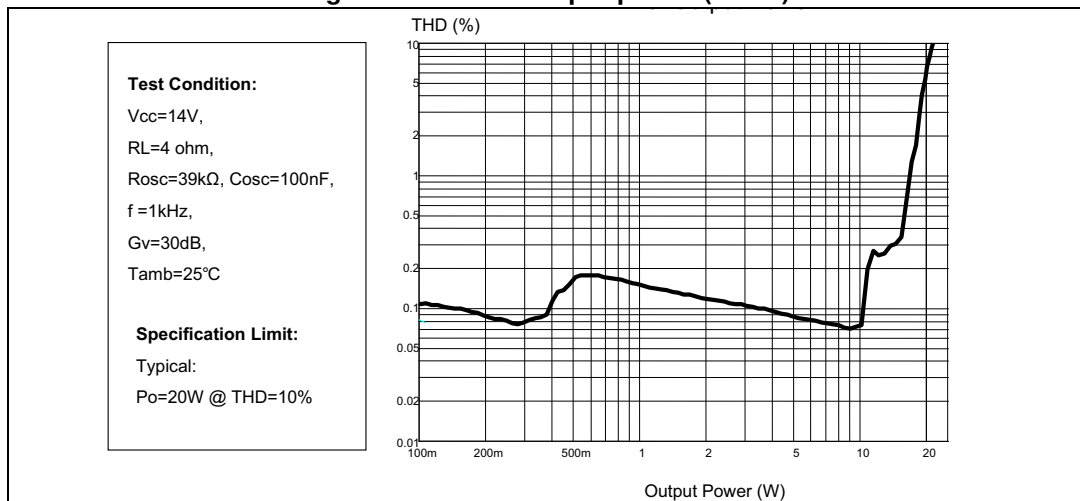

Figure 5. THD vs. output power (100 Hz)

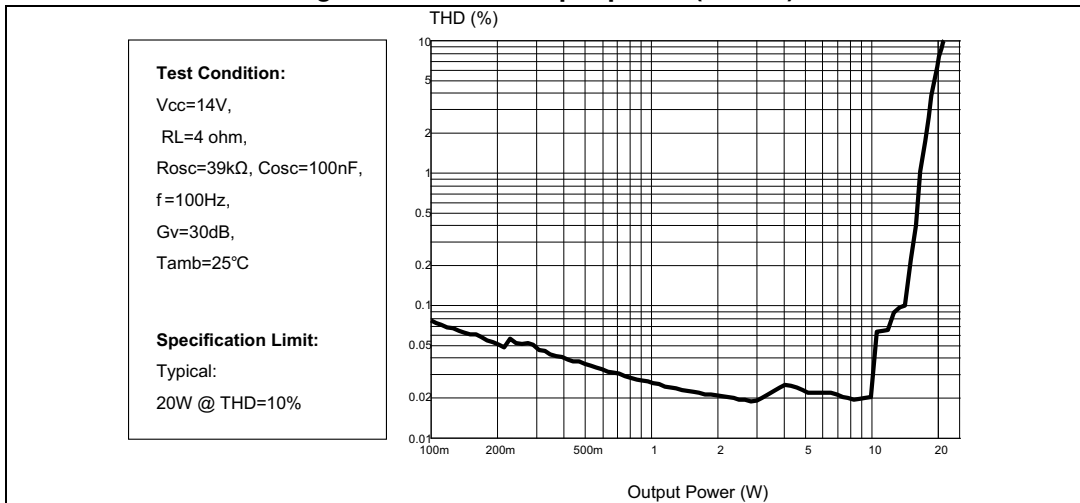

Figure 6. THD vs. frequency

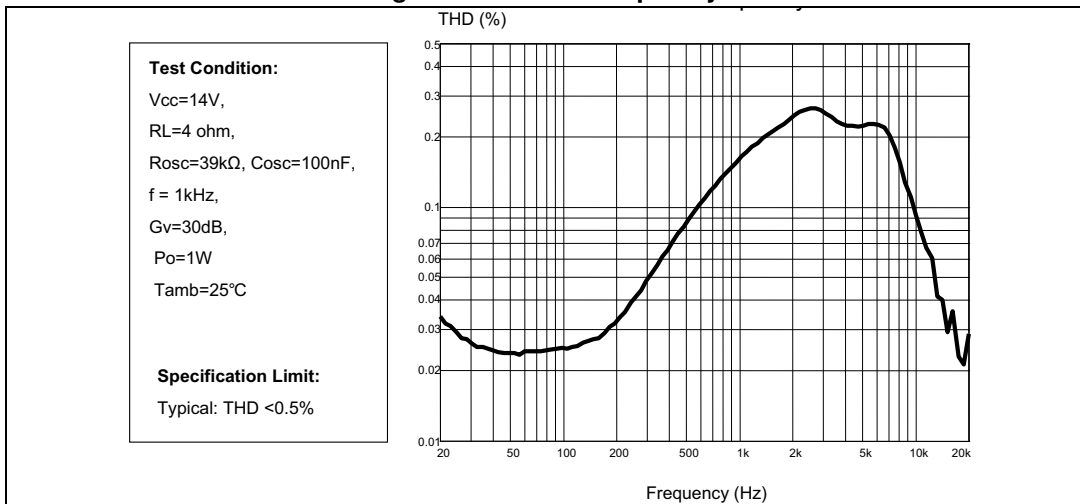

Figure 7. Frequency response

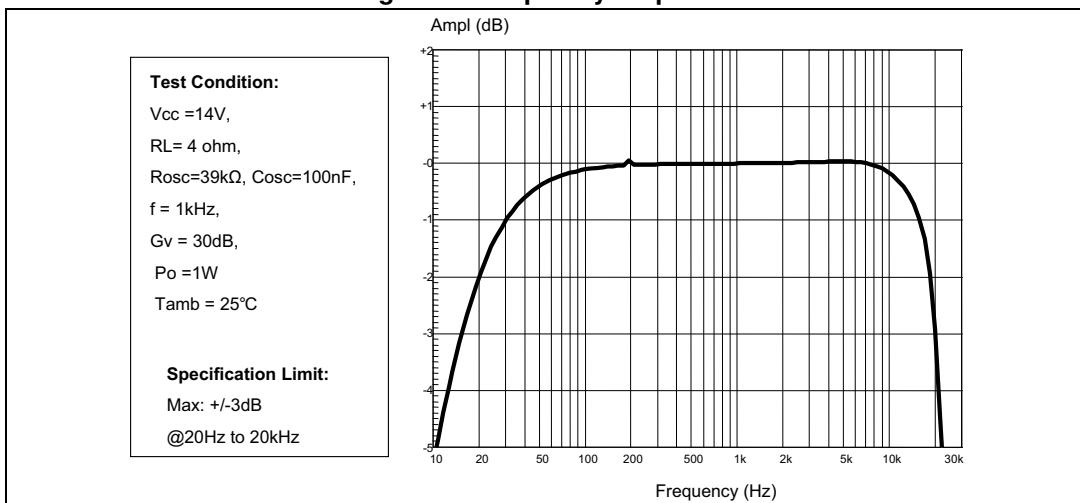

Figure 8. Crosstalk vs. frequency

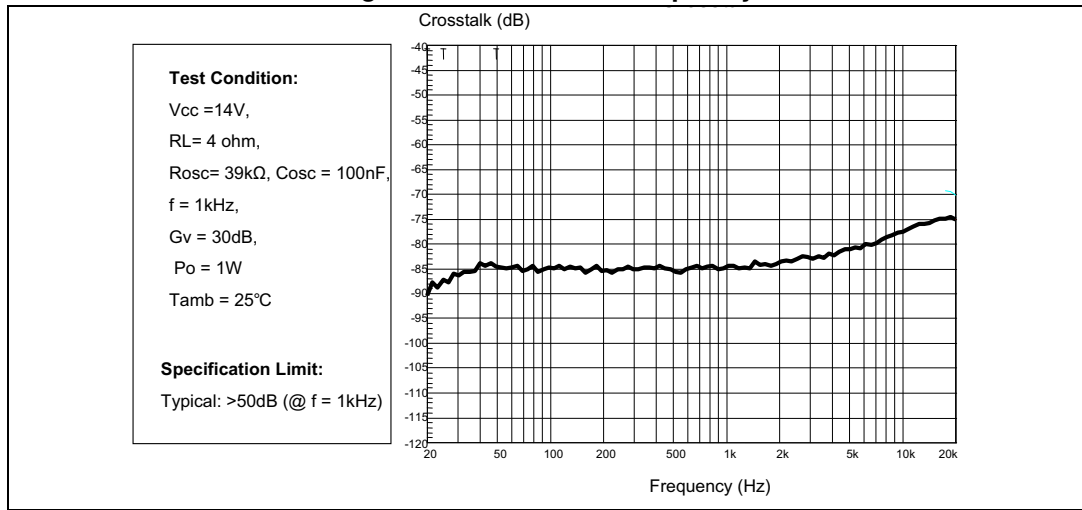

Figure 9. FFT (0 dB)

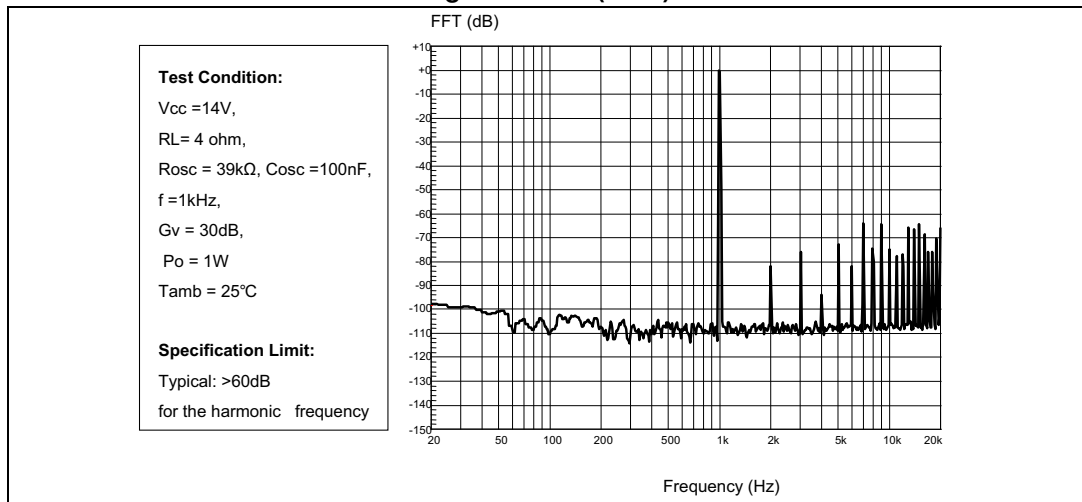

Figure 10. FFT (-60 dB)

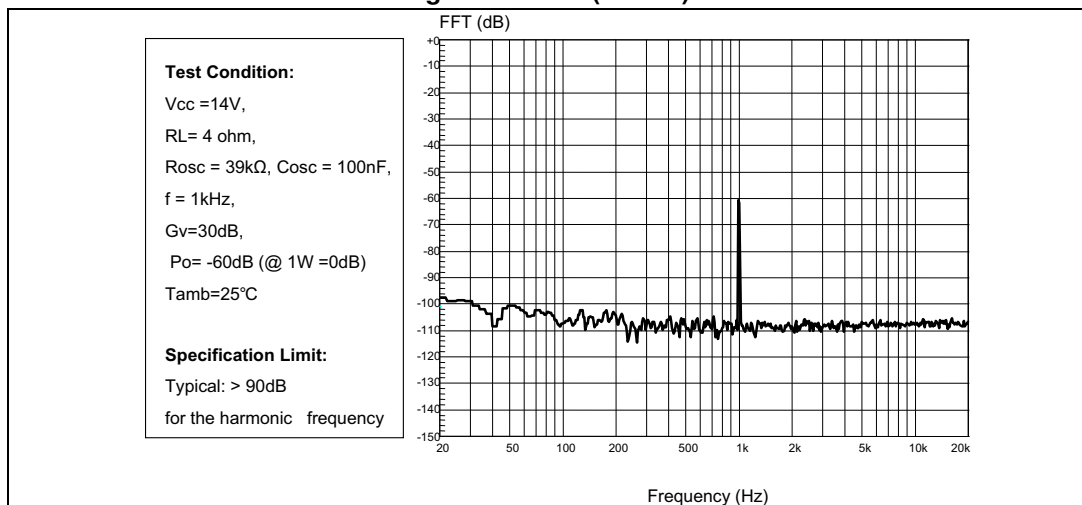

Figure 11. Power supply rejection ratio vs. frequency

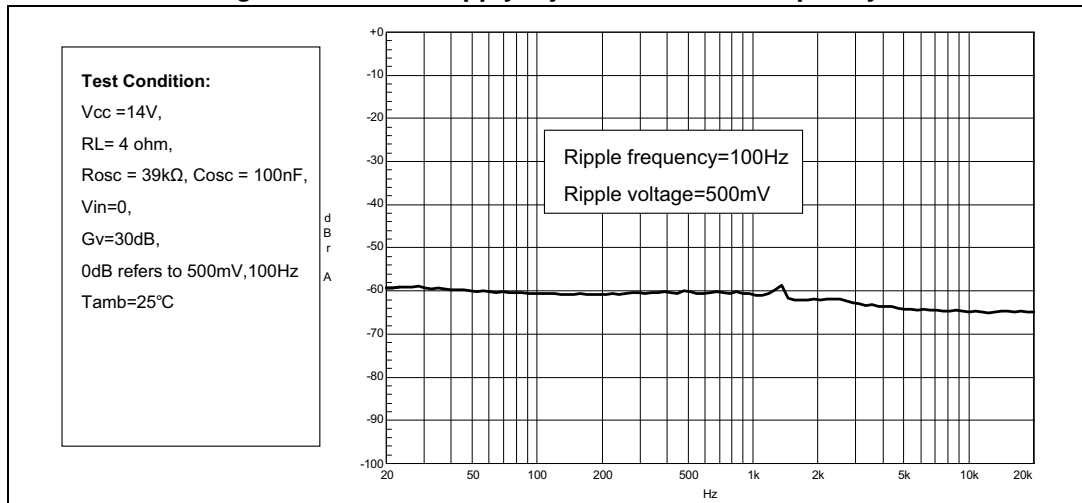

Figure 12. Power dissipation and efficiency vs. output power

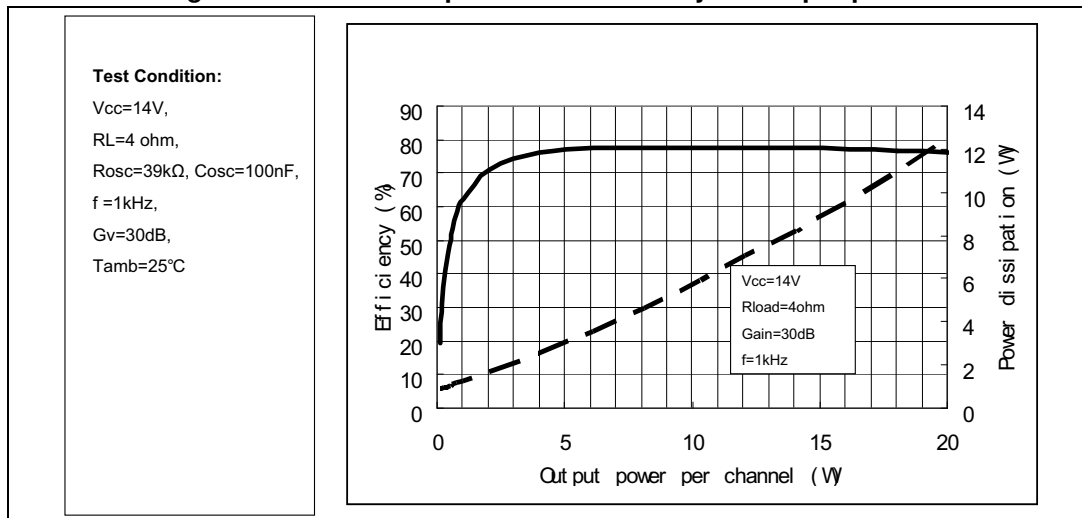

Figure 13. Closed-loop gain vs. frequency

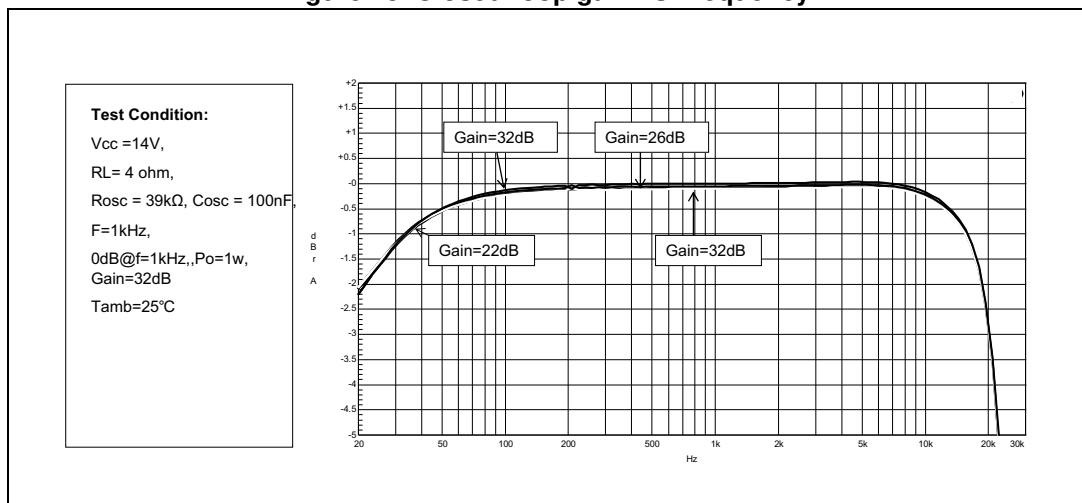

Figure 14. Current consumption vs. voltage on pin MUTE

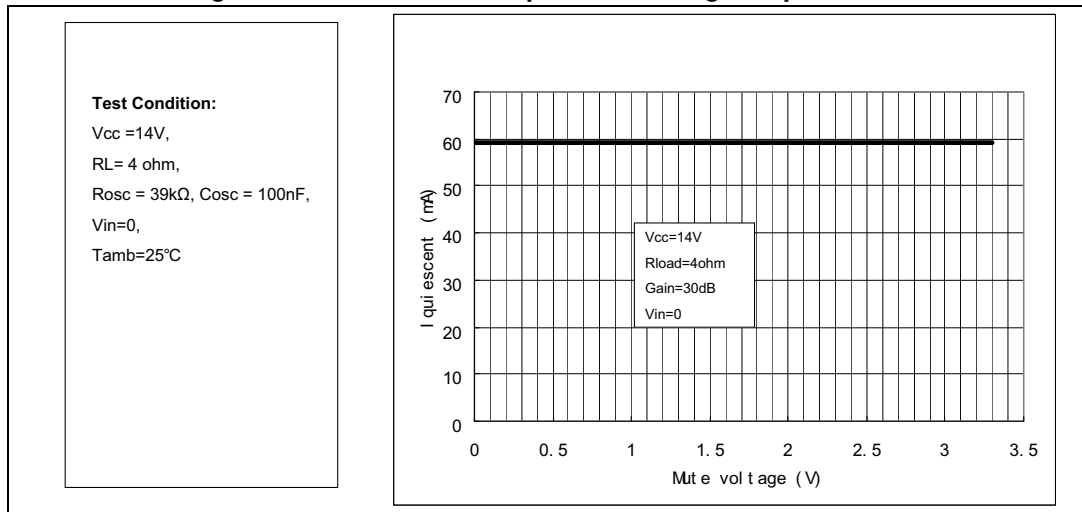

Figure 15. Attenuation vs. voltage on pin MUTE

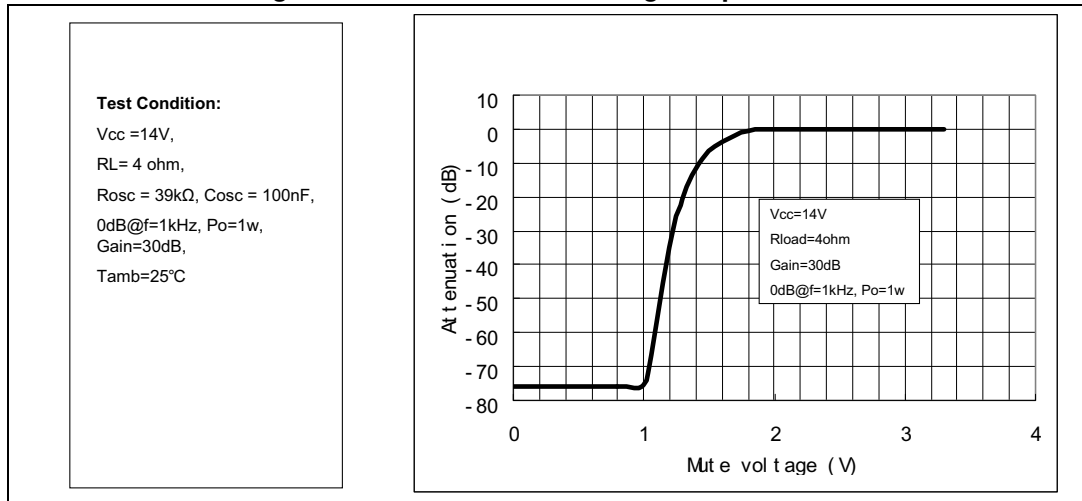

Figure 16. Current consumption vs. voltage on pin STBY

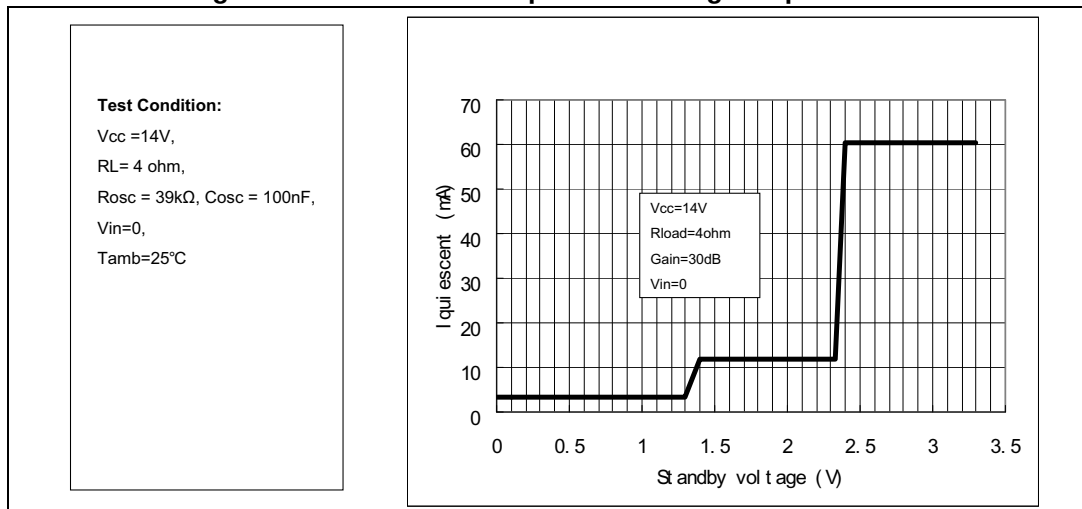
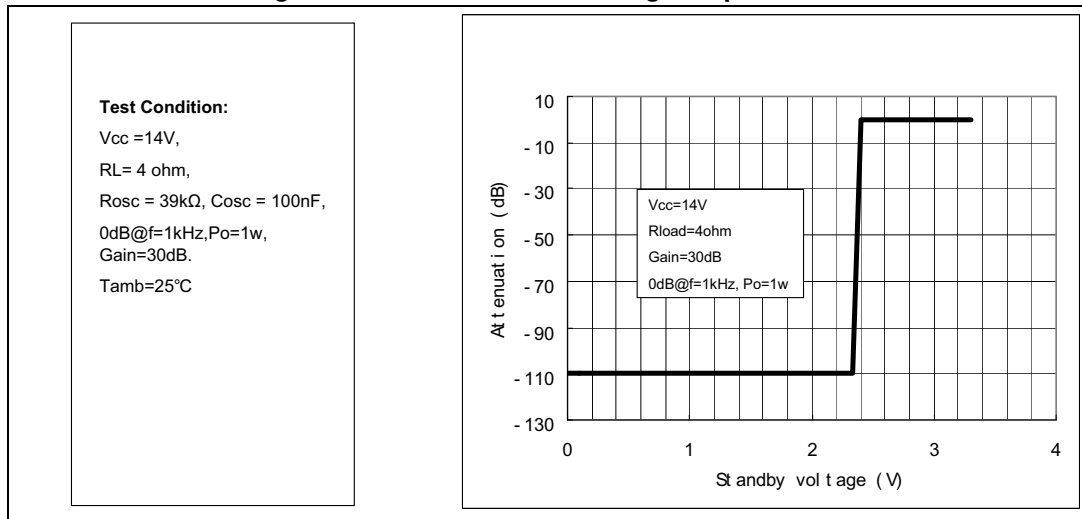

Figure 17. Attenuation vs. voltage on pin STBY



4.2 With 6 Ω load at V_{CC} = 16 V

Figure 18. Output power vs. supply voltage

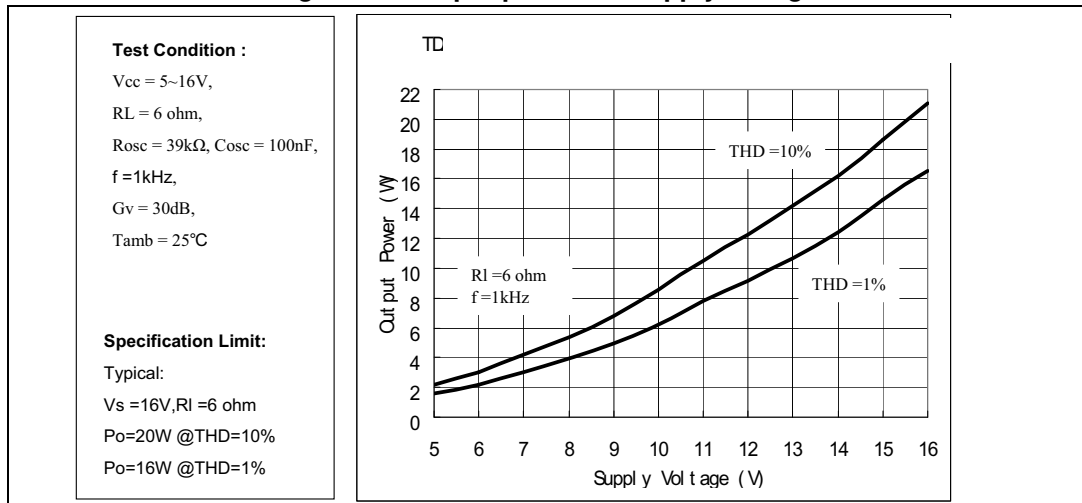

Figure 19. THD vs. output power (1 kHz)

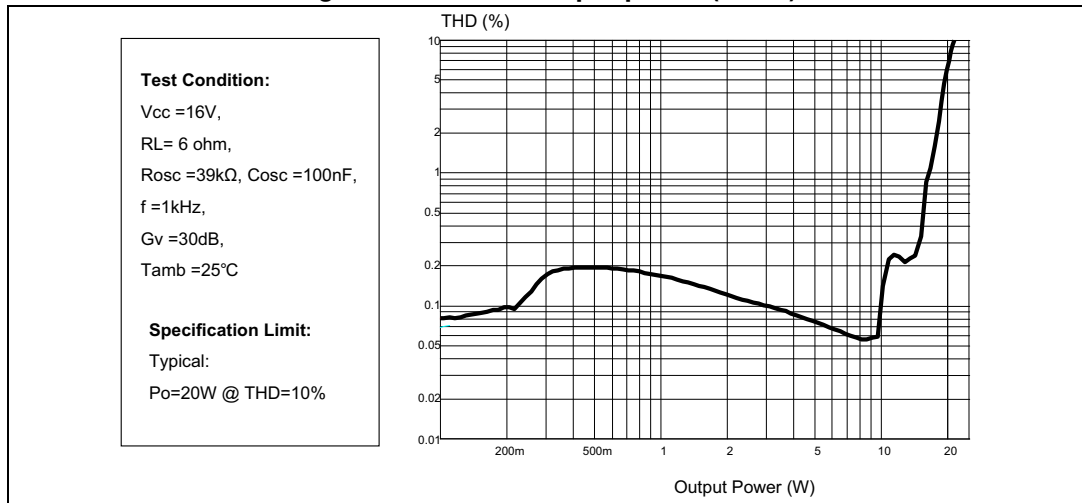

Figure 20. THD vs. output power (100 Hz)

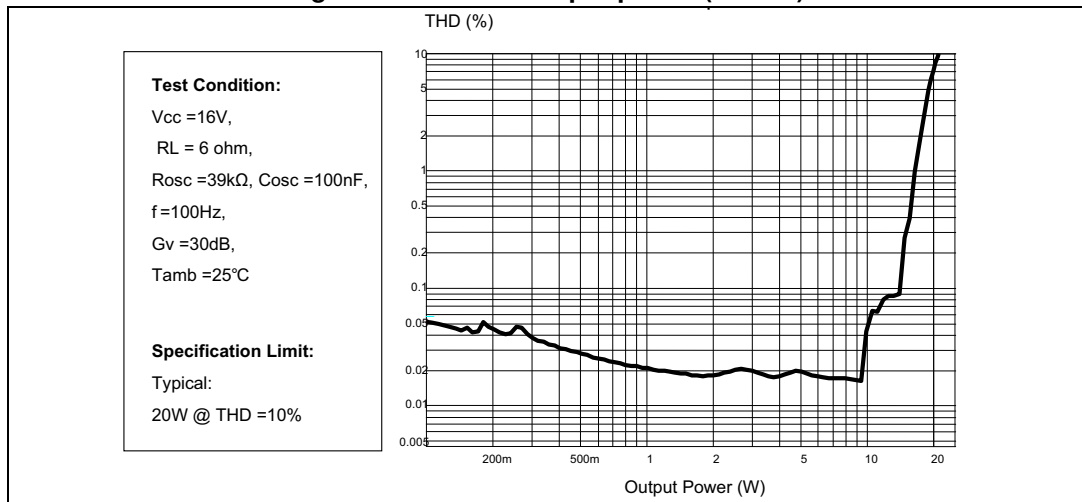

Figure 21. THD vs. frequency

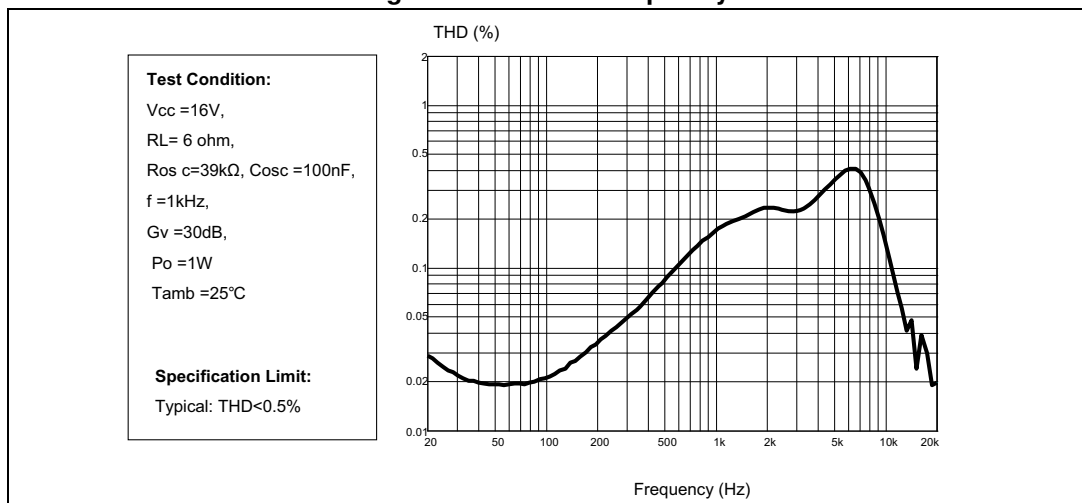

Figure 22. Frequency response

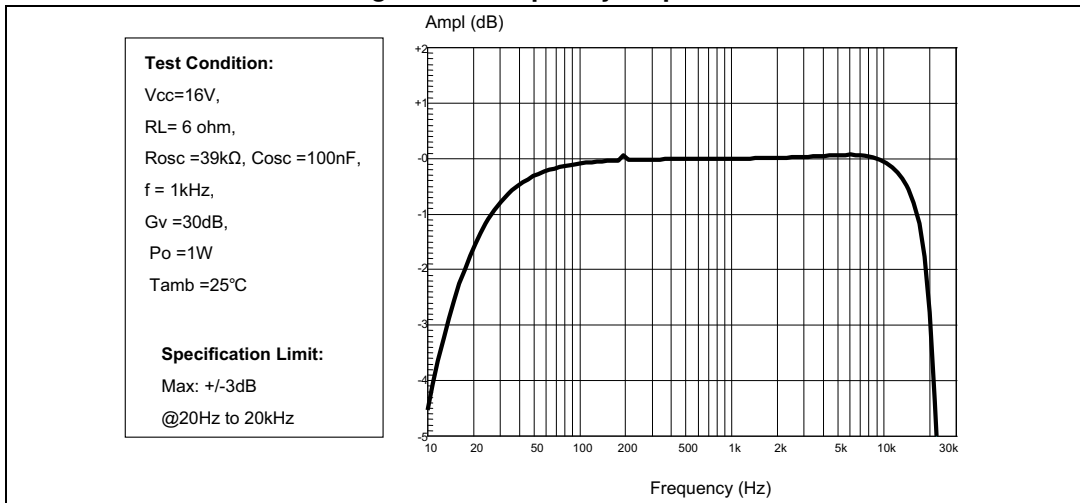

Figure 23. Crosstalk vs. frequency

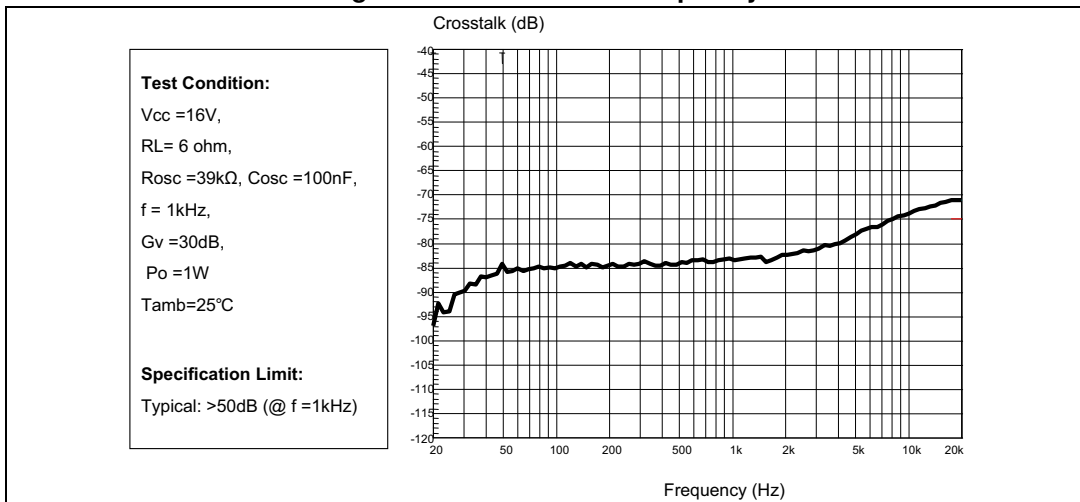

Figure 24. FFT (0 dB)

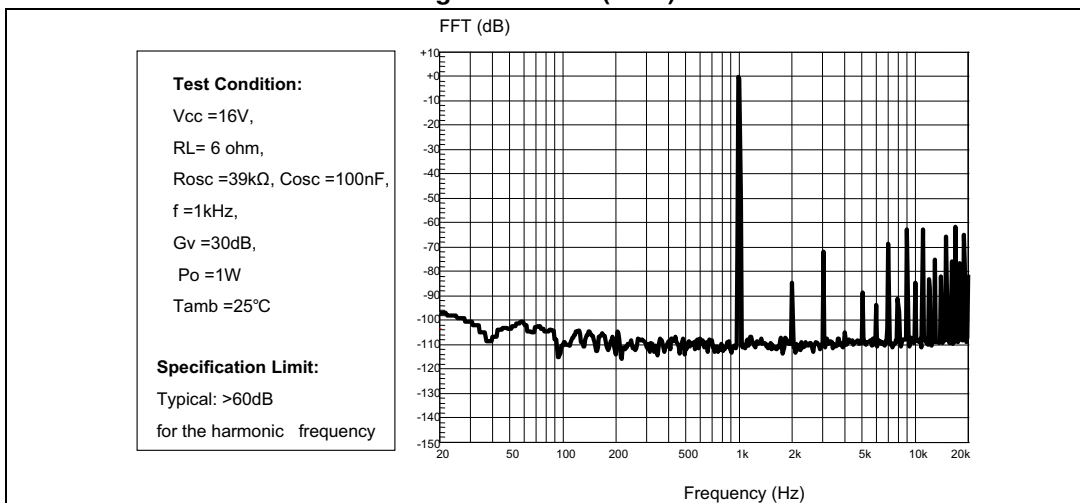

Figure 25. FFT (-60 dB)

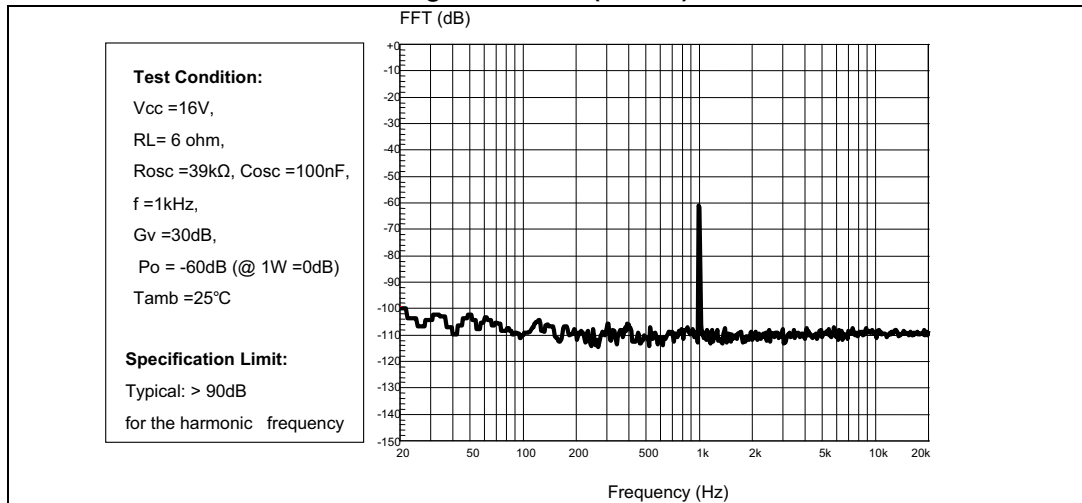

Figure 26. Power supply rejection ratio vs. frequency

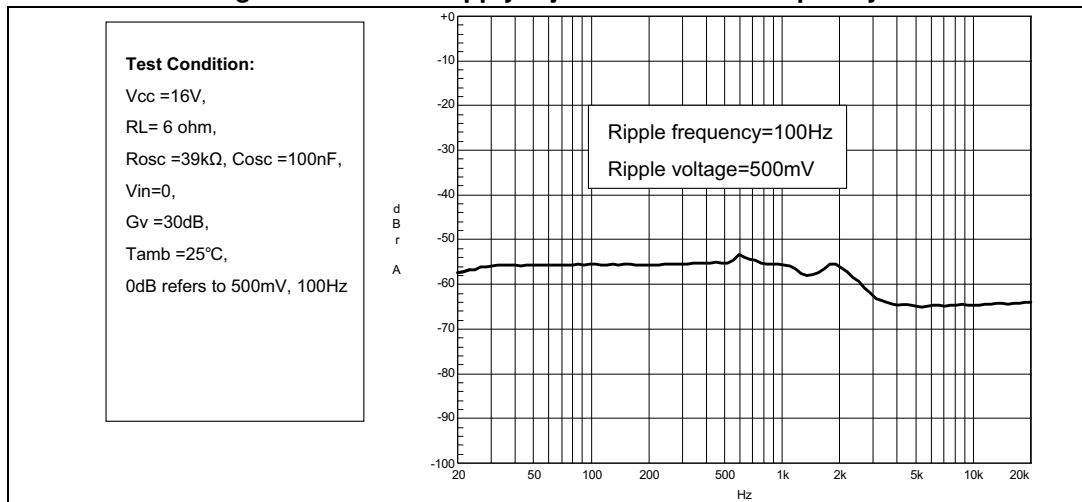

Figure 27. Power dissipation and efficiency vs. output power

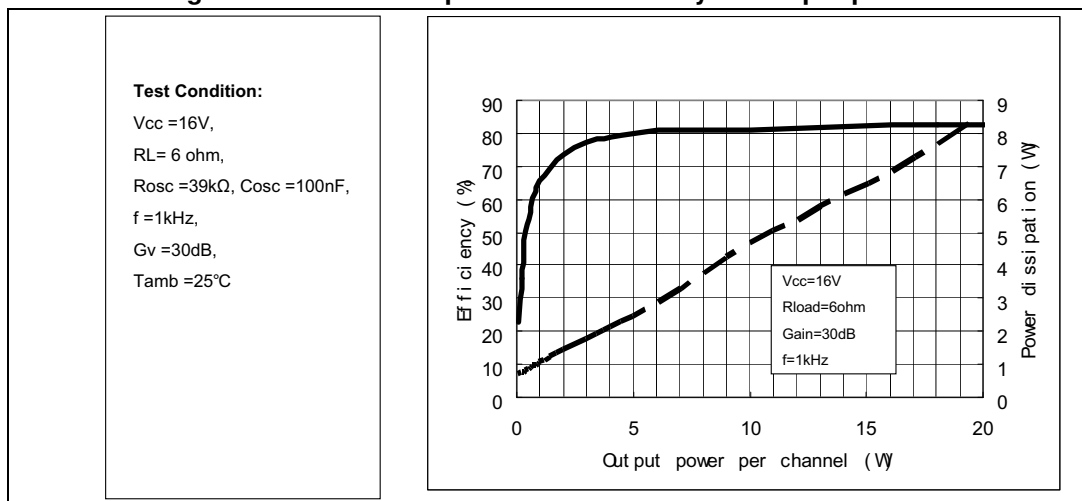

Figure 28. Closed-loop gain vs. frequency

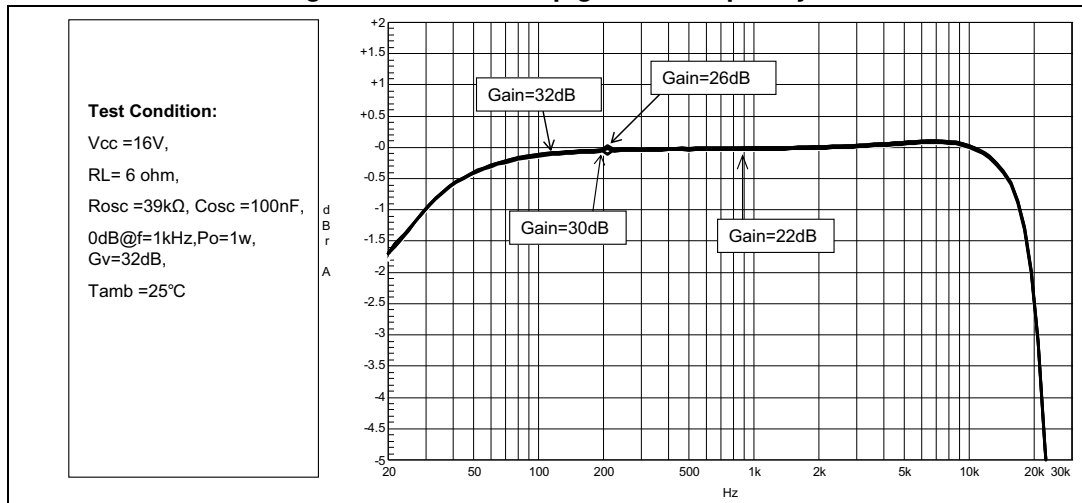

Figure 29. Current consumption vs. voltage on pin MUTE

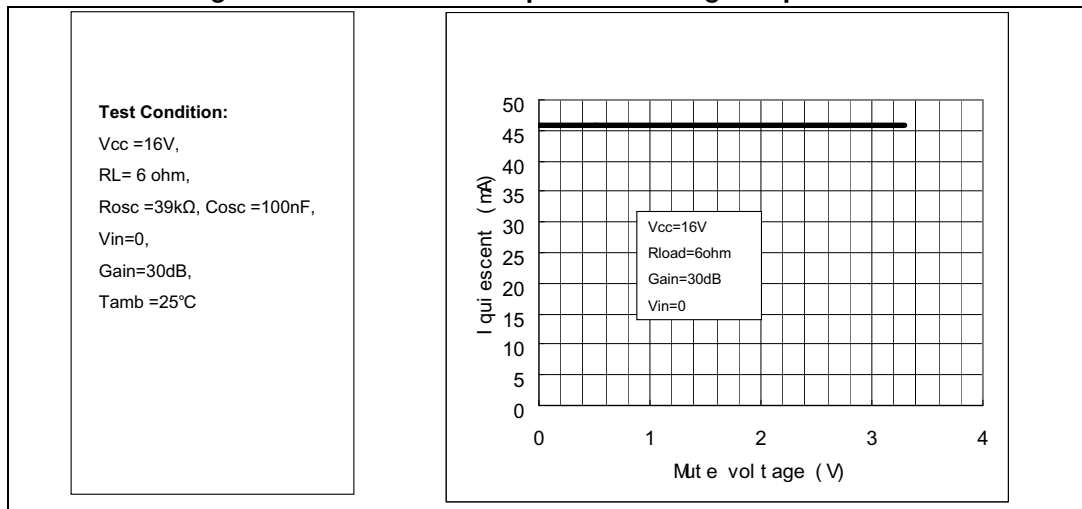

Figure 30. Attenuation vs. voltage on pin MUTE

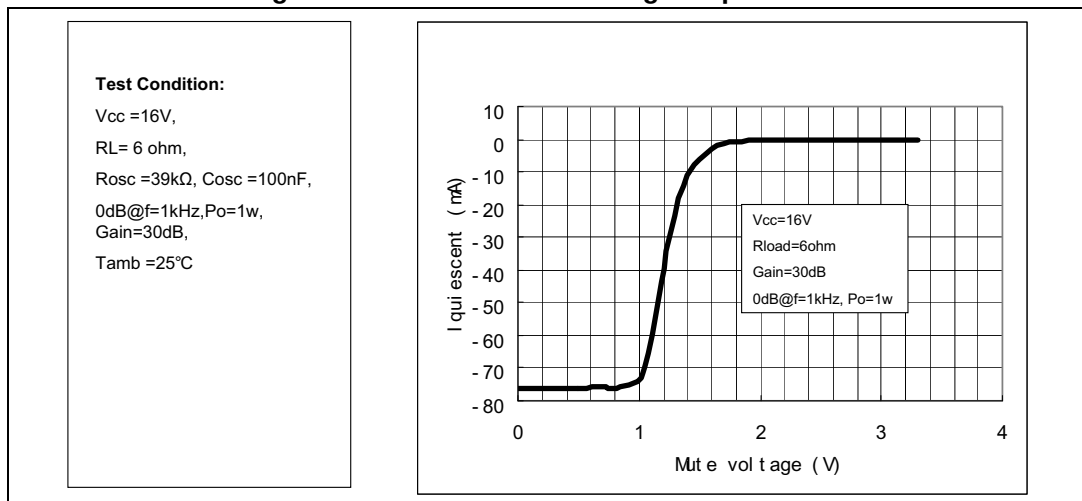

Figure 31. Current consumption vs. voltage on pin STBY

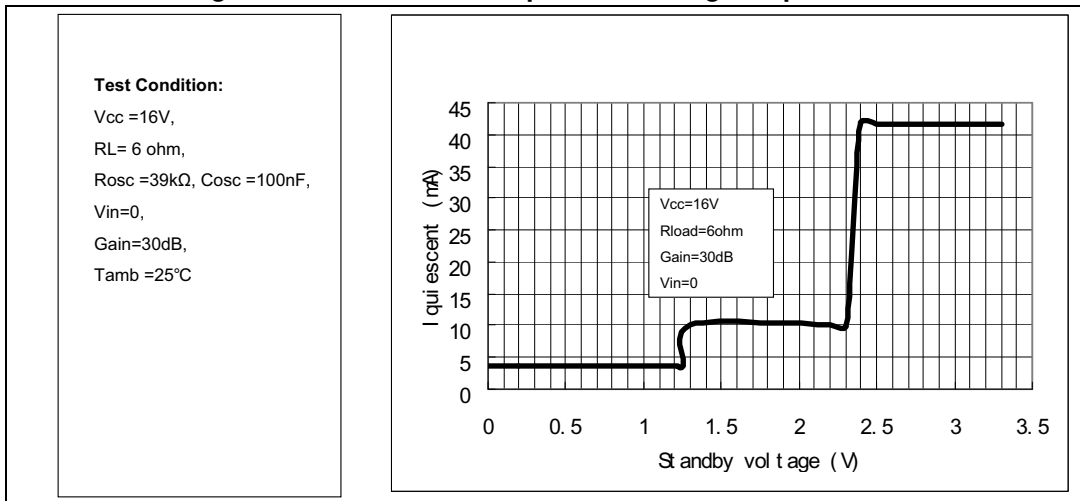
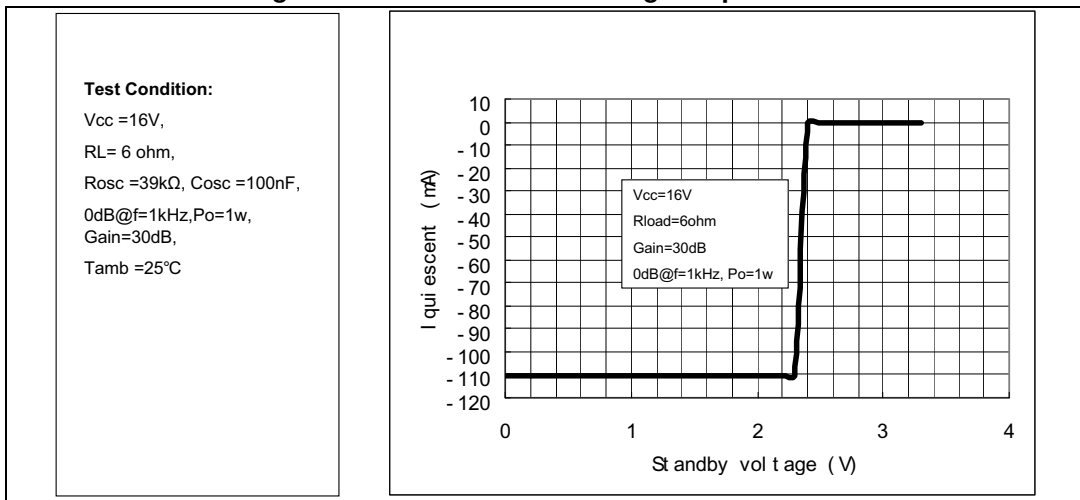

Figure 32. Attenuation vs. voltage on pin STBY



4.3 With 8 Ω load at V_{CC} = 18 V

Figure 33. Output power vs. supply voltage

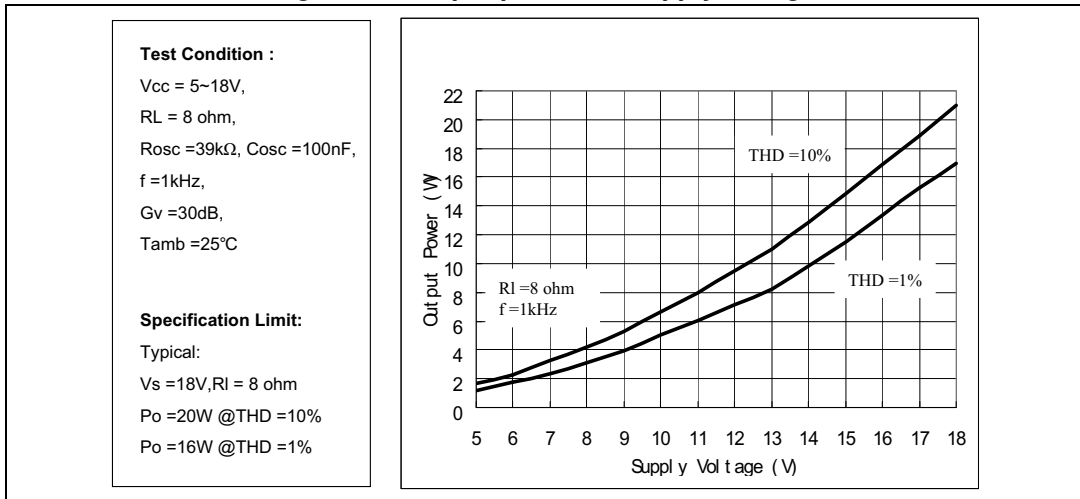

Figure 34. THD vs. output power (1 kHz)

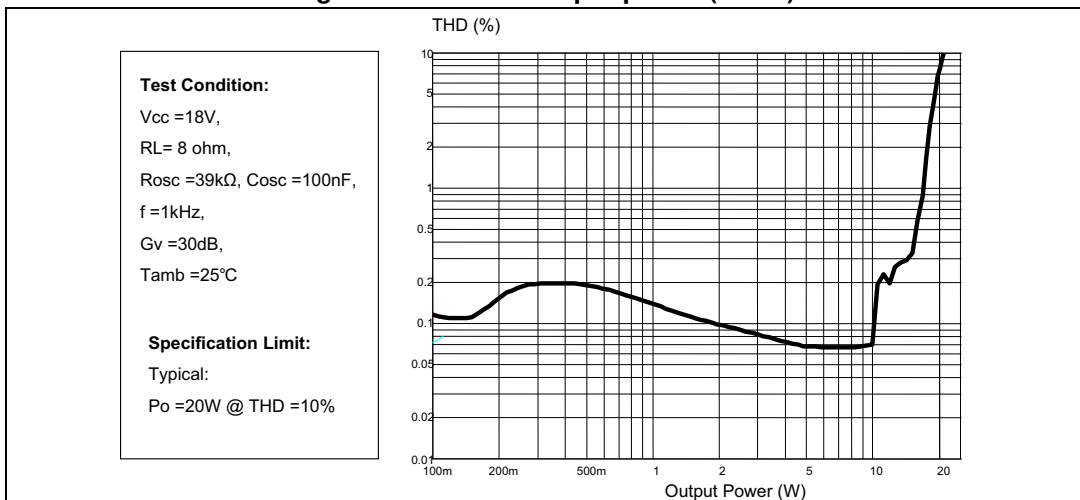

Figure 35. THD vs. output power (100 Hz)

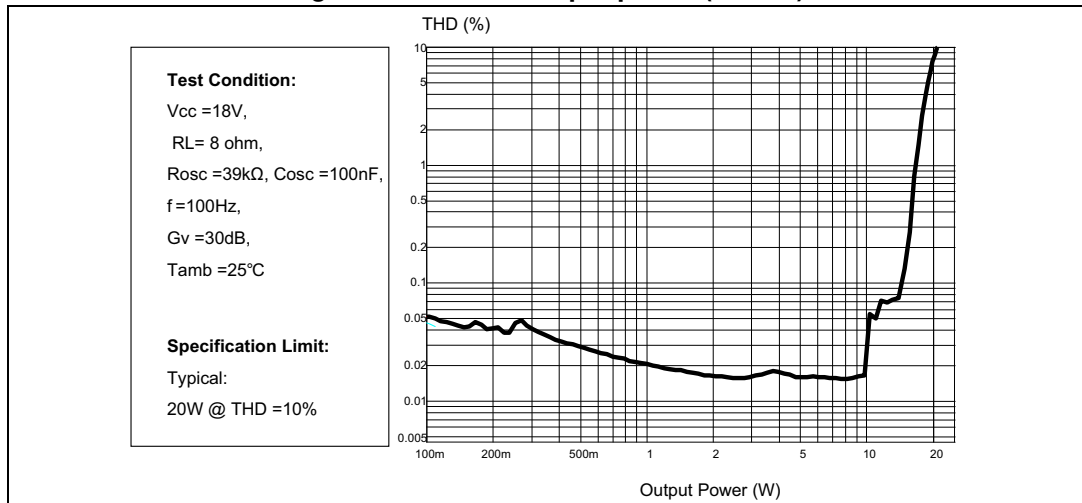

Figure 36. THD vs. frequency

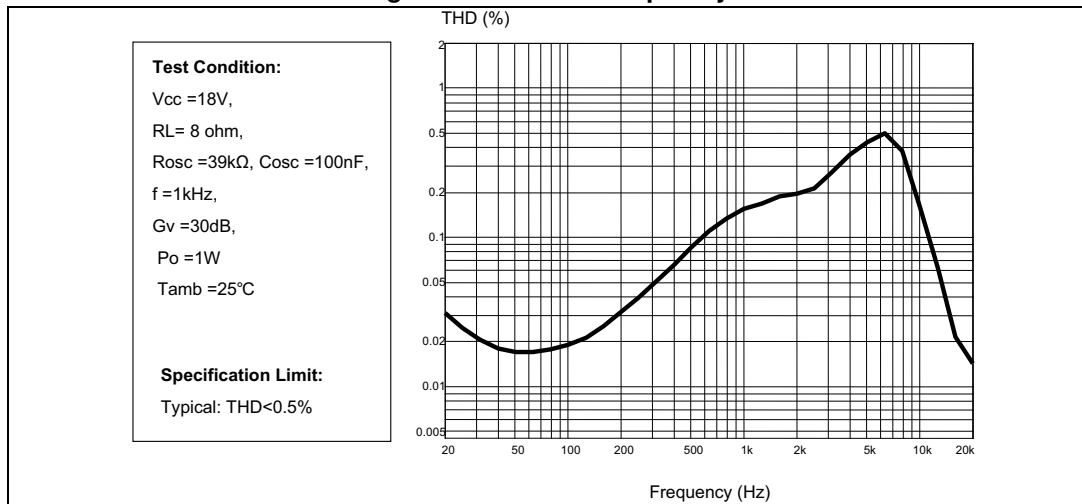

Figure 37. Frequency response

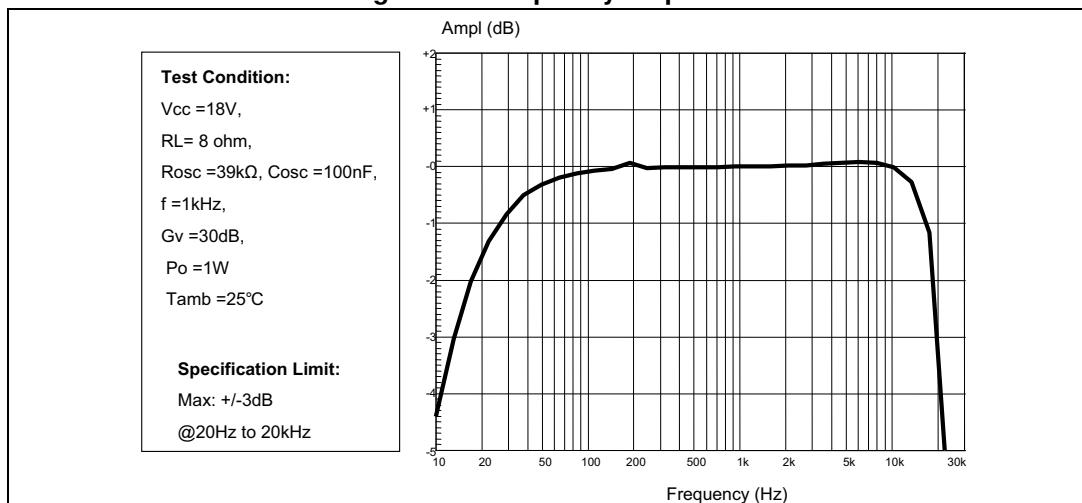

Figure 38. Crosstalk vs. frequency

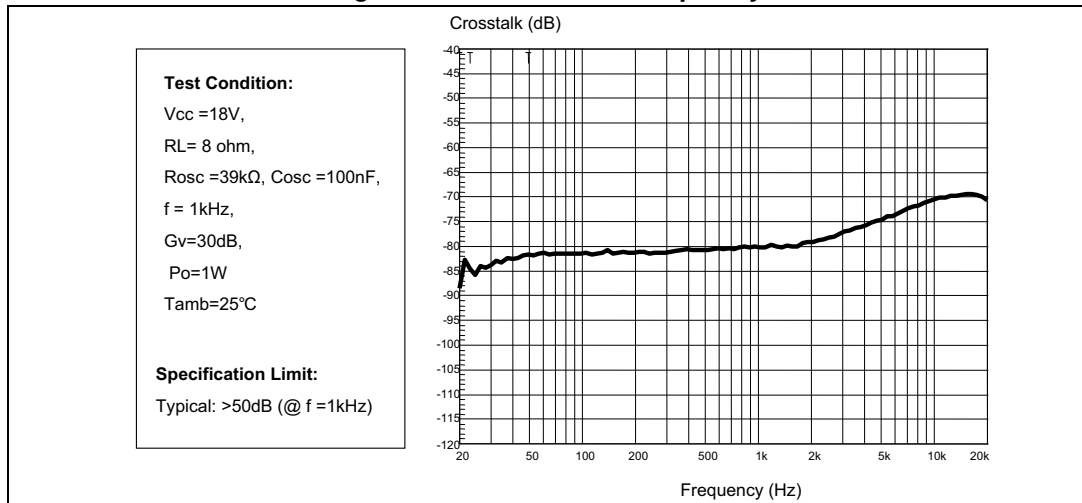

Figure 39. FFT (0 dB)

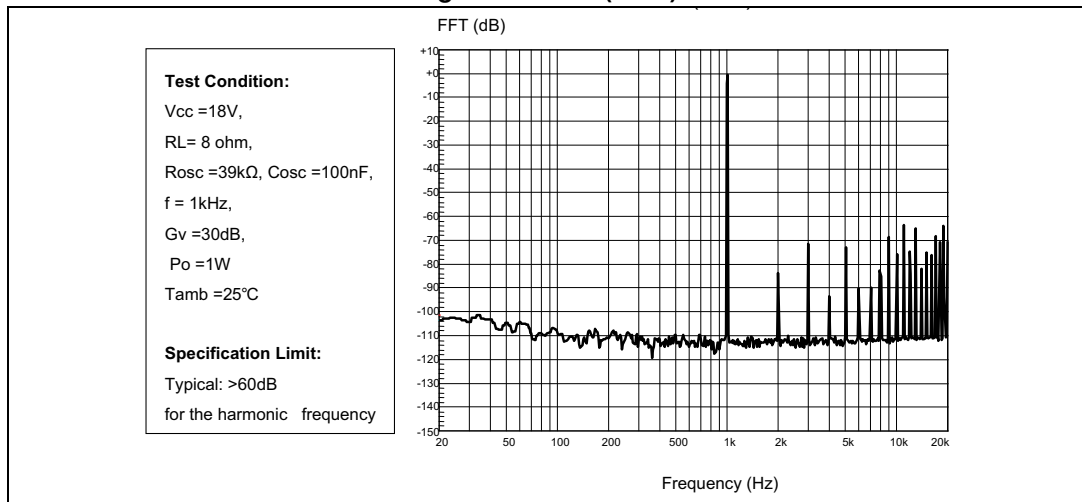

Figure 40. FFT (-60 dB)

