



Chipsmall Limited consists of a professional team with an average of over 10 year of expertise in the distribution of electronic components. Based in Hongkong, we have already established firm and mutual-benefit business relationships with customers from,Europe,America and south Asia,supplying obsolete and hard-to-find components to meet their specific needs.

With the principle of “Quality Parts,Customers Priority,Honest Operation,and Considerate Service”,our business mainly focus on the distribution of electronic components. Line cards we deal with include Microchip,ALPS,ROHM,Xilinx,Pulse,ON,Everlight and Freescale. Main products comprise IC,Modules,Potentiometer,IC Socket,Relay,Connector.Our parts cover such applications as commercial,industrial, and automotives areas.

We are looking forward to setting up business relationship with you and hope to provide you with the best service and solution. Let us make a better world for our industry!



Contact us

Tel: +86-755-8981 8866 Fax: +86-755-8427 6832

Email & Skype: info@chipsmall.com Web: www.chipsmall.com

Address: A1208, Overseas Decoration Building, #122 Zhenhua RD., Futian, Shenzhen, China



DATA SHEET

TDA8542TS

2 × 0.7 W BTL audio amplifier

Product specification
Supersedes data of 1997 Nov 17

1998 Mar 25



2 × 0.7 W BTL audio amplifier**TDA8542TS****FEATURES**

- Flexibility in use
- Few external components
- Low saturation voltage of output stage
- Gain can be fixed with external resistors
- Standby mode controlled by CMOS compatible levels
- Low standby current
- No switch-on/switch-off plops
- High supply voltage ripple rejection
- Protected against electrostatic discharge
- Outputs short-circuit safe to ground, V_{CC} and across the load
- Thermally protected.

GENERAL DESCRIPTION

The TDA8542TS is a two channel audio power amplifier for an output power of 2×0.7 W with a 16Ω load at a 5 V supply. At a low supply voltage of 3.3 V an output power of 0.6 W with an 8Ω load can be obtained. The circuit contains two Bridge-Tied Load (BTL) amplifiers with a complementary PNP-NPN output stage and standby/mute logic. The TDA8542TS is available in a SSOP20 package.

APPLICATIONS

- Portable consumer products
- Personal computers
- Motor-driver (servo).

QUICK REFERENCE DATA

SYMBOL	PARAMETER	CONDITIONS	MIN.	TYP.	MAX.	UNIT
V_{CC}	supply voltage		2.2	5	18	V
I_q	quiescent current	$V_{CC} = 5$ V	–	15	22	mA
I_{stb}	standby current		–	–	10	μ A
P_o	output power	THD = 10%; $R_L = 8 \Omega$; $V_{CC} = 3.3$ V	0.45	0.55	–	W
		THD = 10%; $R_L = 16 \Omega$; $V_{CC} = 5$ V	0.6	0.7	–	W
THD	total harmonic distortion	$P_o = 0.4$ W	–	0.15	–	%
SVRR	supply voltage ripple rejection		50	–	–	dB

ORDERING INFORMATION

TYPE NUMBER	PACKAGE		
	NAME	DESCRIPTION	VERSION
TDA8542TS	SSOP20	plastic shrink small outline package; 20 leads; body width 4.4 mm	SOT266-1

2 × 0.7 W BTL audio amplifier

TDA8542TS

BLOCK DIAGRAM

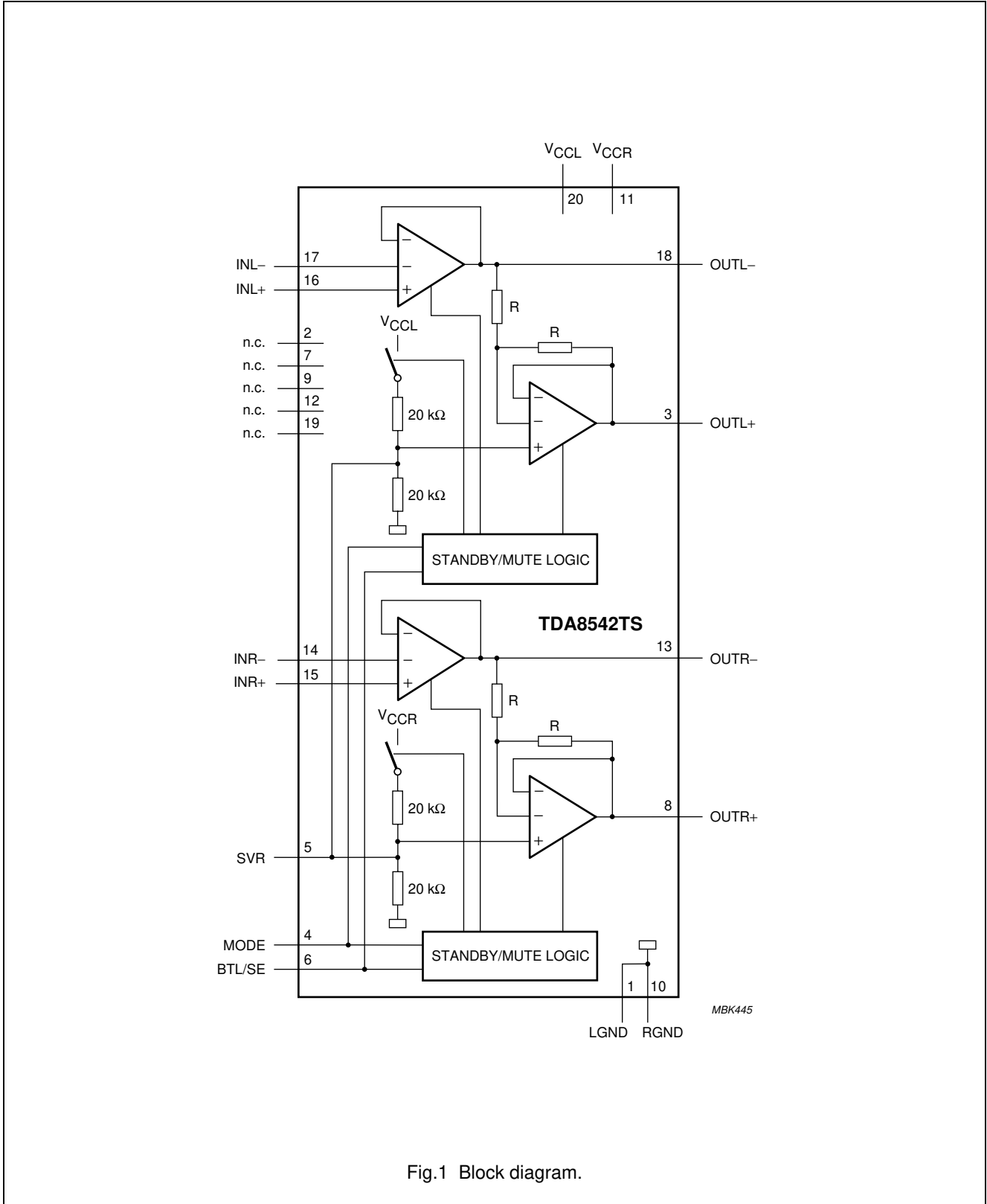

Fig.1 Block diagram.

2 × 0.7 W BTL audio amplifier

TDA8542TS

PINNING

SYMBOL	PIN	DESCRIPTION
LGND	1	ground, left channel
n.c.	2	not connected
OUTL+	3	positive loudspeaker terminal, left channel
MODE	4	operating mode select (standby, mute, operating)
SVR	5	half supply voltage, decoupling ripple rejection
BTL/SE	6	BTL loudspeaker or SE headphone operation
n.c.	7	not connected
OUTR+	8	positive loudspeaker terminal, right channel
n.c.	9	not connected
RGND	10	ground, right channel
V _{CCR}	11	supply voltage, right channel
n.c.	12	not connected
OUTR-	13	negative loudspeaker terminal, right channel
INR-	14	negative input, right channel
INR+	15	positive input, right channel
INL+	16	positive input, left channel
INL-	17	negative input, left channel
OUTL-	18	negative loudspeaker terminal, left channel
n.c.	19	not connected
V _{CCL}	20	supply voltage, left channel

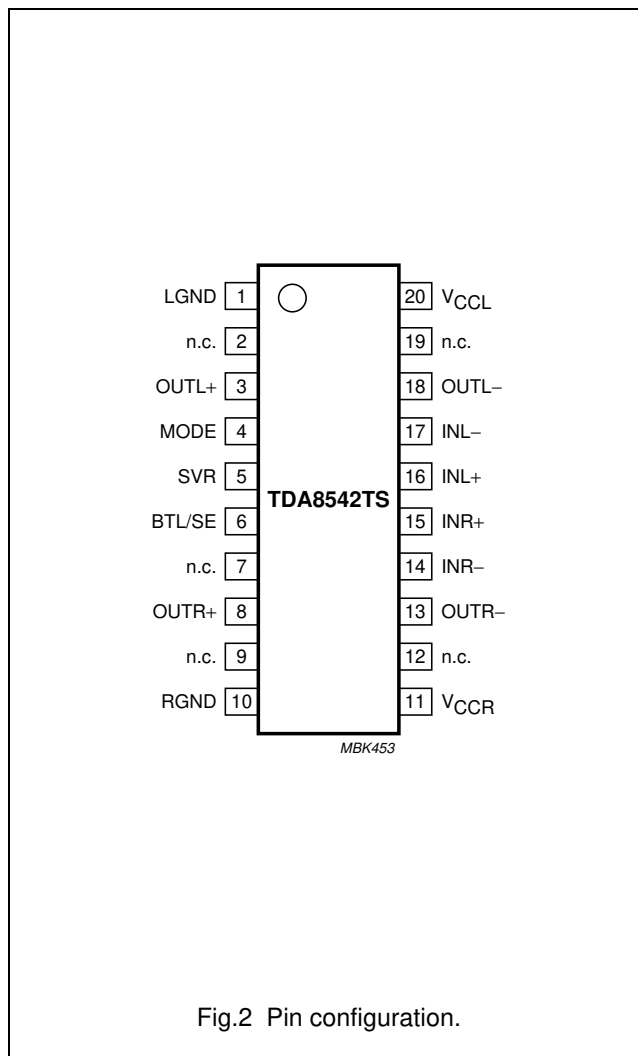

Fig.2 Pin configuration.

FUNCTIONAL DESCRIPTION

The TDA8542TS is a 2 × 0.7 W BTL audio power amplifier capable of delivering 2 × 0.7 W output power to a 16 Ω load at THD = 10% using a 5 V power supply. Using the MODE pin the device can be switched to standby and mute condition. The device is protected by an internal thermal shutdown protection mechanism. The gain can be set within a range from 6 to 30 dB by external feedback resistors.

Power amplifier

The power amplifier is a Bridge-Tied Load (BTL) amplifier with a complementary PNP-NPN output stage. The voltage loss on the positive supply line is the saturation voltage of a PNP power transistor, on the negative side the saturation voltage of a NPN power

transistor. The total voltage loss is <1 V and with a 5 V supply voltage and with a 16 Ω loudspeaker an output power of 0.7 W can be delivered.

Mode select pin

The device is in the standby mode (with a very low current consumption) if the voltage at the MODE pin is >(V_{CC} - 0.5 V), or if this pin is floating. At a MODE voltage level of less than 0.5 V the amplifier is fully operational. In the range between 1.5 V and V_{CC} - 1.5 V the amplifier is in mute condition. The mute condition is useful to suppress plop noise at the output caused by charging of the input capacitor.

2 × 0.7 W BTL audio amplifier

TDA8542TS

Headphone connection

A headphone can be connected to the amplifier using two coupling capacitors for each channel. The common GND pin of the headphone is connected to the ground of the amplifier (see Fig.13). In this case the BTL/SE pin must be either at a logic HIGH level or not connected at all.

The two coupling capacitors can be omitted if it is allowed to connect the common GND pin of the headphone jack

not to ground, but to a voltage level of $\frac{1}{2}V_{CC}$. See Fig.4 for the application diagram. In this case the BTL/SE pin must be either at a logic LOW level or connected to ground. If the BTL/SE pin is at a LOW level, the power amplifier for the positive loudspeaker terminal is always in mute condition.

LIMITING VALUES

In accordance with the Absolute Maximum Rating System (IEC 134).

SYMBOL	PARAMETER	CONDITIONS	MIN.	MAX.	UNIT
V_{CC}	supply voltage	operating	-0.3	+18	V
V_I	input voltage		-0.3	$V_{CC} + 0.3$	V
I_{ORM}	repetitive peak output current		-	1	A
T_{stg}	storage temperature	non-operating	-55	+150	°C
T_{amb}	operating ambient temperature		-40	+85	°C
V_{sc}	AC and DC short-circuit safe voltage		-	10	V
P_{tot}	total power dissipation		-	1.12	W

QUALITY SPECIFICATION

In accordance with "SNW-FQ-611-E".

THERMAL CHARACTERISTICS

SYMBOL	PARAMETER	CONDITIONS	VALUE	UNIT
$R_{th(j-a)}$	thermal resistance from junction to ambient	in free air	110 ⁽¹⁾	K/W

Note

1. See Section "Thermal design considerations".

Table 1 Maximum ambient temperature at different conditions

V_{CC} (V)	R_L (Ω)	P_o (W)	CONTINUOUS SINE WAVE DRIVEN	
			P_{max} (W)	$T_{amb(max)}$ (°C)
3.3	4	2×0.65	1.12	27 ⁽¹⁾
3.3	8	2×0.55	0.60	84
5	8	2×1.2	1.33	- ⁽¹⁾
5	16	2×0.70	0.80	62

Note

1. See Section "Thermal design considerations".

2 × 0.7 W BTL audio amplifier**TDA8542TS****DC CHARACTERISTICS**

$V_{CC} = 5\text{ V}$; $T_{amb} = 25\text{ °C}$; $R_L = 8\ \Omega$; $V_{MODE} = 0\text{ V}$; measured in test circuit Fig.3; unless otherwise specified.

SYMBOL	PARAMETER	CONDITIONS	MIN.	TYP.	MAX.	UNIT
V_{CC}	supply voltage	operating	2.2	5	18	V
I_q	quiescent current	$R_L = \infty$; note 1	–	15	22	mA
I_{stb}	standby current	$V_{MODE} = V_{CC}$	–	–	10	μA
V_O	DC output voltage	note 2	–	2.2	–	V
$ V_{OUT+} - V_{OUT-} $	differential output voltage offset		–	–	50	mV
I_{IN+}, I_{IN-}	input bias current		–	–	500	nA
V_{MODE}	input voltage mode select	operating	0	–	0.5	V
		mute	1.5	–	$V_{CC} - 1.5$	V
		standby	$V_{CC} - 0.5$	–	V_{CC}	V
I_{MODE}	input current mode select	$0 < V_{MODE} < V_{CC}$	–	–	20	μA
$V_{BTL/SE}$	input voltage BTL/SE pin	single-ended	0	–	0.6	V
		BTL	2	–	V_{CC}	V
$I_{BTL/SE}$	input current BTL/SE pin	$V_{BTL/SE} = 0$	–	–	100	μA

Notes

1. With a load connected at the outputs the quiescent current will increase, the maximum of this increase being equal to the DC output offset voltage divided by R_L .
2. The DC output voltage with respect to ground is approximately $\frac{1}{2}V_{CC}$.

2 × 0.7 W BTL audio amplifier**TDA8542TS****AC CHARACTERISTICS**

$V_{CC} = 5\text{ V}$; $T_{amb} = 25\text{ °C}$; $R_L = 8\ \Omega$; $f = 1\text{ kHz}$; $V_{MODE} = 0\text{ V}$; measured in test circuit Fig.3; unless otherwise specified.

SYMBOL	PARAMETER	CONDITIONS	MIN.	TYP.	MAX.	UNIT	
P_o	output power	at $V_{CC} = 5\text{ V}$					
		THD = 10%; $R_L = 8\ \Omega$	–	1.2	–	W	
		THD = 10%; $R_L = 16\ \Omega$	–	0.70	–	W	
		THD = 0.5%; $R_L = 8\ \Omega$	–	0.9	–	W	
		THD = 0.5%; $R_L = 16\ \Omega$	–	0.5	–	W	
		at $V_{CC} = 3.3\text{ V}$					
		THD = 10%; $R_L = 4\ \Omega$	–	0.65	–	W	
		THD = 10%; $R_L = 8\ \Omega$	–	0.55	–	W	
THD	total harmonic distortion	$P_o = 0.4\text{ W}$	–	0.15	0.3	%	
$G_{V(cl)}$	closed-loop voltage gain	note 1	6	–	30	dB	
$Z_{i(dif)}$	differential input impedance		–	100	–	k Ω	
$V_{n(o)}$	noise output voltage	note 2	–	–	100	μV	
SVRR	supply voltage ripple rejection	note 3	50	–	–	dB	
		note 4	40	–	–	dB	
$V_{o(mute)}$	output voltage in mute condition	note 5	–	–	200	μV	
α_{CS}	channel separation		40	–	–	dB	

Notes

- Gain of the amplifier is $2 \times \frac{R_2}{R_1}$ in test circuit of Fig.3.
- The noise output voltage is measured at the output in a frequency range from 20 Hz to 20 kHz (unweighted), with a source impedance of $R_S = 0\ \Omega$ at the input.
- Supply voltage ripple rejection is measured at the output, with a source impedance of $R_S = 0\ \Omega$ at the input. The ripple voltage is a sine wave with a frequency of 1 kHz and an amplitude of 100 mV (RMS), which is applied to the positive supply rail.
- Supply voltage ripple rejection is measured at the output, with a source impedance of $R_S = 0\ \Omega$ at the input. The ripple voltage is a sine wave with a frequency between 100 Hz and 20 kHz and an amplitude of 100 mV (RMS), which is applied to the positive supply rail.
- Output voltage in mute position is measured with a 1 V (RMS) input voltage in a bandwidth of 20 kHz, so including noise.

2 × 0.7 W BTL audio amplifier

TDA8542TS

TEST AND APPLICATION INFORMATION

Test conditions

Because the application can be either Bridge-Tied Load (BTL) or Single-Ended (SE), the curves of each application are shown separately.

The thermal resistance = 110 K/W for the SSOP20; the maximum sine wave power dissipation for $T_{amb} = 25\text{ °C}$ is:

$$\frac{150 - 25}{110} = 1.14\text{ W}$$

For $T_{amb} = 60\text{ °C}$ the maximum total power dissipation is:

$$\frac{150 - 60}{110} = 0.82\text{ W}$$

Thermal design considerations

The 'measured' thermal resistance of the IC package is highly dependent on the configuration and size of the application board. Data may not be comparable between different semiconductor manufacturers because the application boards and test methods are not (yet) standardized. Also, the thermal performance of packages for a specific application may be different than presented here, because the configuration of the application boards (copper area) may be different. Philips Semiconductors uses FR-4 type application boards with 1 oz copper traces with solder coating.

The SSOP package has improved thermal conductivity which reduces the thermal resistance. Using a practical PCB layout (see Fig.22) with wider copper tracks to the corner pins and just under the IC, the thermal resistance from junction to ambient can be reduced to approximately 80 K/W. For $T_{amb} = 60\text{ °C}$ the maximum total power

dissipation for this PCB layout is: $\frac{150 - 60}{80} = 1.12\text{ W}$

BTL application

$T_{amb} = 25\text{ °C}$ if not specially mentioned, $V_{CC} = 5\text{ V}$, $f = 1\text{ kHz}$, $R_L = 8\ \Omega$, $G_v = 20\text{ dB}$, audio band-pass 22 Hz to 22 kHz.

The BTL application diagram is illustrated in Fig.3.

The quiescent current has been measured without any load impedance. The total harmonic distortion as a

function of frequency was measured with a low-pass filter of 80 kHz. The value of capacitor C3 influences the behaviour of the SVRR at low frequencies, increasing the value of C3 increases the performance of the SVRR. The figure of the mode select voltage (V_{ms}) as a function of the supply voltage shows three areas; operating, mute and standby. It shows, that the DC-switching levels of the mute and standby respectively depends on the supply voltage level.

SE application

$T_{amb} = 25\text{ °C}$ if not specially mentioned, $V_{CC} = 7.5\text{ V}$, $f = 1\text{ kHz}$, $R_L = 4\ \Omega$, $G_v = 20\text{ dB}$, audio band-pass 22 Hz to 22 kHz.

The SE application diagram is illustrated in Fig.14.

If the BTL/SE pin (pin 6) is connected to ground, the positive outputs (pins 3 and 8) will be in mute condition with a DC level of $\frac{1}{2}V_{CC}$. When a headphone is used ($R_L \geq 25\ \Omega$) the SE headphone application can be used without output coupling capacitors; load between negative output and one of the positive outputs (e.g. pin 3) as common pin. The channel separation will be less in comparison with the application using a coupling capacitor connected to ground.

Increasing the value of electrolytic capacitor C3 will result in a better channel separation. Because the positive output is not designed for high output current ($2 \times I_o$) at low load impedance ($\leq 16\ \Omega$), the SE application with output capacitors connected to ground is advised. The capacitor value of C4/C5 in combination with the load impedance determines the low frequency behaviour. The THD as a function of frequency was measured using a low-pass filter of 80 kHz. The value of capacitor C3 influences the behaviour of the SVRR at low frequencies, increasing the value of C3 increases the performance of the SVRR.

General remark

The frequency characteristic can be adapted by connecting a small capacitor across the feedback resistor. To improve the immunity of HF radiation in radio circuit applications, a small capacitor can be connected in parallel with the feedback resistor (56 k Ω); this creates a low-pass filter.

2 × 0.7 W BTL audio amplifier

TDA8542TS

BTL APPLICATION

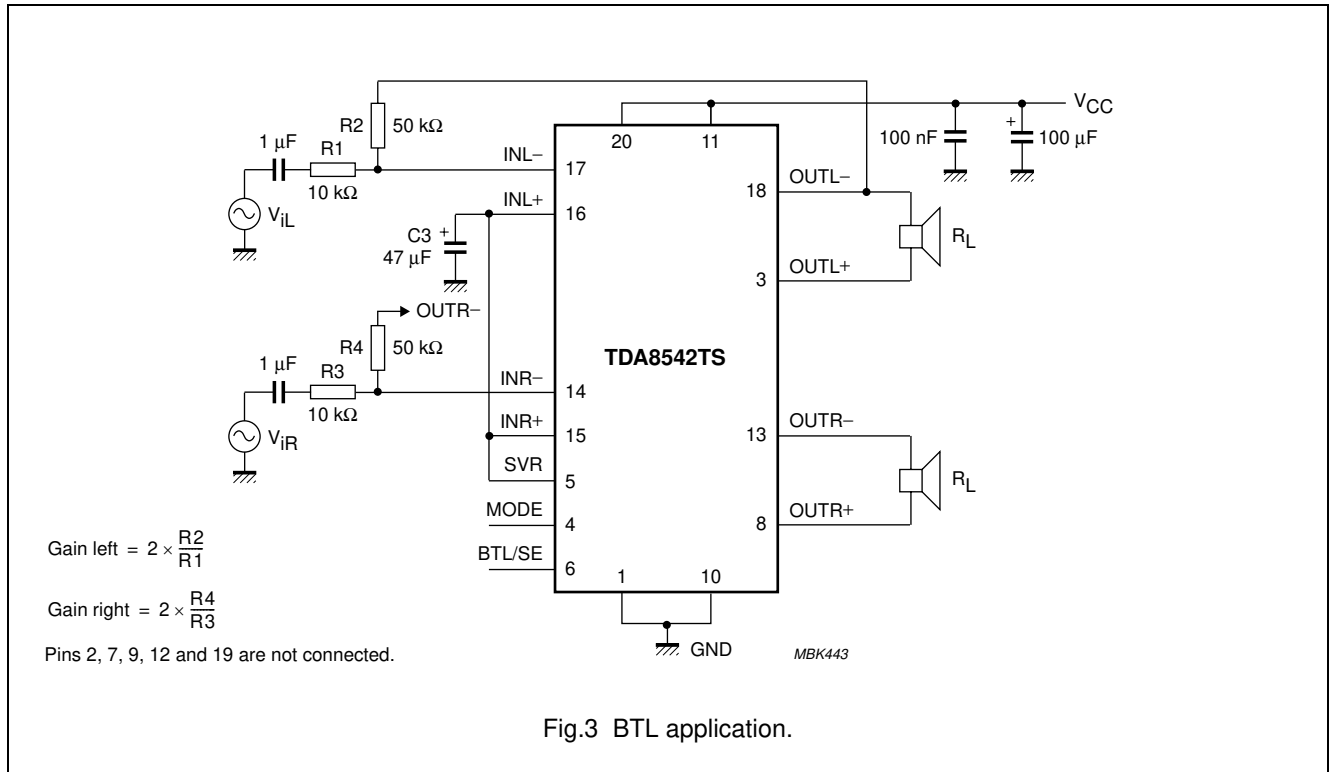

Fig.3 BTL application.

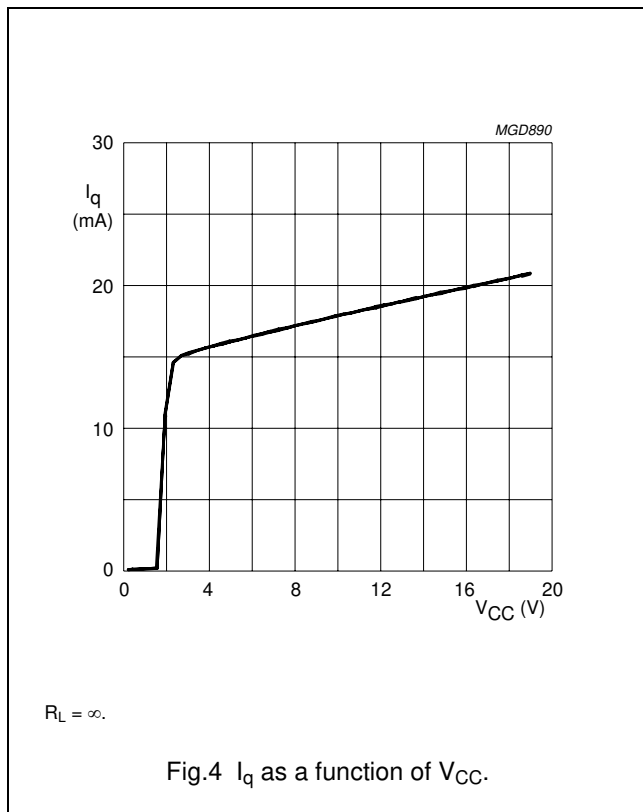

Fig.4 I_q as a function of V_{CC} .

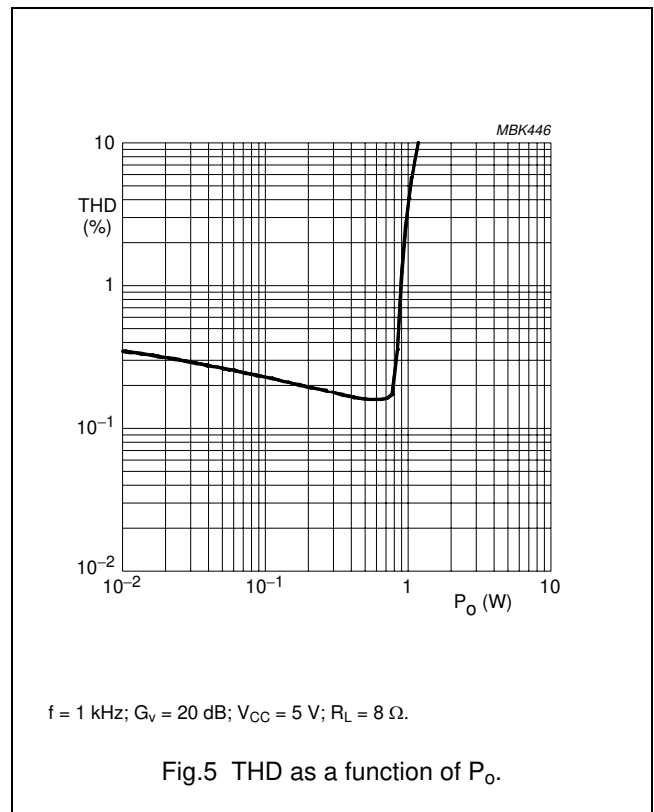
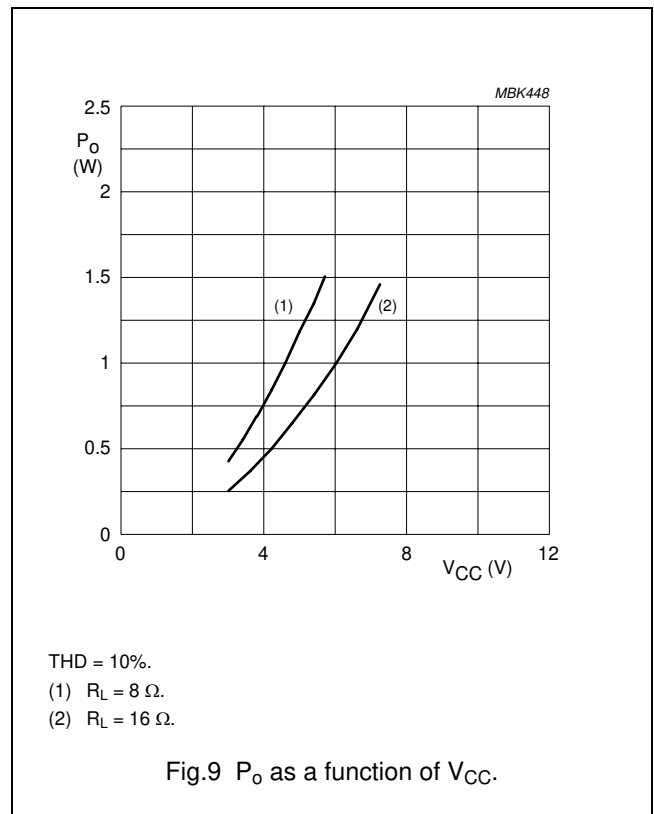
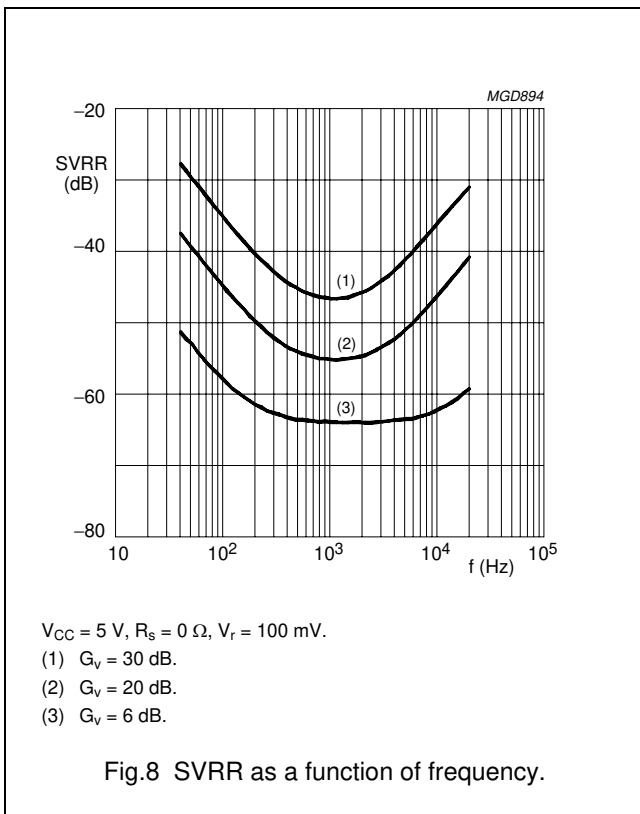
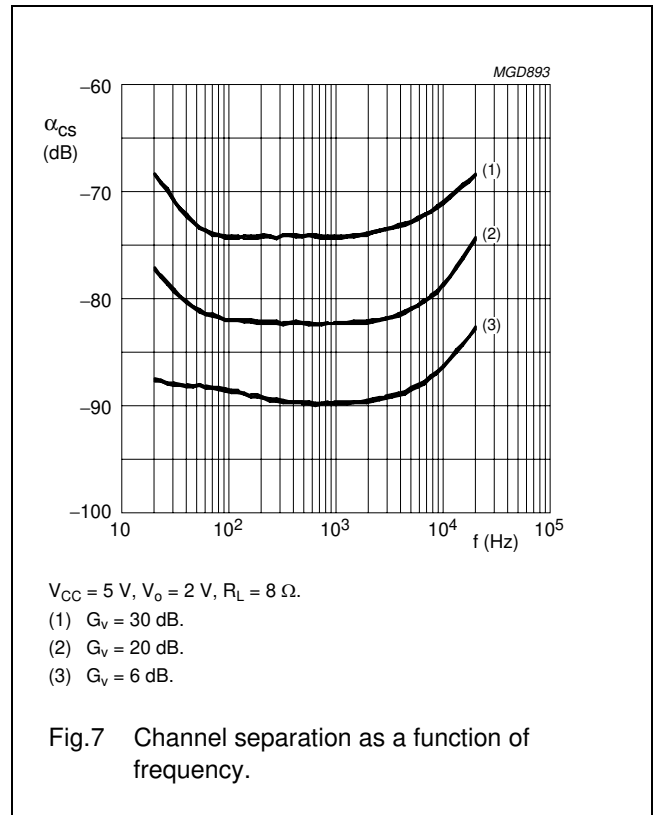
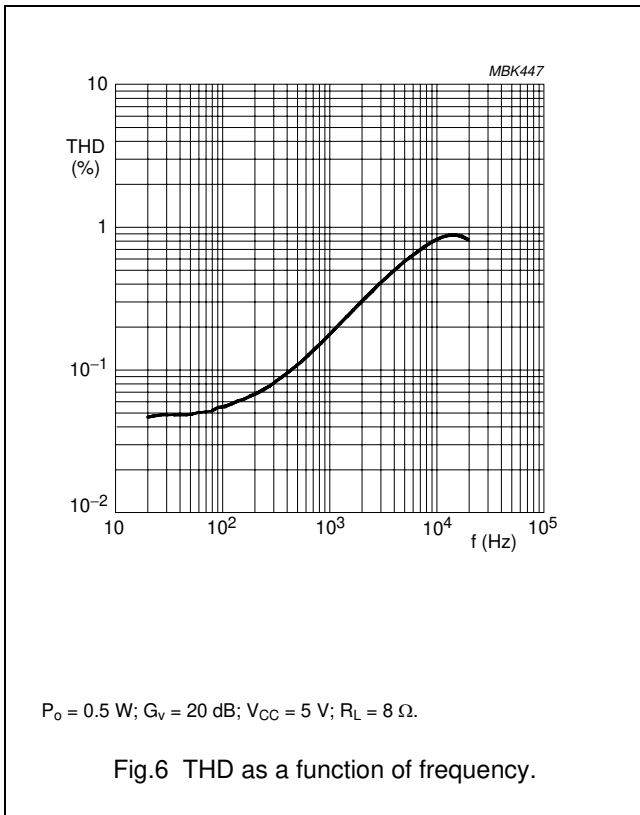

Fig.5 THD as a function of P_o .

2 × 0.7 W BTL audio amplifier

TDA8542TS



2 × 0.7 W BTL audio amplifier

TDA8542TS

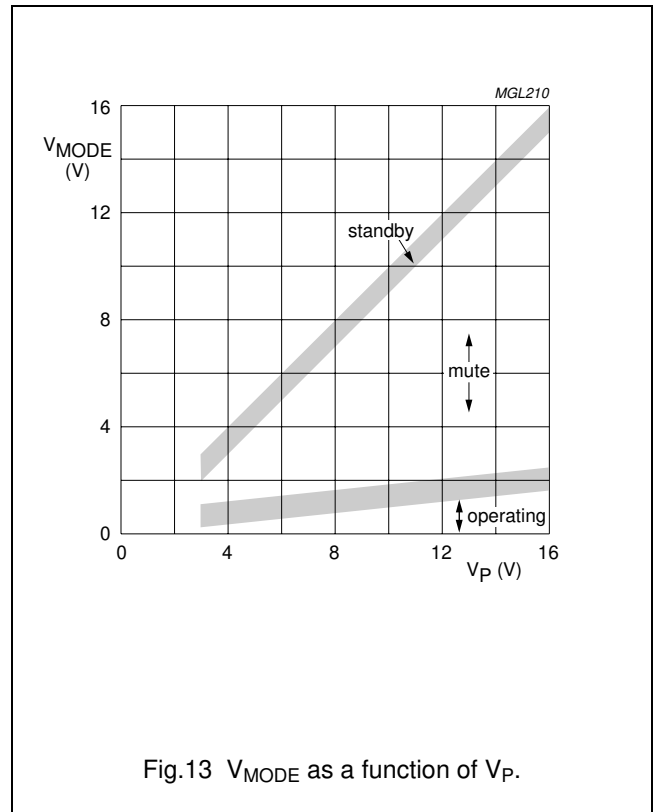
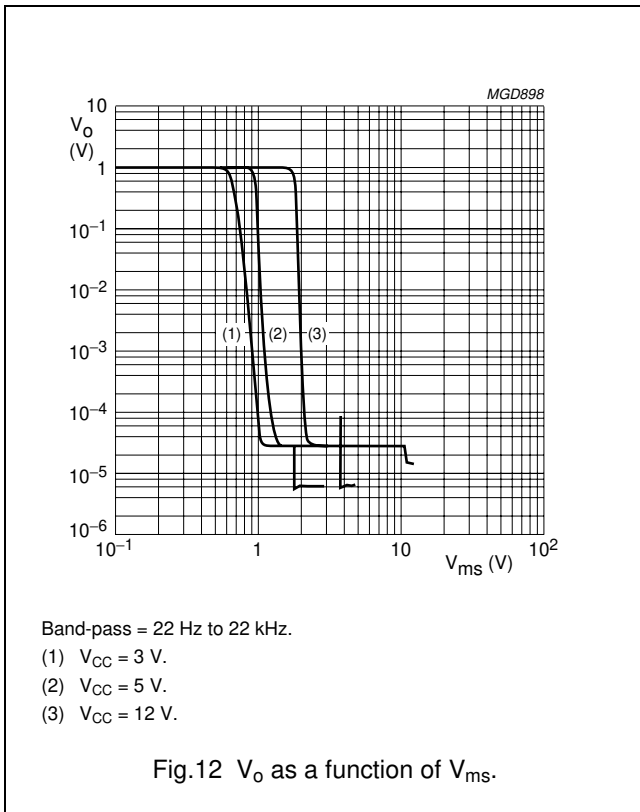
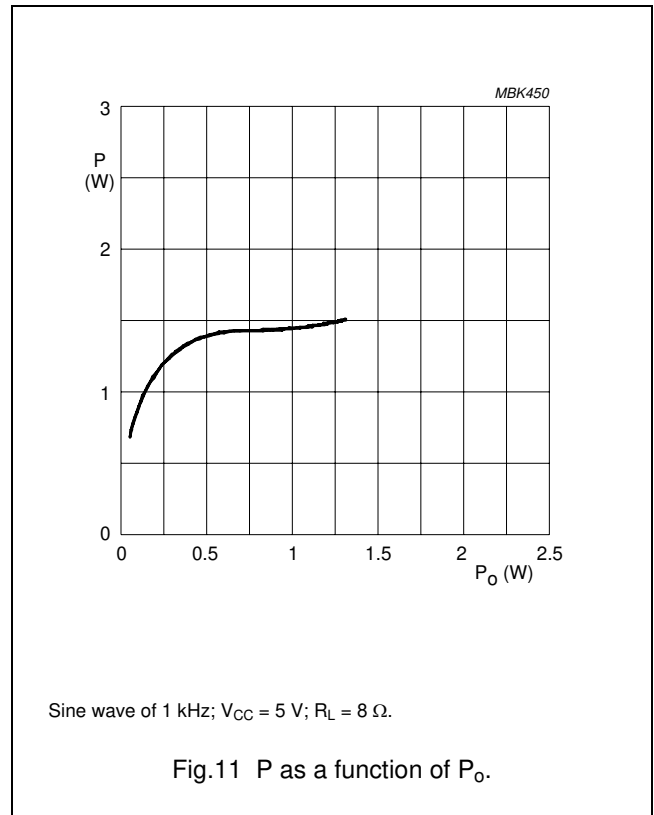
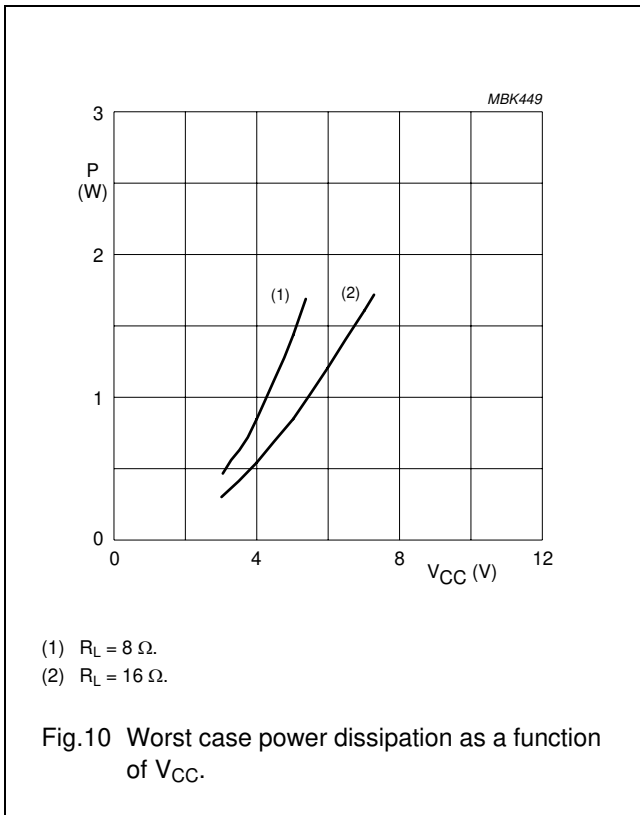

2 × 0.7 W BTL audio amplifier

TDA8542TS

SE APPLICATION

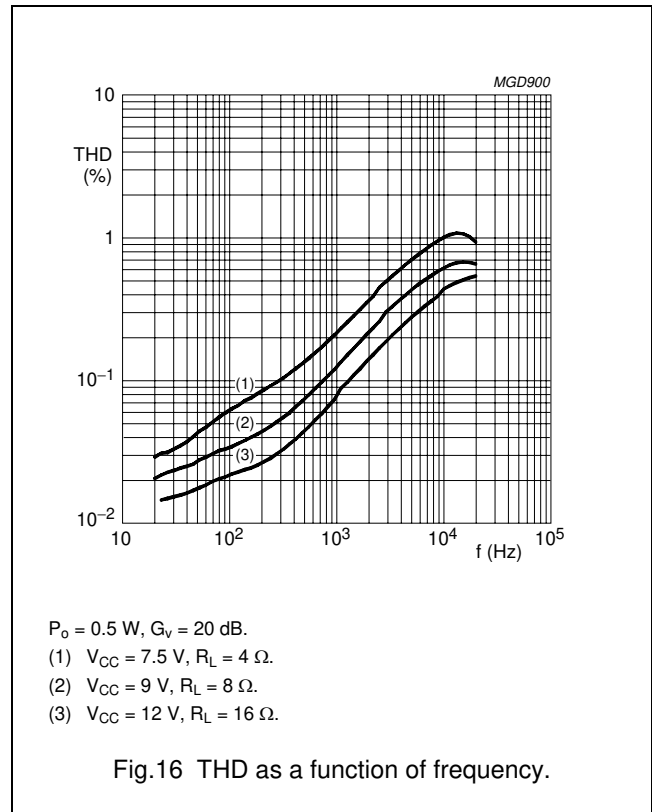
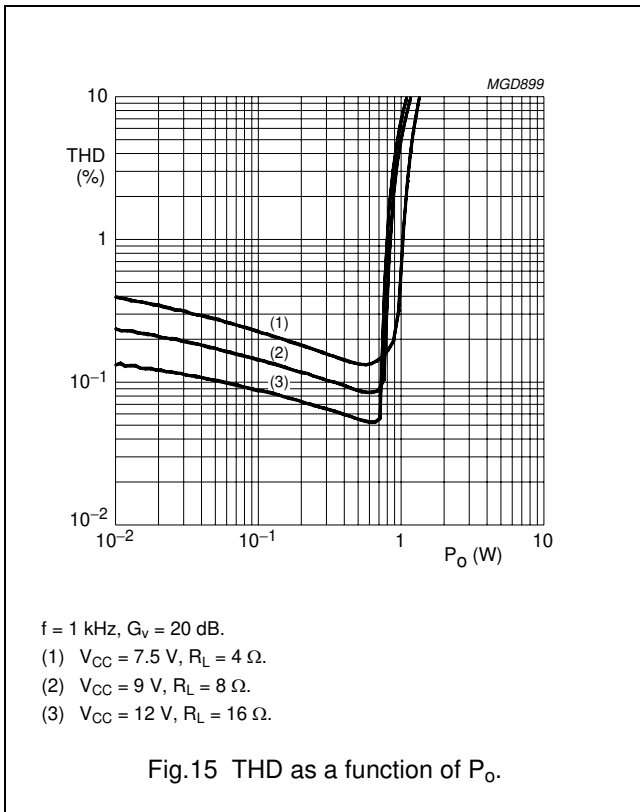
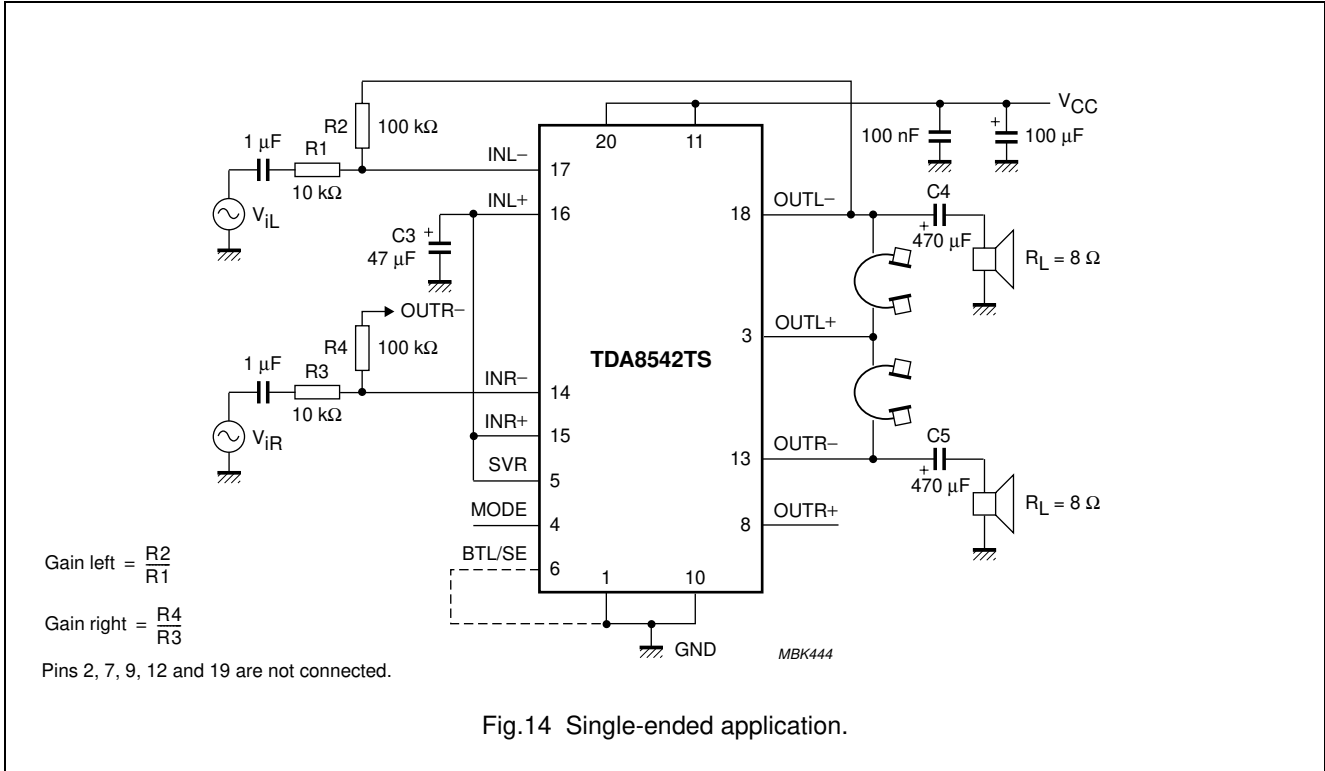

2 × 0.7 W BTL audio amplifier

TDA8542TS

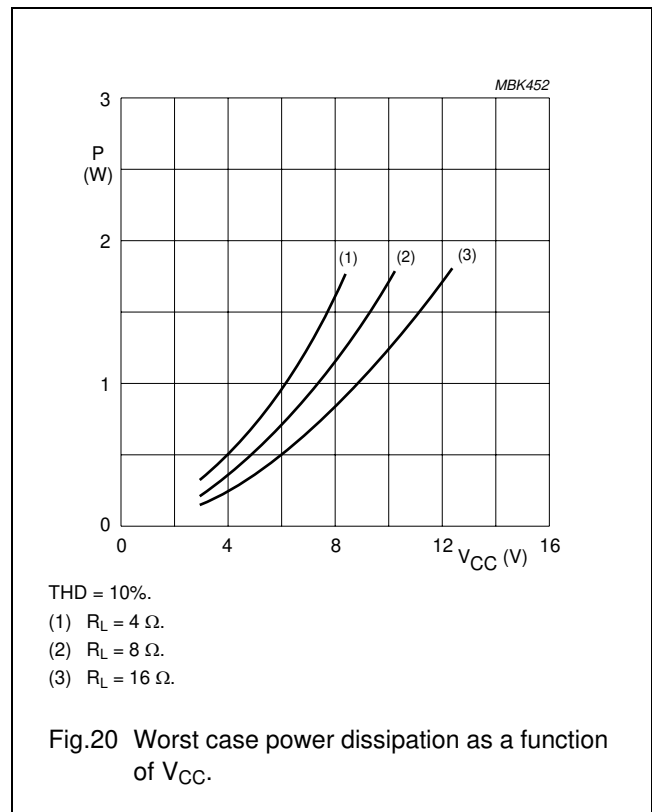
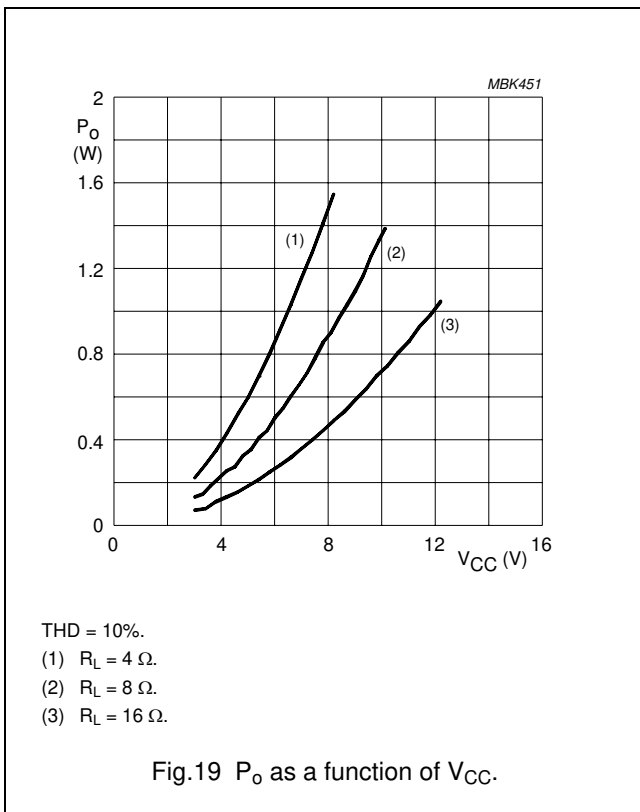
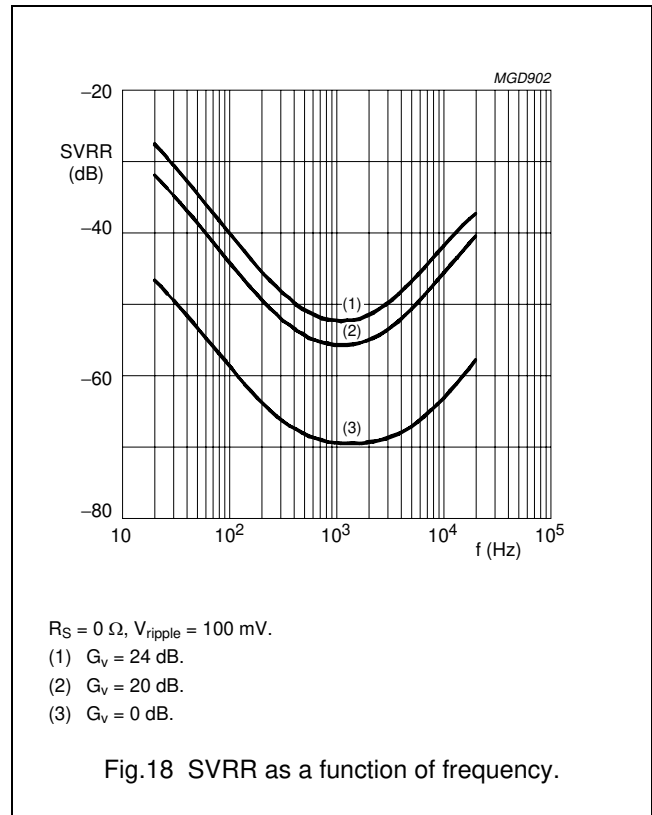
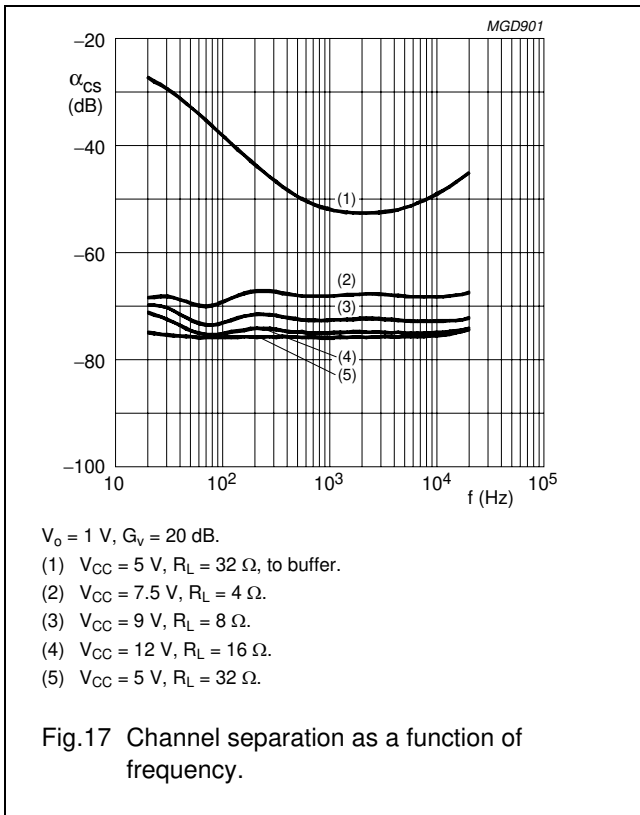

2 × 0.7 W BTL audio amplifier

TDA8542TS

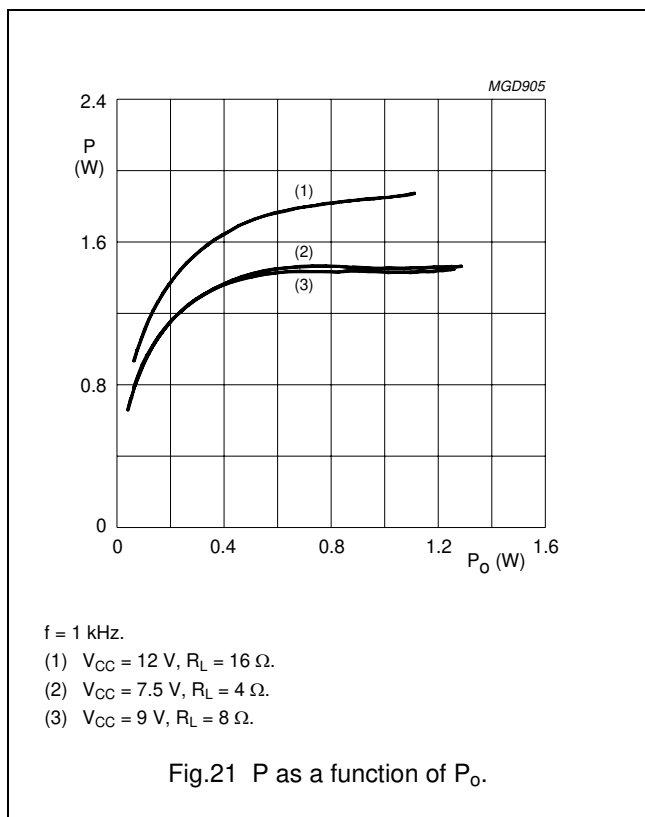

2 × 0.7 W BTL audio amplifier

TDA8542TS

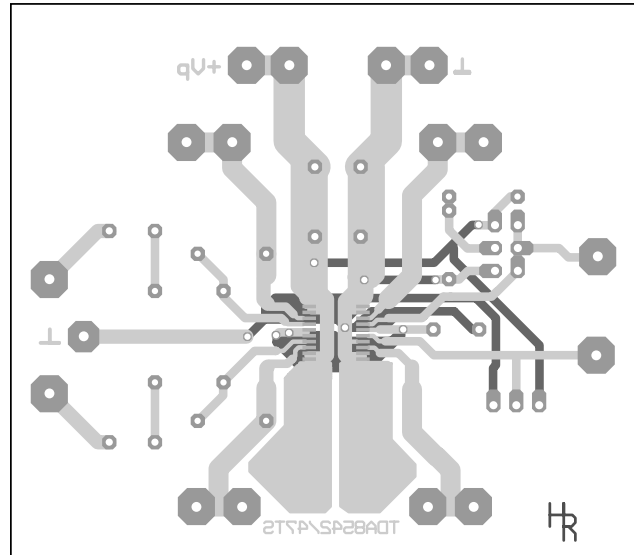

a. Top view copper layout.

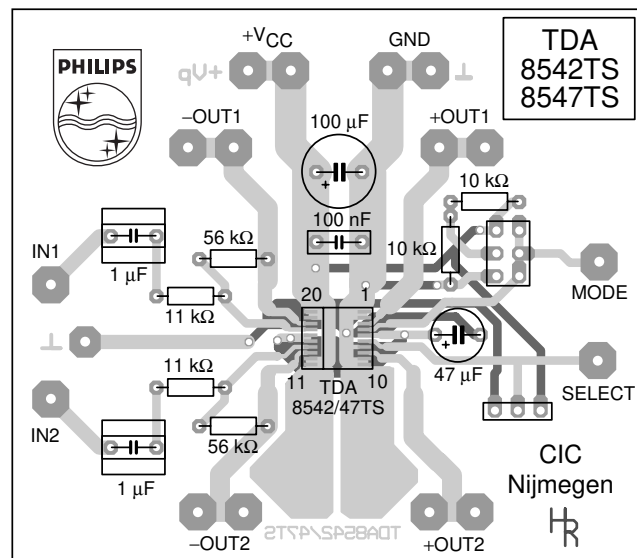

b. Top view components layout.

Fig.22 Printed-circuit board layout (BTL).

2 × 0.7 W BTL audio amplifier

TDA8542TS

PACKAGE OUTLINE

SSOP20: plastic shrink small outline package; 20 leads; body width 4.4 mm

SOT266-1

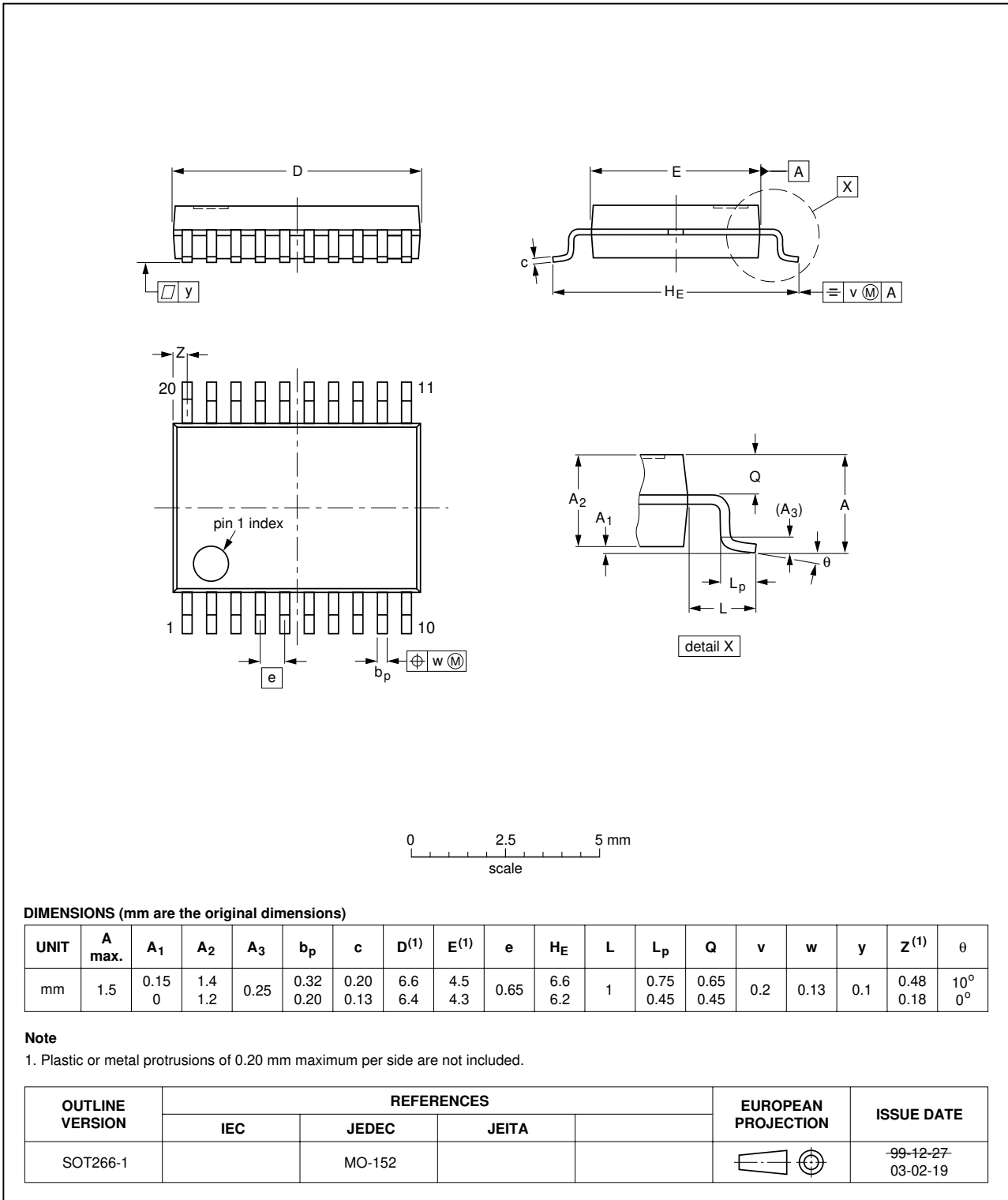

2 × 0.7 W BTL audio amplifier**TDA8542TS**

SOLDERING**Introduction**

There is no soldering method that is ideal for all IC packages. Wave soldering is often preferred when through-hole and surface mounted components are mixed on one printed-circuit board. However, wave soldering is not always suitable for surface mounted ICs, or for printed-circuits with high population densities. In these situations reflow soldering is often used.

This text gives a very brief insight to a complex technology. A more in-depth account of soldering ICs can be found in our "*IC Package Databook*" (order code 9398 652 90011).

Reflow soldering

Reflow soldering techniques are suitable for all SSOP packages.

Reflow soldering requires solder paste (a suspension of fine solder particles, flux and binding agent) to be applied to the printed-circuit board by screen printing, stencilling or pressure-syringe dispensing before package placement.

Several techniques exist for reflowing; for example, thermal conduction by heated belt. Dwell times vary between 50 and 300 seconds depending on heating method. Typical reflow temperatures range from 215 to 250 °C.

Preheating is necessary to dry the paste and evaporate the binding agent. Preheating duration: 45 minutes at 45 °C.

Wave soldering

Wave soldering is **not** recommended for SSOP packages. This is because of the likelihood of solder bridging due to closely-spaced leads and the possibility of incomplete solder penetration in multi-lead devices.

If wave soldering cannot be avoided, the following conditions must be observed:

- **A double-wave (a turbulent wave with high upward pressure followed by a smooth laminar wave) soldering technique should be used.**
- **The longitudinal axis of the package footprint must be parallel to the solder flow and must incorporate solder thieves at the downstream end.**

Even with these conditions, only consider wave soldering SSOP packages that have a body width of 4.4 mm, that is SSOP16 (SOT369-1) or SSOP20 (SOT266-1).

During placement and before soldering, the package must be fixed with a droplet of adhesive. The adhesive can be applied by screen printing, pin transfer or syringe dispensing. The package can be soldered after the adhesive is cured.

Maximum permissible solder temperature is 260 °C, and maximum duration of package immersion in solder is 10 seconds, if cooled to less than 150 °C within 6 seconds. Typical dwell time is 4 seconds at 250 °C.

A mildly-activated flux will eliminate the need for removal of corrosive residues in most applications.

Repairing soldered joints

Fix the component by first soldering two diagonally-opposite end leads. Use only a low voltage soldering iron (less than 24 V) applied to the flat part of the lead. Contact time must be limited to 10 seconds at up to 300 °C. When using a dedicated tool, all other leads can be soldered in one operation within 2 to 5 seconds between 270 and 320 °C.

2×0.7 W BTL audio amplifier

TDA8542TS

DATA SHEET STATUS

DOCUMENT STATUS ⁽¹⁾	PRODUCT STATUS ⁽²⁾	DEFINITION
Objective data sheet	Development	This document contains data from the objective specification for product development.
Preliminary data sheet	Qualification	This document contains data from the preliminary specification.
Product data sheet	Production	This document contains the product specification.

Notes

1. Please consult the most recently issued document before initiating or completing a design.
2. The product status of device(s) described in this document may have changed since this document was published and may differ in case of multiple devices. The latest product status information is available on the Internet at URL <http://www.nxp.com>.

DISCLAIMERS

Limited warranty and liability — Information in this document is believed to be accurate and reliable. However, NXP Semiconductors does not give any representations or warranties, expressed or implied, as to the accuracy or completeness of such information and shall have no liability for the consequences of use of such information.

In no event shall NXP Semiconductors be liable for any indirect, incidental, punitive, special or consequential damages (including - without limitation - lost profits, lost savings, business interruption, costs related to the removal or replacement of any products or rework charges) whether or not such damages are based on tort (including negligence), warranty, breach of contract or any other legal theory.

Notwithstanding any damages that customer might incur for any reason whatsoever, NXP Semiconductors' aggregate and cumulative liability towards customer for the products described herein shall be limited in accordance with the *Terms and conditions of commercial sale* of NXP Semiconductors.

Right to make changes — NXP Semiconductors reserves the right to make changes to information published in this document, including without limitation specifications and product descriptions, at any time and without notice. This document supersedes and replaces all information supplied prior to the publication hereof.

Suitability for use — NXP Semiconductors products are not designed, authorized or warranted to be suitable for use in life support, life-critical or safety-critical systems or equipment, nor in applications where failure or malfunction of an NXP Semiconductors product can reasonably be expected to result in personal injury, death or severe

property or environmental damage. NXP Semiconductors accepts no liability for inclusion and/or use of NXP Semiconductors products in such equipment or applications and therefore such inclusion and/or use is at the customer's own risk.

Applications — Applications that are described herein for any of these products are for illustrative purposes only. NXP Semiconductors makes no representation or warranty that such applications will be suitable for the specified use without further testing or modification.

Customers are responsible for the design and operation of their applications and products using NXP Semiconductors products, and NXP Semiconductors accepts no liability for any assistance with applications or customer product design. It is customer's sole responsibility to determine whether the NXP Semiconductors product is suitable and fit for the customer's applications and products planned, as well as for the planned application and use of customer's third party customer(s). Customers should provide appropriate design and operating safeguards to minimize the risks associated with their applications and products.

NXP Semiconductors does not accept any liability related to any default, damage, costs or problem which is based on any weakness or default in the customer's applications or products, or the application or use by customer's third party customer(s). Customer is responsible for doing all necessary testing for the customer's applications and products using NXP Semiconductors products in order to avoid a default of the applications and the products or of the application or use by customer's third party customer(s). NXP does not accept any liability in this respect.

2 × 0.7 W BTL audio amplifier**TDA8542TS**

Limiting values — Stress above one or more limiting values (as defined in the Absolute Maximum Ratings System of IEC 60134) will cause permanent damage to the device. Limiting values are stress ratings only and (proper) operation of the device at these or any other conditions above those given in the Recommended operating conditions section (if present) or the Characteristics sections of this document is not warranted. Constant or repeated exposure to limiting values will permanently and irreversibly affect the quality and reliability of the device.

Terms and conditions of commercial sale — NXP Semiconductors products are sold subject to the general terms and conditions of commercial sale, as published at <http://www.nxp.com/profile/terms>, unless otherwise agreed in a valid written individual agreement. In case an individual agreement is concluded only the terms and conditions of the respective agreement shall apply. NXP Semiconductors hereby expressly objects to applying the customer's general terms and conditions with regard to the purchase of NXP Semiconductors products by customer.

No offer to sell or license — Nothing in this document may be interpreted or construed as an offer to sell products that is open for acceptance or the grant, conveyance or implication of any license under any copyrights, patents or other industrial or intellectual property rights.

Export control — This document as well as the item(s) described herein may be subject to export control regulations. Export might require a prior authorization from national authorities.

Quick reference data — The Quick reference data is an extract of the product data given in the Limiting values and Characteristics sections of this document, and as such is not complete, exhaustive or legally binding.

Non-automotive qualified products — Unless this data sheet expressly states that this specific NXP Semiconductors product is automotive qualified, the product is not suitable for automotive use. It is neither qualified nor tested in accordance with automotive testing or application requirements. NXP Semiconductors accepts no liability for inclusion and/or use of non-automotive qualified products in automotive equipment or applications.

In the event that customer uses the product for design-in and use in automotive applications to automotive specifications and standards, customer (a) shall use the product without NXP Semiconductors' warranty of the product for such automotive applications, use and specifications, and (b) whenever customer uses the product for automotive applications beyond NXP Semiconductors' specifications such use shall be solely at customer's own risk, and (c) customer fully indemnifies NXP Semiconductors for any liability, damages or failed product claims resulting from customer design and use of the product for automotive applications beyond NXP Semiconductors' standard warranty and NXP Semiconductors' product specifications.

NXP Semiconductors

provides High Performance Mixed Signal and Standard Product solutions that leverage its leading RF, Analog, Power Management, Interface, Security and Digital Processing expertise

Customer notification

This data sheet was changed to reflect the new company name NXP Semiconductors, including new legal definitions and disclaimers. No changes were made to the technical content, except for package outline drawings which were updated to the latest version.

Contact information

For additional information please visit: <http://www.nxp.com>

For sales offices addresses send e-mail to: salesaddresses@nxp.com

© NXP B.V. 2010

All rights are reserved. Reproduction in whole or in part is prohibited without the prior written consent of the copyright owner.

The information presented in this document does not form part of any quotation or contract, is believed to be accurate and reliable and may be changed without notice. No liability will be accepted by the publisher for any consequence of its use. Publication thereof does not convey nor imply any license under patent- or other industrial or intellectual property rights.

Printed in The Netherlands

545102/25/02/pp20

Date of release: 1998 Mar 25

Document order number: 9397 750 03351