



Chipsmall Limited consists of a professional team with an average of over 10 year of expertise in the distribution of electronic components. Based in Hongkong, we have already established firm and mutual-benefit business relationships with customers from,Europe,America and south Asia,supplying obsolete and hard-to-find components to meet their specific needs.

With the principle of “Quality Parts,Customers Priority,Honest Operation,and Considerate Service”,our business mainly focus on the distribution of electronic components. Line cards we deal with include Microchip,ALPS,ROHM,Xilinx,Pulse,ON,Everlight and Freescale. Main products comprise IC,Modules,Potentiometer,IC Socket,Relay,Connector.Our parts cover such applications as commercial,industrial, and automotives areas.

We are looking forward to setting up business relationship with you and hope to provide you with the best service and solution. Let us make a better world for our industry!



Contact us

Tel: +86-755-8981 8866 Fax: +86-755-8427 6832

Email & Skype: info@chipsmall.com Web: www.chipsmall.com

Address: A1208, Overseas Decoration Building, #122 Zhenhua RD., Futian, Shenzhen, China



DATA SHEET

TDA9809M

Single standard multimedia IF-PLL
and FM radio demodulator

Preliminary specification
File under Integrated Circuits, IC02

1998 Jan 08

Single standard multimedia IF-PLL and FM radio demodulator

TDA9809M

FEATURES

- 5 V supply voltage
- Applicable at Intermediate Frequencies (IFs) of 38.9 and 45.75 MHz
- Gain controlled wideband Video IF (VIF) amplifier (AC-coupled)
- True synchronous demodulation with active carrier regeneration (very linear demodulation, good intermodulation figures, reduced harmonics, excellent pulse response)
- Robustness for over-modulation better than 105% due to PLL bandwidth control for negative modulation standards
- VIF AGC (Automatic Gain Control) detector for gain control, operating as peak sync detector for negative modulation standards
- Tuner AGC with adjustable TakeOver Point (TOP)
- AFC (Automatic Frequency Control) detector without extra reference circuit
- AC-coupled limiting amplifier for sound intercarrier signal
- Alignment-free FM PLL (Phase-Locked Loop) demodulator with high linearity; integrated de-emphasis resistor
- Integrated level detector
- Alignment-free FM radio AFC detector with external resonator
- RIF (Radio IF) amplifier for 10.7 MHz
- Stabilizer circuit for ripple rejection and to achieve constant output signals
- ESD (Electrostatic Discharge) protection for all pins.

GENERAL DESCRIPTION

The TDA9809M is an integrated circuit for single standard vision IF signal processing, FM demodulation and FM radio demodulation in multimedia sets.

ORDERING INFORMATION

TYPE NUMBER	PACKAGE		
	NAME	DESCRIPTION	VERSION
TDA9809M	SSOP20	plastic shrink small outline package; 20 leads; body width 5.3 mm	SOT339-1

Single standard multimedia IF-PLL and FM radio demodulator

TDA9809M

QUICK REFERENCE DATA

SYMBOL	PARAMETER	CONDITIONS	MIN.	TYP.	MAX.	UNIT
Supply (pin 19)						
V_P	supply voltage		4.5	5	5.5	V
I_P	supply current	TV mode	76	89	102	mA
		radio mode	29	35	41	mA
		power-down mode	5	8	11	mA
Television mode						
$V_{i(VIF)(rms)}$	minimum vision IF input signal voltage (RMS value)	-1 dB video at output	-	60	100	μ V
$V_{o(video)(p-p)}$	video output signal voltage (peak-to-peak value)		0.97	1.1	1.23	V
B_{-3dB}	-3 dB video bandwidth on pin 13	$C_L < 30$ pF; $R_L > 1.5$ k Ω ; AC load	7	8	-	MHz
$S/N_{W(video)}$	weighted signal-to-noise ratio for video		54	58	-	dB
$\alpha_{IM(0.92/1.1)}$	intermodulation attenuation at 'blue'	$f = 0.92$ or 1.1 MHz	52	58	-	dB
$\alpha_{IM(2.76/3.3)}$	intermodulation attenuation at 'blue'	$f = 2.76$ or 3.3 MHz	52	58	-	dB
$\alpha_{H(sup)}$	suppression of harmonics in video signal		35	40	-	dB
$V_{i(SIF)(rms)}$	minimum sound IF input signal voltage (RMS value)	-3 dB at intercarrier output	-	30	70	μ V
$V_{o(audio)(rms)}$	audio output signal voltage for FM (RMS value)		0.4	0.5	0.6	V
THD_{video}	total harmonic distortion for video		-	0.5	1.0	%
$S/N_{W(audio)}$	weighted signal-to-noise ratio for audio		50	55	-	dB
Radio mode						
$V_{i(RIF)(rms)}$	minimum radio IF input signal voltage (RMS value)	$d_3 < 60$ dB intermodulation; note 1	-	-	20	mV
$V_{i(FM)(rms)}$	minimum FM limiter input signal voltage (RMS value)	$\frac{S+N}{N}$ unweighted = 26 dB	-	100	-	μ V
$\Delta V_{LD}/\log \Delta V_i$	output voltage slope according to FM limiter input voltage		-	50	-	mV/dB μ V
$V_{o(audio)(rms)}$	audio output signal voltage for radio (peak-to-peak value)	22.5 kHz modulation	200	250	300	mV
THD_{audio}	total harmonic distortion for audio	22.5 kHz modulation	-	0.5	1.0	%
$S/N_{W(audio)}$	weighted signal-to-noise ratio for audio	22.5 kHz modulation; 15 kHz bandwidth	59	64	-	dB

Note

- d_3 is the ratio of the intermodulation product at 10.3 MHz to the level of $V_{i(4)(max)(rms)}$.

Single standard multimedia IF-PLL and FM radio demodulator

TDA9809M

BLOCK DIAGRAM

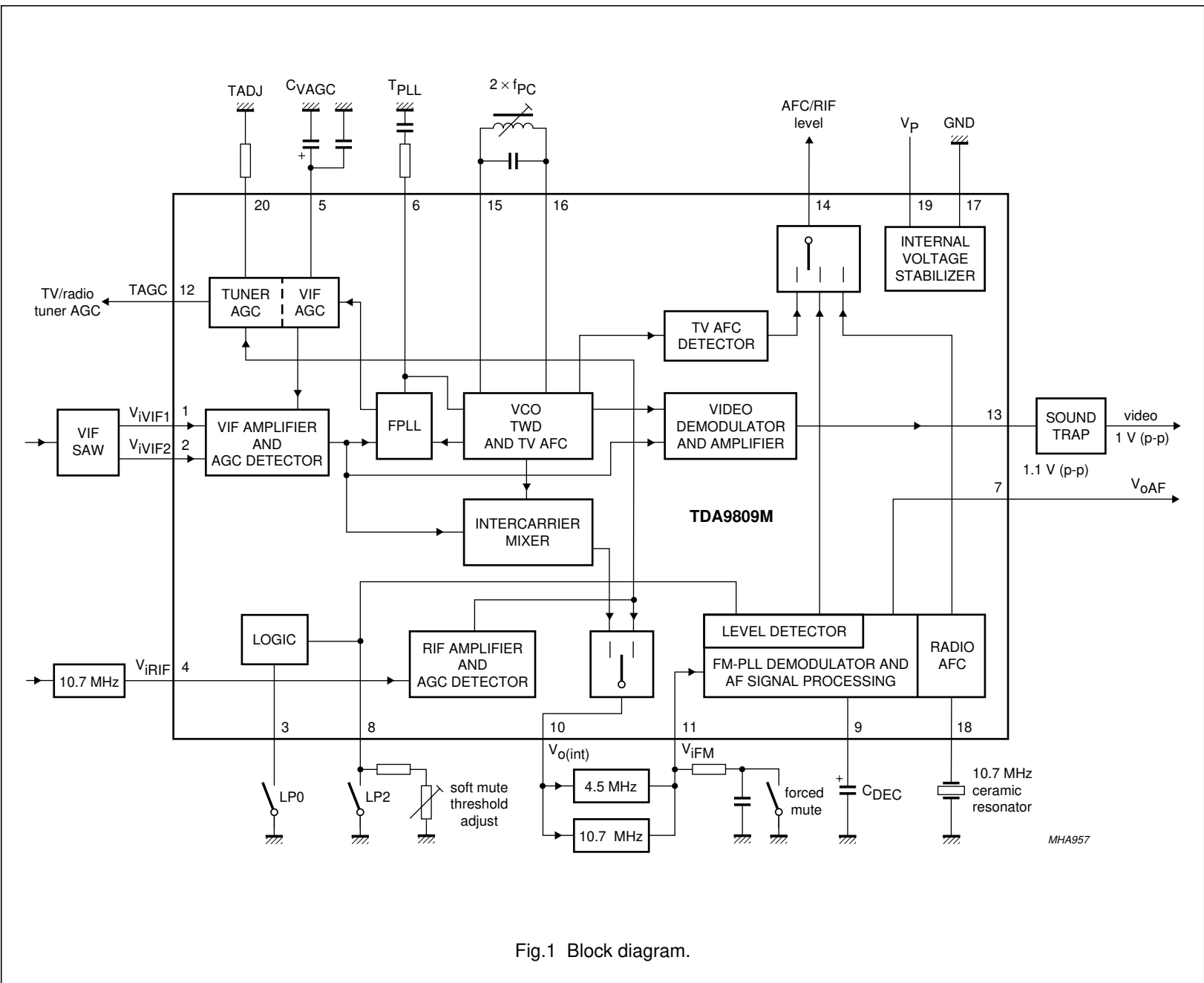

Single standard multimedia IF-PLL and FM radio demodulator

TDA9809M

PINNING

SYMBOL	PIN	DESCRIPTION
V _{iVIF1}	1	VIF differential input signal voltage 1
V _{iVIF2}	2	VIF differential input signal voltage 2
LP0	3	logic port 0
V _{iRIF}	4	RIF input
C _{VAGC}	5	VIF AGC capacitor
T _{PLL}	6	PLL loop filter
V _{oAF}	7	audio output
LP2	8	logic port 2 and soft mute threshold adjustment
C _{DEC}	9	decoupling capacitor
V _{o(int)}	10	intercarrier output voltage
V _{iFM}	11	sound intercarrier input voltage
TAGC	12	TV/radio tuner AGC output
V _{o(vid)}	13	composite video output voltage
AFC	14	AFC/RIF level output
VCO1	15	VCO1 resonance circuit
VCO2	16	VCO2 resonance circuit
GND	17	ground
CERRES	18	ceramic resonator 10.7 MHz
V _P	19	supply voltage
TADJ	20	tuner AGC takeover point adjustment

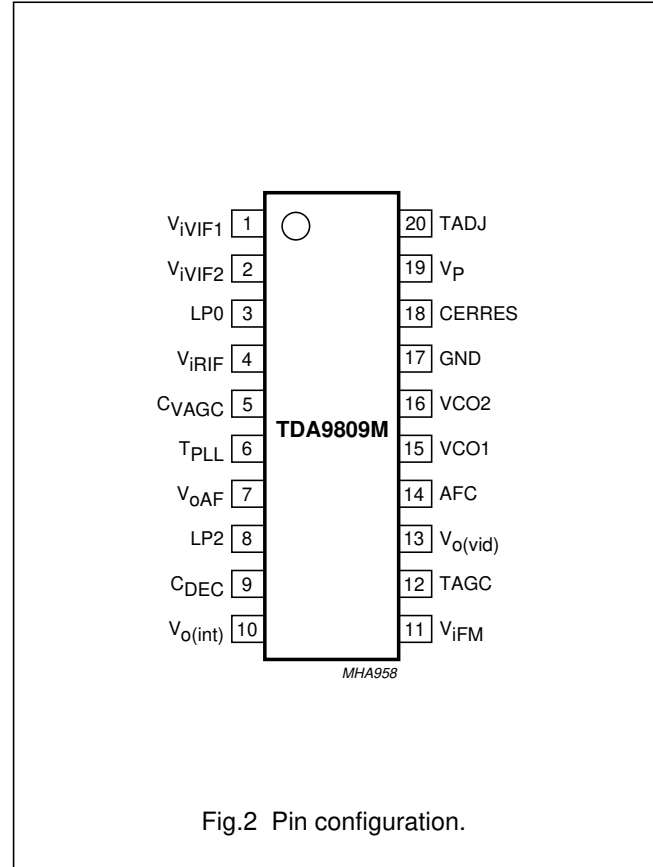

Fig.2 Pin configuration.

FUNCTIONAL DESCRIPTION

The TDA9809M is comprised of the functional blocks shown in Fig.1:

- Vision IF amplifier and AGC detector
- Tuner (TV/radio) and VIF AGC
- Frequency Phase-Locked Loop (FPLL) detector
- VCO, Travelling Wave Divider (TWD) and TV AFC
- Video demodulator and amplifier
- Intercarrier mixer
- RIF amplifier and AGC detector
- FM-PLL demodulator, level detector and radio AFC
- Audio Frequency (AF) signal processing
- Internal voltage stabilizer
- Logic.

Vision IF amplifier and AGC detector

The vision IF amplifier contains three AC-coupled differential amplifier stages. Each differential stage includes a feedback network controlled by emitter degeneration.

The AGC detector generates the required VIF gain control voltage for constant video output by charging/discharging the AGC capacitor. The sync level of the video signal is therefore detected for negative video modulation.

Tuner (TV/radio) and VIF AGC

For TV operation, the AGC capacitor voltage is converted to an internal IF control signal and then fed to the tuner AGC to generate the tuner AGC output current at pin TAGC (open-collector output). The tuner AGC takeover point can be adjusted at pin TADJ. This allows the tuner to be matched to the SAW filter in order to achieve the optimum IF input level.

For FM radio operation, an AGC detector is provided to obtain some adjacent channel protection.

Single standard multimedia IF-PLL and FM radio demodulator

TDA9809M

Frequency Phased-Locked Loop detector (FPLL)

The VIF amplifier output signal is fed, via a limiting amplifier, to a frequency and phase detector. During acquisition, the frequency detector generates a DC current that is proportional to the difference in frequency between the input signal and the VCO signal.

After frequency lock-in, the phase detector generates a DC current proportional to the phase difference between the input signal and the VCO signal. The DC current generated by the frequency or phase detector is converted to a DC voltage via the loop filter, which controls the VCO frequency.

VCO, TWD and TV AFC

The VCO operates with a resonance circuit (with L and C in parallel) at double the Picture Carrier (PC) frequency. The VCO is controlled by two integrated variable capacitors. The control voltage required to tune the VCO from its free-running frequency to double the PC frequency is generated by the FPLL and fed via the loop filter to the first variable capacitor. This control voltage is amplified and converted into a current which represents the AFC output signal. At the centre frequency, the AFC output current is zero.

The TWD divides the oscillator signal by 2 and generates two differential output signals with a 90° phase difference independent of frequency.

Video demodulator and amplifier

Video demodulation is realized by a multiplier designed for low distortion and wide bandwidth. The vision IF input signal and the 'in-phase' signal of the travelling wave divider output are multiplied together.

The demodulated output signal is fed to the video amplifier via an integrated low-pass filter used to attenuate the carrier harmonics. This is an operational amplifier with internal feedback and wide bandwidth. A low-pass filter is integrated to attenuate the carrier harmonics. The video output signal at $V_{o(vid)}$ is 1.1 V (p-p) for nominal vision IF modulation, in order to achieve 1 V (p-p) at the sound trap output.

Intercarrier mixer

The intercarrier mixer is realized by a multiplier.

The sound IF signal passes through the vision IF SAW filter and the composite IF signal is then fed to the intercarrier mixer. Here, the IF signal is multiplied by the 90° TWD output signal to convert the sound IF to the intercarrier frequency. By using this quadrature detection, the low frequency video signals are removed. The mixer output signal is fed, via a high-pass filter used to attenuate the video signal components, at output pin 10.

RIF amplifier and AGC detector

The radio IF amplifier amplifies the 10.7 MHz radio IF signal. This signal is supplied by the tuner and is fed to the RIF input (pin 4) via a matching circuit and a ceramic band-pass filter. This amplifier contains two stages. The first stage, a conventional 0 dB differential amplifier designed for optimal dynamic range, is followed by a switchable differential amplifier stage with a gain of 10 dB. Either the radio IF or the TV IF signal can be selected at the output (pin 10).

The RIF output signal is fed via ceramic band-pass filters to the FM-PLL demodulator and the radio IF AGC detector. The AGC threshold is very high and is designed to obtain some adjacent channel protection. The AGC detector output is fed to the tuner AGC output stage (pin 12) to control the tuner.

FM-PLL demodulator, level detector and radio AFC

The FM-PLL demodulator consists of a limiter and an FM phase-locked loop. The 8-stage internally AC-coupled limiter amplifies and limits the TV FM sound intercarrier or the radio FM intermediate frequency signal prior to demodulation. The limiter is designed for high sensitivity and AM suppression with low DC offset and needs no external pins for DC coupling.

Furthermore, the AF output signal can be force muted by connecting a resistor between pin 11 and ground. The soft mute function can be disabled by connecting a resistor between pin 11 and the power supply. See the application circuit in Fig.16.

Single standard multimedia IF-PLL and FM radio demodulator

TDA9809M

The FM-PLL consists of an integrated relaxation oscillator, an integrated loop filter and a phase detector.

The oscillator is locked to the FM intercarrier signal output from the limiter. As a result of locking, the oscillator frequency tracks with the modulation of the input signal and the oscillator control voltage is superimposed on the AF voltage. The FM-PLL operates as an FM demodulator.

The level detector detects, rectifies and amplifies the output signals from the first 5 limiter stages. These signals are then summed and the composite signal passed through a low-pass filter, followed by a 6 dB output amplifier. A DC voltage dependent on the limiter input level is generated for controlling the behaviour of the AF soft mute. The 6 dB output amplifier can be switched off via the control logic and the level detector output signal fed to pin 14. Furthermore, the steepness of the level detector output signal tracks that of the power supply voltage.

The radio Automatic Frequency Control (AFC) stage is comprised of a 10.7 MHz phase shifting network, a phase detector (quadrature demodulator), a differential amplifier input stage (which receives the limiting amplifier output signal) and a current mode output stage.

A ceramic resonator is used for phase shifting. This permits alignment-free operation.

AF signal processing

The AF signal processing stage consists of a pre-amplifier for the FM-PLL demodulator output signal, an AF source selector, a soft and forced mute stage with an integrated time constant and an AF post-amplifier.

The FM demodulator output signal is pre-amplified by an operational amplifier (30 dB gain) with internal feedback, high gain and high common mode rejection. The feedback circuit, together with external capacitor C_{DEC} connected to pin 9, keeps the DC level at the pre-amplifier output constant (2.3 V). An external resistor connected in series with C_{DEC} provides a gain reduction capability.

The low-pass filter characteristic (130 kHz bandwidth) of the amplifier reduces the harmonics of the IF signal at the sound signal output.

Soft mute occurs when the internal level detector output voltage is lower than the mute threshold voltage at pin 8 (provided an external resistor is not connected between the limiter input, pin 11, and the supply voltage). The mute stage reduces the AF signal by 25 dB, with an internal time constant of approximately 7 ms.

If a resistor is connected between pin 11 and ground (forced mute), the mute stage will reduce the AF signal by more than 70 dB with the same time constant.

Otherwise, the AF signal will not be reduced.

The AF post-amplifier, which was designed to include a rail-to-rail output stage, provides the required AF output level at pin 7.

Internal voltage stabilizer

The bandgap circuit generates a voltage of approximately 1.25 V internally, independent of supply voltage and temperature. A voltage regulator circuit connected to this voltage generates a constant 3.6 V which is used as an internal reference voltage.

Logic

The logic circuit detects the logic levels and threshold voltages at ports LP0 and LP2 and controls the internal functions as described in Table 2.

Single standard multimedia IF-PLL and FM radio demodulator

TDA9809M

LIMITING VALUES

In accordance with the Absolute Maximum Rating System (IEC 134).

SYMBOL	PARAMETER	CONDITIONS	MIN.	MAX.	UNIT
V_P	supply voltage (pin 19)	maximum chip temperature of 130 °C; note 1	–	5.5	V
V_n	input voltage at pins 1 to 9, 11, 12, 14 and 17 to 20		0	V_P	V
t_{sc}	short-circuit time		–	10	s
V_{TAGC}	tuner AGC output voltage		0	13.2	V
T_{stg}	storage temperature		–25	+150	°C
T_{amb}	ambient operating temperature		–20	+70	°C
V_{es}	electrostatic handling	note 2	–300	+300	V

Notes

- $I_P = 102$ mA; $T_{amb} = 70$ °C; $R_{th(j-a)} = 120$ K/W.
- Machine model class B ($L = 2.5$ μ H).

THERMAL CHARACTERISTICS

SYMBOL	PARAMETER	CONDITIONS	VALUE	UNIT
$R_{th(j-a)}$	thermal resistance from junction to ambient	in free air	120	K/W

CHARACTERISTICS

$V_P = 5$ V; $T_{amb} = 25$ °C; see Table 1 for input frequencies; input level $V_{i(VIF)(rms)} = 10$ mV (sync-level for B/G); $V_{i(FM)(rms)} = 10$ mV; IF input from 50 Ω via broadband transformer 1 : 1; video modulation DSB; residual carrier B/G: 10%; video signal in accordance with "CCIR, line 17" or "NTC-7 Composite"; test circuit in Fig.15 used for measurements; unless otherwise specified.

SYMBOL	PARAMETER	CONDITIONS	MIN.	TYP.	MAX.	UNIT
Supply (pin 19)						
V_P	supply voltage	note 1	4.5	5	5.5	V
I_P	supply current	TV mode	76	89	102	mA
		radio mode	29	35	41	mA
		power-down mode	5	8	11	mA
Television mode						
VISION IF AMPLIFIER (PINS 1 AND 2)						
$V_{i(VIF)(rms)}$	minimum vision IF input signal voltage (RMS value)	$f_{PC} = 38.9$ or 45.75 MHz; –1 dB video at output	–	60	100	μ V
	maximum vision IF input signal voltage (RMS value)	$f_{PC} = 38.9$ or 45.75 MHz; +1 dB video at output	120	200	–	mV

Single standard multimedia IF-PLL and FM radio demodulator

TDA9809M

SYMBOL	PARAMETER	CONDITIONS	MIN.	TYP.	MAX.	UNIT
$\Delta V_{o(int)}$	internal IF amplitude difference between picture and sound carrier	within AGC range; $\Delta f = 4.5$ MHz	–	0.7	1	dB
$G_{VIF(CR)}$	VIF gain control range	see Fig.3	65	70	–	dB
$B_{VIF(-3dB)}$	–3 dB VIF bandwidth	lower limit	–	15	25	MHz
		upper limit	70	100	–	MHz
$R_{i(dif)}$	differential input resistance	note 2	1.7	2.2	2.7	k Ω
$C_{i(dif)}$	differential input capacitance	note 2	1.2	1.7	2.5	pF
V_I	DC input voltage	note 2	–	3.4	–	V
TRUE SYNCHRONOUS VIDEO DEMODULATOR; note 3						
$f_{VCO(max)}$	maximum oscillator frequency for carrier regeneration	$f = 2f_{PC}$	125	130	–	MHz
$\Delta f_{osc}/\Delta T$	oscillator drift as a function of temperature	oscillator is free-running; $I_{AFC} = 0$; note 4	–	–	$\pm 20 \times 10^{-6}$	K $^{-1}$
$V_{VCO(rms)}$	oscillator voltage swing at pins 15 and 16 (RMS value)	$f_{PC} = 38.9$ MHz	50	80	110	mV
		$f_{PC} = 45.75$ MHz	40	65	90	mV
$f_{cr(PC)}$	picture carrier capture range		± 1.4	± 1.8	–	MHz
t_{acq}	acquisition time	Black Level (BL) = 70 kHz note 5	–	–	30	ms
$V_{i(VIF)(rms)}$	minimum vision IF input signal voltage for PLL to be locked (RMS value)	maximum IF gain; note 6	–	30	70	μ V
COMPOSITE VIDEO AMPLIFIER (PIN 13; SOUND CARRIER OFF)						
$V_{o(video)(p-p)}$	output signal voltage (peak-to-peak value)	see Fig.7	0.97	1.1	1.23	V
V/S	ratio of video (black-to-white) to sync level		1.9	2.33	3.0	–
V_{sync}	sync voltage level		1.4	1.5	1.6	V
V_{clu}	upper video clipping voltage level		$V_P - 1.1$	$V_P - 1$	–	V
V_{cll}	lower video clipping voltage level		–	0.7	0.9	V
R_o	output resistance	note 2	–	–	10	Ω

Single standard multimedia IF-PLL and FM radio demodulator

TDA9809M

SYMBOL	PARAMETER	CONDITIONS	MIN.	TYP.	MAX.	UNIT
$I_{bias(int)}$	internal DC bias current for emitter-follower		2.2	3.0	–	mA
$I_{o(sink)(max)}$	maximum AC and DC output sink current		1.6	–	–	mA
$I_{o(source)(max)}$	maximum AC and DC output source current		2.9	–	–	mA
$\Delta V_{o(CVBS)}$	deviation of CVBS output signal voltage	50 dB gain control	–	–	0.5	dB
		30 dB gain control	–	–	0.1	dB
$\Delta V_{o(bl)(BG)}$	black level tilt in B/G standard	gain variation; note 7	–	–	1	%
G_{dif}	differential gain	“CCIR, line 330” or “NTC-7 Composite”	–	2	5	%
ϕ_{dif}	differential phase	“CCIR, line 330” or “NTC-7 Composite”	–	2	4	deg
$B_{V(-1dB)}$	–1 dB video bandwidth	$C_L < 50 \text{ pF}$; $R_L > 1 \text{ k}\Omega$; AC load	5	6	–	MHz
$B_{V(-3dB)}$	–3 dB video bandwidth	$C_L < 50 \text{ pF}$; $R_L > 1 \text{ k}\Omega$; AC load	7	8	–	MHz
S/N_W	weighted signal-to-noise ratio	see Fig.4 and note 8	54	58	–	dB
S/N	unweighted signal-to-noise ratio	see Fig.4 and note 8	47	51	–	dB
$\alpha_{IM(0.92/1.1)}$	intermodulation attenuation at ‘blue’	$f_{IM} = 0.92 \text{ or } 1.1 \text{ MHz}$; see Fig.5 and note 9	52	58	–	dB
	intermodulation attenuation at ‘yellow’	$f_{IM} = 0.92 \text{ or } 1.1 \text{ MHz}$; see Fig.5 and note 9	54	60	–	dB
$\alpha_{IM(2.76/3.3)}$	intermodulation attenuation at ‘blue’	$f_{IM} = 2.76 \text{ or } 3.3 \text{ MHz}$; see Fig.5 and note 9	52	58	–	dB
	intermodulation attenuation at ‘yellow’	$f_{IM} = 2.76 \text{ or } 3.3 \text{ MHz}$; see Fig.5 and note 9	54	60	–	dB
$\alpha_{r(vc)(rms)}$	residual vision carrier (RMS value)	fundamental wave and harmonics	–	2	5	mV
$\alpha_{H(sup)}$	harmonics suppression in video signal	note 10a	35	40	–	dB
$\alpha_{H(spur)}$	spurious element suppression	note 10b	40	–	–	dB
PSRR	power supply ripple rejection at pin 13	video signal; grey level; see Fig.9	30	35	–	dB

Single standard multimedia IF-PLL and FM radio demodulator

TDA9809M

SYMBOL	PARAMETER	CONDITIONS	MIN.	TYP.	MAX.	UNIT
VIF-AGC DETECTOR (PIN 5)						
I_{ch}	charge current	note 7	0.75	1	1.25	mA
I_{dch}	discharge current		15	20	25	μ A
$t_{res(AGC)(r)}$	AGC response time to a rising VIF step	note 11	–	0.05	0.1	ms/dB
$t_{res(AGC)(f)}$	AGC response time to a falling VIF step		–	2.2	3.5	ms/dB
TV TUNER AGC (PIN 12)						
$V_{i(rms)}$	IF input signal voltage for minimum onset of tuner takeover (RMS value)	input at pins 1 and 2; $R_{TOP} = 22 \text{ k}\Omega$; $I_{12} = 0.4 \text{ mA}$	–	2	5	mV
	IF input signal voltage for maximum onset of tuner takeover (RMS value)	input at pins 1 and 2; $R_{TOP} = 0 \text{ }\Omega$; $I_{12} = 0.4 \text{ mA}$	50	100	–	mV
	tuner takeover point accuracy (RMS value)	$R_{TOP} = 13 \text{ k}\Omega$; $I_{12} = 0.4 \text{ mA}$	5	–	20	mV
$V_{o(max)}$	maximum output voltage	from external source; note 2	–	–	13.2	V
V_{sat}	saturation voltage	$I_{12} = 1.5 \text{ mA}$	–	–	0.2	V
$\Delta V_{TOP}/\Delta T$	variation of takeover point with temperature	$I_{12} = 0.4 \text{ mA}$	–	0.03	0.07	dB/K
I_{sink}	sink current	see Fig.3 no tuner gain reduction; $V_{12} = 13.2 \text{ V}$	–	–	1	μ A
		maximum tuner gain reduction	1.5	2	2.6	mA
ΔG_{IF}	IF slip by automatic gain control	tuner gain current from 20 to 80%	–	6	8	dB
TV AFC DETECTOR (PIN 14); see Fig.6 and note 12						
CR_{stps}	control steepness $\Delta I_{14}/\Delta f$	$f_{PC} = 38.9 \text{ MHz}$; note 13	0.5	0.75	1.0	μ A/kHz
		$f_{PC} = 45.75 \text{ MHz}$; note 13	0.4	0.65	0.9	μ A/kHz
$\Delta f_{IF}/\Delta T$	frequency variation with temperature	$I_{AFC} = 0$; note 4	–	–	$\pm 20 \times 10^{-6}$	K^{-1}
$V_{o(max)}$	output voltage upper limit	see Fig.6 without external components	$V_P - 0.6$	$V_P - 0.3$	–	V
$V_{o(min)}$	output voltage lower limit		–	0.3	0.6	V
$I_{o(source)}$	output source current		150	200	250	μ A
$I_{o(sink)}$	output sink current		150	200	250	μ A
$\Delta I_{r(mod)(p-p)}$	residual video modulation current (peak-to-peak value)		–	20	30	μ A

Single standard multimedia IF-PLL and FM radio demodulator

TDA9809M

SYMBOL	PARAMETER	CONDITIONS	MIN.	TYP.	MAX.	UNIT
INTERCARRIER MIXER (PIN 10)						
$V_{o(\text{intercarrier})}(\text{rms})$	IF intercarrier level (RMS value)	sound carrier 1 (SC ₁); SC ₂ off; note 14	–	32	–	mV
$B_{-3\text{dB}}$	–3 dB intercarrier bandwidth	upper limit	7.5	9	–	MHz
$\alpha_{r(\text{SC})}(\text{rms})$	residual sound carrier (RMS value)	fundamental wave and harmonics	–	2	5	mV
$\alpha_{r(\text{VC})}(\text{rms})$	residual vision carrier (RMS value)	fundamental wave and harmonics	–	2	5	mV
$\alpha_{H(\text{sup})}$	suppression of video signal harmonics	intercarrier mode; $f_{\text{video}} \leq 5$ MHz	39	–	–	dB
R_o	output resistance	note 2	–	25	–	Ω
V_o	DC output voltage		–	2.0	–	V
$I_{\text{bias}(\text{int})}$	DC internal bias current for emitter-follower		2.7	3.4	–	mA
$I_{o(\text{sink})}(\text{max})$	maximum AC and DC output sink current		1.5	2.0	–	mA
$I_{o(\text{source})}(\text{max})$	maximum AC and DC output source current		2.5	–	–	mA
LIMITER AMPLIFIER (PIN 11); note 15						
$V_{i(\text{FM})}(\text{rms})$	input signal voltage for lock-in (RMS value)		–	–	100	μV
	input signal voltage (RMS value)	$\frac{S+N}{N}$ weighted = 40 dB	–	250	500	μV
	allowed input signal voltage (RMS value)		200	–	–	mV
α_{AM}	AM suppression	50 μs de-emphasis; AM: $f_{\text{mod}} = 1$ kHz; $m = 0.3$ referenced to 27 kHz (54% FM deviation)	46	50	–	dB
R_i	input resistance	note 2	480	600	720	Ω
V_i	DC input voltage		–	2.65	–	V
FM-PLL DEMODULATOR						
$f_{\text{cr}(\text{PLL})}$	catching range of PLL	upper limit	7.0	–	–	MHz
		lower limit	–	–	4.0	MHz
$f_{\text{hr}(\text{PLL})}$	holding range of PLL	upper limit	9.0	–	–	MHz
		lower limit	–	–	3.5	MHz
t_{acq}	acquisition time		–	–	4	μs

Single standard multimedia IF-PLL and FM radio demodulator

TDA9809M

SYMBOL	PARAMETER	CONDITIONS	MIN.	TYP.	MAX.	UNIT
FM OPERATION (PIN 7); notes 15 and 15a						
$V_{o(AF)(rms)}$	AF output signal voltage (RMS value)	$R_x = 0 \Omega$; see Fig.15 and note 16 27 kHz (54% FM deviation)	400	500	600	mV
		25 kHz (50% FM deviation)	360	460	560	mV
$V_{o(AF)(cl)(rms)}$	AF output clipping signal voltage level (RMS value)	THD < 1.5%	1.0	–	1.2	V
Δf_{AF}	frequency deviation	THD < 1.5%; note 16	–	–	± 53	kHz
$\Delta V_o/\Delta T$	temperature drift of AF output signal voltage		–	3×10^{-3}	7×10^{-3}	dB/K
V_9	DC voltage at decoupling capacitor	voltage dependent on VCO frequency; note 17	1.2	–	3.0	V
R_o	output resistance	note 2	–	–	150	Ω
V_o	DC output voltage		–	2.3	–	V
$I_{o(sink)(max)}$	maximum AC and DC output sink current		–	–	0.5	mA
$I_{o(source)(max)}$	maximum AC and DC output source current		–	–	0.5	mA
$B_{aud(-3dB)}$	–3 dB audio frequency bandwidth		100	125	–	kHz
THD	total harmonic distortion	27 kHz (54% FM deviation)	–	0.5	1.0	%
S/N _w	weighted signal-to-noise ratio	FM-PLL only; with 50 μ s de-emphasis; 27 kHz (54% FM deviation); "CCIR 468-4"; see Fig.8	50	55	–	dB
$\alpha_{r(SC)(rms)}$	residual sound carrier (RMS value)	fundamental wave and harmonics	–	–	75	mV
$\alpha_{mute(AF)}$	mute attenuation of AF signal		70	75	–	dB
ΔV_7	DC jump voltage of AF output terminal for switching AF output to mute state and vice versa	FM-PLL in lock mode	–	± 50	± 150	mV
PSRR	power supply ripple rejection at pin 7	$R_x = 0 \Omega$; $f_{mod} = 70$ Hz; see Figs 9 and 15	20	26	–	dB

Single standard multimedia IF-PLL and FM radio demodulator

TDA9809M

SYMBOL	PARAMETER	CONDITIONS	MIN.	TYP.	MAX.	UNIT
INTERCARRIER AF PERFORMANCE FOR FM OPERATION; notes 18, 19 and 20; see Table 1						
$S/N_{W(SC1)}$	weighted signal-to-noise ratio for SC_1	PC/ SC_1 ratio at pins 1 and 2; 27 kHz (54% FM deviation); "CCIR 468-4"; 50 μ s (75 μ s at M standard)	27	–	–	dB
		black picture	41	47	–	dB
		white picture	41	47	–	dB
		6 kHz sine wave (black-to-white modulation)	35	40	–	dB
		sound carrier subharmonics; $f_{mod} = 2.75 \text{ MHz} \pm 3 \text{ kHz}$	30	35	–	dB
Radio mode						
RIF AMPLIFIER (PINS 4 AND 10)						
$V_{i(4)(max)(rms)}$	maximum input signal voltage (RMS value)	$d_3 < 60 \text{ dB}$ intermodulation; notes 21 and 22	10	20	–	mV
$V_{o(10)(cl)(rms)}$	RF amplifier output clipping signal voltage level (RMS value)	–1 dB gain compression point; note 21	400	–	900	mV
G_{RIF}	RIF gain		10	13	16	dB
$B_{RIF(-3dB)}$	–3 dB RIF bandwidth	lower limit	–	100	–	kHz
		upper limit	–	25	–	MHz
$R_{i(SE)}$	single-ended input resistance	note 2	240	330	420	Ω
$C_{i(SE)}$	single-ended input capacitance	note 2	1.5	2	2.5	pF
R_o	output resistance	note 2	–	25	–	Ω
$V_{I(4)}$	DC input voltage	note 2	–	2.7	–	V
RADIO TUNER AGC (PIN 12)						
I_{sink}	sink current	maximum tuner gain reduction	1.5	2	2.6	mA
$V_{o(max)}$	maximum output voltage	from external source; note 2	–	–	13.2	V
$V_{o(10)(rms)}$	AGC onset (RMS value)	RIF amplifier output; $I_{12} = 0.4 \text{ mA}$	–	180	–	mV

Single standard multimedia IF-PLL and FM radio demodulator

TDA9809M

SYMBOL	PARAMETER	CONDITIONS	MIN.	TYP.	MAX.	UNIT
RADIO AFC DETECTOR (PIN 14); see Fig.11 and note 12a						
CR_{stps}	control steepness $\Delta I_{14}/\Delta f$	note 23	0.59	0.9	1.22	$\mu\text{A}/\text{kHz}$
Δf_{IF}	frequency variation by input level	note 2	–	–	50×10^{-6}	$(\text{dB}\mu\text{V})^{-1}$
$V_{O(max)}$	output voltage upper limit	see Fig.11 without external components	$V_P - 0.6$	$V_P - 0.3$	–	V
$V_{O(min)}$	output voltage lower limit		–	0.3	0.6	V
$I_{O(source)}$	output source current		150	200	250	μA
$I_{O(sink)}$	output sink current		150	200	250	μA
LIMITER AMPLIFIER (PIN 11); note 15						
$V_{i(FM)(rms)}$	input signal voltage (RMS value)	–3 dB AF signal at pin 7	–	50	–	μV
		$\Delta f = 22.5 \text{ kHz};$ $\frac{S+N}{N}$ unweighted = 26 dB	–	100	–	μV
	allowed input signal voltage (RMS value)		200	–	–	mV
α_{AM}	AM suppression	50 μs de-emphasis; AM: $f_{mod} = 1 \text{ kHz}; m = 0.3$ referenced to 22.5 kHz	40	45	–	dB
R_i	input resistance	note 2	240	330	420	Ω
V_I	DC input voltage		–	2.65	–	V
LEVEL DETECTOR (PIN 14); note 12						
$\Delta V_{LD}/\log \Delta V_i$	output voltage slope according to FM limiter input voltage		–	50	–	$\text{mV}/\text{dB}\mu\text{V}$
$V_{O(LD)(min)}$	minimum DC output voltage	$V_{i(11)} = 56 \mu\text{V}$ (35 $\text{dB}\mu\text{V}$)	0	–	1.0	V
$V_{O(LD)}$	DC output voltage	$V_{i(11)} = 32 \text{ mV}$ (90 $\text{dB}\mu\text{V}$)	–	3.00	–	V
$V_{O(LD)(max)}$	maximum DC output voltage		–	–	$V_P - 1.0$	V
$\Delta V_O/\Delta V_P$	output voltage variation with V_P		0.5	0.7	0.9	V/V
$\Delta V_O/\Delta T$	output voltage variation with temperature		–	–	$\pm 100 \times 10^{-6}$	V/K
FM-PLL DEMODULATORS						
$f_{cr(PLL)}$	catching range of PLL	upper limit	11.5	–	–	MHz
		lower limit	–	–	9.0	MHz
$f_{hr(PLL)}$	holding range of PLL	upper limit	13.0	–	–	MHz
		lower limit	–	–	8.0	MHz
t_{acq}	acquisition time		–	–	4	μs

Single standard multimedia IF-PLL and FM radio demodulator

TDA9809M

SYMBOL	PARAMETER	CONDITIONS	MIN.	TYP.	MAX.	UNIT
FM OPERATION (PIN 7); notes 15 and 15a						
$V_{O(AF)(rms)}$	AF output signal voltage (RMS value)	22.5 kHz; $R_x = 0 \Omega$; see Fig.15 and note 16	200	250	300	mV
$V_{O(AF)(cl)(rms)}$	AF output clipping signal voltage level (RMS value)	THD < 1.5%	1.0	–	1.2	V
Δf_{AF}	frequency deviation	THD < 1.5%; note 16	–	–	± 75	kHz
$\Delta V_O/\Delta T$	temperature drift of AF output signal voltage		–	3×10^{-3}	7×10^{-3}	dB/K
V_9	DC voltage at decoupling capacitor	voltage dependent on VCO frequency; note 17	1.2	–	3.0	V
R_O	output resistance	note 2	–	–	150	Ω
V_O	DC output voltage		–	2.3	–	V
$I_{O(sink)(max)}$	maximum AC and DC output sink current		–	–	0.5	mA
$I_{O(source)(max)}$	maximum AC and DC output source current		–	–	0.5	mA
$B_{AF(-3dB)}$	–3 dB AF bandwidth	22.5 kHz	100	125	–	kHz
THD	total harmonic distortion	22.5 kHz	–	0.5	1.0	%
S/N	unweighted signal-to-noise ratio	FM-PLL only; with 50 μ s de-emphasis; 22.5 kHz; 15 kHz bandwidth	59	64	–	dB
ΔV_7	DC jump voltage of AF output terminal for switching AF output to mute state and vice versa	FM-PLL in lock mode	–	± 50	± 150	mV
PSRR	power supply ripple rejection at pin 7	$R_x = 0 \Omega$; $f_{mod} = 70$ Hz; see Figs 9 and 15	20	26	–	dB
MUTE BEHAVIOUR; note 15						
α_{mute}	forced mute attenuation	pin 11 at V_P	70	75	–	dB
	soft mute attenuation	RIF level dependent; see Fig.12	20	25	30	dB
$I_{11(forced)}$	forced mute switching current	$\alpha_7 > 70$ dB	–	350	–	μ A
$I_{11(soft)(dis)}$	current for disabling soft mute	$\alpha_7 > 0$ dB	–	–350	–	μ A
$V_{th(8)}$	soft mute threshold adjustment voltage	$V_{i(11)} = 56 \mu$ V	0.8	1.0	1.2	V
		$V_{i(11)} = 560 \mu$ V	1.2	1.4	1.6	V
t_{mute}	time constant	mute on or off	3	–	7	ms

Single standard multimedia IF-PLL and FM radio demodulator

TDA9809M

SYMBOL	PARAMETER	CONDITIONS	MIN.	TYP.	MAX.	UNIT
Switching levels for logic port 0; see also Table 2						
V _{logic}	DC potential for logic 1 or pin not connected		2.8	–	V _P	V
	DC potential for logic 0		0	–	0.8	V
I _{IL}	LOW-level input current	V _{3,8} = 0 V	50	70	90	μA
Switching levels for logic port 2; see also Table 2 and Fig.12						
V _{logic}	DC potential for logic 1 or pin not connected		0.8	–	V _P	V
	DC potential for logic 0		0	–	0.8	V
I _{IL}	LOW-level input current	V ₁₁ = 0 V	110	150	190	μA

Notes

- Video and sound parameters are degraded at $V_P \leq 4.5$ V.
- This parameter is not tested during production and is provided as application information for use in designing the television receiver.
- Loop bandwidth $BL = 70$ kHz (natural frequency $f_n = 12$ kHz; damping factor $d \approx 3$; calculated for peak level). Resonance circuit of VCO: $Q_0 > 50$; $C_{VCO} = 8.2$ pF \pm 0.25 pF; $C_{int} \approx 8.5$ pF (loop voltage ≈ 2.7 V).
- Temperature coefficient of external LC circuit is equal to zero.
- $V_{i(VIF)(rms)} = 10$ mV; $\Delta f = 1$ MHz (VCO frequency offset related to picture carrier frequency); white picture video modulation.
- $V_{i(VIF)}$ signal for nominal video signal.
- The leakage current of the AGC capacitor should not exceed 1 μA to avoid larger tilt.
- S/N is the ratio of black-to-white amplitude to the black level noise voltage (RMS value, pin 13). B = 5 MHz weighted in accordance with "CCIR 567".
- The intermodulation figures are defined:

$$\alpha_{IM(0.92/1.1)} = 20 \log \left(\frac{V_0 \text{ at } 3.58 \text{ (4.4) MHz}}{V_0 \text{ at } 0.92 \text{ (1.1) MHz}} \right) + 3.6 \text{ dB}; \alpha_{IM(0.92/1.1)} \text{ value at } 0.92 \text{ or } 1.1 \text{ MHz referenced to black/white signal;}$$

$$\alpha_{IM(2.76/3.3)} = 20 \log \left(\frac{V_0 \text{ at } 3.58 \text{ (4.4) MHz}}{V_0 \text{ at } 2.76 \text{ (3.3) MHz}} \right); \alpha_{IM(2.76/3.3)} \text{ value at } 2.76 \text{ or } 3.3 \text{ MHz referenced to colour carrier.}$$
- Measurements taken with SAW filter G1962 (sound shelf: 20 dB); loop bandwidth = 70 kHz.
 - Modulation VSB; sound carrier **off**; $f_{video} > 0.5$ MHz.
 - Sound carrier **on**; SIF SAW filter K9453; $f_{video} = 10$ kHz to 10 MHz.
- Response speed valid for a VIF input level range of 200 μV up to 70 mV.
- A current source output is provided to match the AFC output signal to different tuning systems. The test circuit is given in Fig.6 for TV mode and in Fig.11 for radio mode. The AFC steepness can be changed by the resistors at pin 14.
 - A voltage output is provided to match the AFC output signal to different tuning systems. The DC load current should not exceed 180 μA.
- Depending on the ratio $\Delta C/C_0$ of the LC resonant circuit of the VCO ($Q_0 > 50$; see note 3; $C_0 = C_{int} + C_{ext}$).

Single standard multimedia IF-PLL and FM radio demodulator

TDA9809M

14. The intercarrier output signal at pin 10 can be calculated with the following formula using the video output signal at pin 13 ($V_{o(\text{video})(p-p)} = 1.1 \text{ V}$ typical) as a reference:

$$V_{o(\text{rms})} = 1.1 \text{ V (p-p)} \times \frac{1}{2\sqrt{2}} \times 10^{\frac{\frac{V_{i(\text{SC})}(\text{dB}) + 6 \text{ dB} \pm 3 \text{ dB}}{V_{i(\text{PC})}}}{20}}$$

with $\frac{1}{2\sqrt{2}}$ = correction term for RMS value,

$\frac{V_{i(\text{SC})}}{V_{i(\text{PC})}}(\text{dB})$ = sound-to-picture carrier ratio at VIF input (pins 1 and 2) in dB,

6 dB = correction term of internal circuitry and $\pm 3 \text{ dB}$ = tolerance of video output and intercarrier output amplitude $V_{o(\text{rms})}$.

Example: SAW filter G1962 (sound shelf: 20 dB) $\Rightarrow \frac{V_{i(\text{SC})}}{V_{i(\text{PC})}} = -27 \text{ dB} \Rightarrow V_{o(\text{rms})} = 32 \text{ mV (typ.)}$.

15. Input level for second IF from an external generator with 50Ω source impedance. AC-coupled with 10 nF capacitor, $f_{\text{mod}} = 1 \text{ kHz}$, 27 kHz (54% FM deviation) of audio reference. A VIF/SIF input signal is not permitted. Pin 5 has to be connected to the positive supply voltage for minimum IF gain. S/N and THD measurements are taken at $50 \mu\text{s}$ (75 μs at M standard) de-emphasis (modulator pre-emphasis has to be activated). The FM demodulator steepness $\Delta V_{o(\text{AF})}/\Delta f_{\text{AF}}$ is positive.
- a) Second IF input level 10 mV (RMS).
16. Measured with an FM deviation of 27 kHz, the typical AF output signal is 500 mV (RMS) ($R_x = 0 \Omega$). By using $R_x = 680 \Omega$ the AF output signal is attenuated by 6 dB (250 mV RMS). For handling a frequency deviation of more than 53 kHz the AF output signal has to be reduced by using R_x in order to avoid clipping (THD < 1.5%). For an FM deviation up to 100 kHz an attenuation of 6 dB is recommended with $R_x = 680 \Omega$.
17. The leakage current of the decoupling capacitor (2.2 μF) should not exceed 1 μA .
18. For all S/N measurements, the vision IF modulator used must meet the following specifications:
- a) Incidental phase modulation for black-to-white jump less than 0.5 degrees.
- b) QSS AF performance, measured with the television-demodulator AMF2 (audio output, weighted S/N ratio) better than 60 dB (deviation $\pm 27 \text{ kHz}$) for 6 kHz sine wave black-to-white video modulation.
- c) Picture-to-sound carrier ratio; $\text{PC}/\text{SC}_1 = 13 \text{ dB}$; (transmitter).
19. The PC/SC_1 ratio at pins 1 and 2 is calculated as the addition of TV transmitter PC/SC_1 ratio and SAW filter PC/SC_1 ratio. This PC/SC_1 ratio is necessary to achieve the $\text{S}/\text{N}_{\text{W}}$ values as noted. A different PC/SC_1 ratio will change these values.
20. Measurements taken with SAW filter G1962 (sound shelf: 20 dB) for vision and sound IF.
21. The RIF amplifier output (pin 10) must be connected to a multistandard application ceramic filter for 5.5, 6.0 and 10.7 MHz. This total load constitutes an impedance of 250Ω .
22. d_3 tested using two signals with frequencies of $f_1 = 10.5 \text{ MHz}$ and $f_2 = 10.7 \text{ MHz}$, and with a level of $V_{i(4)(\text{max})(\text{rms})}$ for each signal. d_3 is the ratio of the intermodulation product at 10.3 MHz to the output level of $V_{i(4)(\text{max})(\text{rms})}$.
23. The control steepness of the radio AFC detector is dependent on the characteristic of the ceramic resonator, pin 18. The figure given here will be obtained when applying a typical resonator of the type CDA 10.7 MC1-A (Murata). The spread of the control steepness depends on the spread of the ceramic resonator characteristic (see Fig.11).

Single standard multimedia IF-PLL and FM radio demodulator

TDA9809M

Table 1 Input frequencies and carrier ratios

DESCRIPTION	SYMBOL	B/G STANDARD	M/N STANDARD	FM RADIO	UNIT
Picture/IF carrier	f_{PC} or f_{IF}	38.9	45.75	10.7	MHz
Sound carrier	f_{SC1}	33.4	41.25	–	MHz
	f_{SC2}	33.158	–	–	MHz
Picture-to-sound carrier	PC/SC ₁	13	7	–	dB
	PC/SC ₂	20	–	–	dB

Table 2 Switch logic

FUNCTION			LP2	LP0	REMARKS
Power-down			0	0	
TV mode		negative modulation	0	1	
Radio mode	AFC	soft mute active	1	0	RIF level dependent (25 dB)
	RIF level		1	1	

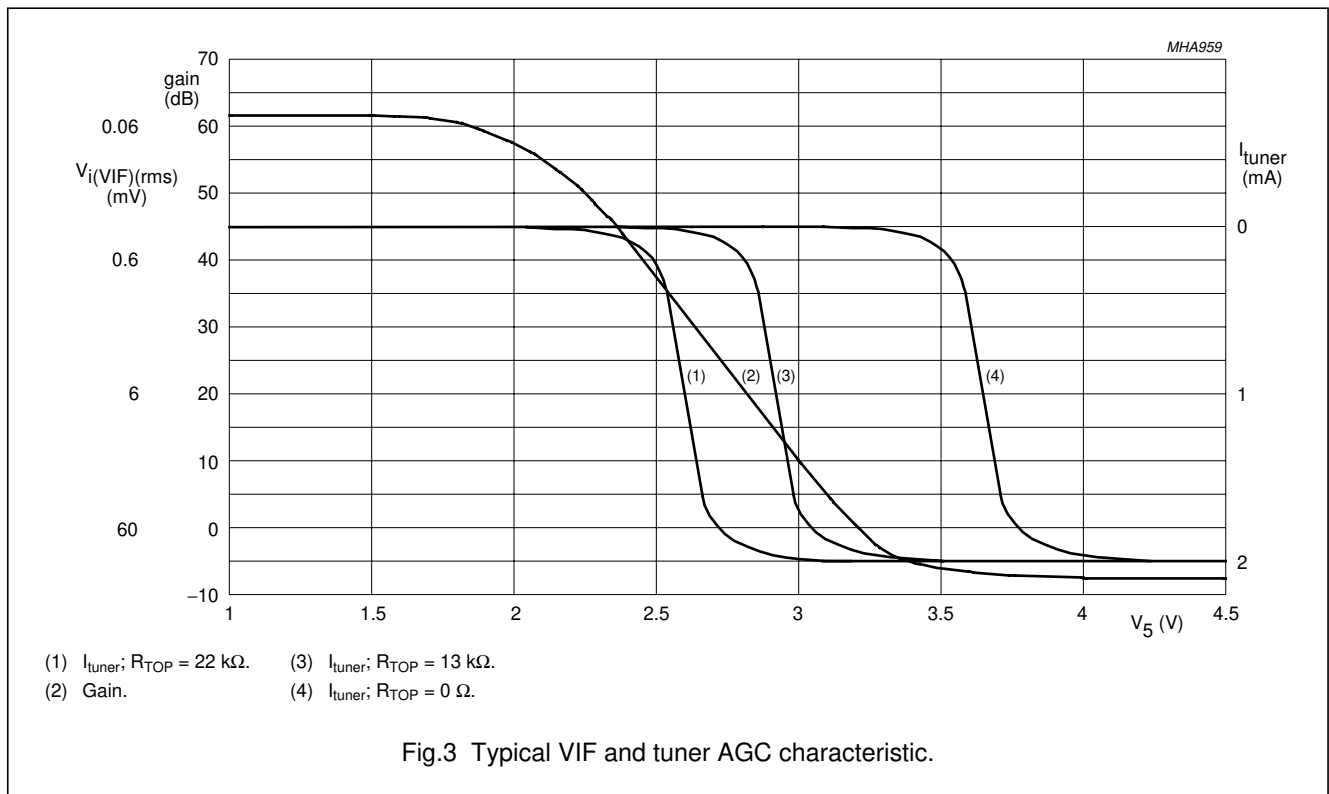

Single standard multimedia IF-PLL and FM radio demodulator

TDA9809M

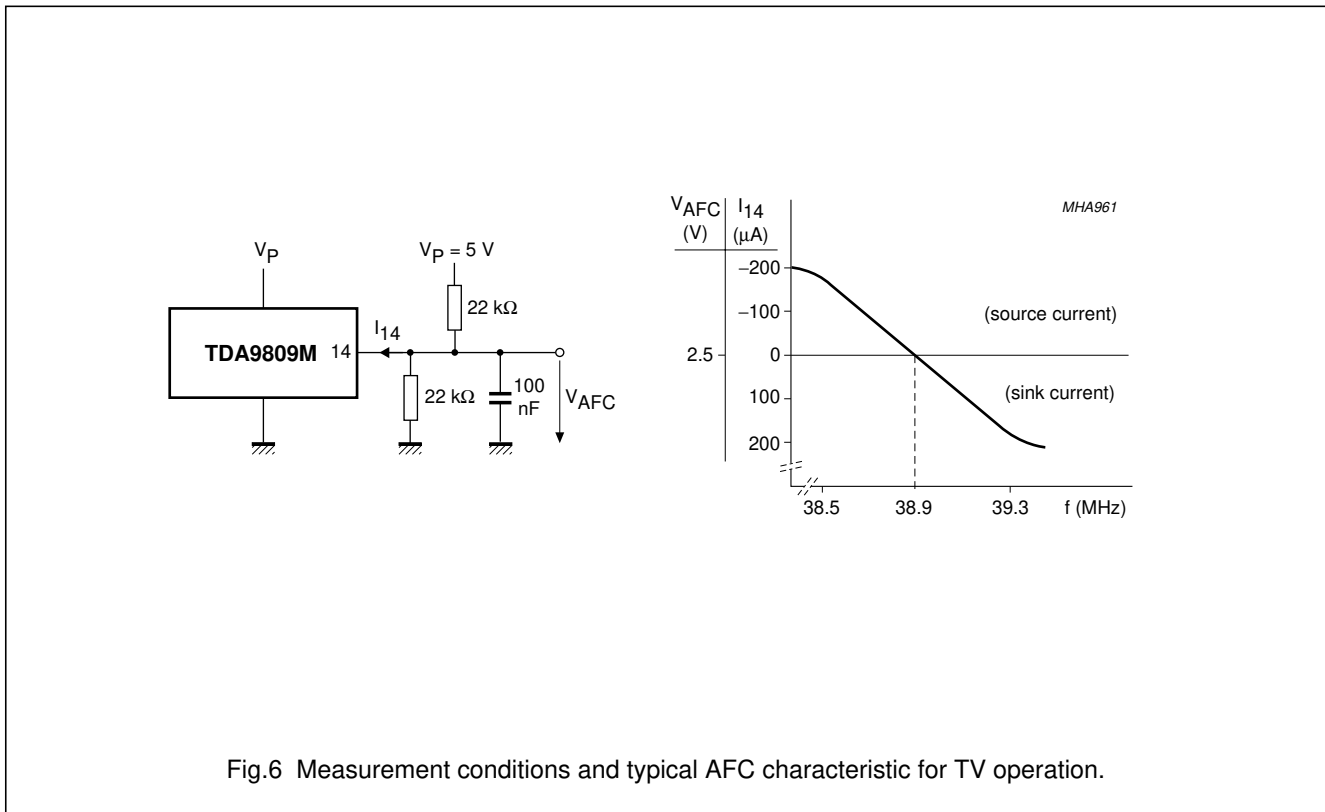
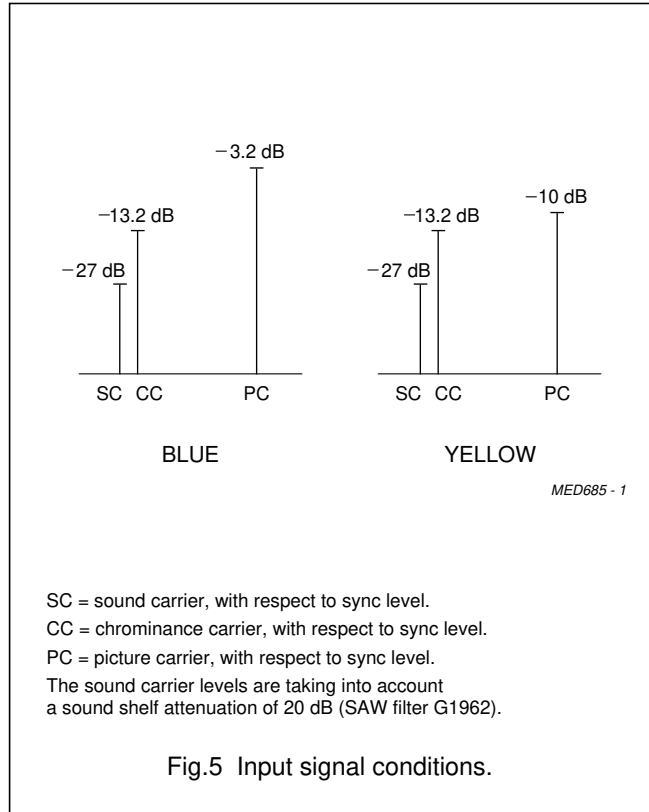
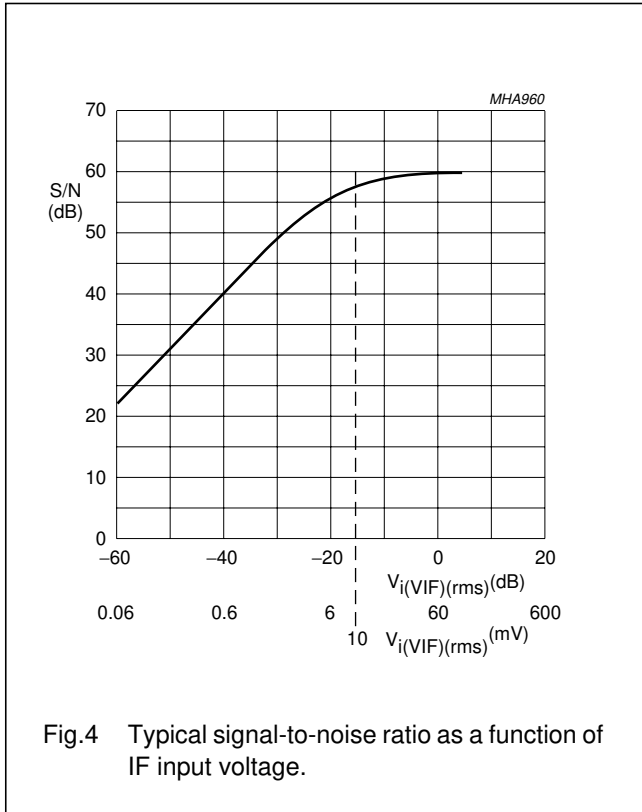

Single standard multimedia IF-PLL and FM radio demodulator

TDA9809M

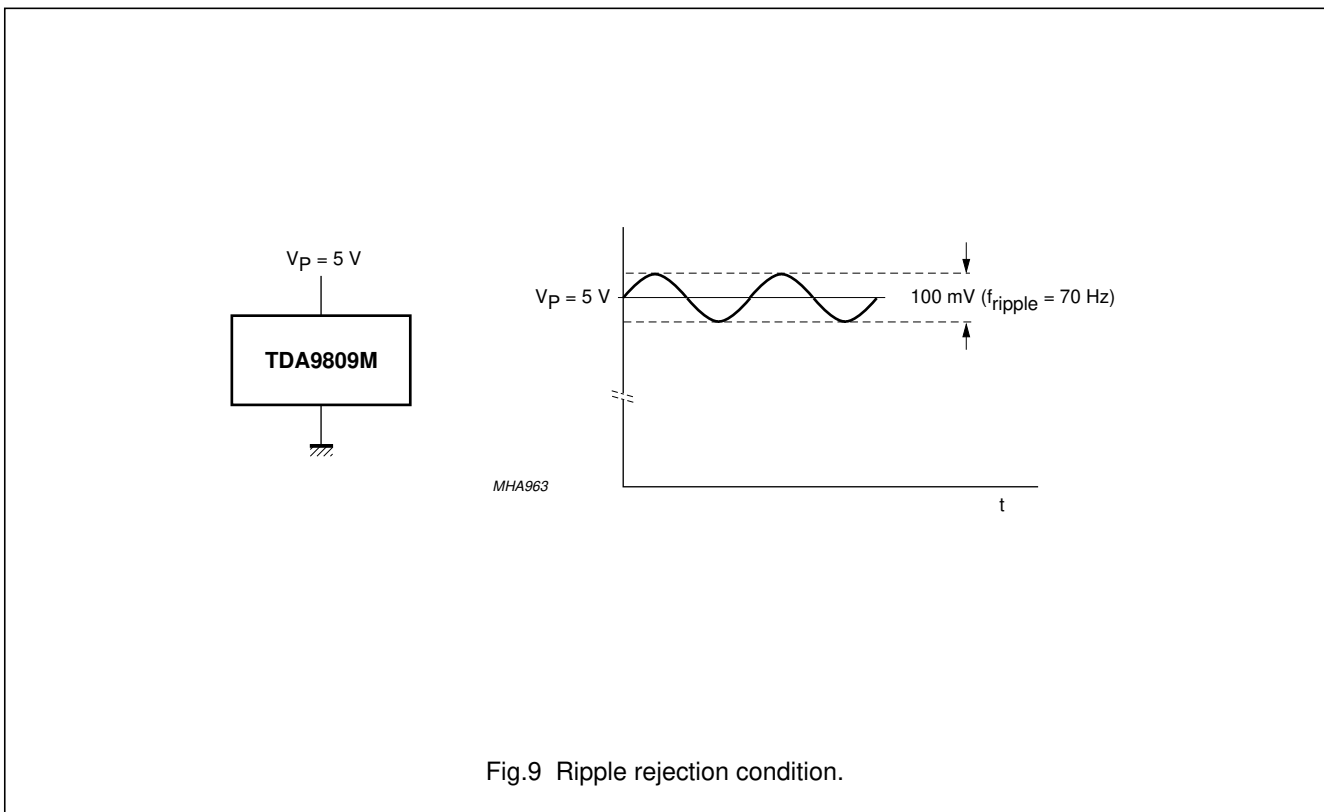
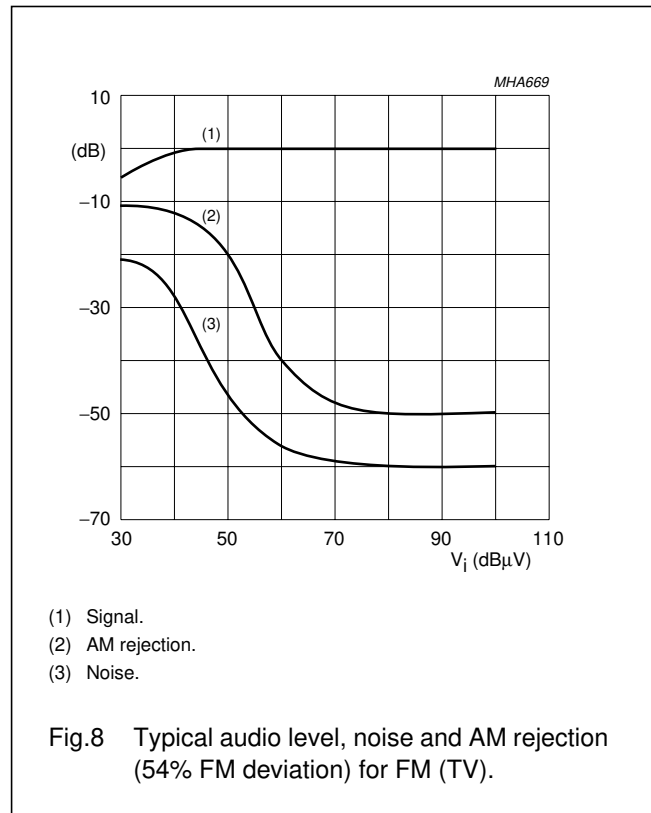
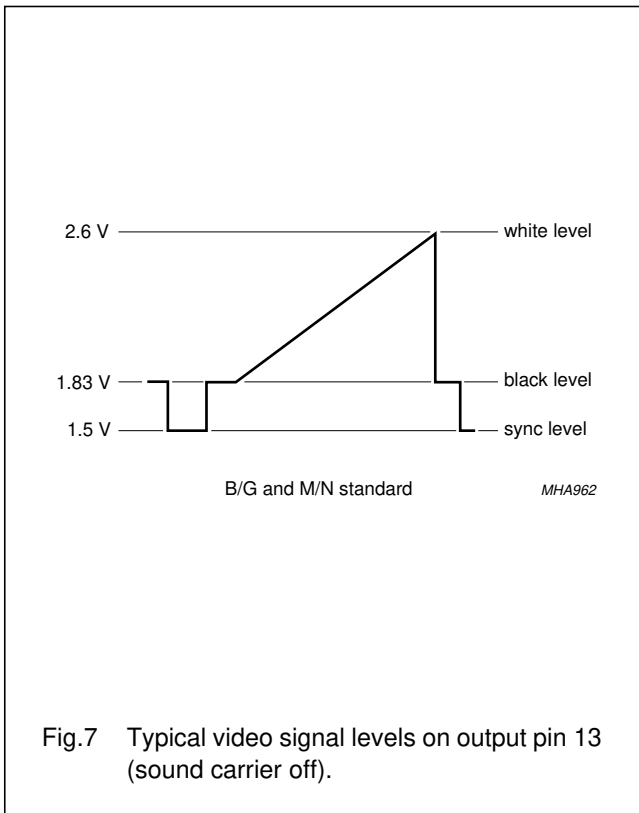

Single standard multimedia IF-PLL and FM radio demodulator

TDA9809M

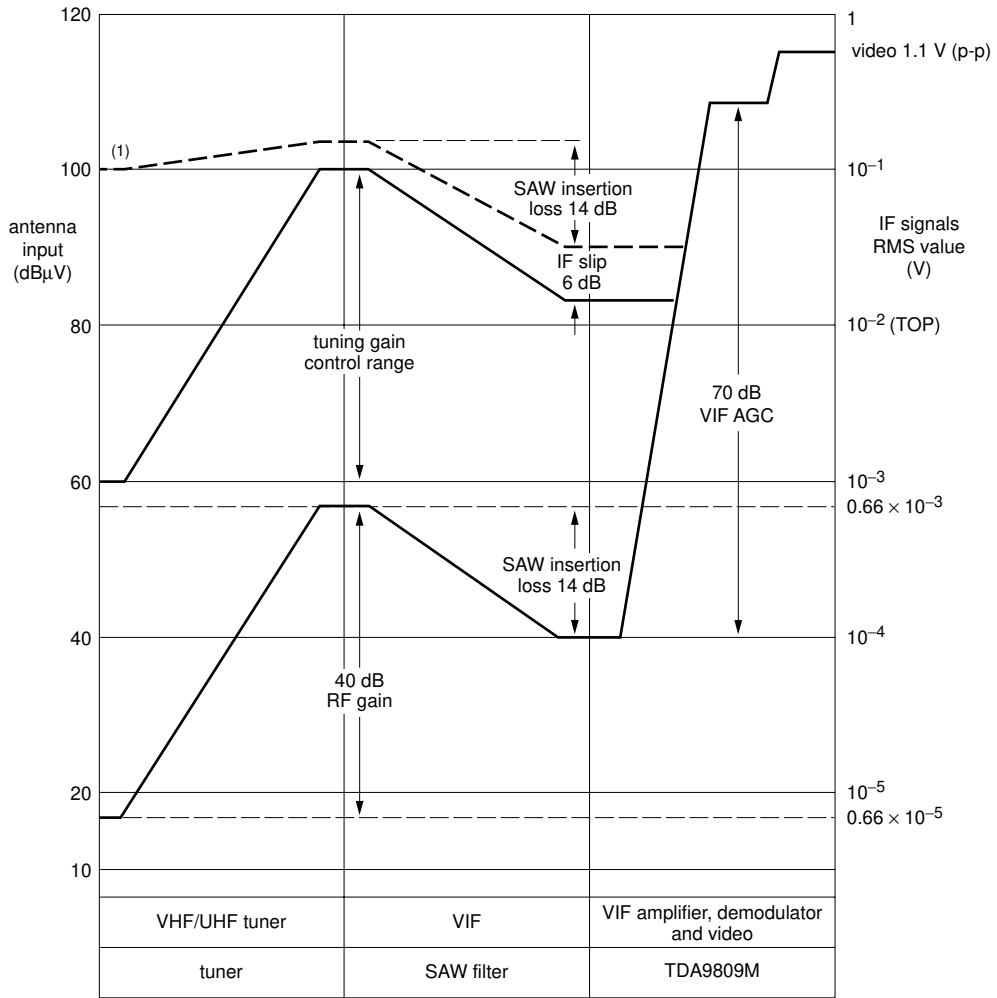

MHA964

(1) Depends on TOP.

Fig.10 Front-end level diagram for TV operation.

Single standard multimedia IF-PLL and FM radio demodulator

TDA9809M

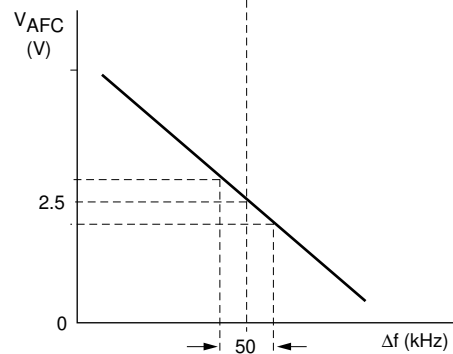
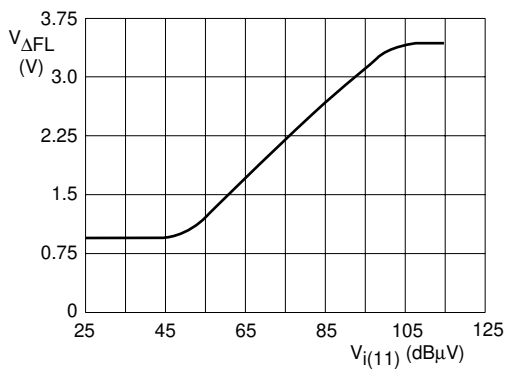
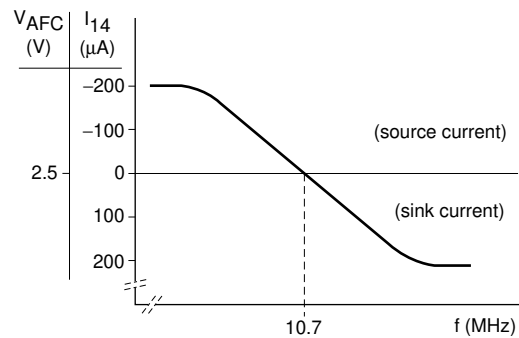
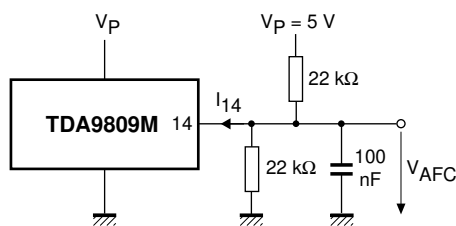

Typical level detector characteristic at radio operation

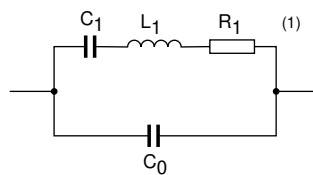

2-terminal type equivalent circuit of ceramic resonator

MHA965

- (1) Equivalent compliance $C_1 = 2.35 \text{ pF}$.
- Equivalent mass $L_1 = 101 \text{ } \mu\text{H}$.
- Equivalent resistance $R_1 = 55 \text{ } \Omega$.
- Parallel equivalent capacity $C_0 = 18 \text{ pF}$.

Fig.11 Measurement conditions and typical AFC characteristic for radio operation.

Single standard multimedia IF-PLL and FM
radio demodulator

TDA9809M

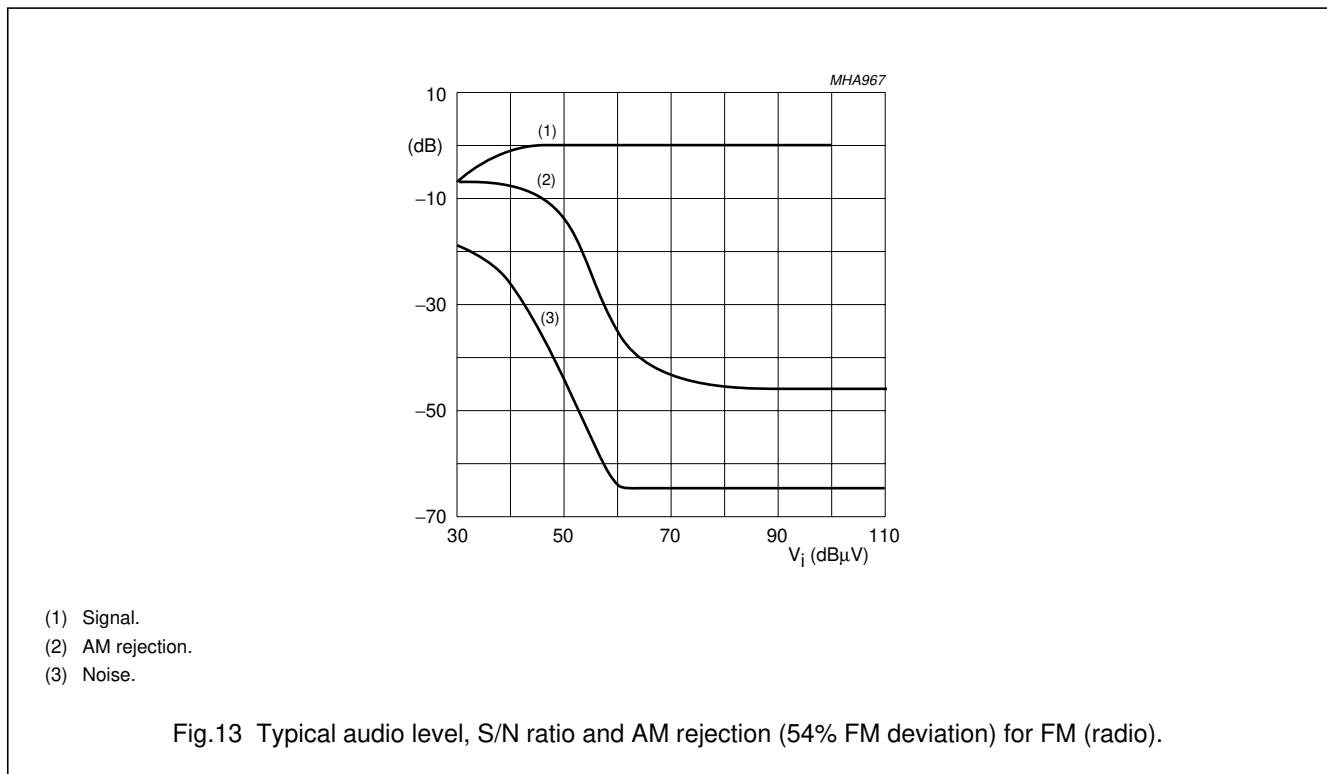
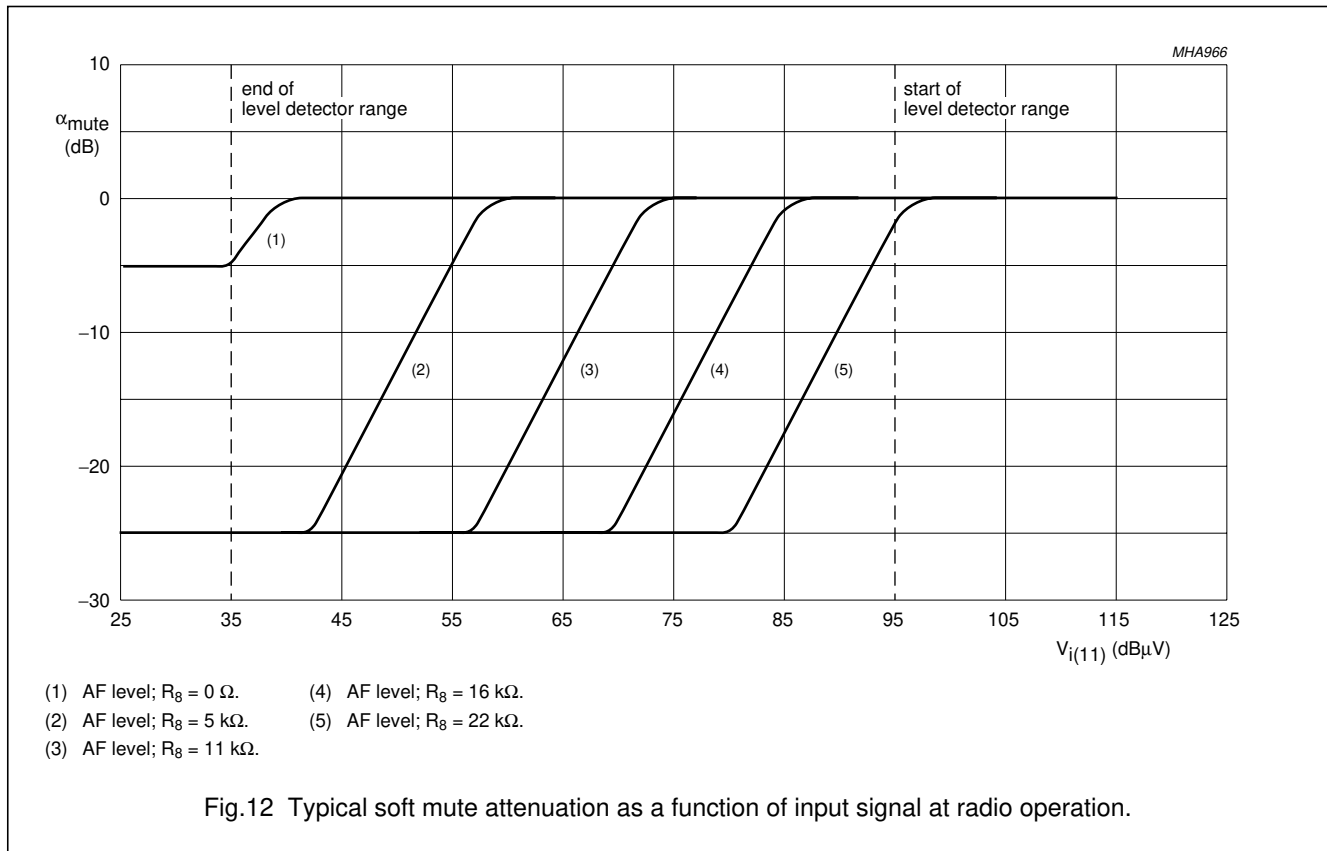

Single standard multimedia IF-PLL and FM
radio demodulator

TDA9809M

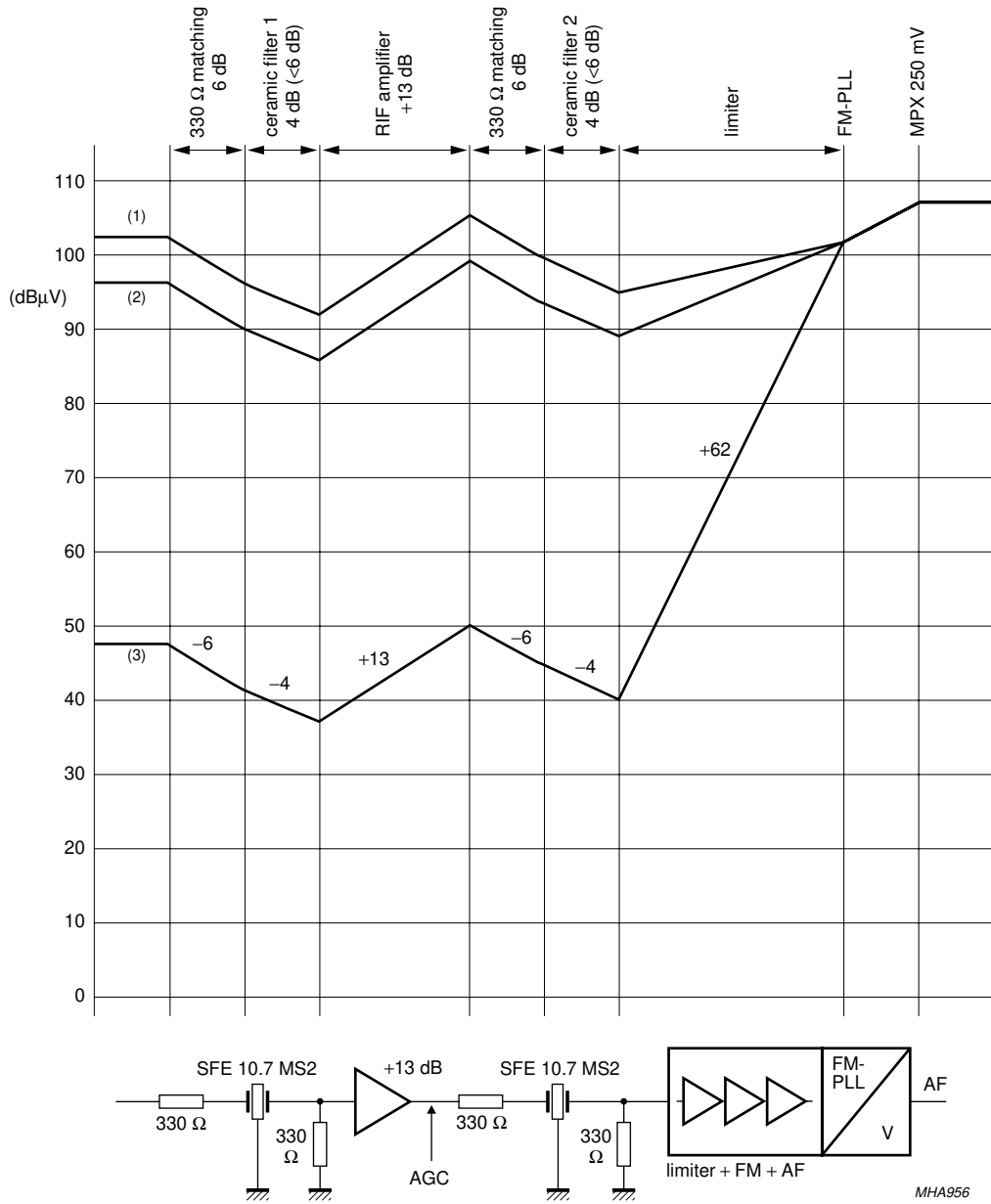

- (1) RF input 102 dBµV (onset of tuner AGC).
- (2) RF input 96 dBµV (signal condition for $d_3 < 60$ dB).
- (3) RF input 47 dBµV.

Fig.14 Front-end level diagram for radio operation.