



Chipsmall Limited consists of a professional team with an average of over 10 year of expertise in the distribution of electronic components. Based in Hongkong, we have already established firm and mutual-benefit business relationships with customers from,Europe,America and south Asia,supplying obsolete and hard-to-find components to meet their specific needs.

With the principle of “Quality Parts,Customers Priority,Honest Operation,and Considerate Service”,our business mainly focus on the distribution of electronic components. Line cards we deal with include Microchip,ALPS,ROHM,Xilinx,Pulse,ON,Everlight and Freescale. Main products comprise IC,Modules,Potentiometer,IC Socket,Relay,Connector.Our parts cover such applications as commercial,industrial, and automotives areas.

We are looking forward to setting up business relationship with you and hope to provide you with the best service and solution. Let us make a better world for our industry!



## Contact us

Tel: +86-755-8981 8866 Fax: +86-755-8427 6832

Email & Skype: info@chipsmall.com Web: www.chipsmall.com

Address: A1208, Overseas Decoration Building, #122 Zhenhua RD., Futian, Shenzhen, China



EconoPACK™4 Modul und PressFIT / NTC  
EconoPACK™4 module and PressFIT / NTC

**Vorläufige Daten / preliminary data**

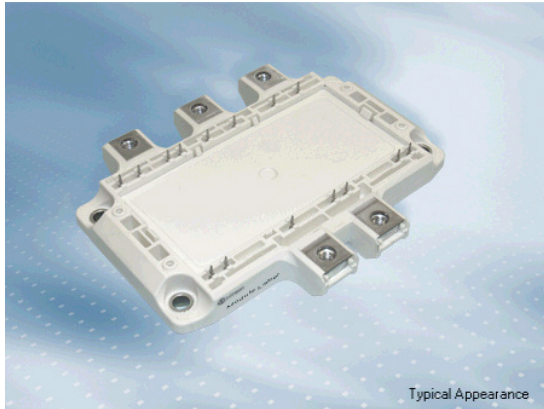

**V<sub>CES</sub> = 1600V**  
**I<sub>C nom</sub> = 360A / I<sub>CRM</sub> = 720A**

**Typische Anwendungen**

- Halbgesteuerte B6-Brücke
- Motorantriebe
- USV-Systeme

**Typical Applications**

- Half Controlled B6-bridge
- Motor Drives
- UPS Systems

**Mechanische Eigenschaften**

- 4 kV AC 1min Isolationsfestigkeit
- Integrierter NTC Temperatur Sensor
- Isolierte Bodenplatte
- PressFIT Verbindungstechnik

**Mechanical Features**

- 4 kV AC 1min Insulation
- Integrated NTC temperature sensor
- Isolated Base Plate
- PressFIT Contact Technology

**Module Label Code**

**Barcode Code 128**



**DMX - Code**



**Content of the Code**

**Digit**

Module Serial Number	1 - 5
Module Material Number	6 - 11
Production Order Number	12 - 19
Datecode (Production Year)	20 - 21
Datecode (Production Week)	22 - 23

prepared by: MK	date of publication: 2009-11-13	material no: 32242
approved by: RO	revision: 2.0	UL approved (E83335)

**Vorläufige Daten  
preliminary data**

**Diode-Gleichrichter / diode-rectifier**

**Höchstzulässige Werte / maximum rated values**

Periodische Rückw. Spitzensperrspannung repetitive peak reverse voltage	$T_{vj} = 25^{\circ}\text{C}$	$V_{RRM}$	1600	V
Durchlassstrom Grenzeffektivwert pro Dio. forward current RMS maximum per diode	$T_C = 80^{\circ}\text{C}$	$I_{FRMSM}$	210	A
Gleichrichter Ausgang Grenzeffektivstrom maximum RMS current at Rectifier output	$T_C = 80^{\circ}\text{C}$	$I_{RMSM}$	360	A
Stoßstrom Grenzwert surge forward current	$t_p = 10\text{ ms}, T_{vj} = 25^{\circ}\text{C}$ $t_p = 10\text{ ms}, T_{vj} = 150^{\circ}\text{C}$	$I_{FSM}$	2300 2100	A A
Grenzlastintegral $I^2t$ - value	$t_p = 10\text{ ms}, T_{vj} = 25^{\circ}\text{C}$ $t_p = 10\text{ ms}, T_{vj} = 150^{\circ}\text{C}$	$I^2t$	26500 22000	$\text{A}^2\text{s}$ $\text{A}^2\text{s}$

**Charakteristische Werte / characteristic values**

			min.	typ.	max.	
Durchlassspannung forward voltage	$T_{vj} = 150^{\circ}\text{C}, I_F = 210\text{ A}$	$V_F$		0,90		V
Sperrstrom reverse current	$T_{vj} = 150^{\circ}\text{C}, V_R = 1600\text{ V}$	$I_R$		1,40		mA
Innerer Wärmewiderstand thermal resistance, junction to case	pro Diode per diode	$R_{thJC}$			0,22	K/W
Übergangs-Wärmewiderstand thermal resistance, case to heatsink	pro Diode / per diode $\lambda_{paste} = 1\text{ W}/(\text{m}\cdot\text{K})$ / $\lambda_{grease} = 1\text{ W}/(\text{m}\cdot\text{K})$	$R_{thCH}$		0,069		K/W

prepared by: MK	date of publication: 2009-11-13
approved by: RO	revision: 2.0



**Vorläufige Daten**  
**preliminary data**

**Thyristor-Gleichrichter / thyristor-rectifier**

**Höchstzulässige Werte / maximum rated values**

Periodische Rückw. Spitzensperrspannung repetitive peak reverse voltage	$T_{vj} = 25^{\circ}\text{C}$	$V_{RRM}$	1600	V
Durchlaßstrom Grenzeffektivwert pro Chip forward current RMS maximum per chip	$T_C = 80^{\circ}\text{C}$	$I_{FRMSM}$	210	A
Gleichrichter Ausgang Grenzeffektivstrom maximum RMS current at Rectifier output	$T_C = 80^{\circ}\text{C}$	$I_{RMSmax}$	360	A
Stoßstrom Grenzwert surge forward current	$t_p = 10\text{ms}, T_{vj} = 25^{\circ}\text{C}$ $t_p = 10\text{ms}, T_{vj} = 130^{\circ}\text{C}$	$I_{FSM}$	3000 2700	A
Grenzlastintegral $I^2t$ - value	$t_p = 10\text{ms}, T_{vj} = 25^{\circ}\text{C}$ $t_p = 10\text{ms}, T_{vj} = 130^{\circ}\text{C}$	$I^2t$	45000 36500	$\text{A}^2\text{s}$
kritische Stromsteilheit critical rate of rise of on-state current	DIN IEC 60 754-6 $f = 50\text{Hz}, i_{GM} = 0,6\text{A}, di_G/dt = 0,6\text{A}/\mu\text{s}$	$(di/dt)_{cr}$	100	$\text{A}/\mu\text{s}$
kritische Spannungssteilheit critical rate of rise of on-state voltage	$T_{vj} = 130^{\circ}\text{C}, v_D = 0,67 V_{DRM}$	$(dv/dt)_{cr}$	1000	$\text{V}/\mu\text{s}$

**Charakteristische Werte / characteristic values**

			min.	typ.	max.	
Durchlaßspannung forward voltage	$T_{vj} = 130^{\circ}\text{C}, I_F = 210\text{A}$	$V_F$		1,05		V
Zündstrom gate trigger current	$T_{vj} = 25^{\circ}\text{C}, v_D = 12\text{V}$	$I_{GT}$			100	mA
Zündspannung gate trigger voltage	$T_{vj} = 25^{\circ}\text{C}, v_D = 12\text{V}$	$V_{GT}$			2,0	V
Nicht zündender Steuerstrom gate non-trigger current	$T_{vj} = 130^{\circ}\text{C}, v_D = 12\text{V}$ $T_{vj} = 130^{\circ}\text{C}, v_D = 0,5 V_{DRM}$	$I_{GD}$			6,0 3,0	mA
Nicht zündende Steuerspannung gate non-trigger voltage	$T_{vj} = 130^{\circ}\text{C}, v_D = 0,5 V_{DRM}$	$V_{GD}$			0,3	V
Haltestrom holding current	$T_{vj} = 25^{\circ}\text{C}, v_D = 12\text{V}, R_A = 5\ \Omega$	$I_H$			220	mA
Einraststrom latching current	$T_{vj} = 25^{\circ}\text{C}, v_D = 12\text{V}, R_{GK} \geq 20\ \Omega$ $i_{GM} = 0,6\text{A}, di_G/dt = 0,6\text{A}/\mu\text{s}, t_q = 20\ \mu\text{s}$	$I_L$			550	mA
Zündverzug gate controlled delay time	DIN IEC 747-6 $T_{vj} = 25^{\circ}\text{C}, i_{GM} = 0,6\text{A}, di_G/dt = 0,6\text{A}/\mu\text{s}$	$t_{gd}$			1,2	$\mu\text{s}$
Freiwerdezeit circuit commutated turn-off time	$T_{vj} = 130^{\circ}\text{C}, i_{TM} = 50\text{A}$ $V_{RM} = 100\text{V}, V_{DM} = 0,67 V_{DRM}$ $dv_D/dt = 20\text{V}/\mu\text{s}, -di_T/dt = 10\text{A}/\mu\text{s}$	$t_q$		150		$\mu\text{s}$
Sperrstrom reverse current	$T_{vj} = 130^{\circ}\text{C}, V_R = 1600\text{V}$	$I_{R_D}$	-	10,0		mA
Innerer Wärmewiderstand thermal resistance, junction to case	pro Thyristor per thyristor	$R_{thJC}$			0,14	K/W
Übergangs-Wärmewiderstand thermal resistance, case to heatsink	pro Thyristor / per thyristor $\lambda_{Paste} = 1\text{W}/(\text{m}\cdot\text{K}) / \lambda_{grease} = 1\text{W}/(\text{m}\cdot\text{K})$	$R_{thCH}$		0,044		K/W

prepared by: MK	date of publication: 2009-11-13
approved by: RO	revision: 2.0

**Vorläufige Daten**  
**preliminary data**

**NTC-Widerstand / NTC-thermistor**

**Charakteristische Werte / characteristic values**

			min.	typ.	max.	
Nennwiderstand rated resistance	$T_C = 25^\circ\text{C}$	$R_{25}$		5,00		k $\Omega$
Abweichung von $R_{100}$ deviation of $R_{100}$	$T_C = 100^\circ\text{C}$ , $R_{100} = 493 \Omega$	$\Delta R/R$	-5		5	%
Verlustleistung power dissipation	$T_C = 25^\circ\text{C}$	$P_{25}$			20,0	mW
B-Wert B-value	$R_2 = R_{25} \exp [B_{25/50}(1/T_2 - 1/(298,15 \text{ K}))]$	$B_{25/50}$		3375		K
B-Wert B-value	$R_2 = R_{25} \exp [B_{25/80}(1/T_2 - 1/(298,15 \text{ K}))]$	$B_{25/80}$		3411		K
B-Wert B-value	$R_2 = R_{25} \exp [B_{25/100}(1/T_2 - 1/(298,15 \text{ K}))]$	$B_{25/100}$		3433		K

Angaben gemäß gültiger Application Note.  
Specification according to the valid application note.

**Modul / module**

Isolations-Prüfspannung insulation test voltage	RMS, $f = 50 \text{ Hz}$ , $t = 1 \text{ min.}$	$V_{\text{ISOL}}$		4,0		kV
Material Modulgrundplatte material of module baseplate				Cu		
Material für innere Isolation material for internal insulation				$\text{Al}_2\text{O}_3$		
Kriechstrecke creepage distance	Kontakt - Kühlkörper / terminal to heatsink Kontakt - Kontakt / terminal to terminal			25,0 12,5		mm
Luftstrecke clearance distance	Kontakt - Kühlkörper / terminal to heatsink Kontakt - Kontakt / terminal to terminal			11,0 7,0		mm
Vergleichszahl der Kriechwegbildung comparative tracking index		CTI		> 200		
			min.	typ.	max.	
Übergangs-Wärmewiderstand thermal resistance, case to heatsink	pro Modul / per module $\lambda_{\text{Paste}} = 1 \text{ W}/(\text{m}\cdot\text{K})$ / $\lambda_{\text{grease}} = 1 \text{ W}/(\text{m}\cdot\text{K})$	$R_{\text{thCH}}$		0,009		K/W
Modulinduktivität stray inductance module		$L_{\text{sCE}}$		20		nH
Modulleitungswiderstand, Anschlüsse - Chip module lead resistance, terminals - chip	$T_C = 25^\circ\text{C}$ , pro Schalter / per switch	$R_{\text{CC}'+\text{EE}'}$		1,40		m $\Omega$
Höchstzulässige Sperrschichttemperatur maximum junction temperature	Wechselrichter, Brems-Chopper / Inverter, Brake-Chopper Gleichrichter / rectifier	$T_{\text{vj max}}$			130 130	$^\circ\text{C}$ $^\circ\text{C}$
Temperatur im Schaltbetrieb temperature under switching conditions	Wechselrichter, Brems-Chopper / Inverter, Brake-Chopper Gleichrichter / rectifier	$T_{\text{vj op}}$	-40 -40		130 130	$^\circ\text{C}$ $^\circ\text{C}$
Lagertemperatur storage temperature		$T_{\text{stg}}$	-40		125	$^\circ\text{C}$
Anzugsdrehmoment f. mech. Befestigung mounting torque	Schraube M5 - Montage gem. gültiger Applikation Note screw M5 - mounting according to valid application note	M	3,00	-	6,00	Nm
Anzugsdrehmoment f. elektr. Anschlüsse terminal connection torque	Schraube - Montage gem. gültiger Applikation Note screw - mounting according to valid application note	M		-	6,0	Nm
Gewicht weight		G		350		g

prepared by: MK	date of publication: 2009-11-13
approved by: RO	revision: 2.0



Vorläufige Daten  
preliminary data

Durchlasskennlinie der Diode-Gleichrichter (typisch)  
forward characteristic of diode-rectifier (typical)  
 $I_F = f(V_F)$

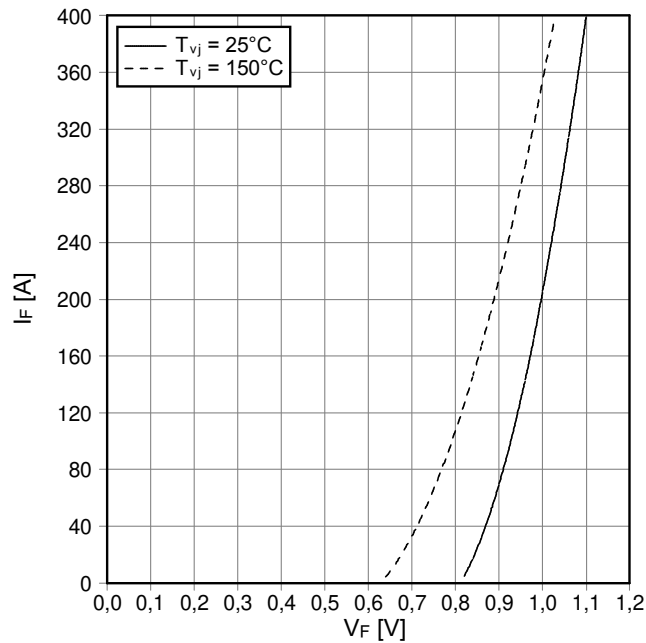

Durchlasskennlinie des Thyristors-Gleichrichter (typisch)  
forward characteristic of thyristor-rectifier (typical)  
 $I_T = f(V_T)$

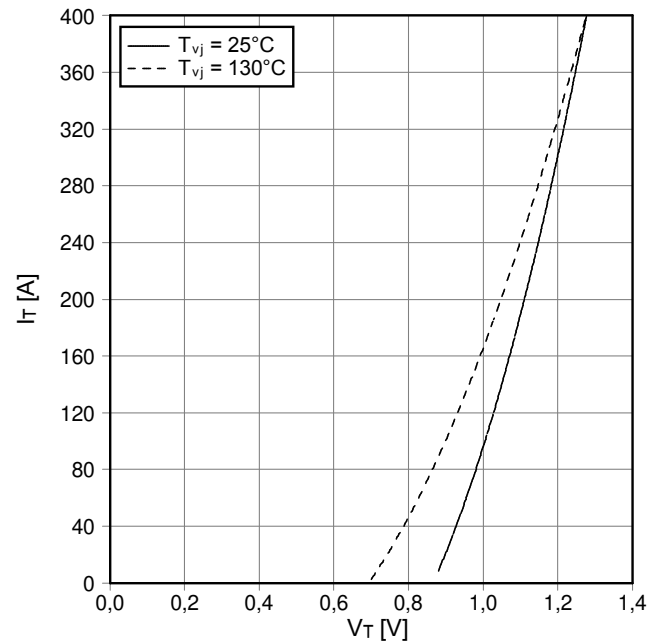

Transienter Wärmewiderstand Thyristor-Gleichrichter  
transient thermal impedance thyristor-rectifier  
 $Z_{thJC} = f(t)$

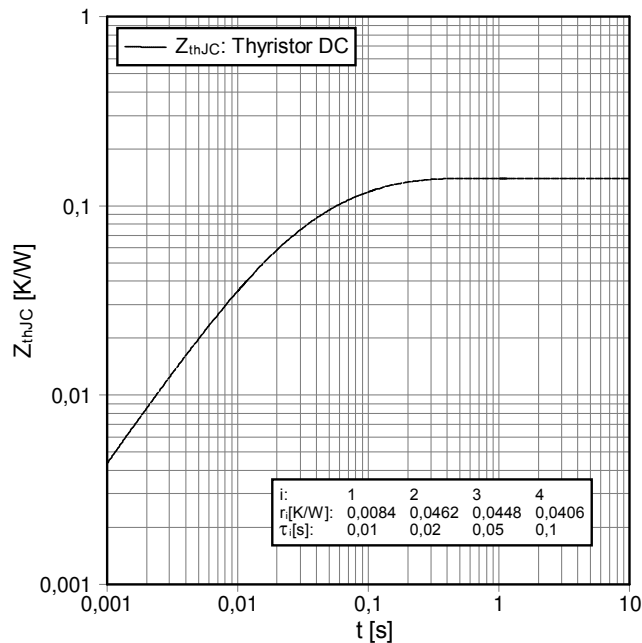

NTC-Temperaturkennlinie (typisch)  
NTC-temperature characteristic (typical)  
 $R = f(T)$

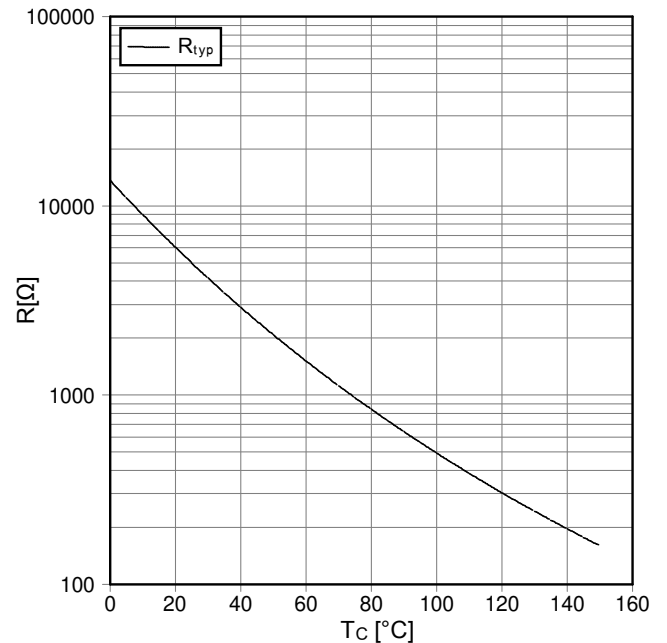

prepared by: MK	date of publication: 2009-11-13
approved by: RO	revision: 2.0

Schaltplan / circuit diagram

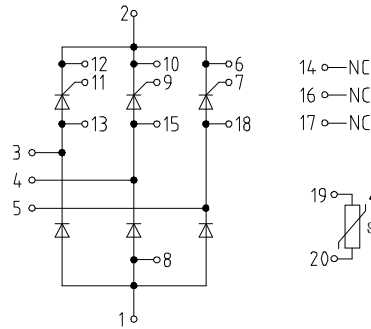

Gehäuseabmessungen / package outlines

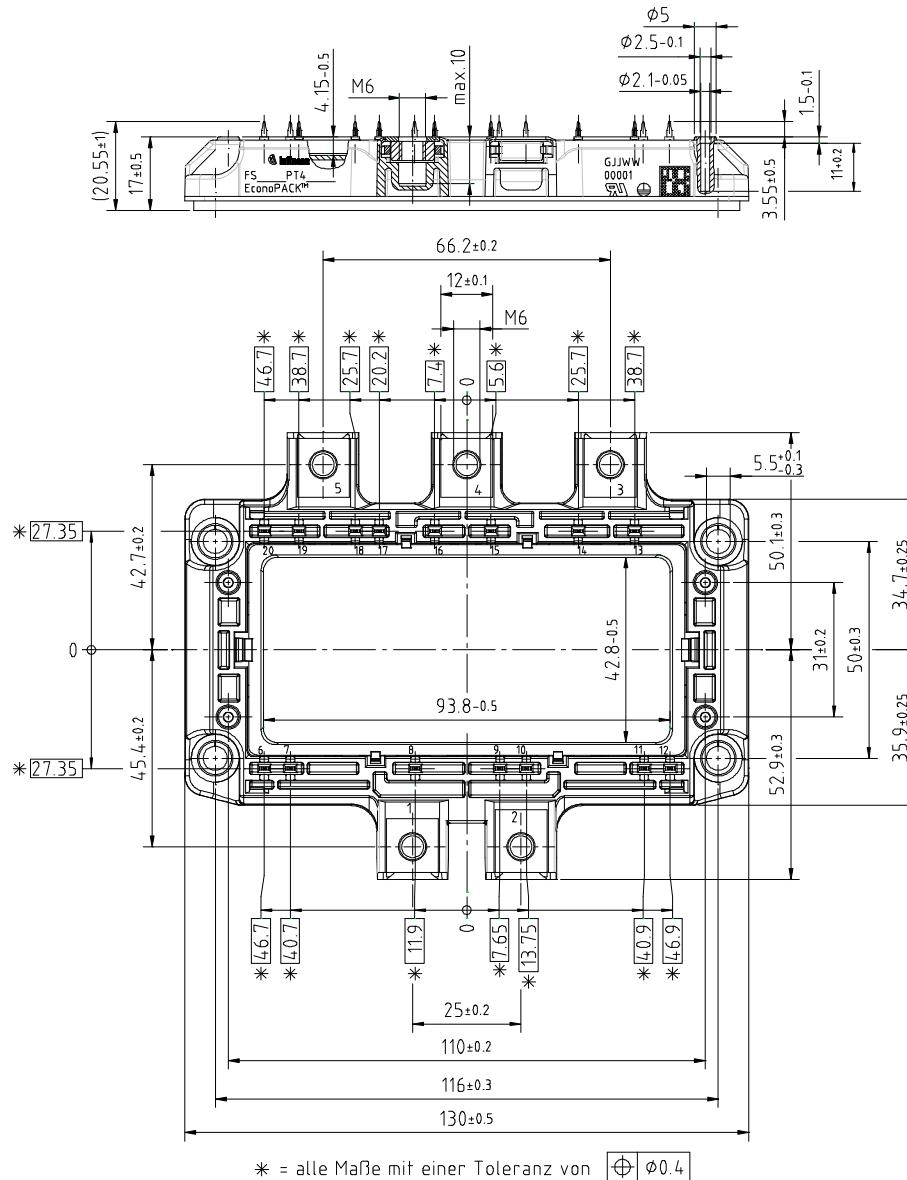

prepared by: MK  
approved by: RO

date of publication: 2009-11-13  
revision: 2.0



### **Nutzungsbedingungen**

Die in diesem Produktdatenblatt enthaltenen Daten sind ausschließlich für technisch geschultes Fachpersonal bestimmt. Die Beurteilung der Eignung dieses Produktes für Ihre Anwendung sowie die Beurteilung der Vollständigkeit der bereitgestellten Produktdaten für diese Anwendung obliegt Ihnen bzw. Ihren technischen Abteilungen.

In diesem Produktdatenblatt werden diejenigen Merkmale beschrieben, für die wir eine liefervertragliche Gewährleistung übernehmen. Eine solche Gewährleistung richtet sich ausschließlich nach Maßgabe der im jeweiligen Liefervertrag enthaltenen Bestimmungen. Garantien jeglicher Art werden für das Produkt und dessen Eigenschaften keinesfalls übernommen.

Sollten Sie von uns Produktinformationen benötigen, die über den Inhalt dieses Produktdatenblatts hinausgehen und insbesondere eine spezifische Verwendung und den Einsatz dieses Produktes betreffen, setzen Sie sich bitte mit dem für Sie zuständigen Vertriebsbüro in Verbindung (siehe [www.infineon.com](http://www.infineon.com), Vertrieb&Kontakt). Für Interessenten halten wir Application Notes bereit.

Aufgrund der technischen Anforderungen könnte unser Produkt gesundheitsgefährdende Substanzen enthalten. Bei Rückfragen zu den in diesem Produkt jeweils enthaltenen Substanzen setzen Sie sich bitte ebenfalls mit dem für Sie zuständigen Vertriebsbüro in Verbindung.

Sollten Sie beabsichtigen, das Produkt in Anwendungen der Luftfahrt, in gesundheits- oder lebensgefährdenden oder lebenserhaltenden Anwendungsbereichen einzusetzen, bitten wir um Mitteilung. Wir weisen darauf hin, dass wir für diese Fälle

- die gemeinsame Durchführung eines Risiko- und Qualitätsassessments;
- den Abschluss von speziellen Qualitätssicherungsvereinbarungen;
- die gemeinsame Einführung von Maßnahmen zu einer laufenden Produktbeobachtung dringend empfehlen und gegebenenfalls die Belieferung von der Umsetzung solcher Maßnahmen abhängig machen.

Soweit erforderlich, bitten wir Sie, entsprechende Hinweise an Ihre Kunden zu geben.

Inhaltliche Änderungen dieses Produktdatenblatts bleiben vorbehalten.

### **Terms & Conditions of usage**

The data contained in this product data sheet is exclusively intended for technically trained staff. You and your technical departments will have to evaluate the suitability of the product for the intended application and the completeness of the product data with respect to such application.

This product data sheet is describing the characteristics of this product for which a warranty is granted. Any such warranty is granted exclusively pursuant the terms and conditions of the supply agreement. There will be no guarantee of any kind for the product and its characteristics.

Should you require product information in excess of the data given in this product data sheet or which concerns the specific application of our product, please contact the sales office, which is responsible for you (see [www.infineon.com](http://www.infineon.com), sales&contact). For those that are specifically interested we may provide application notes.

Due to technical requirements our product may contain dangerous substances. For information on the types in question please contact the sales office, which is responsible for you.

Should you intend to use the Product in aviation applications, in health or live endangering or life support applications, please notify. Please note, that for any such applications we urgently recommend

- to perform joint Risk and Quality Assessments;
- the conclusion of Quality Agreements;
- to establish joint measures of an ongoing product survey, and that we may make delivery depended on the realization of any such measures.

If and to the extent necessary, please forward equivalent notices to your customers.

Changes of this product data sheet are reserved.

prepared by: MK	date of publication: 2009-11-13
approved by: RO	revision: 2.0