



Chipsmall Limited consists of a professional team with an average of over 10 year of expertise in the distribution of electronic components. Based in Hongkong, we have already established firm and mutual-benefit business relationships with customers from,Europe,America and south Asia,supplying obsolete and hard-to-find components to meet their specific needs.

With the principle of “Quality Parts,Customers Priority,Honest Operation,and Considerate Service”,our business mainly focus on the distribution of electronic components. Line cards we deal with include Microchip,ALPS,ROHM,Xilinx,Pulse,ON,Everlight and Freescale. Main products comprise IC,Modules,Potentiometer,IC Socket,Relay,Connector.Our parts cover such applications as commercial,industrial, and automotives areas.

We are looking forward to setting up business relationship with you and hope to provide you with the best service and solution. Let us make a better world for our industry!



Contact us

Tel: +86-755-8981 8866 Fax: +86-755-8427 6832

Email & Skype: info@chipsmall.com Web: www.chipsmall.com

Address: A1208, Overseas Decoration Building, #122 Zhenhua RD., Futian, Shenzhen, China





Thin-Film Directional Coupler

For 2400-2500MHz / 4900-5850MHz

TFSC06054125-2113A1X

0.65x0.5mm [EIA 0202]*

* Dimensions Code JIS[EIA]

Thin-Film Directional Coupler

Conformity to RoHS Directive

For 2400-2500MHz / 4900-5850MHz

TFSC06054125-2113A1X

SHAPES AND DIMENSIONS

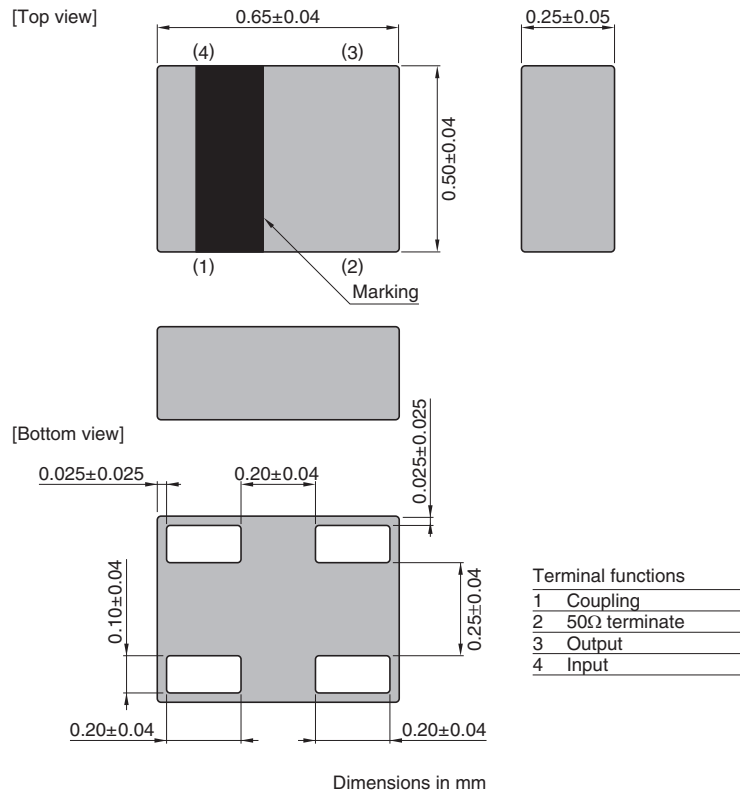

RECOMMENDED LAND PATTERN

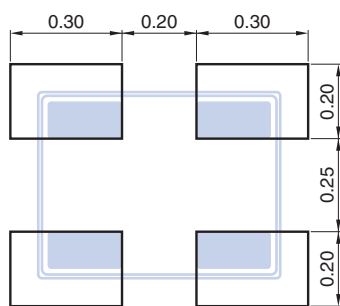

Line width be designed to match 50Ω characteristic impedance depending on PCB material and thickness.

○ RoHS Directive Compliant Product: See the following for more details. <https://product.tdk.com/info/en/environment/rohs/index.html>

- All specifications are subject to change without notice.
- Before using these products, be sure to request the delivery specifications.

TFSC06054125-2113A1X

ELECTRICAL CHARACTERISTICS

Item	Frequency Range (MHz)	Min.	Typ.	Max.
Coupling Factor (dB)	2400 to 2500	17.5	19.0	20.5
	4900 to 5850	11.0	12.5	14.0
Insertion Loss (dB)	2400 to 2500	—	0.11	0.25
	4900 to 5850	—	0.41	0.50
Return Loss (dB)	2400 to 2500	17.69	27.3	—
	4900 to 5850	17.69	20.8	—
Directivity (dB)	2400 to 2500	15	21.5	—
	4900 to 5850	15	21.3	—
Characteristic Impedance (Ω)			50 (Nominal)	

· Ta: +25°C

TEMPERATURE RANGE

Operating temperature (°C)	Storage temperature (°C)
-40 to +85	-40 to +85

MSL

Moisture Sensitivity Level (MSL)
1

- All specifications are subject to change without notice.
- Before using these products, be sure to request the delivery specifications.

TFSC06054125-2113A1X

FREQUENCY CHARACTERISTICS

INSERTION LOSS

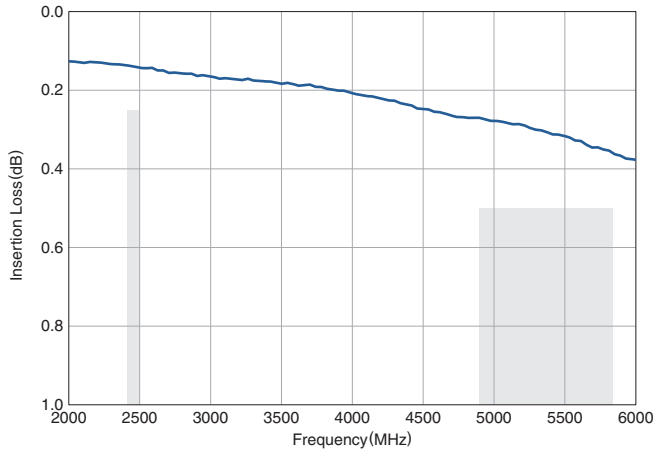

COUPLING

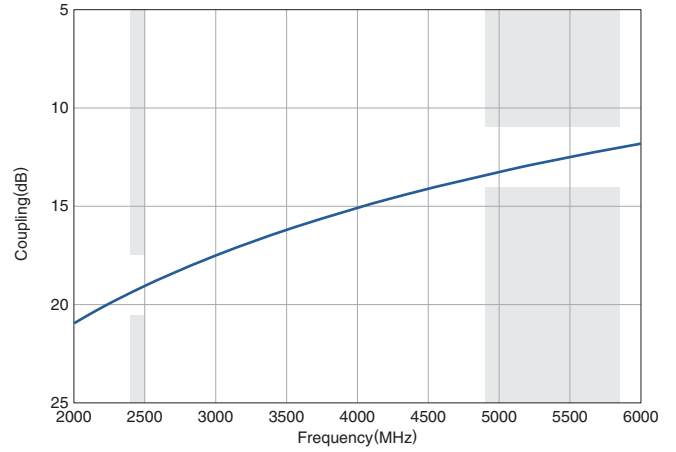

RETURN LOSS

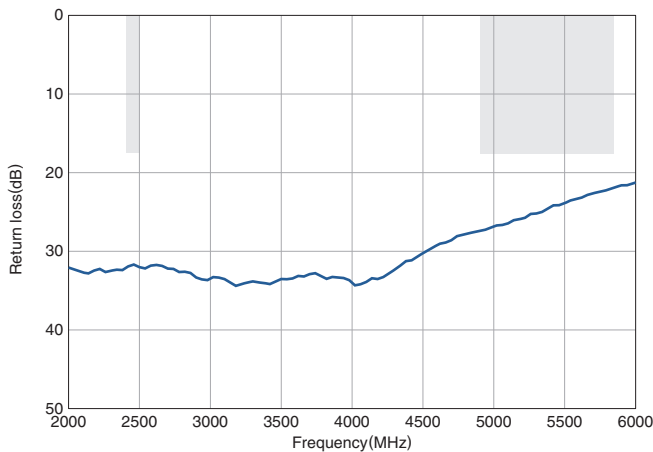

ISOLATION

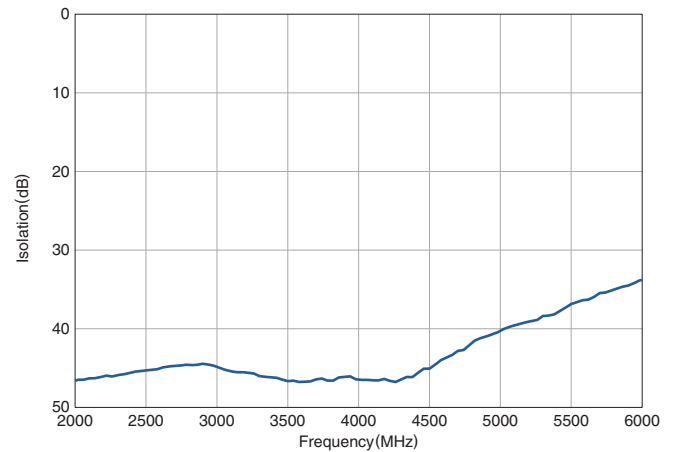

DIRECTIVITY

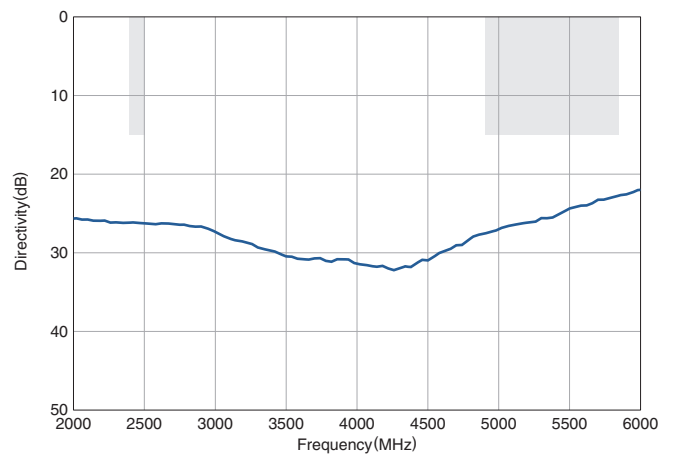

- All specifications are subject to change without notice.
- Before using these products, be sure to request the delivery specifications.

TFSC06054125-2113A1X

PACKAGING STYLE

REEL DIMENSIONS

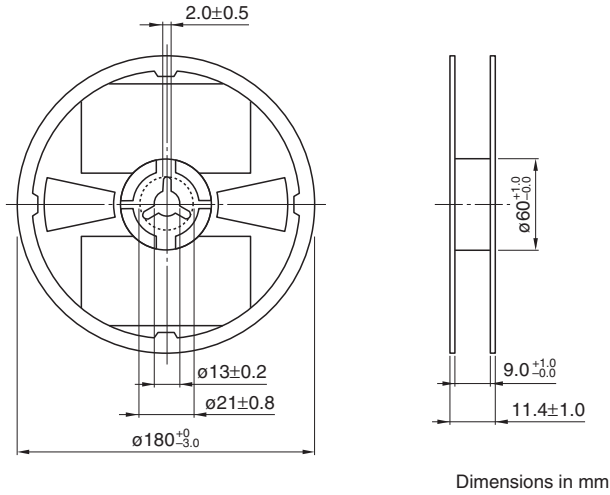

TAPE DIMENSIONS

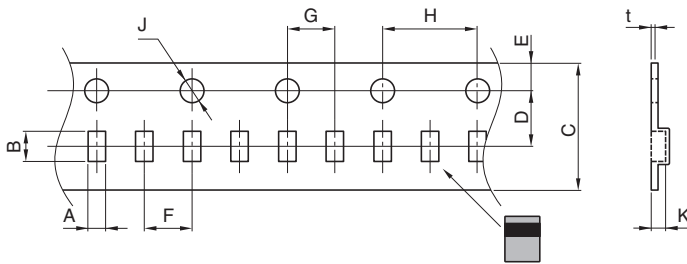

Dimensions in mm

A	B	C	D	E	F	G	H	J	K	t
0.63 ± 0.03	0.81 ± 0.03	8.0 ± 0.2	3.5 ± 0.05	1.75 ± 0.1	2.0 ± 0.05	2.0 ± 0.05	4.0 ± 0.1	$1.5 + 0.1 / - 0$	0.34 ± 0.03	0.20 ± 0.05

PACKAGE QUANTITY

Standard package quantity
(pieces/reel)

10,000

- All specifications are subject to change without notice.
- Before using these products, be sure to request the delivery specifications.

TFSC06054125-2113A1X

RECOMMENDED REFLOW PROFILE

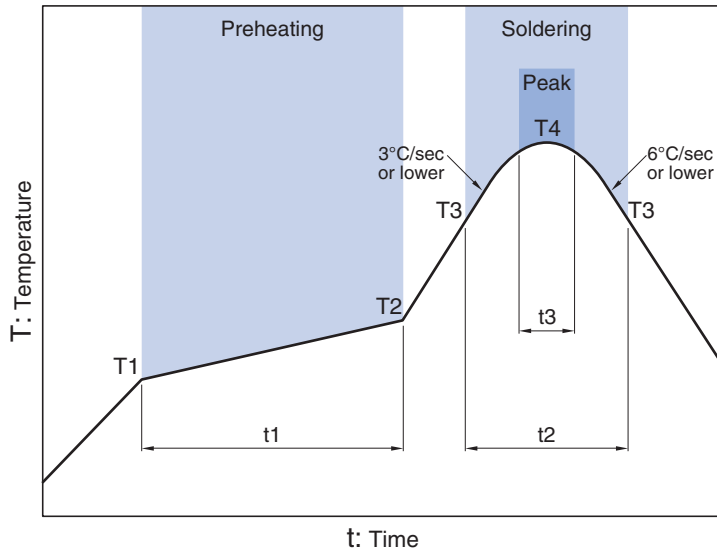

Preheating			Soldering			
Temp.	Temp.	Time	Critical zone (T3 to T4)		Temp.	Time
T1	T2	t1	T3	t2	T4	t3*
150°C	200°C	60 to 120sec	217°C	60 to 120sec	240 to 260°C	30sec max.

* t3 : Time within 5°C of actual peak temperature
The maximum number of reflow is 3.

REMINDERS FOR USING THESE PRODUCTS

Before using these products, be sure to request the delivery specifications.

SAFETY REMINDERS

Please pay sufficient attention to the warnings for safe designing when using these products.

REMINDERS

The products listed on this catalog are intended for use in general electronic equipment (AV equipment, telecommunications equipment, home appliances, amusement equipment, computer equipment, personal equipment, office equipment, measurement equipment, industrial robots) under a normal operation and use condition.

The products are not designed or warranted to meet the requirements of the applications listed below, whose performance and/or quality require a more stringent level of safety or reliability, or whose failure, malfunction or trouble could cause serious damage to society, person or property.

Please understand that we are not responsible for any damage or liability caused by use of the products in any of the applications below or for any other use exceeding the range or conditions set forth in this catalog.

- | | |
|---|--|
| (1) Aerospace/Aviation equipment | (8) Public information-processing equipment |
| (2) Transportation equipment (cars, electric trains, ships, etc.) | (9) Military equipment |
| (3) Medical equipment | (10) Electric heating apparatus, burning equipment |
| (4) Power-generation control equipment | (11) Disaster prevention/crime prevention equipment |
| (5) Atomic energy-related equipment | (12) Safety equipment |
| (6) Seabed equipment | (13) Other applications that are not considered general-purpose applications |
| (7) Transportation control equipment | |

When using this product in general-purpose applications, you are kindly requested to take into consideration securing protection circuit/equipment or providing backup circuits, etc., to ensure higher safety.