



Chipsmall Limited consists of a professional team with an average of over 10 year of expertise in the distribution of electronic components. Based in Hongkong, we have already established firm and mutual-benefit business relationships with customers from,Europe,America and south Asia,supplying obsolete and hard-to-find components to meet their specific needs.

With the principle of “Quality Parts,Customers Priority,Honest Operation,and Considerate Service”,our business mainly focus on the distribution of electronic components. Line cards we deal with include Microchip,ALPS,ROHM,Xilinx,Pulse,ON,Everlight and Freescale. Main products comprise IC,Modules,Potentiometer,IC Socket,Relay,Connector.Our parts cover such applications as commercial,industrial, and automotives areas.

We are looking forward to setting up business relationship with you and hope to provide you with the best service and solution. Let us make a better world for our industry!



Contact us

Tel: +86-755-8981 8866 Fax: +86-755-8427 6832

Email & Skype: info@chipsmall.com Web: www.chipsmall.com

Address: A1208, Overseas Decoration Building, #122 Zhenhua RD., Futian, Shenzhen, China



SPECIFICATION

- Part No. : **TG.22.0222**
- Product Name : 2G/3G Penta-Band Cellular Connector Mount Monopole Antenna
For Sierra Wireless Airlink GL Series Module
824MHz~2170MHz
- Features : Omni-Directional
Robust and Compact
0dBi Gain on lower bands, 4dBi on higher bands
FME(F) Right Angle
45*24.7*7.8 mm
RoHS Compliant



1. INTRODUCTION

The TG.22.0222 824MHz to 2170MHz monopole antenna is a quality robust antenna with high gain in small form factor.

Connection is made via right angle FME(F) connector with a hardened TPEE casing, this antenna is the ideal for remote monitoring devices or telematics applications. The TG.22.0222 antenna has been tuned specifically for optimum efficiency when connected directly to the Sierra Wireless Airlink GL series programmable module.

2. SPECIFICATION

ELECTRICAL

Standard	GSM Penta-Band				
	824-896	880-960	1710-1880	1850-1990	1920-2170
Operation Frequency (MHz)	824-896	880-960	1710-1880	1850-1990	1920-2170
Polarization	Linear				
Impedance	50 ohm				
VSWR	3:1	3:1	2:1	2:1	2:1
Return Loss (dB)	<-5dB	<-8dB	<-10dB	<-10dB	<-10dB
Efficiency (%)	51.37	49.71	74.64	80.57	76.56
Gain (dBi)	-0.04	-0.03	3.98	4.61	4.61
Average Gain (dB)	-2.91	-3.07	-1.28	-0.94	-1.17
Max Input Power	5W				

* The TG.22.0222 antenna performance was measured on a 62*46.5 mm evaluation board

MECHANICAL

Dimensions (mm)	45x24.7x.7.8
Required Space (mm)	45x24.7x.7.8
Material	TPEE
Connector	FME(F)RA
Weight	0.05Kg
Recommended Torque for Mounting	0.78N·m
Max Torque for Mounting	1.47N·m

ENVIRONMENTAL

Operation Temperature	-40°C to 85°C
Storage Temperature	-40°C to 85°C
Relative Humidity	40% to 95%
RoHs Compliant	Yes

3. TEST SET UP

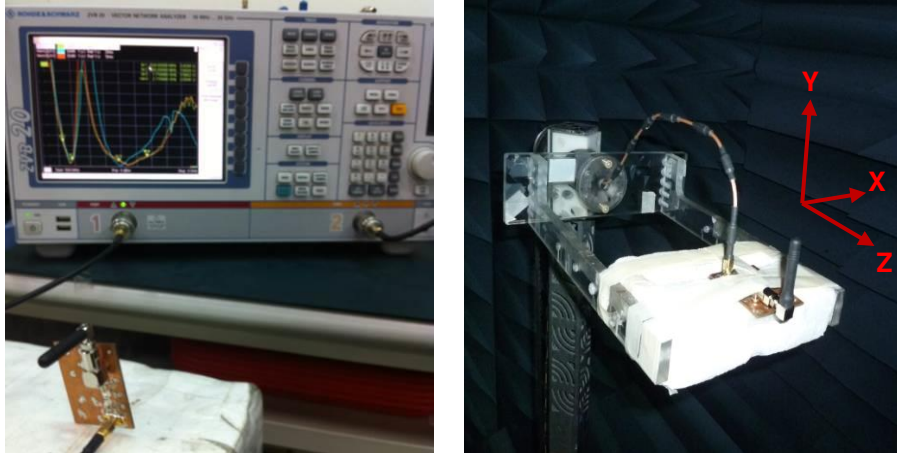

Figure 1. Impedance measurements (left hand) and peak gain, efficiency and radiation pattern measurements (right hand).

4. ANTENNA PARAMETERS

4.1. Return Loss

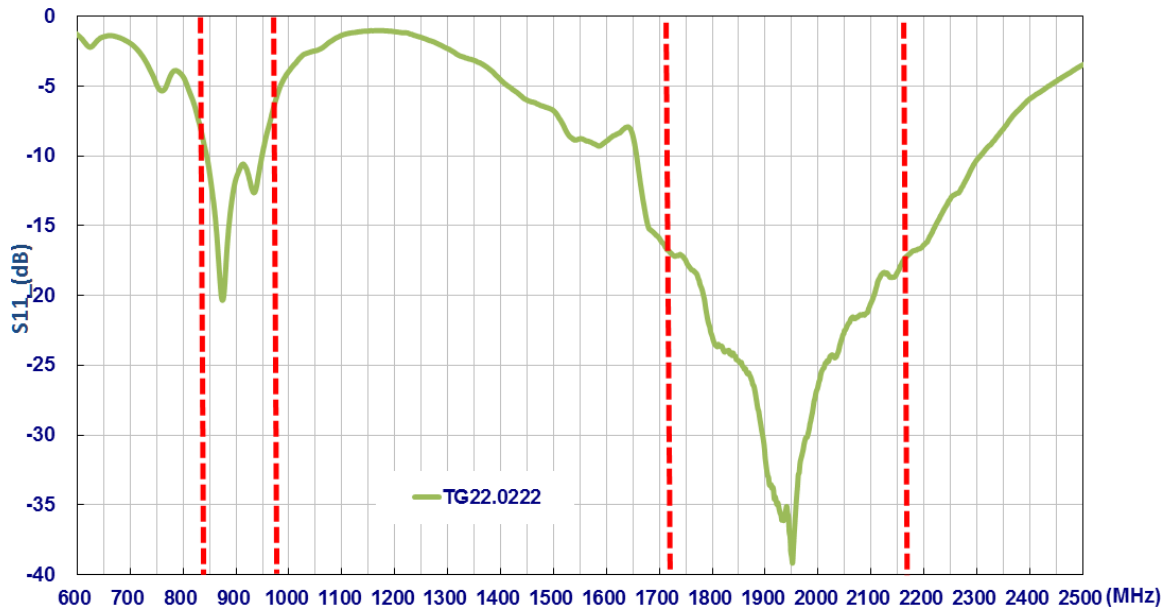

Figure 2. Return loss of the TG.22 antenna.

4.2. Efficiency

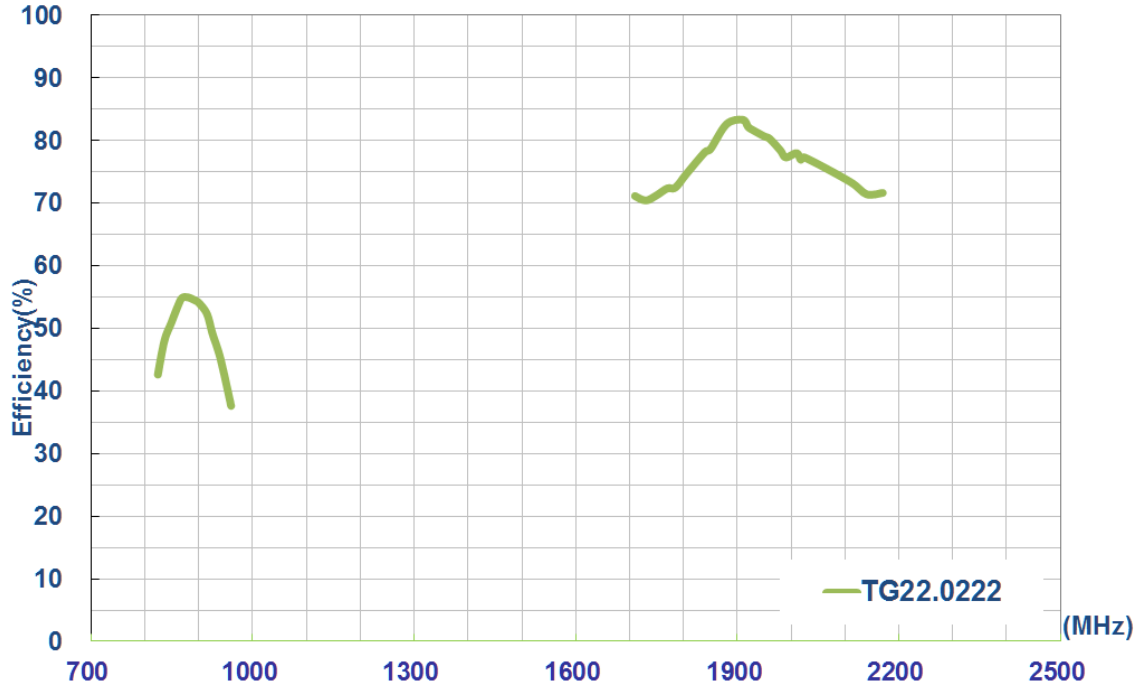

Figure 3. Efficiency of the TG.22 antenna.

4.3. Peak Gain

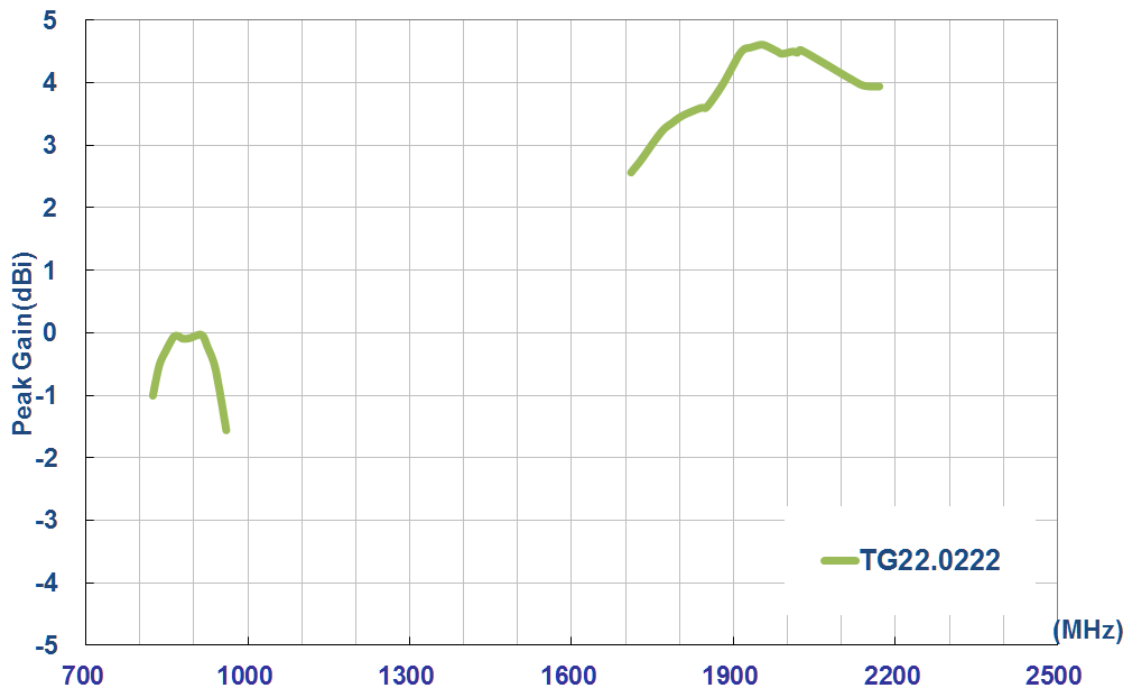

Figure 4. Peak Gain of the TG.22 Antenna.

4.4. Average Gain

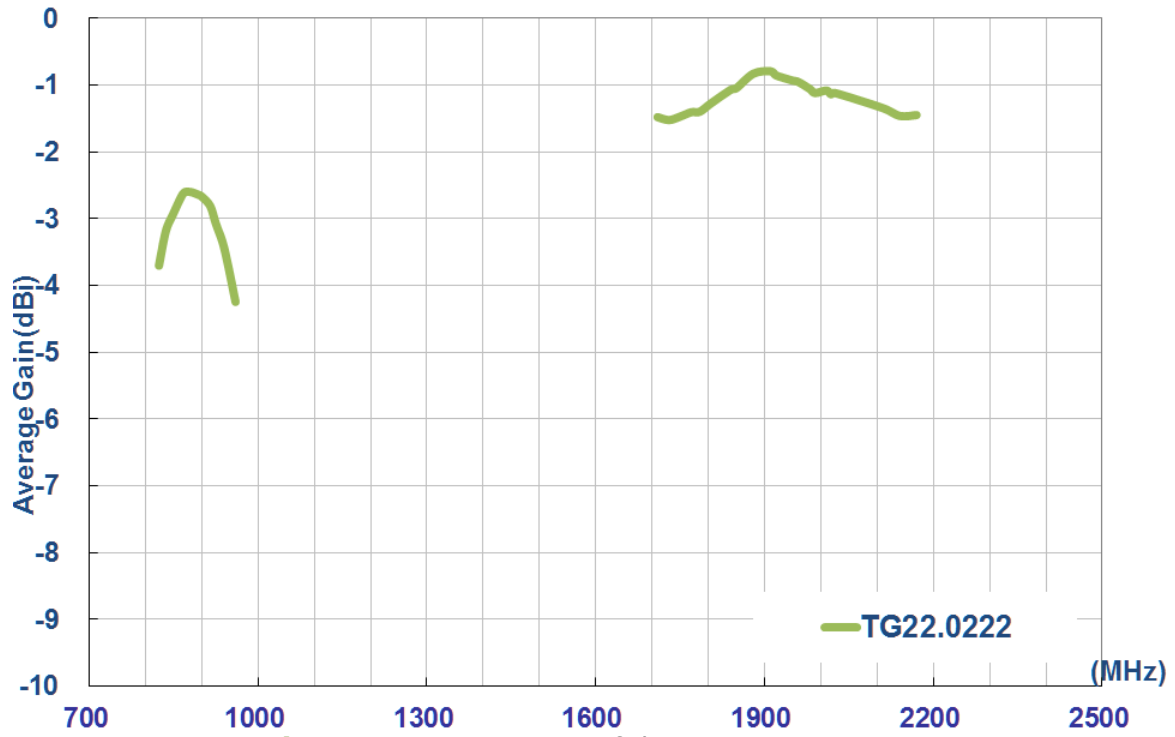
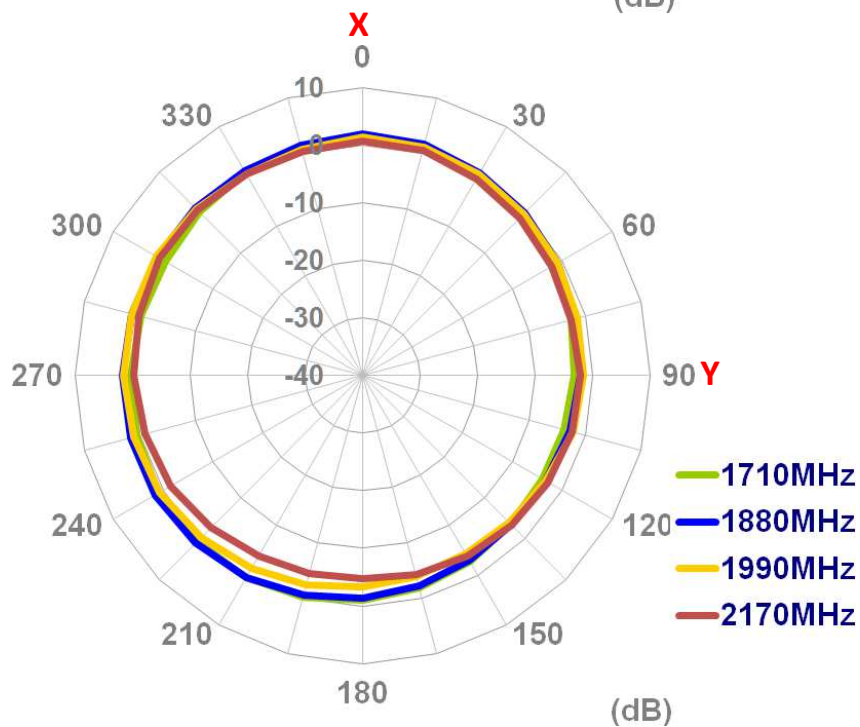
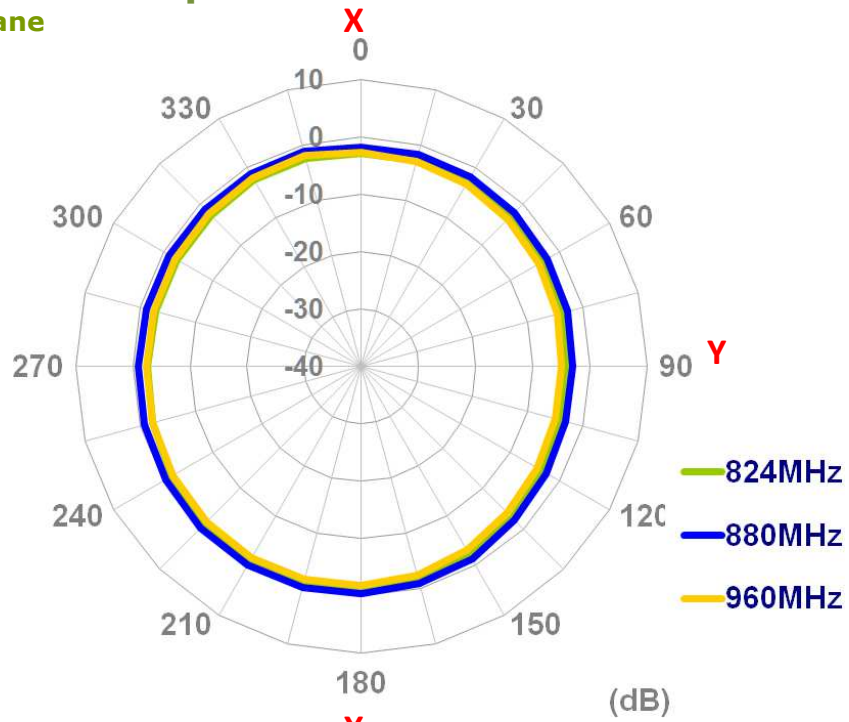

Figure 5. Average Gain of the TG.22 Antenna.

5. Antenna Radiation Patterns

5.1. 2D Radiation pattern XY-Plane



XZ-Plane

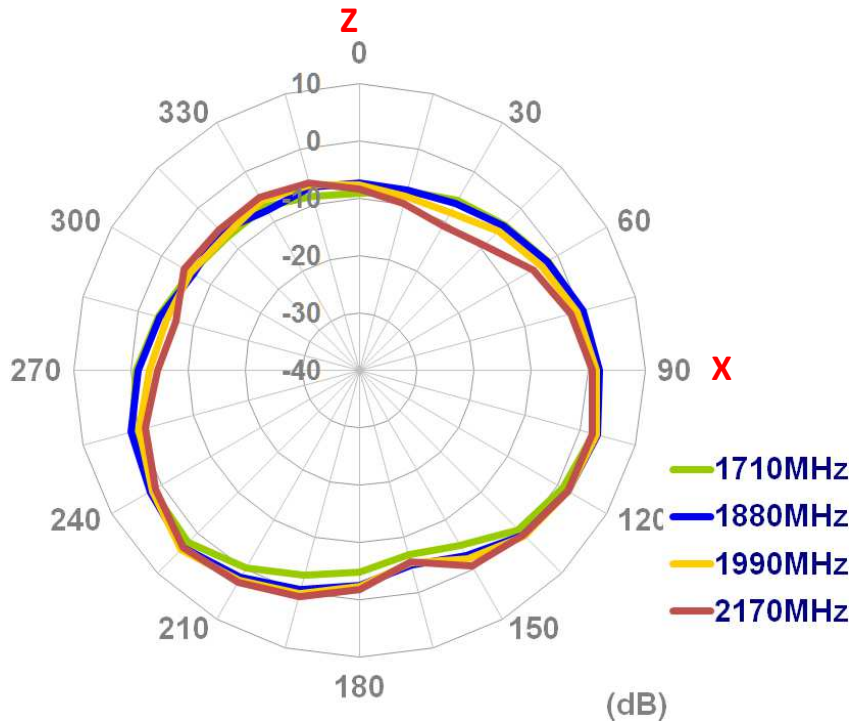
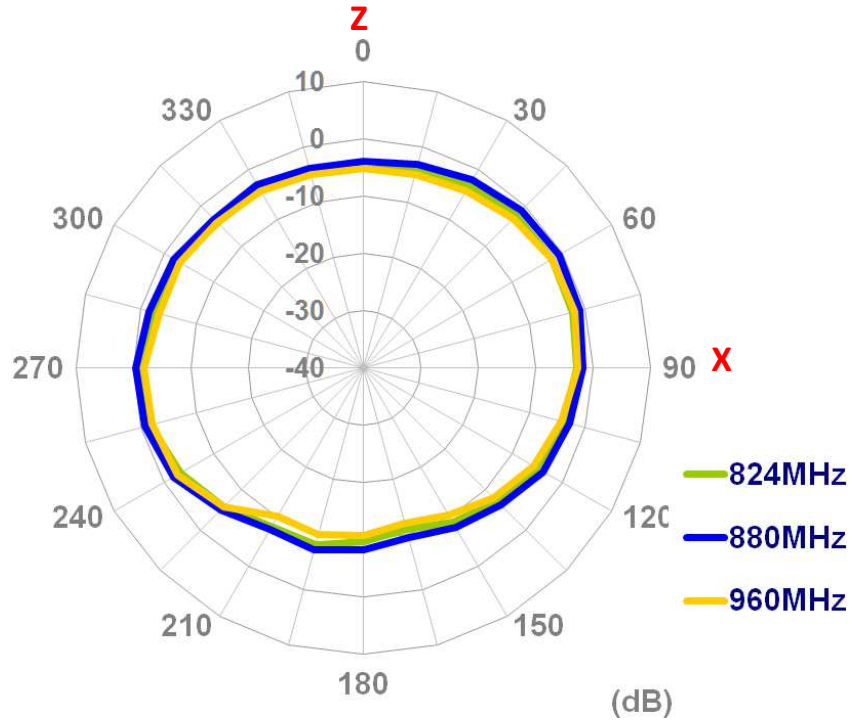

YZ-Plane

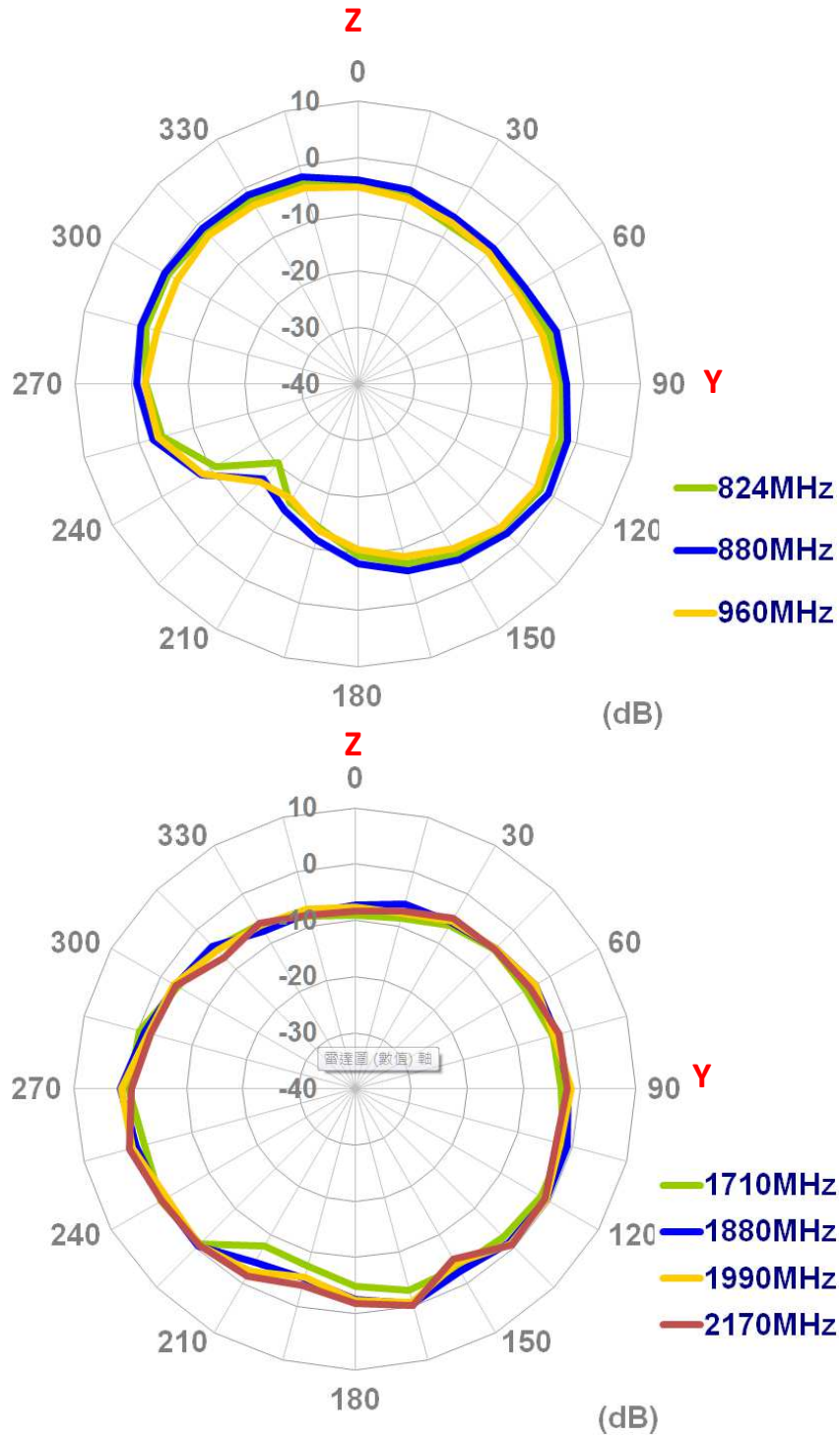
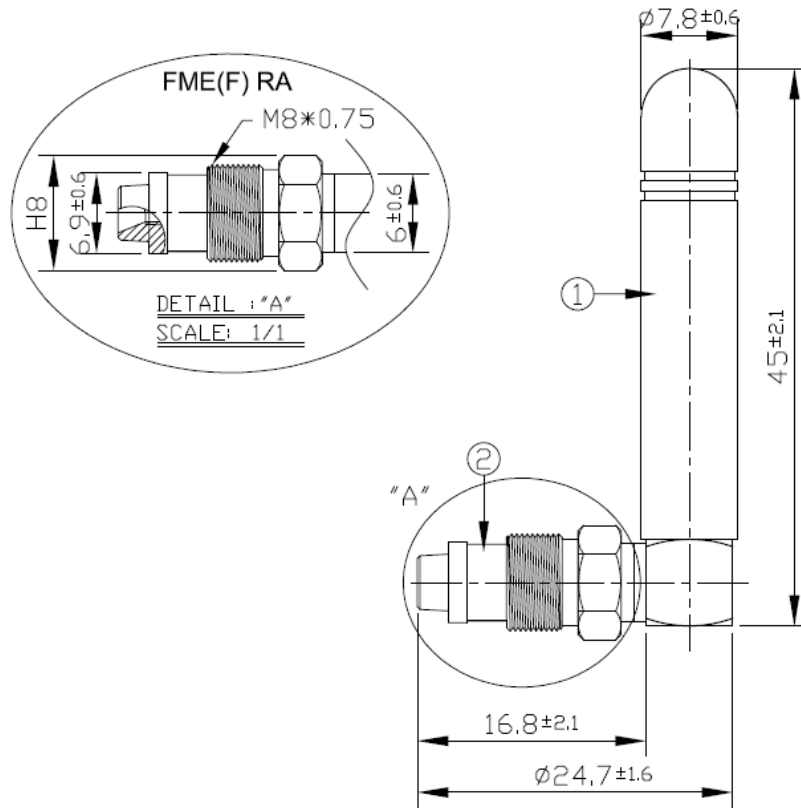

Figure 6. 2D Radiation Pattern of the TG.22 Antenna.

6. Mechanical Drawing



	Name	P/N	Material	Finish	QTY
①	Antenna Housing	000111F030002A	TPEE	Black	1
②	FME(F) RA	202513J000002A	Brass	Ni Plated	1

Figure 7. Mechanical Drawings of the TG.22

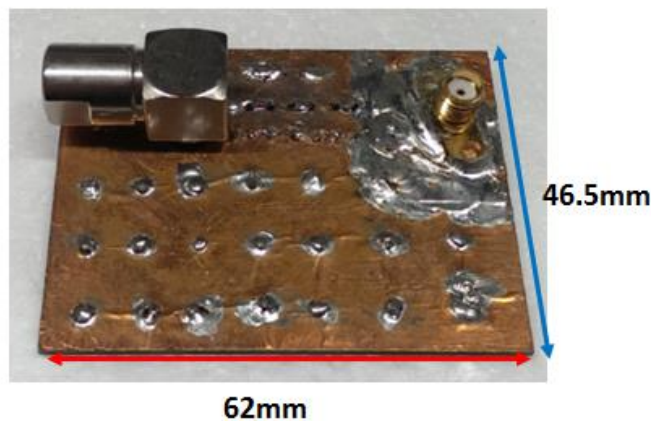

Figure 8. TG.22 Antenna EVB

7. Installation Guide



Recommended Torque for Mounting 0.78N·m

Maximum Torque for Mounting 1.47N·m

8. Packaging

- 1pcs TG.22 antenna per small PE bag (74*42mm)(Weight 0.05kg)
- 100 small PE bags put in one big PE bag. Final package will have 100pcs TG.22 antennas in big PE bag (263*172mm)

