



Chipsmall Limited consists of a professional team with an average of over 10 year of expertise in the distribution of electronic components. Based in Hongkong, we have already established firm and mutual-benefit business relationships with customers from,Europe,America and south Asia,supplying obsolete and hard-to-find components to meet their specific needs.

With the principle of “Quality Parts,Customers Priority,Honest Operation,and Considerate Service”,our business mainly focus on the distribution of electronic components. Line cards we deal with include Microchip,ALPS,ROHM,Xilinx,Pulse,ON,Everlight and Freescale. Main products comprise IC,Modules,Potentiometer,IC Socket,Relay,Connector.Our parts cover such applications as commercial,industrial, and automotives areas.

We are looking forward to setting up business relationship with you and hope to provide you with the best service and solution. Let us make a better world for our industry!



Contact us

Tel: +86-755-8981 8866 Fax: +86-755-8427 6832

Email & Skype: info@chipsmall.com Web: www.chipsmall.com

Address: A1208, Overseas Decoration Building, #122 Zhenhua RD., Futian, Shenzhen, China



SPEC

Spec No.	TQ3C-8EAF0-E1YAJ05-00
Date	January 31, 2013

TYPE : TG035QVLQAANN-GN00
< 3.5 inch QVGA transmissive monochrome TFT
with LED backlight >

CONTENTS

1. Application
2. Construction and outline
3. Mechanical specifications
4. Absolute maximum ratings
5. Electrical characteristics
6. Optical characteristics
7. Interface signals
8. Input timing characteristics
9. Backlight characteristics
10. Lot number identification
11. Warranty
12. Precautions for use
13. Reliability test data
14. Outline drawing

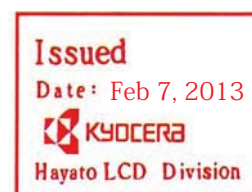

KYOCERA CORPORATION
LCD DIVISION

This specification is subject to change without notice.
Consult Kyocera before ordering.

Original Issue Date	Designed by: Engineering dept.			Confirmed by: QA dept.	
	Prepared	Checked	Approved	Checked	Approved
January 31, 2013	<i>H. Mori</i>	<i>Y. Yamazaki</i>	<i>M. Fujitani</i>	<i>I. Hamada</i>	<i>T. Ito</i>

Spec No. TQ3C-8EAF0-E1YAJ05-00	Part No. TG035QVLQAANN-GN00	Page -
-----------------------------------	--------------------------------	-----------

Warning

1. This Kyocera LCD module has been specifically designed for use only in electronic devices and industrial machines in the area of audio control, office automation, industrial control, home appliances, etc. The module should not be used in applications where the highest level of safety and reliability are required and module failure or malfunction of such module results in physical harm or loss of life, as well as enormous damage or loss. Such fields of applications include, without limitation, medical, aerospace, communications infrastructure, atomic energy control. Kyocera expressly disclaims any and all liability resulting in any way to the use of the module in such applications.

2. Customer agrees to indemnify, defend and hold Kyocera harmless from and against any and all actions, claims, damages, liabilities, awards, costs, and expenses, including legal expenses, resulting from or arising out of Customer's use, or sale for use, or Kyocera modules in applications.

Caution

1. Kyocera shall have the right, which Customer hereby acknowledges, to immediately scrap or destroy tooling for Kyocera modules for which no Purchase Orders have been received from the Customer in a two-year period.

Spec No. TQ3C-8EAF0-E1YAJ05-00	Part No. TG035QVLQAANN-GN00	Page -
-----------------------------------	--------------------------------	-----------

Revision record

Date		Designed by : Engineering dept.			Confirmed by : QA dept.	
		Prepared	Checked	Approved	Checked	Approved
Rev.No.	Date	Page	Descriptions			

1. Application

This document defines the specification of TG035QVLQAANN-GN00. (RoHS Compliant)

2. Construction and outline

LCD	: Transmissive monochrome dot matrix type TFT
Backlight system	: LED
Polarizer	: Glare treatment
Additional circuit	: Timing controller, Power supply (3.3V input) (without constant current circuit for LED Backlight)

3. Mechanical specifications

Item	Specification	Unit
Outline dimensions 1)	76.9(W)×63.9(H)×4.9(D)	mm
Active area	70.56(W)×52.92(H) (8.8cm/3.5 inch(Diagonal))	mm
Dot format	320×3(W)×240(H)	dot
Dot pitch	0.0735(W)×0.2205(H)	mm
Base color 2)	Normally White	-
Mass	40	g

1) Projection not included. Please refer to outline for details.

2) Due to the characteristics of the LCD material, the color varies with environmental temperature.

4. Absolute maximum ratings

4-1. Electrical absolute maximum ratings

Item	Symbol	Min.	Max.	Unit
Supply voltage	V _{DD}	-0.3	4.0	V
Input signal voltage 1)	V _{IN}	-0.3	4.0	V
LED forward current 2) 3)	I _F	-	30	mA

- 1) Input signal : CK, DA0 ~ DA7, DB0 ~ DB7, DC0 ~ DC7, H_{SYNC}, V_{SYNC}, ENAB, REST, CSB, SCK, SDI
- 2) For each "AN-CA"
- 3) Do not apply reversed voltage.

4-2. Environmental absolute maximum ratings

Item	Symbol	Min.	Max.	Unit
Operating temperature 1)	T _{OP}	-20	70	°C
Storage temperature 2)	T _{STO}	-30	80	°C
Operating humidity 3)	H _{OP}	10	4)	%RH
Storage humidity 3)	H _{STO}	10	4)	%RH
Vibration	-	5)	5)	-
Shock	-	6)	6)	-

- 1) Operating temperature means a temperature which operation shall be guaranteed. Since display performance is evaluated at 25°C, another temperature range should be confirmed.
- 2) Temp. = -30°C < 48h , Temp. = 80°C < 168h
Store LCD at normal temperature/humidity. Keep them free from vibration and shock. An LCD that is kept at a low or a high temperature for a long time can be defective due to other conditions, even if the low or high temperature satisfies the standard. (Please refer to "Precautions for Use" for details.)
- 3) Non-condensing
- 4) Temp. ≤ 40°C, 85%RH Max.
Temp. > 40°C, Absolute humidity shall be less than 85%RH at 40°C.
- 5)

Frequency	10 ~ 55 Hz	Acceleration value (0.3 ~ 9 m/s ²)
Vibration width	0.15mm	
Interval	10-55-10 Hz	1 minutes

2 hours in each direction X, Y, Z (6 hours total)

EIAJ ED-2531

- 6) Acceleration: 490 m/s², Pulse width: 11 ms
3 times in each direction: ±X, ±Y, ±Z
EIAJ ED-2531

5. Electrical characteristics

Temp. = -20 ~ 70°C

Item	Symbol	Condition	Min.	Typ.	Max.	Unit
Supply voltage 1)	V _{DD}	-	3.0	3.3	3.6	V
Current consumption	I _{DD}	2)	-	8.0	11.3	mA
Permissible input ripple voltage	V _{RP}	V _{DD} =3.3V	-	-	100	mVp-p
Input signal voltage 3)	V _{IL}	"Low" level	0	-	0.2V _{DD}	V
	V _{IH}	"High" level	0.8V _{DD}	-	V _{DD}	V

1) V_{DD}-turn-on conditions

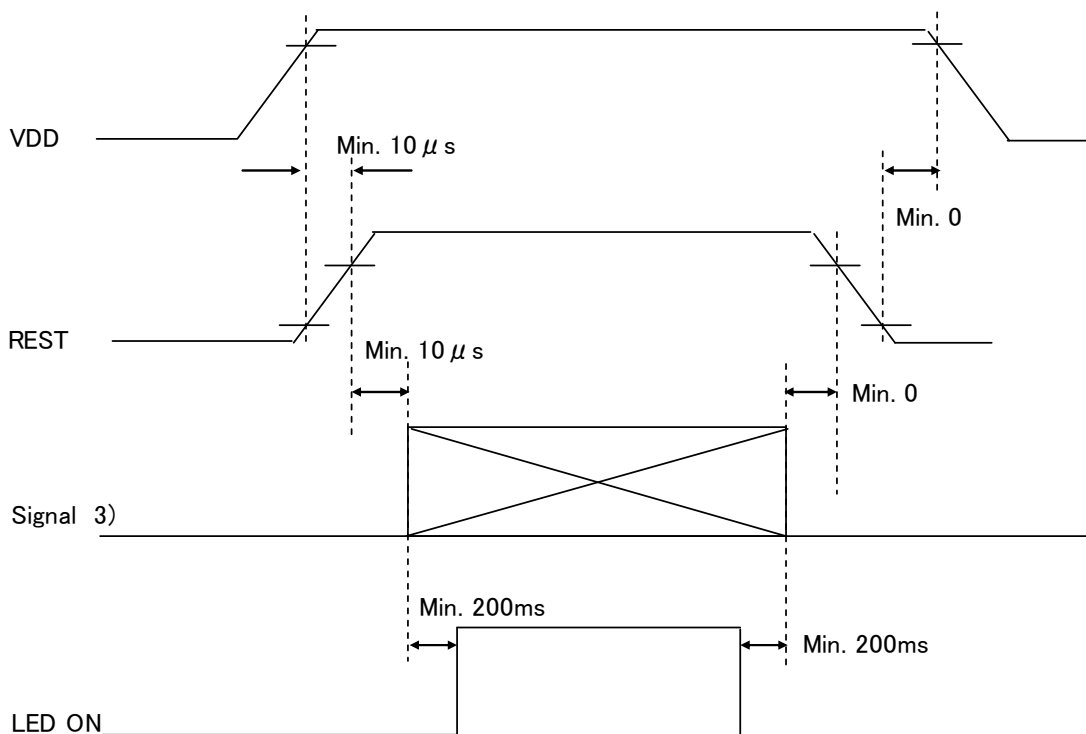

2) I_{DD} measuring conditions

Typ. : V_{DD}=3.3V, Temp. = 25°C

Max. : V_{DD}=3.6V, Temp. = 70°C

Display pattern

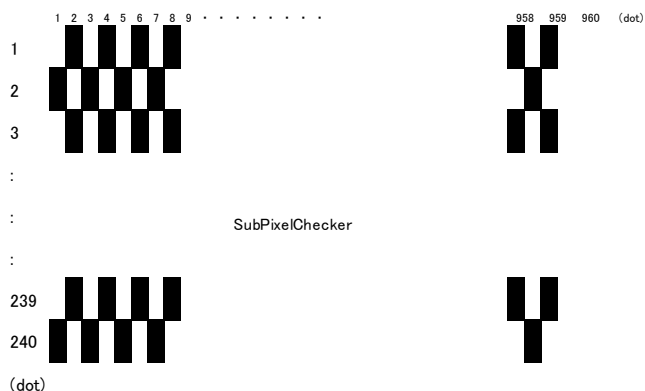

3) Input signal : CK, DA0 ~ DA7, DB0 ~ DB7, DC0 ~ DC7, H_{SYNC}, V_{SYNC}, ENAB, REST, CSB, SCK, SDI

6. Optical characteristics

Measuring spot = φ 6.0mm, Temp. = 25°C

Item	Symbol	Condition	Min.	Typ.	Max.	Unit	
Response time	Rise	$\theta = \varphi = 0^\circ$	-	8	-	ms	
	Down	$\theta = \varphi = 0^\circ$	-	22	-	ms	
Viewing angle range View direction : 12 o'clock (Gray inversion)	θ UPPER	CR ≥ 10	-	80	-	deg.	
	θ LOWER		-	60	-		
	φ LEFT		-	80	-	deg.	
	φ RIGHT		-	80	-		
Contrast ratio	CR	$\theta = \varphi = 0^\circ$	700	1000	-	-	
Brightness	L	IF=15mA/Line	840	1200	-	cd/m ²	
Chromaticity coordinates	White	x	$\theta = \varphi = 0^\circ$	0.260	0.310	0.360	-
		y		0.260	0.310	0.360	

6-1. Definition of contrast ratio

$$\text{CR(Contrast ratio)} = \frac{\text{Brightness with all pixels "White"}}{\text{Brightness with all pixels "Black"}}$$

6-2. Definition of response time

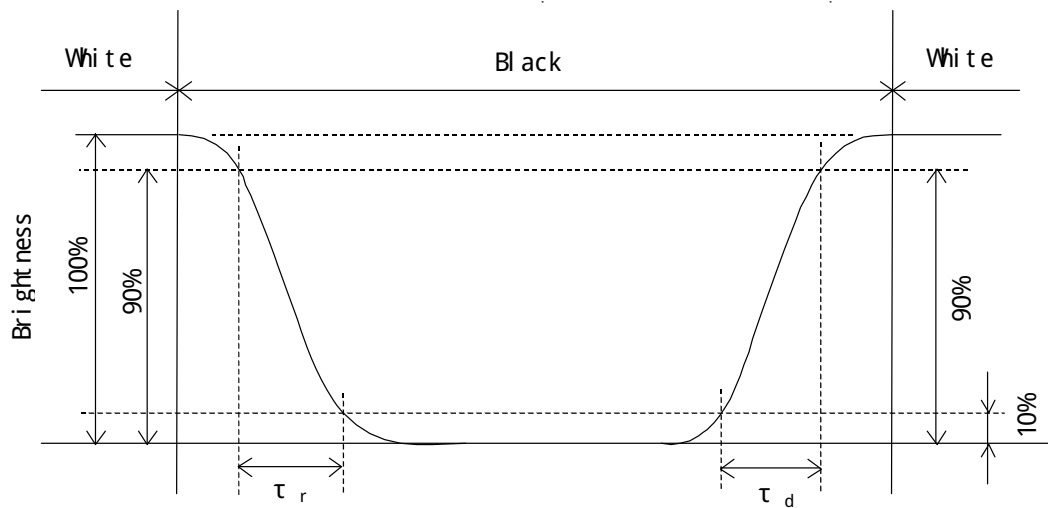

6-3. Definition of viewing angle

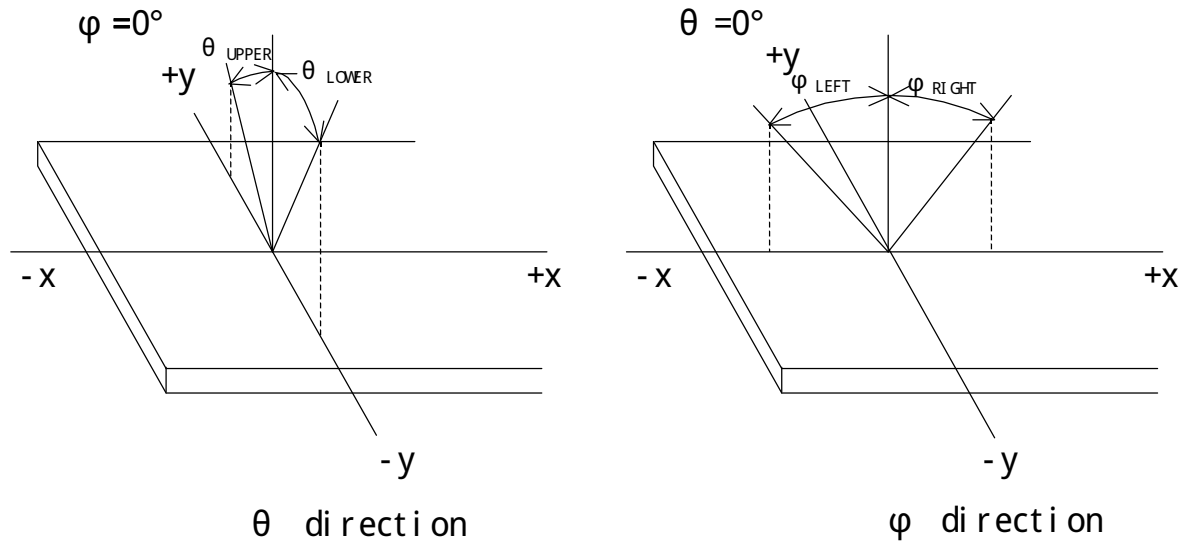

6-4. Brightness measuring points

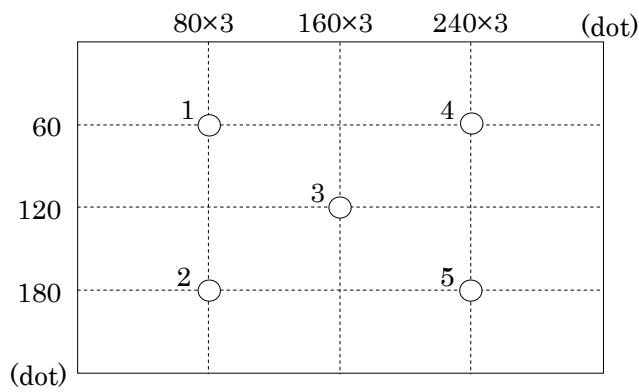

- 1) Rating is defined as the white brightness at center of display screen(3).
- 2) 5 minutes after LED is turned on. (Ambient Temp.=25°C)

7. Interface signals

No.	Symbol	Description	Note
1	GND	GND	
2	GND	GND	
3	V _{DD}	3.3V power supply	
4	V _{DD}	3.3V power supply	
5	DA0	data signal(LSB)	
6	DA1	data signal	
7	DA2	data signal	
8	DA3	data signal	
9	DA4	data signal	
10	DA5	data signal	
11	DA6	data signal	
12	DA7	data signal(MSB)	
13	DB0	data signal(LSB)	
14	DB1	data signal	
15	DB2	data signal	
16	DB3	data signal	
17	DB4	data signal	
18	DB5	data signal	
19	DB6	data signal	
20	DB7	data signal(MSB)	
21	DC0	data signal(LSB)	
22	DC1	data signal	
23	DC2	data signal	
24	DC3	data signal	
25	DC4	data signal	
26	DC5	data signal	
27	DC6	data signal	
28	DC7	data signal(MSB)	
29	GND	GND	
30	CK	Sampling clock	
31	CSB	Select signal(SPI)	
32	H _{SYNC}	Horizontal synchronous signal(negative)	
33	V _{SYNC}	Vertical synchronous signal(negative)	
34	ENAB	Data Enable (Low signal only)	
35	GND	GND	
36	REST	Reset signal	
37	SCK	Clock (SPI)	
38	SDI	Data signal(SPI)	
39	GND	GND	
40	NC	Since it is interior terminal, do not connect signal and make it as OPEN terminal.	
41	NC		
42	NC		
43	NC	NC	
44	GND	GND	
45	CA1	Cathode1	
46	NC	NC	
47	AN1	Anode1	
48	AN2	Anode2	
49	NC	NC	
50	CA2	Cathode2	

8. Input timing characteristics

8-1. LCD

Item		Symbol	Min.	Typ.	Max.	Unit	Note
Clock (CK)	Frequency	1/Tc	-	6.5	-	MHz	
	Period	Tc	-	154	-	ns	
	High time	Tch	50	-	-	ns	
	Low time	Tcl	50	-	-	ns	
Data (DA0~DA7,DB0~DB7,DC0~DC7)	Set up time	Tds	12	-	-	ns	
	Hold time	Tdh	12	-	-	ns	
Horizontal sync. Signal (HSYNC)	Set up time	Ths	20	-	-	ns	
	Hold time	Thh	20	-	-	ns	
	Frequency	1/Th	-	14.9	-	kHz	
	Period	Th	-	408	-	Tc	
	Front porch	Thf	-	20	-	Tc	
	Back porch	Thb	-	68	-	Tc	
Horizontal display period		Thd	320			Tc	
Vertical sync. Signal (VSYNC)	Set up time	Tvs	20	-	-	ns	
	Hold time	Tvh	20	-	-	ns	
	Period	Tv	-	262	-	Th	
	Front porch	Tvf	-	4	-	Th	
	Back porch	Tvb	-	18	-	Th	
Vertical display period		Tvd	240			Th	
Synchronous signal phase lag		Thv	0	-	240	Tc	
Refresh rate		1/Tv	-	60	-	Hz	
Reset signal (REST)	Pulse width	Tres	10	-	-	μs	

1) In case of lower frequency, the deterioration of the display quality, flicker etc., may occur.

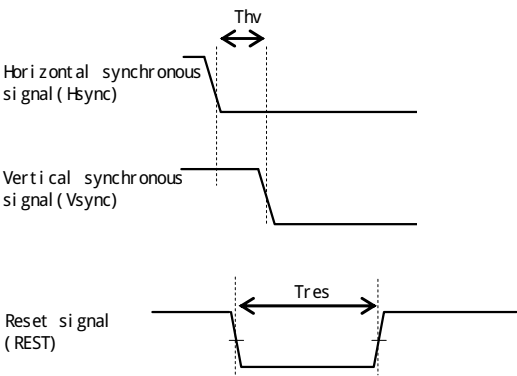
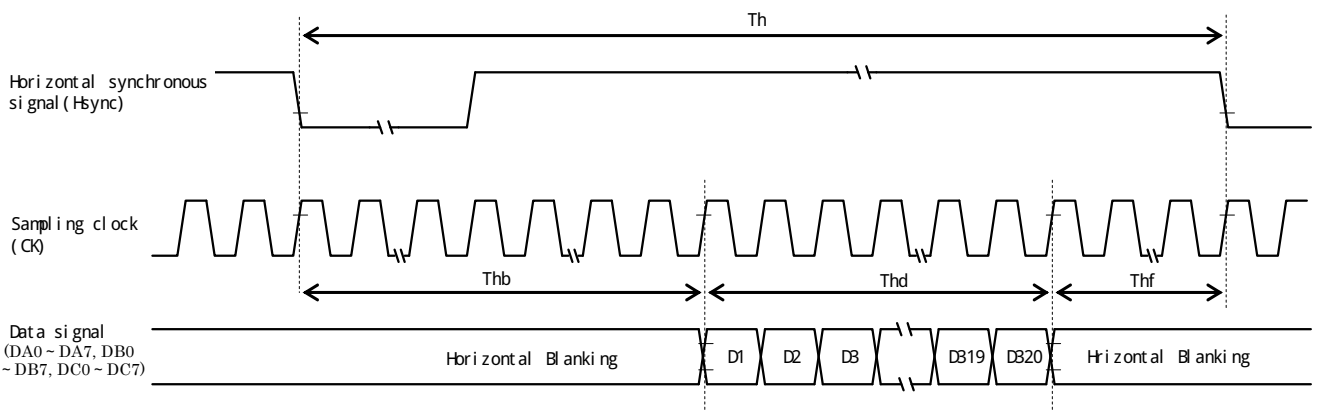
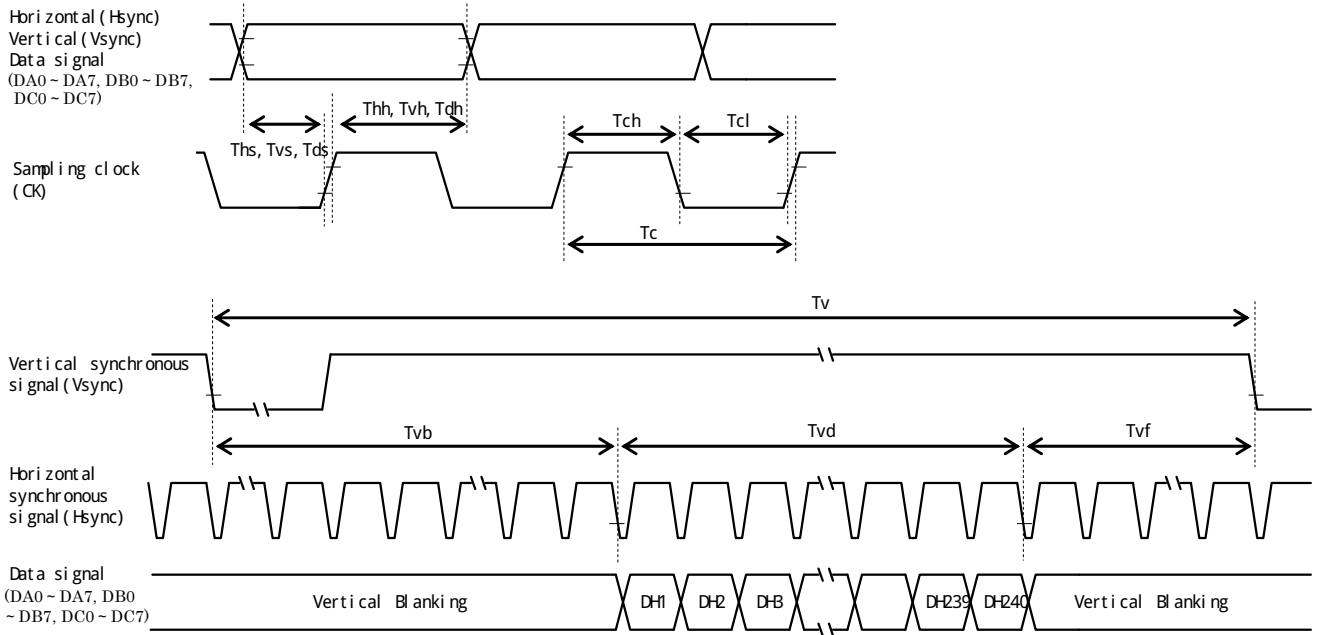

8-2. SPI

	Item	Symbol	Min.	Typ.	Max.	Unit	Note
Clock (SCK)	Period	Tsc	50	-	-	ns	
	High time	Tsch	25	-	-	ns	
	Low time	Tscl	25	-	-	ns	
Select signal (CSB)	Set up time	Tcss	50	-	-	ns	
	Hold time	Tcsh	50	-	-	ns	
	High time	Tcs	50	-	-	ns	
Data signal (SDI)	Set up time	Tds	15	-	-	ns	
	Hold time	Tdh	15	-	-	ns	

First Transmission (Register) Ex.R01h

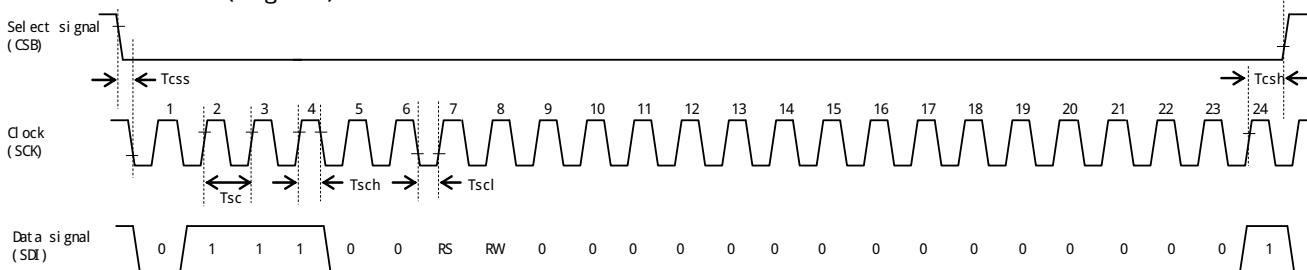

Second Transmission (Data) Ex.7300

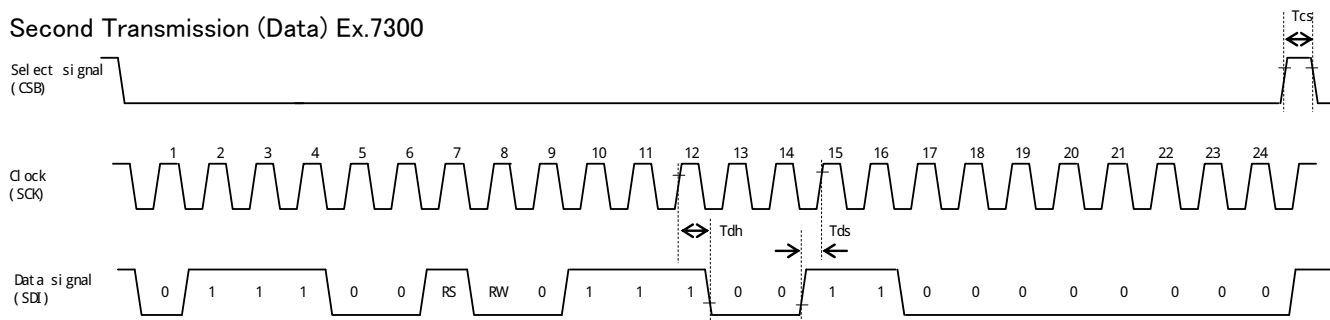

Transmission Format

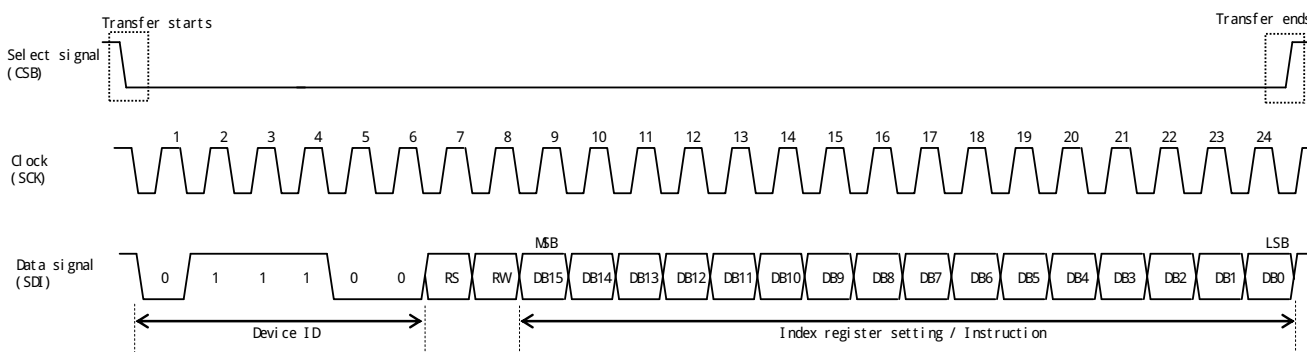

8-3. Register

Reg#	Hex Code	Note
R01h	7300	1)
R02h	0200	
R03h	6464	
R04h	04C7	
R05h	F444	
R06h	E860	
R08h	06FF	
R0Ah	4008	
R0Bh	D400	
R0Dh	422C	
R0Eh	2D00	
R0Fh	0000	
R16h	9F80	
R17h	2212	
R1Eh	006D	
R30h	0001	
R31h	0105	
R32h	0000	
R33h	0102	
R34h	0707	
R35h	0206	
R36h	0607	
R37h	0201	
R3Ah	1400	
R3Bh	1400	

1) Scanning

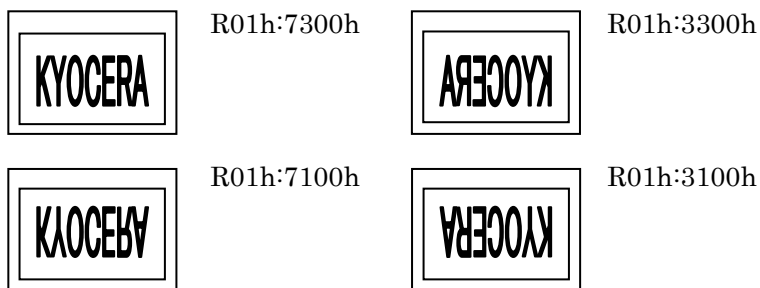

8-4. Input Data Signals and Display position on the screen

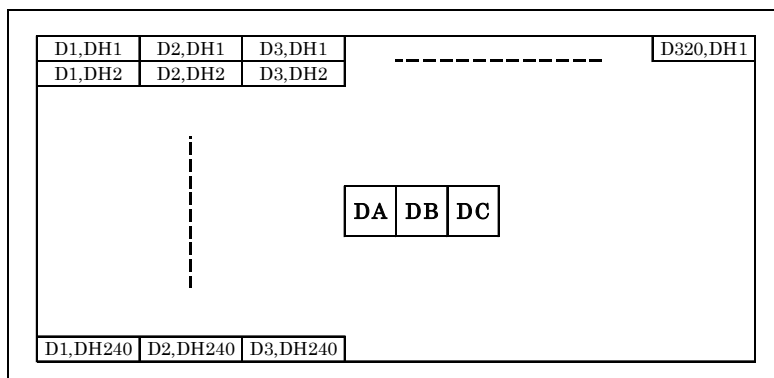

9. Backlight characteristics

Item	Symbol	Min.	Typ.	Max.	Unit	Note
Forward current 1)	IF	-	15	-	mA	Ta=-20 ~ 70°C
Forward voltage 1)	VF	-	13.0	13.8	V	IF=15mA, Ta=-20°C
		-	12.5	13.3	V	IF=15mA, Ta=25°C
		-	12.2	13.0	V	IF=15mA, Ta=70°C
Operating life time 2), 3)	T	-	60,000	-	h	IF=15mA, Ta=25°C

- 1) For each "AN-CA"
- 2) When brightness decrease 50% of minimum brightness.
The average life of a LED will decrease when the LCD is operating at higher temperatures.
- 3) Life time is estimated data.(Condition : IF=15mA, Ta=25°C in chamber).
- 4) An input current below 5mA may reduce the brightness uniformity of the LED backlight.
This is because the amount of light from each LED chip is different. Therefore, please evaluate carefully before finalizing the input current.

10. Lot number identification

The lot number shall be indicated on the back of the backlight case of each LCD.

TG035QVLQAANN-GN00 - □□ - □□ - □ MADE IN □□□□□
 ↓↓ ↓ ↓ ↓ ↓
 1 2 3 4 5

No1. - No5. above indicate
 1. Year code
 2. Month code
 3. Date
 4. Version Number
 5. Country of origin (Japan or China)

Year	2013	2014	2015	2016	2017	2018
Code	3	4	5	6	7	8

Month	Jan.	Feb.	Mar.	Apr.	May	Jun.
Code	1	2	3	4	5	6

Month	Jul.	Aug.	Sep.	Oct.	Nov.	Dec.
Code	7	8	9	X	Y	Z

11. Warranty

11-1. Incoming inspection

Please inspect the LCD within one month after your receipt.

11-2. Production warranty

Kyocera warrants its LCD's for a period of 12 months from the ship date. Kyocera shall, by mutual agreement, replace or re-work defective LCD's that are shown to be Kyocera's responsibility.

Spec No. TQ3C-8EAF0-E1YAJ05-00	Part No. TG035QVLQAANN-GN00	Page 13
-----------------------------------	--------------------------------	------------

12. Precautions for use

12-1. Installation of the LCD

- 1) A transparent protection plate shall be added to protect the LCD and its polarizer.
- 2) The LCD shall be installed so that there is no pressure on the LSI chips.
- 3) The LCD shall be installed flat, without twisting or bending.
- 4) A transparent protection sheet is attached to the polarizer. Please remove the protection film slowly before use, paying attention to static electricity.

12-2. Static electricity

- 1) Since CMOS ICs are mounted directly onto the LCD glass, protection from static electricity is required.
- 2) Workers should use body grounding. Operator should wear ground straps.

12-3. LCD operation

- 1) The LCD shall be operated within the limits specified. Operation at values outside of these limits may shorten life, and/or harm display images.
- 2) Please select the best display pattern based on your evaluation because flicker, lines or nonuniformity or unevenness can be visible depending on display patterns.

12-4. Storage

- 1) The LCD shall be stored within the temperature and humidity limits specified.
Store in a dark area, and protect the LCD from direct sunlight or fluorescent light.
- 2) Always store the LCD so that it is free from external pressure onto it.

12-5. Usage

- 1) **DO NOT** store in a high humidity environment for extended periods. Polarizer degradation bubbles, and/or peeling off of the polarizer may result.
- 2) The front polarizer is easily scratched or damaged. Prevent touching it with any hard material, and from being pushed or rubbed.
- 3) The LCD screen may be cleaned by wiping the screen surface with a soft cloth or cotton pad using a little Ethanol.
- 4) Water may cause damage or discoloration of the polarizer. Clean condensation or moisture from any source immediately.
- 5) Always keep the LCD free from condensation during testing. Condensation may permanently spot or stain the polarizer.
- 6) Do not disassemble LCD because it will result in damage.
- 7) This Kyocera LCD has been specifically designed for use in general electronic devices, but not for use in a special environment such as usage in an active gas. Hence, when the LCD is supposed to be used in a special environment, evaluate the LCD thoroughly beforehand and do not expose the LCD to chemicals such as an active gas.
- 8) Please do not use solid-base image pattern for long hours because a temporary afterimage may appear. We recommend using screen saver etc. in cases where a solid-base image pattern must be used.
- 9) Liquid crystal may leak when the LCD is broken. Be careful not to let the fluid go into your eyes and mouth. In the case the fluid touches your body; rinse it off right away with water and soap.

13. Reliability test data

Test item	Test condition	Test time	Judgement
High temp. atmosphere	80°C	240h	Display function : No defect Display quality : No defect Current consumption : No defect
Low temp. atmosphere	-30°C	240h	Display function : No defect Display quality : No defect Current consumption : No defect
High temp. humidity atmosphere	40°C 90% RH	240h	Display function : No defect Display quality : No defect Current consumption : No defect
Temp. cycle	-30°C 0.5h R.T. 0.5h 80°C 0.5h	10cycles	Display function : No defect Display quality : No defect Current consumption : No defect
High temp. operation	70°C	500h	Display function : No defect Display quality : No defect Current consumption : No defect

- 1) Each test item uses a test LCD only once. The tested LCD is not used in any other tests.
- 2) The LCD is tested in circumstances in which there is no condensation.
- 3) The reliability test is not an out-going inspection.
- 4) The result of the reliability test is for your reference purpose only.
The reliability test is conducted only to examine the LCD's capability.

No	Description	Drawn	Checked	Checked	Approved
△	Title Change. (タイトル変更) Correction of note. (誤記訂正)	'12.07.10 蔭山	'12.07.10 倉元		'12.07.11 朝倉

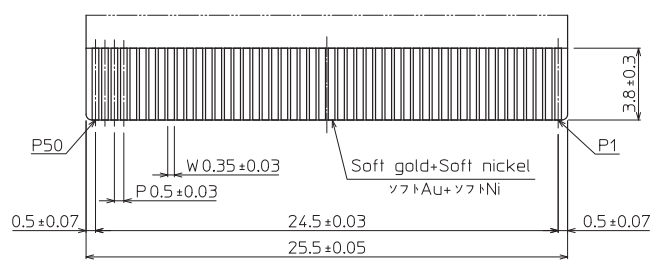

DETAIL C (5:1)

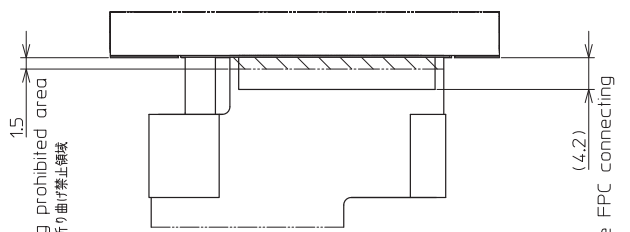

DETAIL B (2:1)

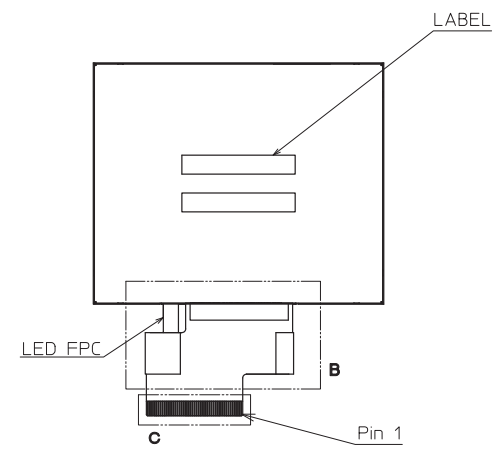
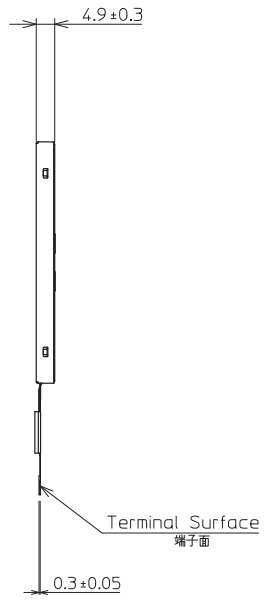
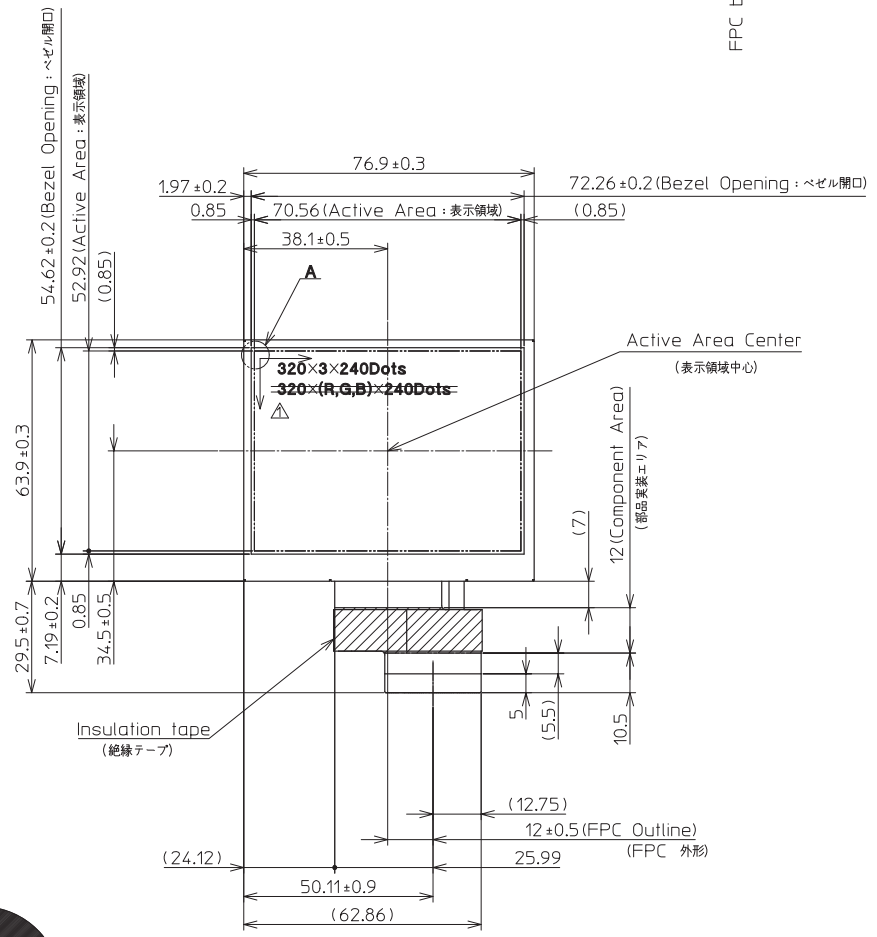

DETAIL A (Dot Size)
(NTS)

Projection part is (1.5)mm thickness.
(厚み (1.5)mm)

Note.(注記)
△:KYOCERA-ELCO
1. Matching Connector (Reference): 04 6240 050 023 846+(KYOCERA Connector Products) etc.
2. The Information of LCD is displayed starting at the upper left hand corner moving right then down to the lower right hand corner.
(LCDにおいて、画像データの表示は左上コーナーから始まり、右へ進み下へ送られ右下コーナーへ向かう。)
3. Tolerance without indication: ±0.5
(指示無き公差)

Material 材質	Treatment 処理	Approved '12.03.16	Checked	Checked '12.03.06	Drawn 蔭山	Scale 1:1(2:1,NTS)	Title △ TG035QVLQAANN TG035QVLPAAANN	KYOCERA	Year-Month-Day '12.03.05	Size 2
Quantity 製作数	Description 備考	朝倉		倉元			Outline Dimensions		Drawing No. 121A8056100-1	

△ ○ FPC引き出し方法(参考例)
Wiring methods FPC(Reference Example)

△ × FPC引き出し方法(NG)
Wiring methods FPC(cases NG)

△ × FPC引き出し方法(NG)
Wiring methods FPC(cases NG)

下図のような、セット側基板などをままだ引き出しは、
実装エリアに応力がかかり、部品の損傷が発生する恐れがあります。
As shown below, wiring across the board and set
implementation takes the stress area, may cause
damage to components.

FPCを表示面側に折り曲げての取り付けは、
FPCの断線が発生する恐れがあります。
Installing the folded side to view the FPC is
May cause breakage of the FPC.

FPC引き出し部は、1Minのクリアランスを確保してください
FPC drawer unit, please provided a clearance of 1Min

セット側コネクタ(The set of connectors)
セット側基板(The board set)

実装部品がセット基板などと接触しないよう引き回しをしてください
Please do not contact with the routing
of printed circuit boards and components

部品実装エリア12(FPC自身の反発力で変形しない引き回しをしてください)
Mounting area 12(please do not deform in the
resilience of its routing FPC)

セット側基板(The board set)
セット側コネクタ
(The set of connectors)

セット側コネクタ
(The set of connectors)

No	Description	Drawn	Checked	Checked	Approved
△	Added reference value. (参考値追加)	'11.02.28 蔭山	'11.02.28 朝倉		'11.02.28 朝倉
△	Added wiring methods FPC (Reference Example) (FPC引き出し方法(参考例追加))	'11.06.17 蔭山	'11.07.04 倉元		'11.07.04 朝倉

参考(for Reference)

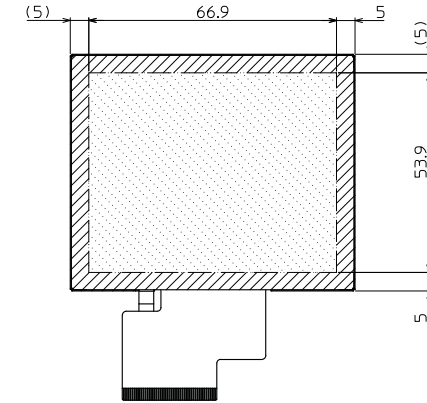
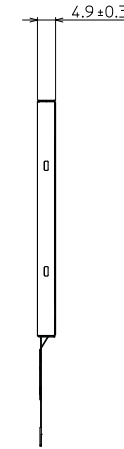
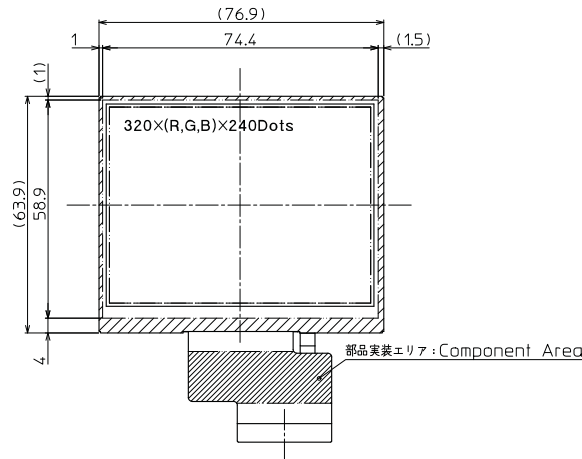

※取り付け例 (Installation guidance)

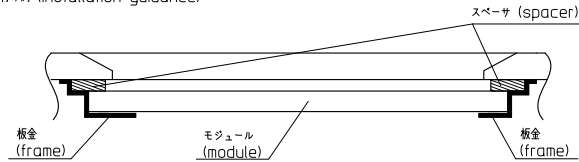

(NTS)

△ ※裏面の押さえつけ可能領域以外 (押さえつけ禁止エリアを除く) を押さえると、取付構造によっては、
表示ムラが発生する場合があります。
しかしながら、GND接続等で押さえる必要が有る場合は、25mm2 (5mmX5mm)に対して、
0.33kgf (3.2N)を目安として下さい。
なお、上記値は、参考数値であり、実際の取付構造により十分評価頂きますようお願いいたします。

(※ If area other than pressure available area on the rear side is pressured,
there is a case that display variation is caused.
However, when pressure is needed for GND connection or so,
0.33kgf (3.2N) per 25mm2 (5mmX5mm) will be a referential figure.
Above figure is reference only. Therefore, please evaluate well under
the actual installation structure.)

取り付け方法
(Installation of the LCD)

ケースにモジュールをはめ込み(X,Y固定)、裏面からZ方向を固定する事が可能。
(The LCD module shall be held in the X/Y direction
by the housing, and in the Z direction using
a backboard.)

斜線部の領域にて、下記の条件を満たし押さえることが望ましい。
(To hold the LCD module in place, it shall be supported
with pressure applied to the hatched areas indicated by
the descriptions below.)

△ 押さえつけ可能領域
(Pressure may be applied in this area.)

押さえつけ可能領域面積 (裏面) : 1308.0mm²
(Pressure may be applied in this area (Back side) : 1308.0mm²)
参考全体荷重 : 4.4kgf (43.6N)
(Referential total load : 4.4kgf (43.6N))
参考平均圧力 : 3.4gf/mm² (33.7kPa)
(Referential average pressure : 3.4gf/mm² (33.7kPa))
※上記値は参考数値であり、実際の取付構造により十分評価頂きますようお願いいたします。
(Above figure is reference only. Therefore, please evaluate well
by the actual installation structure.)

押さえつけ不可領域
(Pressure failure area.)

表面取り付け条件
(Installation conditions (Front side))

1.広い範囲で均一に押さえることが望ましい
(1. The LCD shall be uniformly supported over
as wide an area as possible.)

裏面取り付け条件
(Installation conditions (Back side))

1.FPC部品実装エリアへの接触無きこと
(1. Do not allow any foreign material to contact
the FPC Component Area.)
2.モジュールがたわむこと無きよう押さえつけのこと
(2. Do not allow the LCD module to bend or twist.)
3.広い範囲で均一に押さえることが望ましい
(3. Support the LCD with uniform pressure over as wide
an area as possible.)

注記 (Note)
指定公差 (Tolerance without indication) : ±0.5

Material 材質	Treatment 処理	Approved '10.11.30	Checked	Checked '10.11.30	Drawn	Scale 1:1(NTS)	Title 3.5inch QVGA		Year-Month-Day '10.11.29	Size 2
Quantity 製作数	Description: 備考	RoHS	朝倉	朝倉	蔭山		Module Installation		Drawing No.	10282-03224-2

Spec No.	TQ3C-8EAF0-E2YAJ05-00
Date	January 31, 2013

KYOCERA INSPECTION STANDARD

TYPE : TG035QVLQAANN-GN00

KYOCERA CORPORATION
LCD DIVISION

Original Issue Date	Designed by : Engineering dept.			Confirmed by : QA dept.	
	Prepared	Checked	Approved	Checked	Approved
January 31, 2013	<i>K. Mori</i>	<i>Y. Yamazaki</i>	<i>M. Fujitani</i>	<i>I. Hamada</i>	<i>H. Itoh</i>

Spec No.
TQ3C-8EAF0-E2YAJ05-00

Part No.
TG035QVLQAANN-GN00

Page
-

Revision record

Date		Designed by : Engineering dept.			Confirmed by : QA dept.	
		Prepared	Checked	Approved	Checked	Approved
Rev.No.	Date	Page	Descriptions			

Visuals specification

1) Note

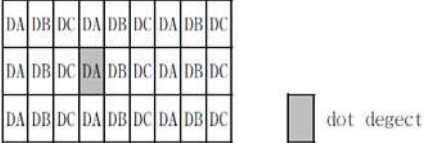
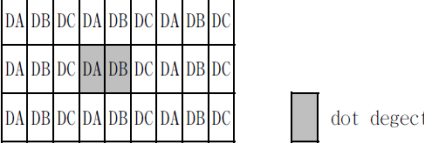
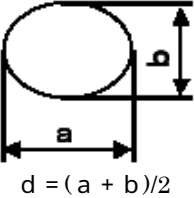
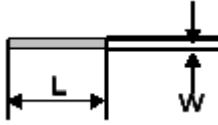
		Note
General		<p>1. Customer identified anomalies not defined within this inspection standard shall be reviewed by Kyocera, and an additional standard shall be determined by mutual consent.</p> <p>2. This inspection standard about the image quality shall be applied to any defect within the active area and shall not be applicable to outside of the area.</p> <p>3. Inspection conditions</p> <p>Luminance : 500 Lux min.</p> <p>Inspection distance : 300 mm.</p> <p>Temperature : 25 ± 5°C</p> <p>Direction : Directly above</p>
Definition of inspection item	Dot defect	<p>Bright dot defect</p> <p>The dot is constantly “on” when power applied to the LCD, even when all “Black” data sent to the screen. Inspection tool: 5% Transparency neutral density filter. Count dot: If the dot is visible through the filter. Don't count dot: If the dot is not visible through the filter.</p> 
		<p>Black dot defect</p> <p>The dot is constantly “off” when power applied to the LCD, even when all “White” data sent to the screen.</p>
		<p>Adjacent dot</p> <p>Adjacent dot defect is defined as two or more bright dot defects or black dot defects.</p> 
	External inspection	<p>Bubble, Scratch, Foreign particle (Polarizer, Cell, Backlight)</p> <p>Visible operating (all pixels “Black” or “White”) and non operating.</p>
	Appearance inspection	<p>Does not satisfy the value at the spec.</p>
Definition of size	<p>Definition of circle size</p>  <p>Definition of linear size</p> 	

2) Standard

Classification		Inspection item	Judgement standard																
Defect (in LCD glass)	Dot defect	Bright dot defect	Acceptable number : 4 Bright dot spacing : 5 mm or more																
		Black dot defect	Acceptable number : 5 Black dot spacing : 5 mm or more																
		2 dot join	Bright dot defect	Acceptable number : 2															
			Black dot defect	Acceptable number : 3															
		3 or more dots join	Acceptable number : 0																
		Total dot defects	Acceptable number : 5 Max																
	Others	White dot, Dark dot (Circle)	<table border="1"> <thead> <tr> <th>Size (mm)</th> <th>Acceptable number</th> </tr> </thead> <tbody> <tr> <td>$d \leq 0.2$</td> <td>(Neglected)</td> </tr> <tr> <td>$0.2 < d \leq 0.4$</td> <td>5</td> </tr> <tr> <td>$0.4 < d \leq 0.5$</td> <td>3</td> </tr> <tr> <td>$0.5 < d$</td> <td>0</td> </tr> </tbody> </table>			Size (mm)	Acceptable number	$d \leq 0.2$	(Neglected)	$0.2 < d \leq 0.4$	5	$0.4 < d \leq 0.5$	3	$0.5 < d$	0				
Size (mm)	Acceptable number																		
$d \leq 0.2$	(Neglected)																		
$0.2 < d \leq 0.4$	5																		
$0.4 < d \leq 0.5$	3																		
$0.5 < d$	0																		
External inspection (Defect on Polarizer or between Polarizer and LCD glass)	Polarizer (Scratch)	<table border="1"> <thead> <tr> <th>Width (mm)</th> <th>Length (mm)</th> <th>Acceptable number</th> </tr> </thead> <tbody> <tr> <td>$W \leq 0.1$</td> <td>-</td> <td>(Neglected)</td> </tr> <tr> <td rowspan="2">$0.1 < W \leq 0.3$</td> <td>$L \leq 5.0$</td> <td>(Neglected)</td> </tr> <tr> <td>$5.0 < L$</td> <td>0</td> </tr> <tr> <td>$0.3 < W$</td> <td>-</td> <td>0</td> </tr> </tbody> </table>			Width (mm)	Length (mm)	Acceptable number	$W \leq 0.1$	-	(Neglected)	$0.1 < W \leq 0.3$	$L \leq 5.0$	(Neglected)	$5.0 < L$	0	$0.3 < W$	-	0	
		Width (mm)	Length (mm)	Acceptable number															
		$W \leq 0.1$	-	(Neglected)															
		$0.1 < W \leq 0.3$	$L \leq 5.0$	(Neglected)															
	$5.0 < L$		0																
	$0.3 < W$	-	0																
	Polarizer (Bubble)	<table border="1"> <thead> <tr> <th>Size (mm)</th> <th>Acceptable number</th> </tr> </thead> <tbody> <tr> <td>$d \leq 0.2$</td> <td>(Neglected)</td> </tr> <tr> <td>$0.2 < d \leq 0.3$</td> <td>5</td> </tr> <tr> <td>$0.3 < d \leq 0.5$</td> <td>3</td> </tr> <tr> <td>$0.5 < d$</td> <td>0</td> </tr> </tbody> </table>			Size (mm)	Acceptable number	$d \leq 0.2$	(Neglected)	$0.2 < d \leq 0.3$	5	$0.3 < d \leq 0.5$	3	$0.5 < d$	0					
		Size (mm)	Acceptable number																
		$d \leq 0.2$	(Neglected)																
		$0.2 < d \leq 0.3$	5																
$0.3 < d \leq 0.5$	3																		
$0.5 < d$	0																		
Foreign particle (Circular shape)	<table border="1"> <thead> <tr> <th>Size (mm)</th> <th>Acceptable number</th> </tr> </thead> <tbody> <tr> <td>$d \leq 0.2$</td> <td>(Neglected)</td> </tr> <tr> <td>$0.2 < d \leq 0.4$</td> <td>5</td> </tr> <tr> <td>$0.4 < d \leq 0.5$</td> <td>3</td> </tr> <tr> <td>$0.5 < d$</td> <td>0</td> </tr> </tbody> </table>			Size (mm)	Acceptable number	$d \leq 0.2$	(Neglected)	$0.2 < d \leq 0.4$	5	$0.4 < d \leq 0.5$	3	$0.5 < d$	0						
	Size (mm)	Acceptable number																	
	$d \leq 0.2$	(Neglected)																	
	$0.2 < d \leq 0.4$	5																	
$0.4 < d \leq 0.5$	3																		
$0.5 < d$	0																		
Foreign particle (Linear shape) Scratch	<table border="1"> <thead> <tr> <th>Width (mm)</th> <th>Length (mm)</th> <th>Acceptable number</th> </tr> </thead> <tbody> <tr> <td>$W \leq 0.03$</td> <td>-</td> <td>(Neglected)</td> </tr> <tr> <td rowspan="3">$0.03 < W \leq 0.1$</td> <td>$L \leq 2.0$</td> <td>(Neglected)</td> </tr> <tr> <td>$2.0 < L \leq 4.0$</td> <td>3</td> </tr> <tr> <td>$4.0 < L$</td> <td>0</td> </tr> <tr> <td>$0.1 < W$</td> <td>-</td> <td>(According to circular shape)</td> </tr> </tbody> </table>			Width (mm)	Length (mm)	Acceptable number	$W \leq 0.03$	-	(Neglected)	$0.03 < W \leq 0.1$	$L \leq 2.0$	(Neglected)	$2.0 < L \leq 4.0$	3	$4.0 < L$	0	$0.1 < W$	-	(According to circular shape)
	Width (mm)	Length (mm)	Acceptable number																
	$W \leq 0.03$	-	(Neglected)																
	$0.03 < W \leq 0.1$	$L \leq 2.0$	(Neglected)																
		$2.0 < L \leq 4.0$	3																
$4.0 < L$		0																	
$0.1 < W$	-	(According to circular shape)																	