



Chipsmall Limited consists of a professional team with an average of over 10 year of expertise in the distribution of electronic components. Based in Hongkong, we have already established firm and mutual-benefit business relationships with customers from,Europe,America and south Asia,supplying obsolete and hard-to-find components to meet their specific needs.

With the principle of “Quality Parts,Customers Priority,Honest Operation,and Considerate Service”,our business mainly focus on the distribution of electronic components. Line cards we deal with include Microchip,ALPS,ROHM,Xilinx,Pulse,ON,Everlight and Freescale. Main products comprise IC,Modules,Potentiometer,IC Socket,Relay,Connector.Our parts cover such applications as commercial,industrial, and automotives areas.

We are looking forward to setting up business relationship with you and hope to provide you with the best service and solution. Let us make a better world for our industry!



Contact us

Tel: +86-755-8981 8866 Fax: +86-755-8427 6832

Email & Skype: info@chipsmall.com Web: www.chipsmall.com

Address: A1208, Overseas Decoration Building, #122 Zhenhua RD., Futian, Shenzhen, China



Features

- Fully integrated PLL-stabilized VCO
- Frequency range from 850 MHz to 930 MHz
- Single-ended RF output
- FSK through crystal pulling allows modulation from DC to 40 kbit/s
- High FSK deviation possible for wideband data transmission
- ASK achieved by on/off keying of internal power amplifier up to 40 kbit/s
- Wide power supply range from 1.95 V to 5.5 V
- Very low standby current
- On-chip low voltage detector
- High over-all frequency accuracy
- FSK deviation and center frequency independently adjustable
- Adjustable output power range from -11 dBm to +9.5 dBm
- Adjustable current consumption from 5.1 mA to 13.4 mA
- Conforms to EN 300 220 and similar standards
- 10-pin quad flat no lead (QFN) package

Ordering Code

Product Code	Temperature Code	Package Code	Option Code	Packing Form Code
TH72035	K	LD	BAA-000	TU
TH72035	K	LD	BAA-000	RE

Legend:

Temperature Code: K for Temperature Range -40°C to 125°C
 Package Code: LD for QFN double
 Packing Form: RE for Reel, TU for Tube

Ordering example: TH72035KLD-BAA-000-TU

Application Examples

- Tire Pressure Monitoring System (TPMS)
- Remote Keyless Entry (RKE)
- Automatic Meter Reading (AMR)
- Alarm and security systems
- Garage door openers
- Home and building automation
- Low-power telemetry
- Wireless access control

Pin Description

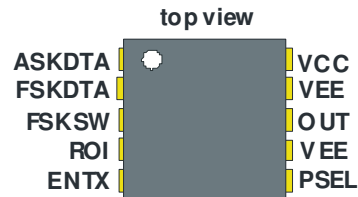

General Description

The TH72035 FSK/ASK transmitter IC is designed for applications in the European 868 MHz industrial-scientific-medical (ISM) band, according to the EN 300 220 telecommunications standard. It can also be used for any other system with carrier frequencies ranging from 850 MHz to 930 MHz (e.g. for applications in the US 902 to 928 MHz ISM band).

The transmitter's carrier frequency f_c is determined by the frequency of the reference crystal f_{ref} . The integrated PLL synthesizer ensures that each RF value, ranging from 850 MHz to 930 MHz, can be achieved. This is done by using a crystal with a reference frequency according to: $f_{ref} = f_c/N$, where $N = 32$ is the PLL feedback divider ratio.

Document Content

1	Theory of Operation	3
1.1	General	3
1.2	Block Diagram.....	3
2	Functional Description	3
2.1	Crystal Oscillator.....	3
2.2	FSK Modulation	4
2.3	Crystal Pulling.....	4
2.4	ASK Modulation	5
2.5	Output Power Selection.....	5
2.6	Lock Detection	5
2.7	Low Voltage Detection	5
2.8	Mode Control Logic.....	6
2.9	Timing Diagrams.....	6
3	Pin Definition and Description	7
4	Electrical Characteristics	8
4.1	Absolute Maximum Ratings.....	8
4.2	Normal Operating Conditions	8
4.3	Crystal Parameters	8
4.4	DC Characteristics	9
4.5	AC Characteristics	10
4.6	Output Power Steps.....	10
5	Typical Operating Characteristics	11
5.1	DC Characteristics	11
5.2	AC Characteristics	14
6	Test Circuit	17
6.1	Test circuit component list to Fig. 18	17
7	Package Description	18
7.1	Soldering Information	18
7.2	Recommended PCB Footprints.....	18
8	Standard information regarding manufacturability of Melexis products with different soldering processes	19
9	ESD Precautions	19
10	Disclaimer	20

1 Theory of Operation

1.1 General

As depicted in Fig.1, the TH72035 transmitter consists of a fully integrated voltage-controlled oscillator (VCO), a divide-by-32 divider (div32), a phase-frequency detector (PFD) and a charge pump (CP). An internal loop filter determines the dynamic behavior of the PLL and suppresses reference spurious signals. A Colpitts crystal oscillator (XOSC) is used as the reference oscillator of a phase-locked loop (PLL) synthesizer. The VCO's output signal feeds the power amplifier (PA). The RF signal power P_{out} can be adjusted in four steps from $P_{out} = -11$ dBm to +9.5 dBm, either by changing the value of resistor RPS or by varying the voltage V_{PS} at pin PSEL. The open-collector output (OUT) can be used either to directly drive a loop antenna or to be matched to a 50Ohm load. Bandgap biasing ensures stable operation of the IC at a power supply range of 1.95 V to 5.5 V.

1.2 Block Diagram

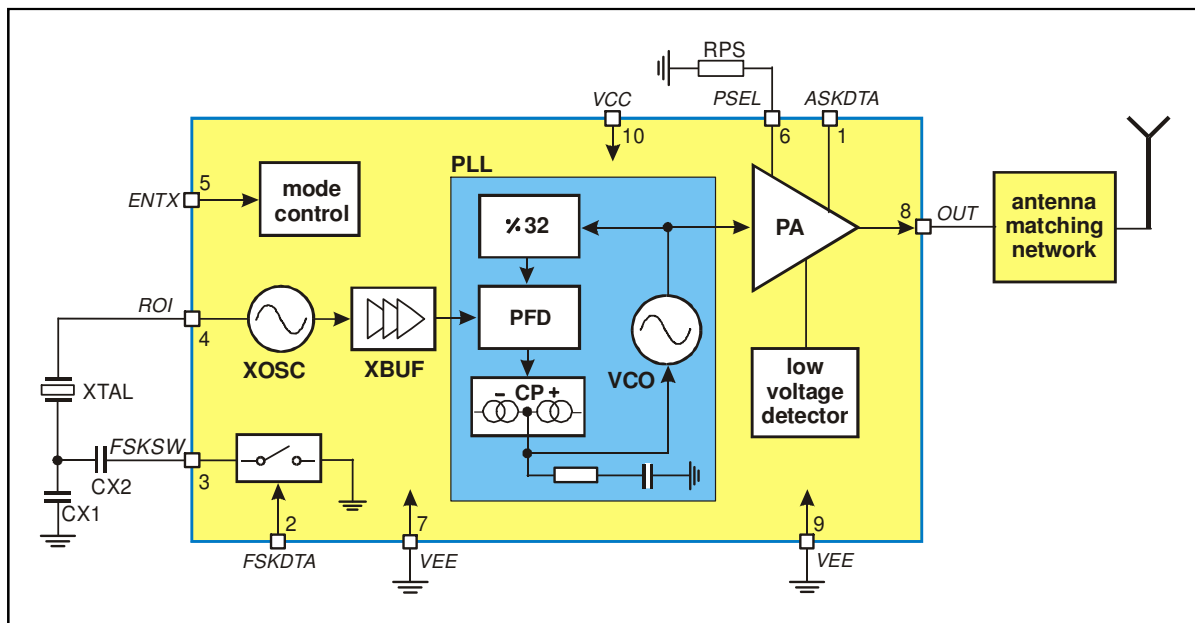

Fig. 1: Block diagram with external components

2 Functional Description

2.1 Crystal Oscillator

A Colpitts crystal oscillator with integrated functional capacitors is used as the reference oscillator for the PLL synthesizer. The equivalent input capacitance CRO offered by the crystal oscillator input pin ROI is about 18pF. The crystal oscillator is provided with an amplitude control loop in order to have a very stable frequency over the specified supply voltage and temperature range in combination with a short start-up time.

2.2 FSK Modulation

FSK modulation can be achieved by pulling the crystal oscillator frequency. A CMOS-compatible data stream applied at the pin FSKDTA digitally modulates the XOSC via an integrated NMOS switch. Two external pulling capacitors CX1 and CX2 allow the FSK deviation Δf and the center frequency f_c to be adjusted independently. At FSKDTA = 0, CX2 is connected in parallel to CX1 leading to the low-frequency component of the FSK spectrum (f_{min}); while at FSKDTA = 1, CX2 is deactivated and the XOSC is set to its high frequency f_{max} . An external reference signal can be directly AC-coupled to the reference oscillator input pin ROI. Then the transmitter is used without a crystal. Now the reference signal sets the carrier frequency and may also contain the FSK (or FM) modulation.

Fig. 2: Crystal pulling circuitry

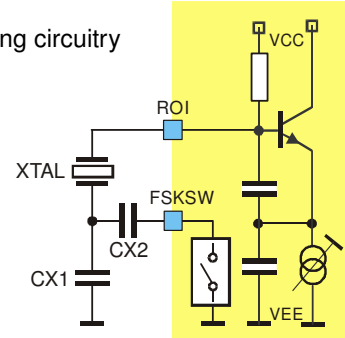

FSKDTA	Description
0	$f_{min} = f_c - \Delta f$ (FSK switch is closed)
1	$f_{max} = f_c + \Delta f$ (FSK switch is open)

2.3 Crystal Pulling

A crystal is tuned by the manufacturer to the required oscillation frequency f_0 at a given load capacitance CL and within the specified calibration tolerance. The only way to pull the oscillation frequency is to vary the effective load capacitance CL_{eff} seen by the crystal. Figure 3 shows the oscillation frequency of a crystal as a function of the effective load capacitance. This capacitance changes in accordance with the logic level of FSKDTA around the specified load capacitance. The figure illustrates the relationship between the external pulling capacitors and the frequency deviation. It can also be seen that the pulling sensitivity increases with the reduction of CL . Therefore, applications with a high frequency deviation require a low load capacitance. For narrow band FSK applications, a higher load capacitance could be chosen in order to reduce the frequency drift caused by the tolerances of the chip and the external pulling capacitors.

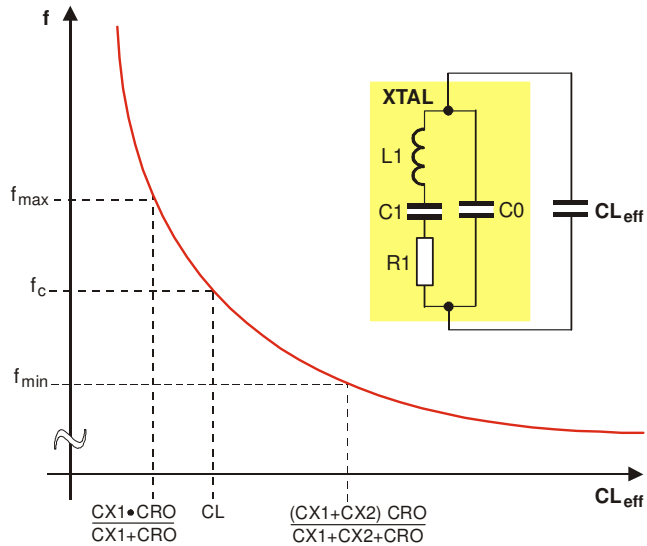

Fig. 3: Crystal pulling characteristic

For ASK applications CX2 can be omitted. Then CX1 has to be adjusted for center frequency.

2.4 ASK Modulation

The PLL transmitter can be ASK-modulated by applying a data stream directly at the pin ASKDTA. This turns the internal current sources of the power amplifier on and off and therefore leads to an ASK signal at the output.

ASKDTA	Description
0	Power amplifier is turned off
1	Power amplifier is turned on (according to the selected output power step)

2.5 Output Power Selection

The transmitter is provided with an output power selection feature. There are four predefined output power steps and one off-step accessible via the power selection pin PSEL. A digital power step adjustment was chosen because of its high accuracy and stability. The number of steps and the step sizes as well as the corresponding power levels are selected to cover a wide spectrum of different applications.

The implementation of the output power control logic is shown in figure 4. There are two matched current sources with an amount of about 8 μ A. One current source is directly applied to the PSEL pin. The other current source is used for the generation of reference voltages with a resistor ladder. These reference voltages are defining the thresholds between the power steps. The four comparators deliver thermometer-coded control signals depending on the voltage level at the pin PSEL. In order to have a certain amount of ripple tolerance in a noisy environment the comparators are provided with a little hysteresis of about 20 mV. With these control signals, weighted current sources of the power amplifier are switched on or off to set the desired output power level (Digitally Controlled Current Source). The LOCK, ASK signal and the output of the low voltage detector are gating this current source.

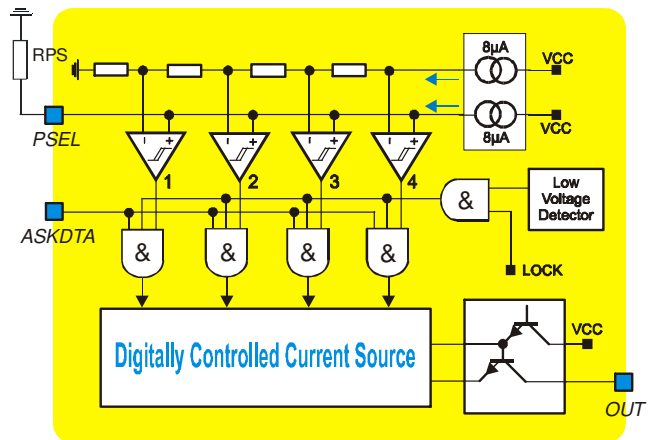

Fig. 4: Block diagram of output power control circuitry

There are two ways to select the desired output power step. First by applying a DC voltage at the pin PSEL, then this voltage directly selects the desired output power step. This kind of power selection can be used if the transmission power must be changed during operation. For a fixed-power application a resistor can be used which is connected from the PSEL pin to ground. The voltage drop across this resistor selects the desired output power level. For fixed-power applications at the highest power step this resistor can be omitted. The pin PSEL is in a high impedance state during the "TX standby" mode.

2.6 Lock Detection

The lock detection circuitry turns on the power amplifier only after PLL lock. This prevents from unwanted emission of the transmitter if the PLL is unlocked.

2.7 Low Voltage Detection

The supply voltage is sensed by a low voltage detect circuitry. The power amplifier is turned off if the supply voltage drops below a value of about 1.85 V. This is done in order to prevent unwanted emission of the transmitter if the supply voltage is too low.

2.8 Mode Control Logic

The mode control logic allows two different modes of operation as listed in the following table. The mode control pin ENTX is pulled-down internally. This guarantees that the whole circuit is shut down if this pin is left floating.

ENTX	Mode	Description
0	TX standby	TX disabled
1	TX active	TX enable

2.9 Timing Diagrams

After enabling the transmitter by the ENTX signal, the power amplifier remains inactive for the time t_{on} , the transmitter start-up time. The crystal oscillator starts oscillation and the PLL locks to the desired output frequency within the time duration t_{on} . After successful PLL lock, the LOCK signal turns on the power amplifier, and then the RF carrier can be FSK or ASK modulated.

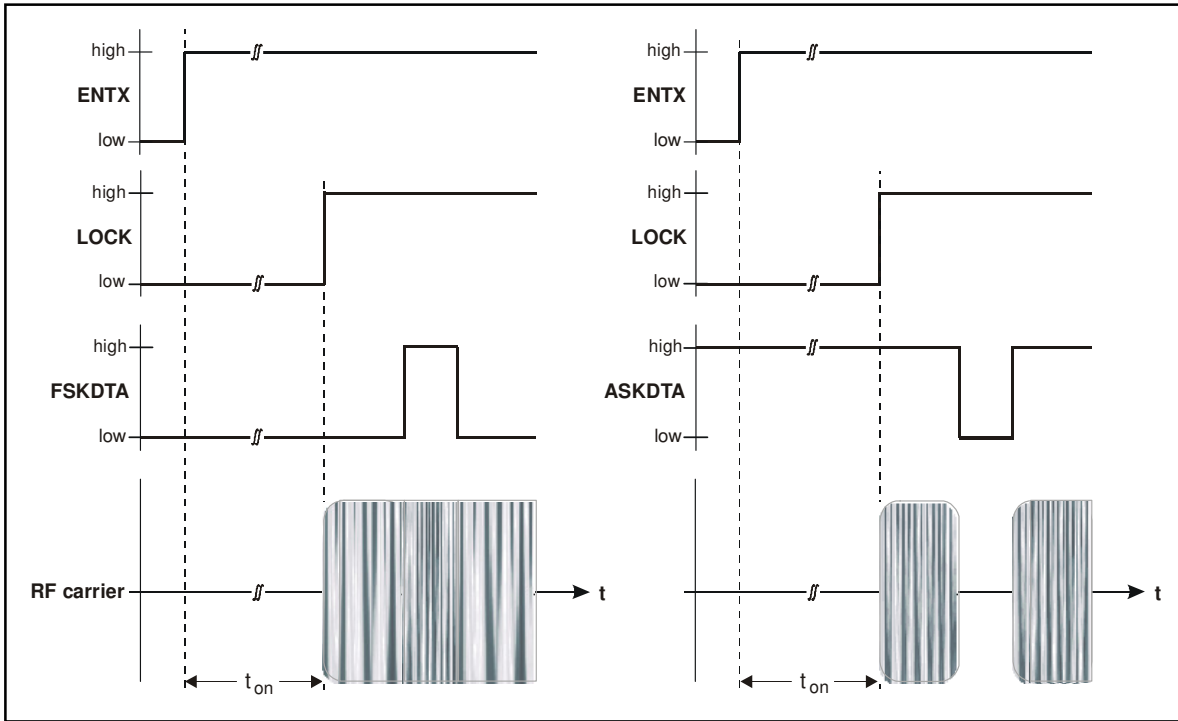
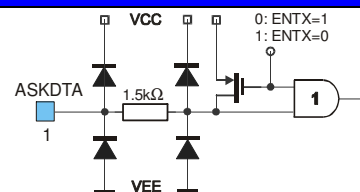
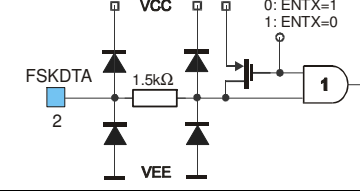
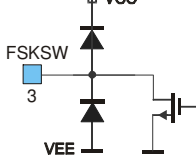
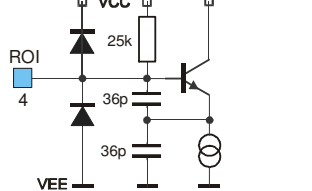
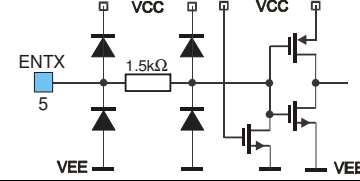
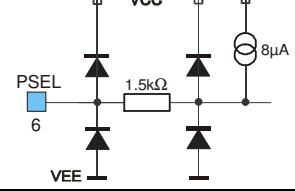
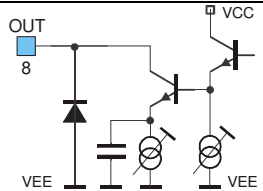

Fig. 5: Timing diagrams for FSK and ASK modulation

3 Pin Definition and Description

Pin No.	Name	I/O Type	Functional Schematic	Description
1	ASKDTA	input		<p>ASK data input, CMOS compatible with operation mode dependent pull-up circuit</p> <p>TX standby: no pull-up TX active: pull up</p>
2	FSKDTA	input		<p>FSK data input, CMOS compatible with operation mode dependent pull-up circuit</p> <p>TX standby: no pull-up TX active: pull up</p>
3	FSKSW	analog I/O		XOSC FSK pulling pin, MOS switch
4	ROI	analog I/O		XOSC connection to XTAL, Colpitts type crystal oscillator
5	ENTX	input		mode control input, CMOS-compatible with internal pull-down circuit
6	PSEL	analog I/O		<p>power select input, high impedance comparator logic</p> <p>TX standby: $I_{PSEL} = 0$ TX active: $I_{PSEL} = 8\mu A$</p>
7	VEE	ground		negative power supply
8	OUT	output		power amplifier output, open collector
9	VEE	ground		negative power supply
10	VCC	supply		positive power supply

4 Electrical Characteristics

4.1 Absolute Maximum Ratings

Parameter	Symbol	Condition	Min	Max	Unit
	V_{CC}		0	7.0	V
Input voltage	V_{IN}		-0.3	$V_{CC}+0.3$	V
Storage temperature	T_{STG}		-65	150	°C
Junction temperature	T_J			150	°C
Thermal Resistance	R_{thJA}			49	K/W
Power dissipation	P_{diss}			0.12	W
Electrostatic discharge	V_{ESD}	human body model (HBM) according to CDF-AEC-Q100-002	±2.0		kV

4.2 Normal Operating Conditions

Parameter	Symbol	Condition	Min	Max	Unit
Supply voltage	V_{CC}		1.95	5.5	V
Operating temperature	T_A		-40	125	°C
Input low voltage CMOS	V_{IL}	ENTX, DTA pins		$0.3 \cdot V_{CC}$	V
Input high voltage CMOS	V_{IH}	ENTX, DTA pins	$0.7 \cdot V_{CC}$		V
XOSC frequency	f_{ref}	set by the crystal	26.6	29	MHz
VCO frequency	f_c	$f_c = 32 \cdot f_{ref}$	850	930	MHz
FSK deviation	Δf	depending on CX1, CX2 and crystal parameters	±2.5	±60	kHz
FSK Data rate	R	NRZ		40	kbit/s
ASK Data rate	R	NRZ		40	kbit/s

4.3 Crystal Parameters

Parameter	Symbol	Condition	Min	Max	Unit
Crystal frequency	f_0	fundamental mode, AT	26.6	29	MHz
Load capacitance	C_L		10	15	pF
Static capacitance	C_0			7	pF
Series resistance	R_1			50	Ω
Spurious response	a_{spur}	only required for FSK		-10	dB

4.4 DC Characteristics

all parameters under normal operating conditions, unless otherwise stated;
typical values at $T_A = 23\text{ °C}$ and $V_{CC} = 3\text{ V}$

Parameter	Symbol	Condition	Min	Typ	Max	Unit
Operating Currents						
Standby current	I_{SBY}	ENTX=0, $T_A=85\text{ °C}$		0.2	200	nA
		ENTX=0, $T_A=125\text{ °C}$			4	μA
Supply current in power step 0	I_{CC0}	ENTX=1	2.5	3.9	5.7	mA
Supply current in power step 1	I_{CC1}	ENTX=1	3.5	5.1	7.3	mA
Supply current in power step 2	I_{CC2}	ENTX=1	4.5	6.4	8.8	mA
Supply current in power step 3	I_{CC3}	ENTX=1	6.2	8.6	11.4	mA
Supply current in power step 4	I_{CC4}	ENTX=1	9.4	13.4	17.3	mA
Digital Pin Characteristics						
Input low voltage CMOS	V_{IL}	ENTX, DTA pins	-0.3		$0.3 \cdot V_{CC}$	V
Input high voltage CMOS	V_{IH}	ENTX, DTA pins	$0.7 \cdot V_{CC}$		$V_{CC} + 0.3$	V
Pull down current ENTX pin	I_{PDEN}	ENTX=1	0.2	2.0	20	μA
Low level input current ENTX pin	I_{INLEN}	ENTX=0			0.02	μA
High level input current DTA pins	I_{INHDTA}	FSKDTA=1 ASKDTA=1			0.02	μA
Pull up current DTA pins active	I_{PUDTAa}	FSKDTA=0, ASKDTA=0, ENTX=1	0.1	1.5	12	μA
Pull up current DTA pins standby	I_{PUDTAs}	FSKDTA=0, ASKDTA=0, ENTX=0			0.02	μA
FSK Switch Resistance						
MOS switch On resistance	R_{ON}	FSKDTA=0 ENTX=1		20	70	Ω
MOS switch Off resistance	R_{OFF}	FSKDTA=1 ENTX=1	1			M Ω
Power Select Characteristics						
Power select current	I_{PSEL}	ENTX=1	7.0	8.6	9.9	μA
Power select voltage step 0	V_{PS0}	ENTX=1			0.035	V
Power select voltage step 1	V_{PS1}	ENTX=1	0.14		0.24	V
Power select voltage step 2	V_{PS2}	ENTX=1	0.37		0.60	V
Power select voltage step 3	V_{PS3}	ENTX=1	0.78		1.29	V
Power select voltage step 4	V_{PS4}	ENTX=1	1.55			V
Low Voltage Detection Characteristic						
Low voltage detect threshold	V_{LVD}	ENTX=1	1.75	1.85	1.95	V

4.5 AC Characteristics

all parameters under normal operating conditions, unless otherwise stated;
typical values at $T_A = 23\text{ °C}$ and $V_{CC} = 3\text{ V}$; test circuit shown in Fig. 18, $f_c = 868.3\text{ MHz}$

Parameter	Symbol	Condition	Min	Typ	Max	Unit
CW Spectrum Characteristics						
Output power in step 0 (Isolation in off-state)	P_{off}	ENTX=1			-70	dBm
Output power in step 1	P_1	ENTX=1	-13	-12	-11 ¹⁾	dBm
Output power in step 2	P_2	ENTX=1	-4	-3	-2 ¹⁾	dBm
Output power in step 3	P_3	ENTX=1	1	2.5	3.5 ¹⁾	dBm
Output power in step 4	P_4	ENTX=1	4	7.5	9.5 ¹⁾	dBm
Phase noise	$L(f_m)$	@ 200kHz offset		-87	-82	dBc/Hz
Spurious emissions according to EN 300 220-1 (2000.09) table 13	P_{spur}	47MHz < f < 74MHz			-54	dBm
		87.5MHz < f < 118MHz				
		174MHz < f < 230MHz				
		470MHz < f < 862MHz				
		B=100kHz				
		f < 1GHz, B=100kHz			-36	dBm
		f > 1GHz, B=1MHz			-30	dBm
Start-up Parameters						
Start-up time	t_{on}	from standby to transmit mode		0.6	1	ms
Frequency Stability						
Frequency stability vs. supply voltage	df_{VCC}				±3	ppm
Frequency stability vs. temperature	df_{TA}	crystal at constant temperature			±10	ppm
Frequency stability vs. variation range of C_{RO}	df_{CRO}				±20	ppm

1) output matching network tuned for 5V supply

4.6 Output Power Steps

Power step	0	1	2	3	4
RPS / kΩ	< 3	22	56	120	not connected

5 Typical Operating Characteristics

5.1 DC Characteristics

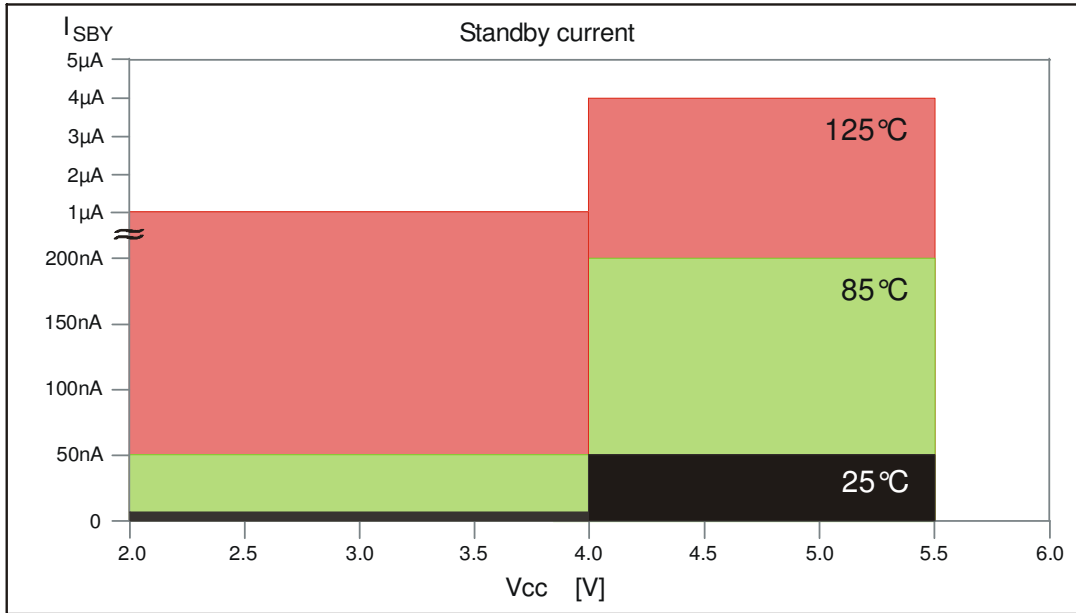

Fig. 6: Standby current limits

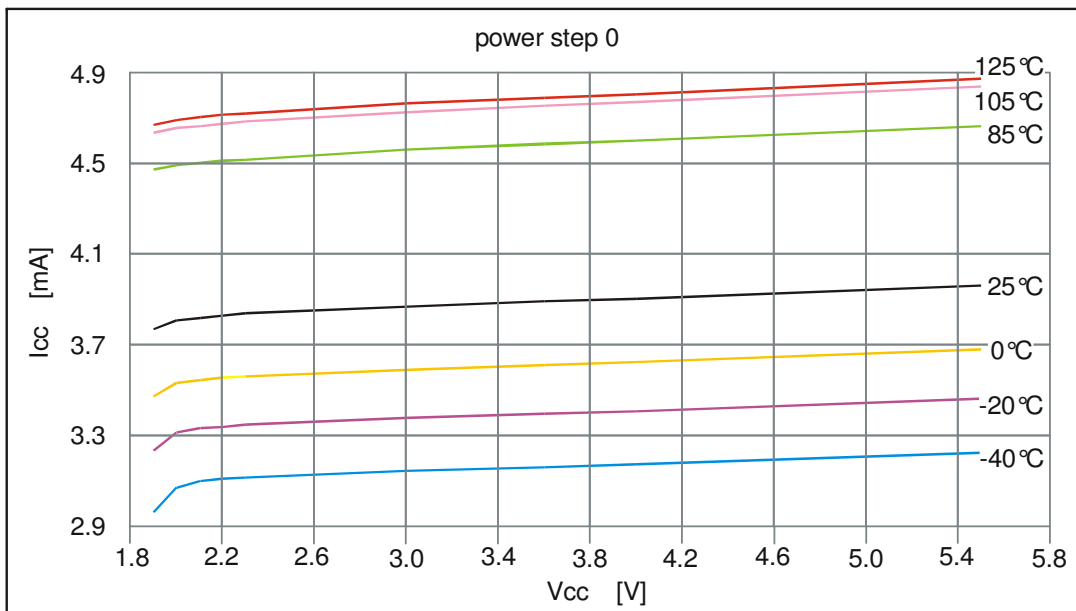

Fig. 7: Supply current in power step 0

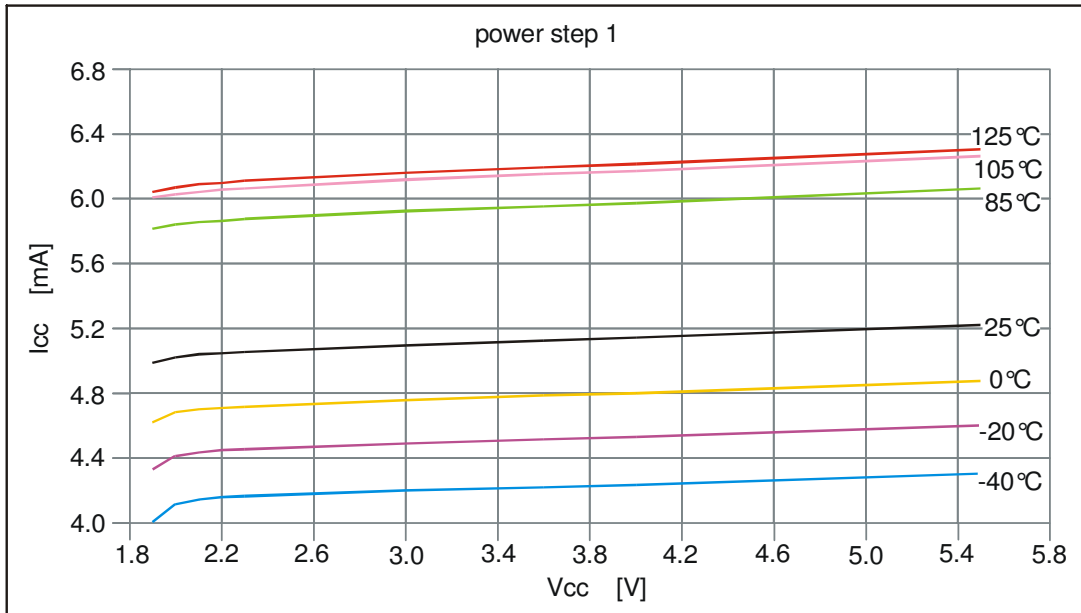

Fig. 8: Supply current in power step 1

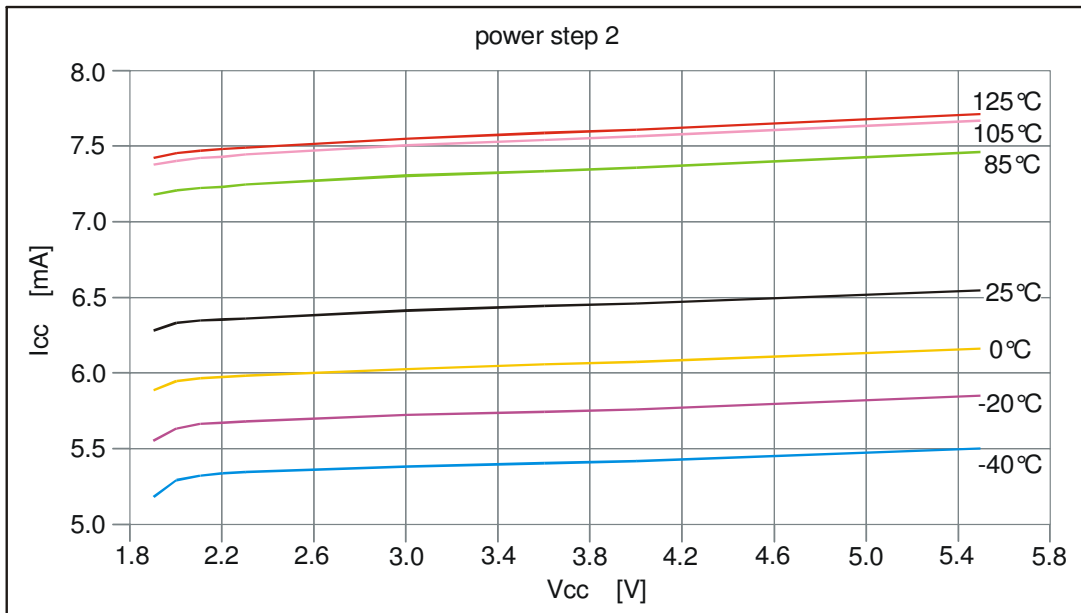

Fig. 9: Supply current in power step 2

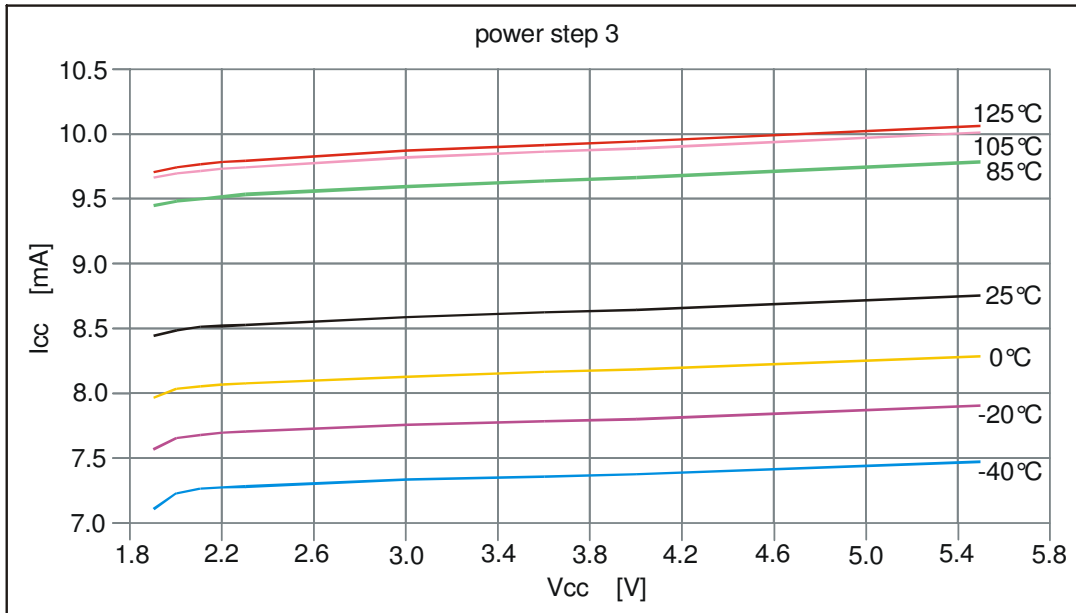

Fig. 10: Supply current in power step 3

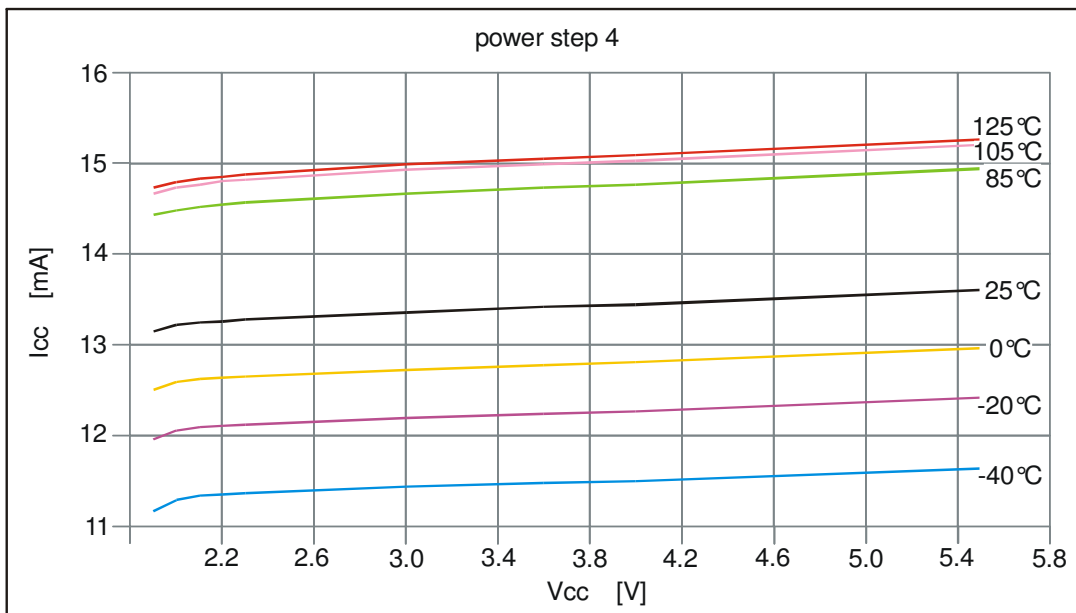

Fig. 11: Supply current in power step 4

5.2 AC Characteristics

- Data according to test circuit in Fig. 18 (868.3MHz)

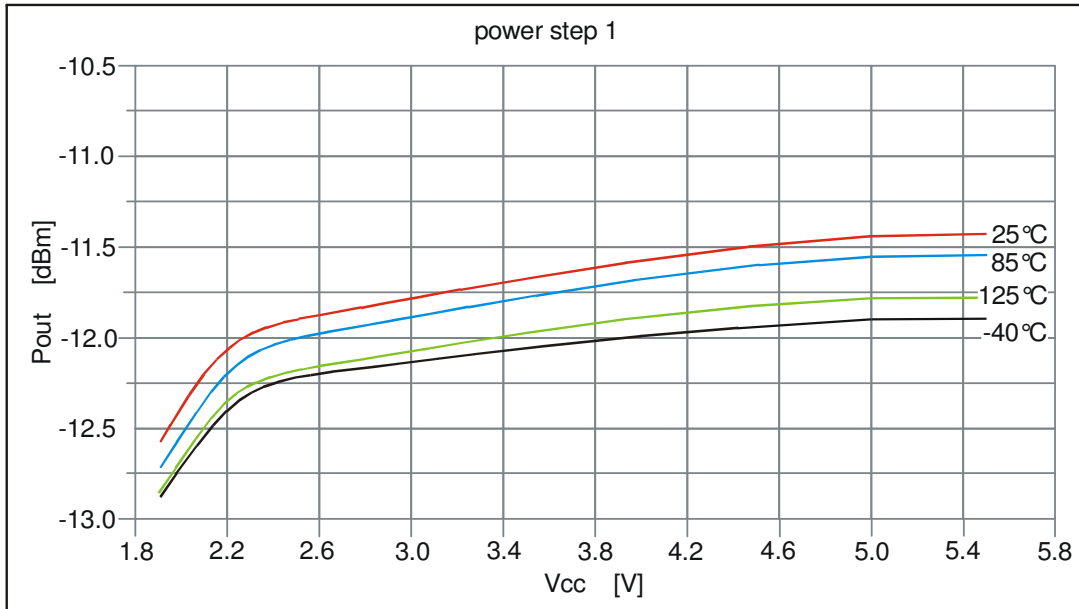

Fig. 12: Output power in step 1

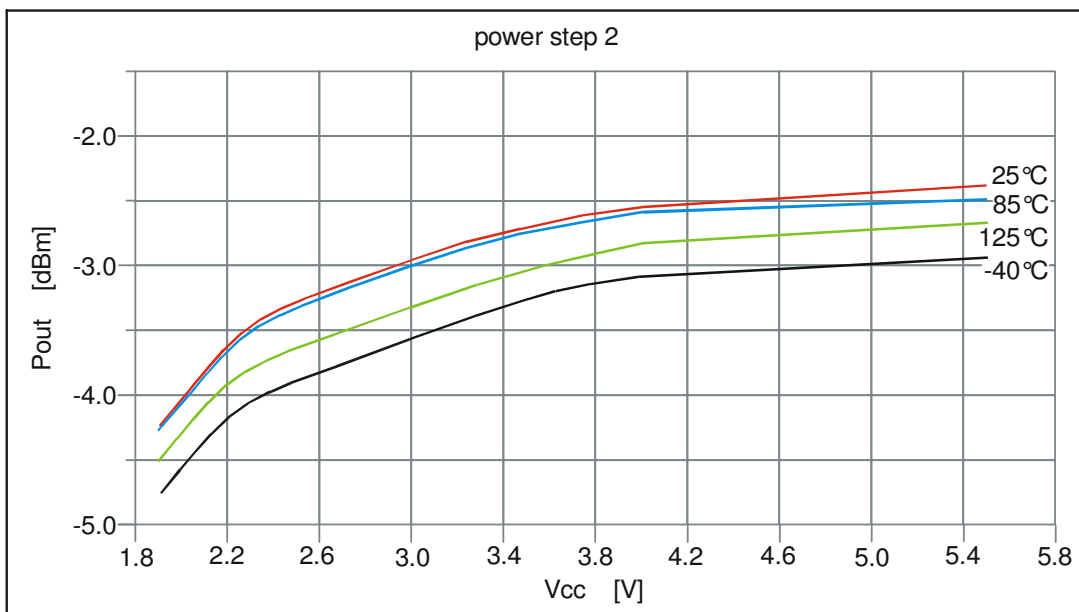

Fig. 13: Output power in step 2

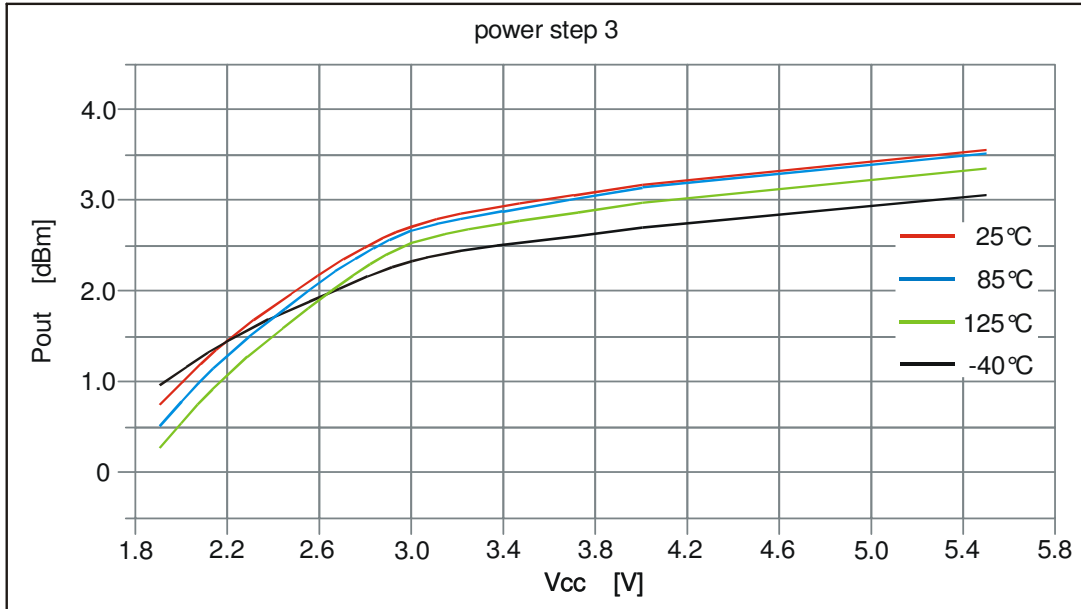

Fig. 14: Output power in step 3

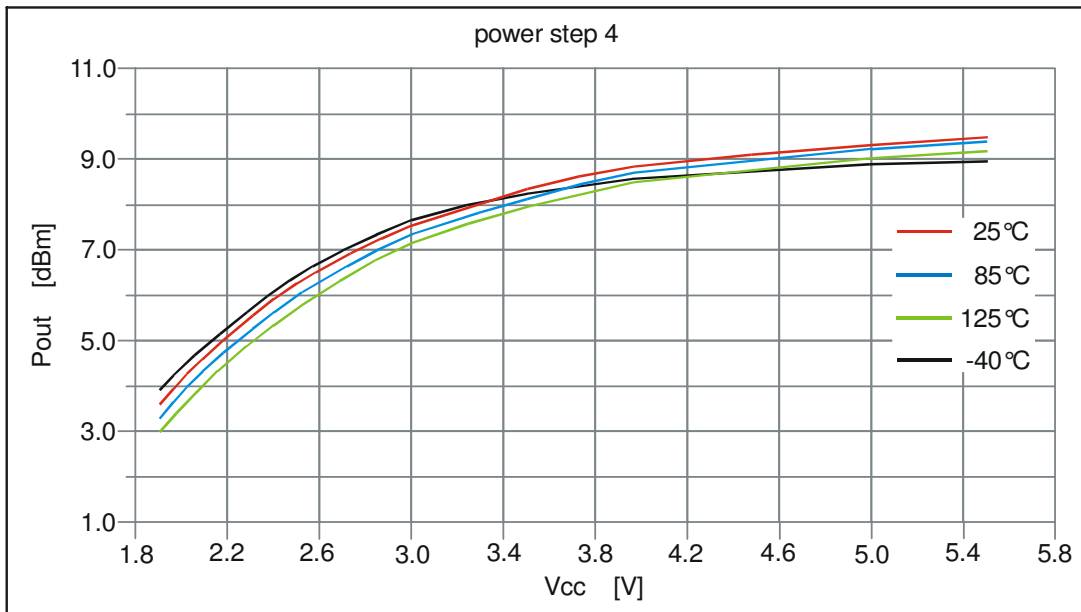

Fig. 15: Output power in step 4

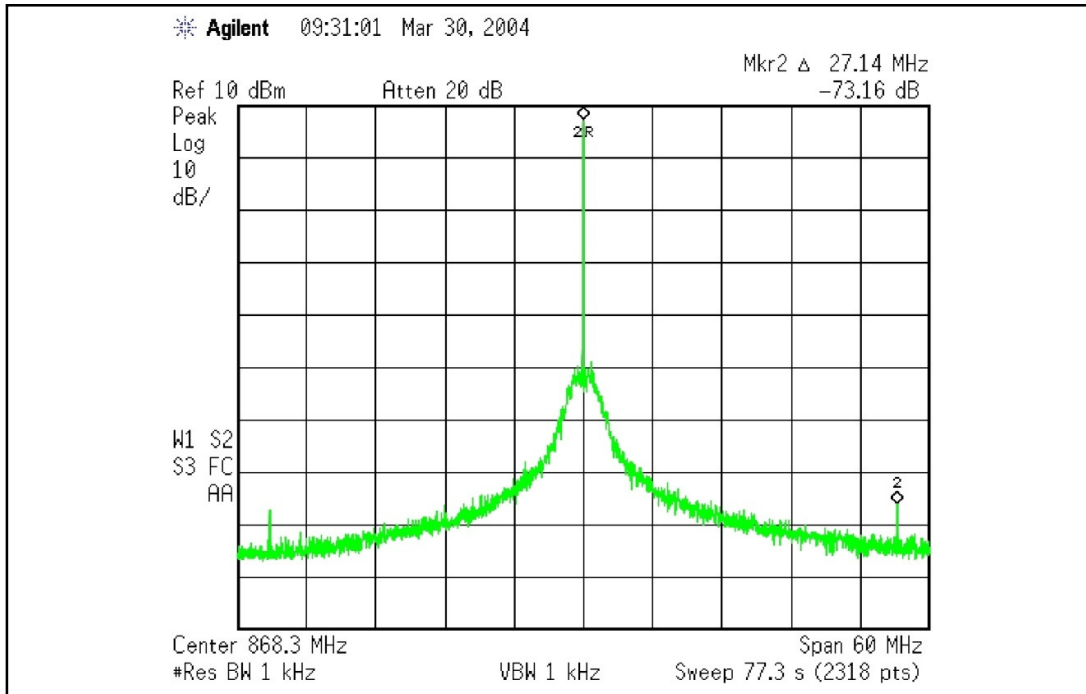

Fig.16: RF output signal with PLL reference spurs

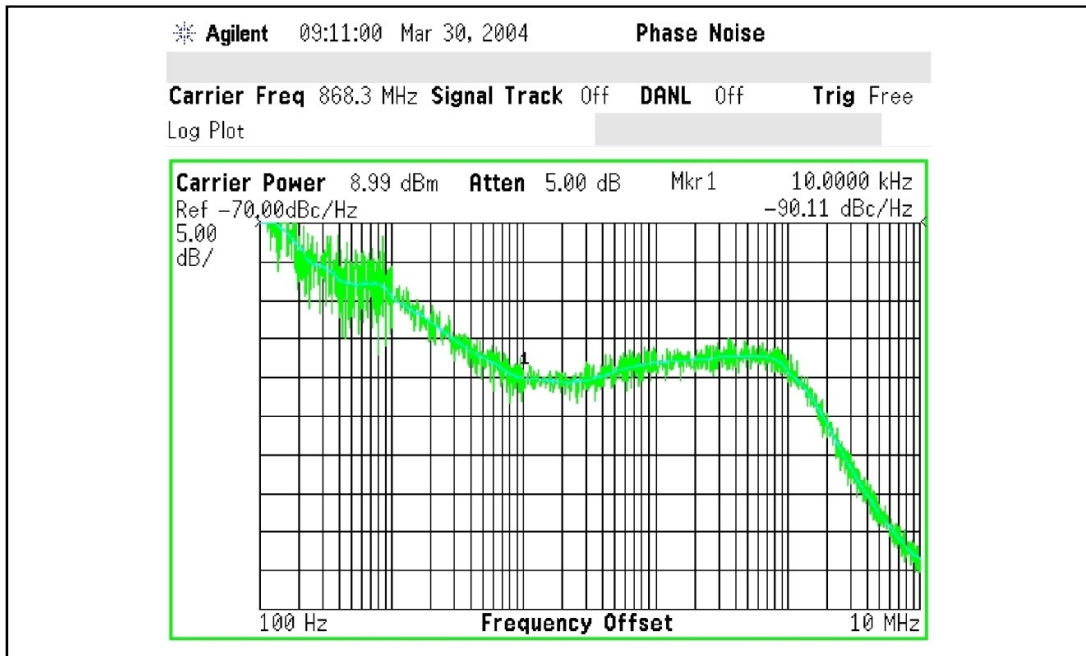

Fig.17: Single sideband phase noise

6 Test Circuit

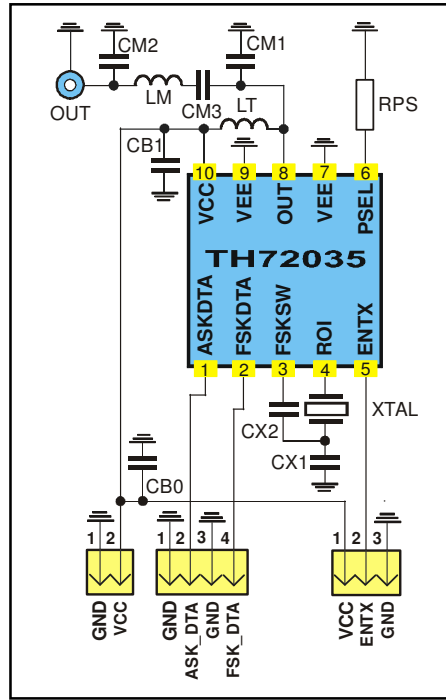

Fig. 18: Test circuit for FSK and ASK with 50 Ω matching network

6.1 Test circuit component list to Fig. 18

Part	Size	Value @ 868.3 MHz	Value @ 915 MHz	Tolerance	Description
CM1	0805	1.8 pF	2.2 pF	$\pm 5\%$	impedance matching capacitor
CM2	0805	5.6 pF	5.6 pF	$\pm 5\%$	impedance matching capacitor
CM3	0805	68 pF	68 pF	$\pm 5\%$	impedance matching capacitor
LM	0805	12 nH	10 nH	$\pm 5\%$	impedance matching inductor, note 2
LT	0805	15 nH	10 nH	$\pm 5\%$	output tank inductor, note 2
CX1_FSK	0805	18 pF	18 pF	$\pm 5\%$	XOSC FSK capacitor ($\Delta f = \pm 20$ kHz), note 1
CX1_ASK	0805	27 pF	27 pF	$\pm 5\%$	XOSC ASK capacitor, trimmed to f_c , note 1
CX2	0805	10 pF	10 pF	$\pm 5\%$	XOSC capacitor ($\Delta f = \pm 20$ kHz), note 1 only needed for FSK
RPS	0805	see section 4.6		$\pm 5\%$	power-select resistor
CB0	0805	220 nF		$\pm 20\%$	de-coupling capacitor
CB1	0805	330 pF		$\pm 10\%$	de-coupling capacitor
XTAL	HC49/S	27.13438 MHz	28.59375 MHz	± 30 ppm calibr. ± 30 ppm temp.	fundamental wave crystal, $C_L = 12$ pF, $C_{0, max} = 7$ pF, $R_1 = 40$ Ω

Note 1: value depending on crystal parameters

Note 2: for high-power applications high-Q wire-wound inductors should be used

7 Package Description

The device is RoHS compliant.

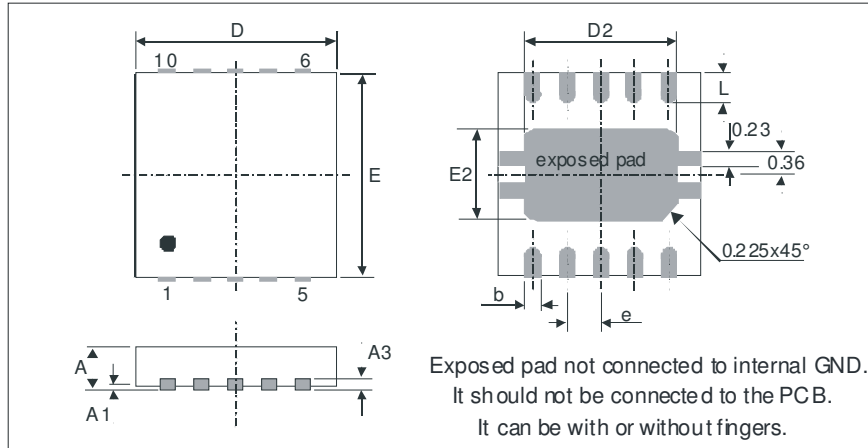

Fig. 7: 10L QFN 3x3 Dual

all Dimensions in mm										
	D	E	D2	E2	A	A1	A3	L	e	b
min	2.85	2.85	2.23	1.49	0.80	0	0.20	0.3	0.50	0.18
max	3.15	3.15	2.48	1.74	1.00	0.05	0.20	0.5	0.50	0.30
all Dimensions in inch										
	D	E	D2	E2	A	A1	A3	L	e	b
min	0.112	0.112	0.0878	0.051	0.0315	0	0.0079	0.0118	0.0197	0.0071
max	0.124	0.124	0.0976	0.055	0.0393	0.002	0.0079	0.0197	0.0197	0.0118

7.1 Soldering Information

- The device is qualified for MSL1 with soldering peak temperature 260 deg C according to JEDEC J-STD-20.

7.2 Recommended PCB Footprints

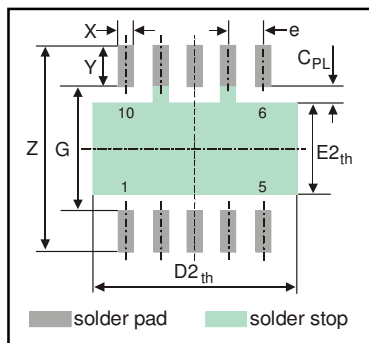

all Dimensions in mm								
	Z	G	D2 _{th}	E2 _{th}	X	Y	C _{PL}	e
min	3.55	1.9	3.2	1.3	0.25	0.7	0.3	0.5
max	3.90	2.3	3.6	1.7	0.30	1.0	0.5	0.5
all Dimensions in inch								
	Z	G	D2 _{th}	E2 _{th}	X	Y	C _{PL}	e
min	0.1398	0.0748	0.1260	0.0512	0.0098	0.0276	0.0591	0.0197
max	0.1535	0.0906	0.1417	0.0669	0.0118	0.0394	0.0197	0.0197

Fig. 8: PCB land pattern style

8 Standard information regarding manufacturability of Melexis products with different soldering processes

Our products are classified and qualified regarding soldering technology, solderability and moisture sensitivity level according to following test methods:

Reflow Soldering SMD's (Surface Mount Devices)

- IPC/JEDEC J-STD-020
Moisture/Reflow Sensitivity Classification for Nonhermetic Solid State Surface Mount Devices (classification reflow profiles according to table 5-2)
- EIA/JEDEC JESD22-A113
Preconditioning of Nonhermetic Surface Mount Devices Prior to Reliability Testing (reflow profiles according to table 2)

Wave Soldering SMD's (Surface Mount Devices) and THD's (Through Hole Devices)

- EN60749-20
Resistance of plastic- encapsulated SMD's to combined effect of moisture and soldering heat
- EIA/JEDEC JESD22-B106 and EN60749-15
Resistance to soldering temperature for through-hole mounted devices

Iron Soldering THD's (Through Hole Devices)

- EN60749-15
Resistance to soldering temperature for through-hole mounted devices

Solderability SMD's (Surface Mount Devices) and THD's (Through Hole Devices)

- EIA/JEDEC JESD22-B102 and EN60749-21
Solderability

For all soldering technologies deviating from above mentioned standard conditions (regarding peak temperature, temperature gradient, temperature profile etc) additional classification and qualification tests have to be agreed upon with Melexis.

The application of Wave Soldering for SMD's is allowed only after consulting Melexis regarding assurance of adhesive strength between device and board.

Melexis is contributing to global environmental conservation by promoting **lead free** solutions. For more information on qualifications of **RoHS** compliant products (RoHS = European directive on the Restriction Of the use of certain Hazardous Substances) please visit the quality page on our website:
<http://www.melexis.com/quality.aspx>

9 ESD Precautions

Electronic semiconductor products are sensitive to Electro Static Discharge (ESD). Always observe Electro Static Discharge control procedures whenever handling semiconductor products.

10 Disclaimer

Devices sold by Melexis are covered by the warranty and patent indemnification provisions appearing in its Term of Sale. Melexis makes no warranty, express, statutory, implied, or by description regarding the information set forth herein or regarding the freedom of the described devices from patent infringement. Melexis reserves the right to change specifications and prices at any time and without notice. Therefore, prior to designing this product into a system, it is necessary to check with Melexis for current information. This product is intended for use in normal commercial applications. Applications requiring extended temperature range, unusual environmental requirements, or high reliability applications, such as military, medical life-support or life-sustaining equipment are specifically not recommended without additional processing by Melexis for each application.

The information furnished by Melexis is believed to be correct and accurate. However, Melexis shall not be liable to recipient or any third party for any damages, including but not limited to personal injury, property damage, loss of profits, loss of use, interrupt of business or indirect, special incidental or consequential damages, of any kind, in connection with or arising out of the furnishing, performance or use of the technical data herein. No obligation or liability to recipient or any third party shall arise or flow out of Melexis' rendering of technical or other services.

© 2012 Melexis NV. All rights reserved.

For the latest version of this document, go to our website at
www.melexis.com

Or for additional information contact Melexis Direct:

Europe, Africa, Asia:	America:
Phone: +32 1367 0495	Phone: +1 248 306 5400
E-mail: sales_europe@melexis.com	E-mail: sales_usa@melexis.com

ISO/TS 16949 and ISO14001 Certified