



Chipsmall Limited consists of a professional team with an average of over 10 year of expertise in the distribution of electronic components. Based in Hongkong, we have already established firm and mutual-benefit business relationships with customers from,Europe,America and south Asia,supplying obsolete and hard-to-find components to meet their specific needs.

With the principle of "Quality Parts,Customers Priority,Honest Operation,and Considerate Service",our business mainly focus on the distribution of electronic components. Line cards we deal with include Microchip,ALPS,ROHM,Xilinx,Pulse,ON,Everlight and Freescale. Main products comprise IC,Modules,Potentiometer,IC Socket,Relay,Connector.Our parts cover such applications as commercial,industrial, and automotives areas.

We are looking forward to setting up business relationship with you and hope to provide you with the best service and solution. Let us make a better world for our industry!



Contact us

Tel: +86-755-8981 8866 Fax: +86-755-8427 6832

Email & Skype: info@chipsmall.com Web: www.chipsmall.com

Address: A1208, Overseas Decoration Building, #122 Zhenhua RD., Futian, Shenzhen, China



REV. Status

PRELIMINARY
05/17/02 LL

PRELIMINARY 1
CHANGED
SCHEMATIC
05/28/02 LL



RJ45 Integrated Connector

10/100 Base-TX, 1X4, Through Hole, LEDs, Tap Down

MODEL NUMBER
TIC-L044-14

- Meets IEEE 802.3 and ANSI X3.263
- Operating temperature: 0°C to +70°C
- Storage Temperature: -40°C to +75°C

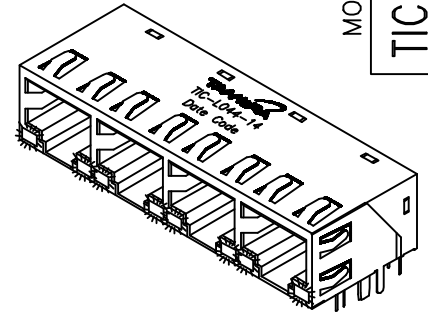

Package Information			
Weight		Quantity	
weight/pcs (g)	weight/carton (kg)	quantity/tray (pcs)	quantity/carton (pcs)
23.4	4.0	25	100

Electrical Specification @ 25°C								
Insertion Loss (dB Max)	Return Loss (dB Min)			CMRR (dB Min)	Crosstalk (dB Min)	OCL (μH Min)	Hipot (Vrms)	Impedance (Ω)
1-100 MHz	1-30 MHz	60 MHz	80 MHz	1-100 MHz	1-100 MHz	8mA Dc Bias	1 minute	
-1	-18	-16	-12	-30	-35	350	1500	100

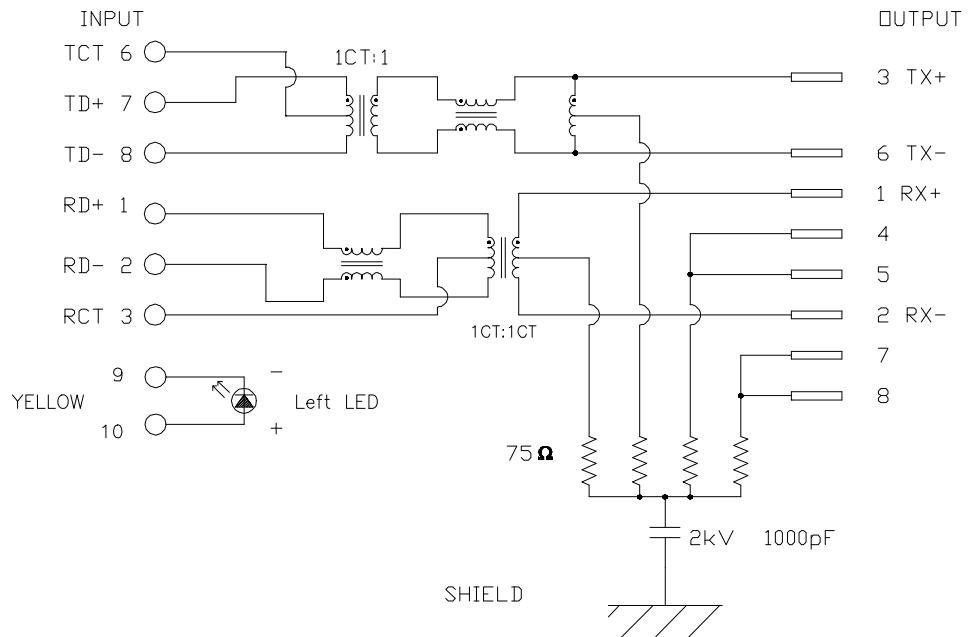
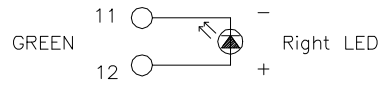

PREPARED BY:

D. Rund

ENGINEER:

L. Le

QUALITY CONTROL:

D. Kelley

APPROVED:

J. Coleman

DWG CONTROL NO.
P-A1-13059
ACAD\TTC\A1130591.DWG

REV
PR1

RJ45
INTEGRATED CONNECTOR

TAMURA CORPORATION OF AMERICA
43352 BUSINESS PARK DRIVE, TEMECULA, CA. 92590-6624
(909) 699-1270 FAX 9096769482

TIC-L044-14
MODEL SPECIFICATION

DIM: mm(in) SCL: NONE SH: 1 OF 3

PROPRIETARY NOTICE: THIS DRAWING PRINT OR DOCUMENT AND SUBJECT MATTER DISCLOSED HEREIN ARE PROPRIETARY ITEMS TO WHICH TAMURA RETAINS THE EXCLUSIVE RIGHT OF DISSEMINATION, REPRODUCTION, MANUFACTURE AND SALE. THIS DRAWING, PRINT OR DOCUMENT IS SUBMITTED IN CONFIDENCE FOR CONSIDERATION BY THE RECIPIENT ALONE UNLESS PERMISSION FOR FURTHER DISCLOSURE IS EXPRESSLY GRANTED IN WRITING.

REV. Status

PRELIMINARY
05/17/02 LL

PRELIMINARY 1
CHANGED
SCHEMATIC
05/28/02 LL



RJ45 Integrated Connector

10/100 Base-TX, 1X4, Through Hole, LEDs, Tap Down

Mechanical Material Specification

Contact									Plastic Part		Shell	
Contact Finish									Housing and Insert	Trans-parent	Front	Back
RJ Contact			LED and Joint Contacts									
Contact Material	Contact Area	Solder Tail	Under-plating	LED Contact Material	Joint Contact Material	Contact Area	Solder Tail Area	Under-plating				
Phosphor Bronze	Gold	Tin/Lead (9:1)	Nickel	Phosphor Bronze	Brass	Brass	Tin/Lead (9:1)	Nickel	Thermal-plastic PA6T	Thermal-plastic PC	Stainless SUS304 -1/2H	Stainless SUS304 -1/2H
0.30mm thick	30μ" MIN	100μ" MIN	50μ" MIN	0.30mm thick	0.30mm thick	100μ" MIN	100μ" MIN	50μ" MIN	Black UL94V-0	Transparent UL94V-0	0.20mm thick	0.20mm thick

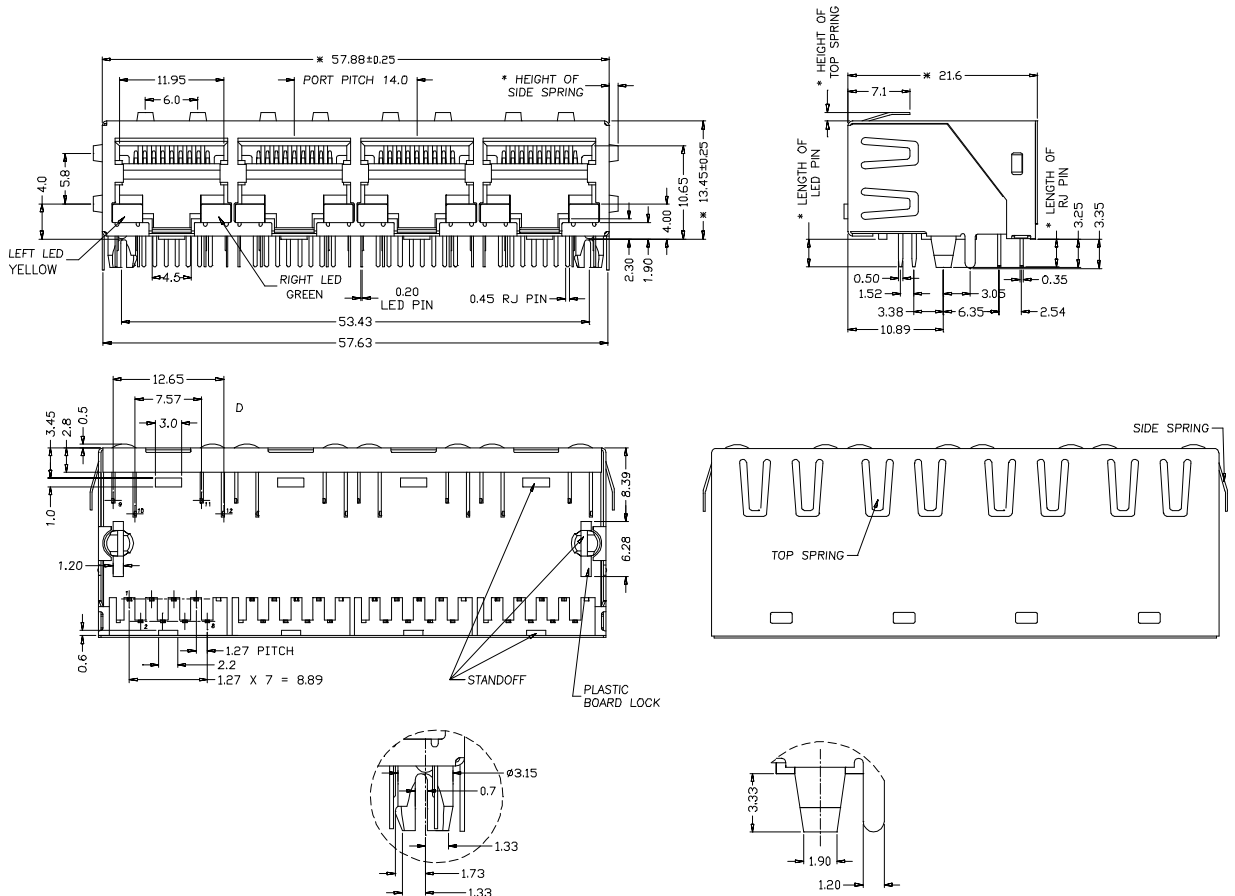

PREPARED BY:

D. Rund

NOTE: Dimension tolerances are ±0.25[0.010]

ENGINEER:

L. Le

DWG CONTROL NO. P-A1-13059
ACAD\TTC\A1130592.DWG

REV PR1

RJ45
INTEGRATED CONNECTOR

QUALITY CONTROL:

D. Kelley

CONTENTS OF THIS DRAWING ARE SUBJECT TO CHANGE WITHOUT PRIOR NOTICE

TAMURA CORPORATION OF AMERICA
43352 BUSINESS PARK DRIVE, TEMECULA, CA. 92590-6624
(909) 699-1270 FAX 9096769482

TIC-L044-14

MODEL SPECIFICATION

DIM: MM[IN] SCL: NONE SH: 2 OF 3

APPROVED:

J. Coleman

PROPRIETARY NOTICE: THIS DRAWING PRINT OR DOCUMENT AND SUBJECT MATTER DISCLOSED HEREIN ARE PROPRIETARY ITEMS TO WHICH TAMURA RETAINS THE EXCLUSIVE RIGHT OF DISSEMINATION, REPRODUCTION, MANUFACTURE AND SALE. THIS DRAWING, PRINT OR DOCUMENT IS SUBMITTED IN CONFIDENCE FOR CONSIDERATION BY THE RECIPIENT ALONE UNLESS PERMISSION FOR FURTHER DISCLOSURE IS EXPRESSLY GRANTED IN WRITING.

REV. Status

PRELIMINARY
05/17/02 LL

PRELIMINARY 1
CHANGED
SCHEMATIC
05/28/02 LL



RJ45 Integrated Connector

10/100 Base-TX, 1X4, Through Hole, LEDs, Tap Down

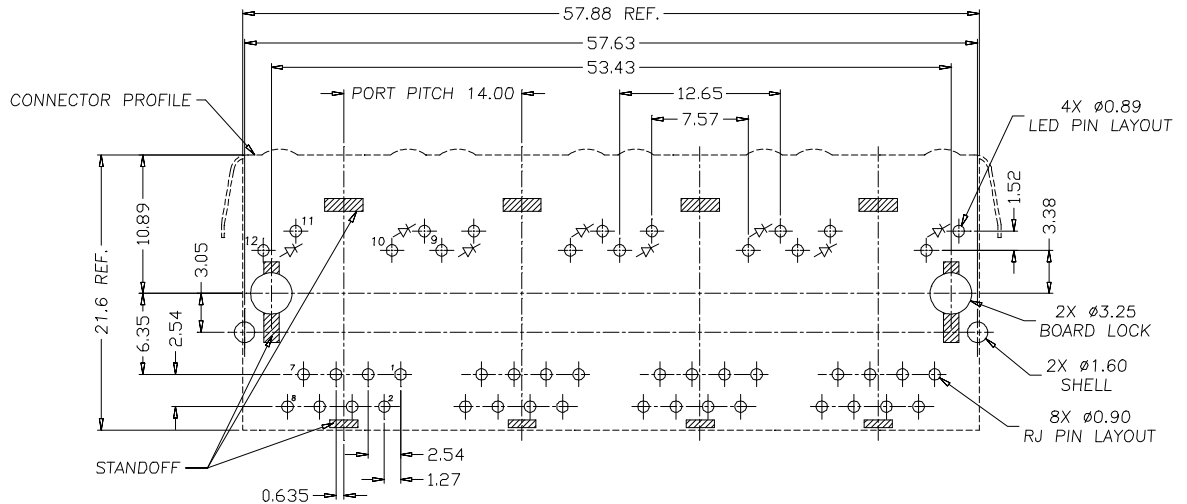

RECOMMENDED PCB LAYOUT
COMPONENT SIDE
ALL DIMENSION TOLERANCE ARE $\pm 0.05\text{mm}$ UNLESS OTHERWISE SPECIFIED

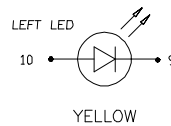
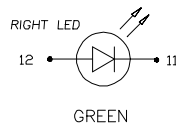

PREPARED BY:

D. Rund

NOTE: Dimension tolerances are $\pm 0.25[0.010]$

ENGINEER:

L. Le

DWG CONTROL NO.
P-A1-13059
ACAD\TTC\A1130593.DWG

REV
PR1

RJ45
INTEGRATED CONNECTOR

TIC-L044-14

QUALITY CONTROL:

D. Kelley

CONTENTS OF THIS DRAWING ARE
SUBJECT TO CHANGE WITHOUT
PRIOR NOTICE

TAMURA CORPORATION OF AMERICA
43352 BUSINESS PARK DRIVE, TEMECULA, CA. 92590-6624
(909) 699-1270 FAX 9096769482

MODEL SPECIFICATION

DIM: MM[IN] | SCL: NONE | SH: 3 OF 3

APPROVED:

J. Coleman

PROPRIETARY NOTICE: THIS DRAWING PRINT OR DOCUMENT AND SUBJECT MATTER DISCLOSED HEREIN ARE PROPRIETARY ITEMS TO WHICH TAMURA RETAINS THE EXCLUSIVE RIGHT OF DISSEMINATION, REPRODUCTION, MANUFACTURE AND SALE. THIS DRAWING, PRINT OR DOCUMENT IS SUBMITTED IN CONFIDENCE FOR CONSIDERATION BY THE RECIPIENT ALONE UNLESS PERMISSION FOR FURTHER DISCLOSURE IS EXPRESSLY GRANTED IN WRITING.