



Chipsmall Limited consists of a professional team with an average of over 10 year of expertise in the distribution of electronic components. Based in Hongkong, we have already established firm and mutual-benefit business relationships with customers from,Europe,America and south Asia,supplying obsolete and hard-to-find components to meet their specific needs.

With the principle of “Quality Parts,Customers Priority,Honest Operation,and Considerate Service”,our business mainly focus on the distribution of electronic components. Line cards we deal with include Microchip,ALPS,ROHM,Xilinx,Pulse,ON,Everlight and Freescale. Main products comprise IC,Modules,Potentiometer,IC Socket,Relay,Connector.Our parts cover such applications as commercial,industrial, and automotives areas.

We are looking forward to setting up business relationship with you and hope to provide you with the best service and solution. Let us make a better world for our industry!



Contact us

Tel: +86-755-8981 8866 Fax: +86-755-8427 6832

Email & Skype: info@chipsmall.com Web: www.chipsmall.com

Address: A1208, Overseas Decoration Building, #122 Zhenhua RD., Futian, Shenzhen, China



MODEL TL-2450

TECHNICAL DATA

(Typical values @+25°C for batteries stored for one year or less)

- Nominal capacity @ 0.5 mA, to 2V 0.55 Ah
- Rated voltage 3.6 V
- Maximum recommended continuous current 5 mA
- Maximum pulse current capability 10 mA
- Weight 8.8g (0.310 oz)
- Volume 2.60 cc
- Operating temperature range -55°C to +85°C
- Li metal content approx. 0.2 g
- U.L. Component Recognition MH 12193

TADIRAN LITHIUM BATTERIES

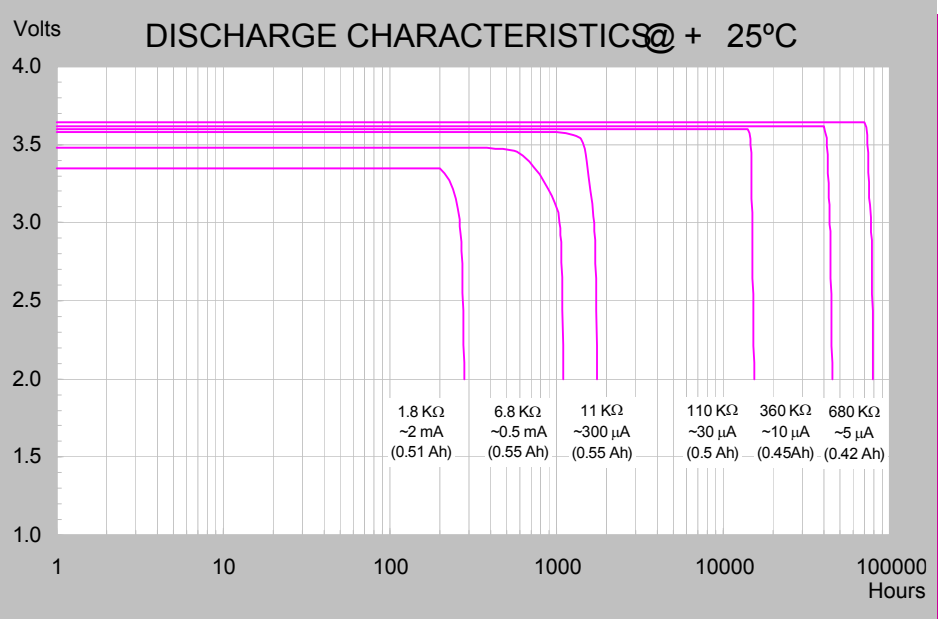
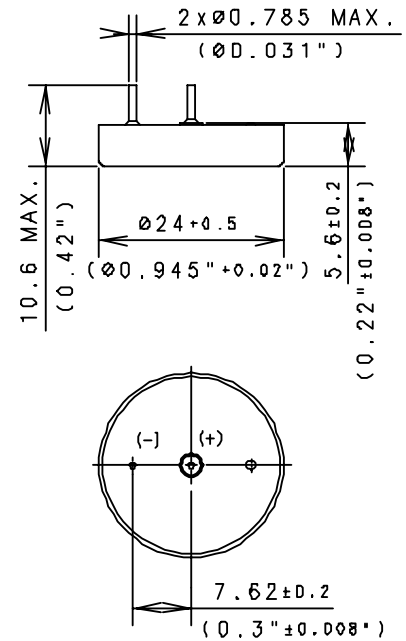

ADDITIONAL INFORMATION

SUFFIX- /P TIN PLATED NICKEL PINS
 CATALOGUE NO.: 15-2450-41020

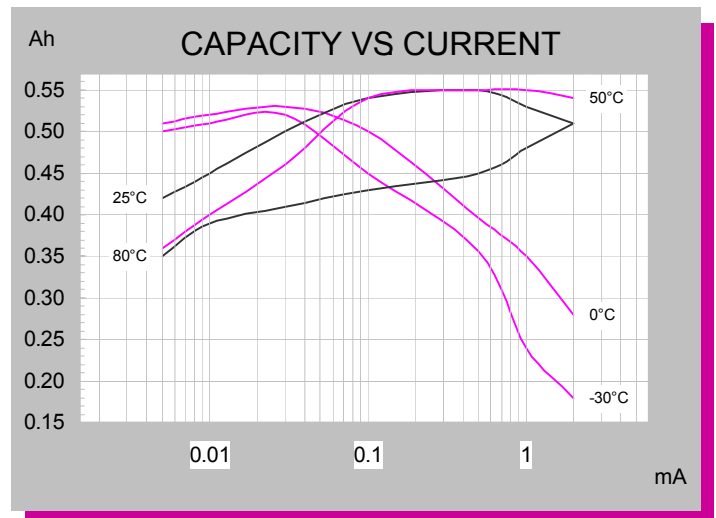
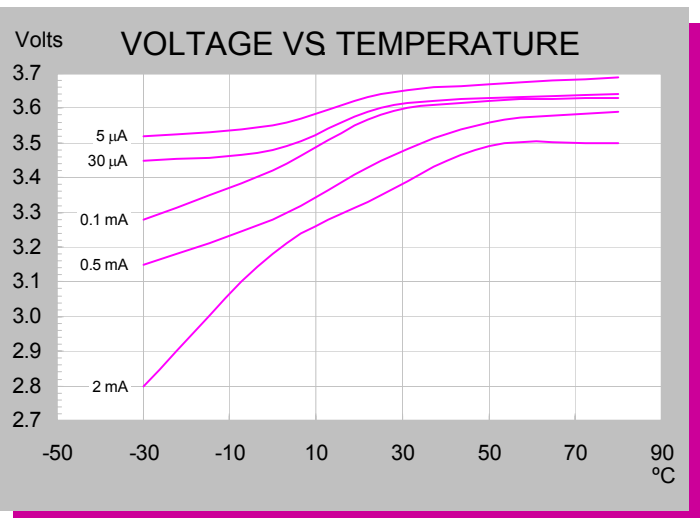

iXtra - Long Term High Performance

Note: Any presentations in this data sheet concerning performance are for information purpose only and are not construed as warranties either expressed or implied, of future performance. Rev. B 02/11 ECN 1502262

TL-2450

CELL FEATURES

- 3.6 V Primary lithium-thionyl chloride (Li-SOCl₂)
- Fast voltage recovery after long term storage and/or usage
- High energy density
- High and stable operating voltage
- Low self discharge rate
- 10 years shelf life
- Wafer construction
- Hermetic glass-to-metal-sealing
- Non-flammable electrolyte
- Non-restricted for transportation

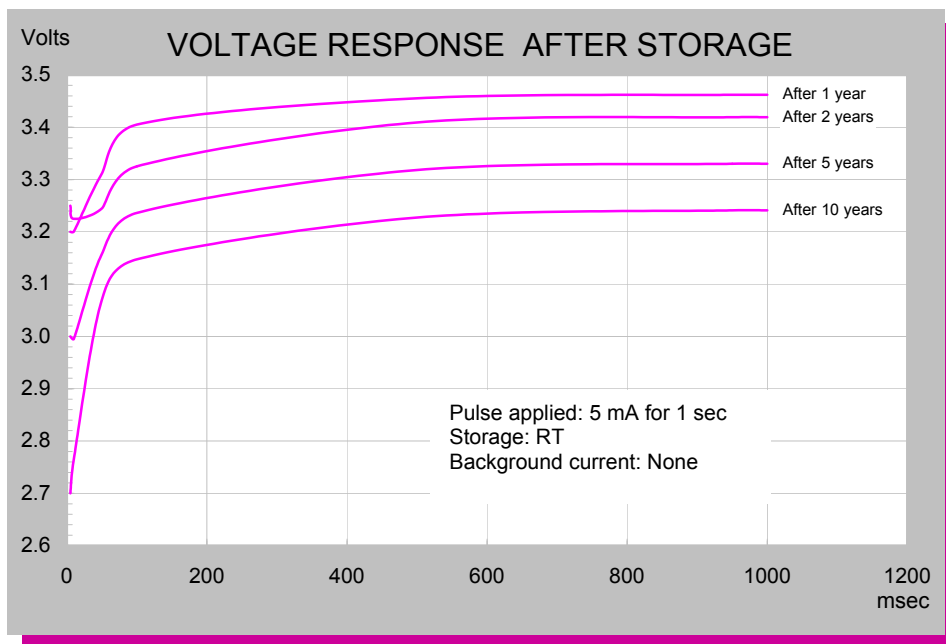

TADIRAN LITHIUM BATTERIES

MAIN APPLICATIONS

- Utility meters (elect., water & gas)
- Automatic meter reading
- RF systems
- Sensors & monitoring systems
- Tracking systems
- Wireless security systems
- Automotive electronics
- Industrial electronics
- Ultra Low Power (ULP)

STORAGE CONDITIONS

- Cells should be stored in a clean & dry (less than 30 % RH) area

For updated information please visit our website www.tadiranbat.com

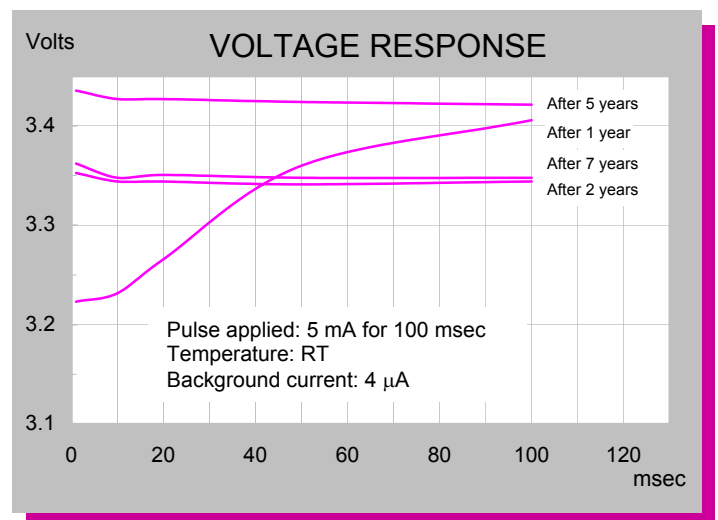
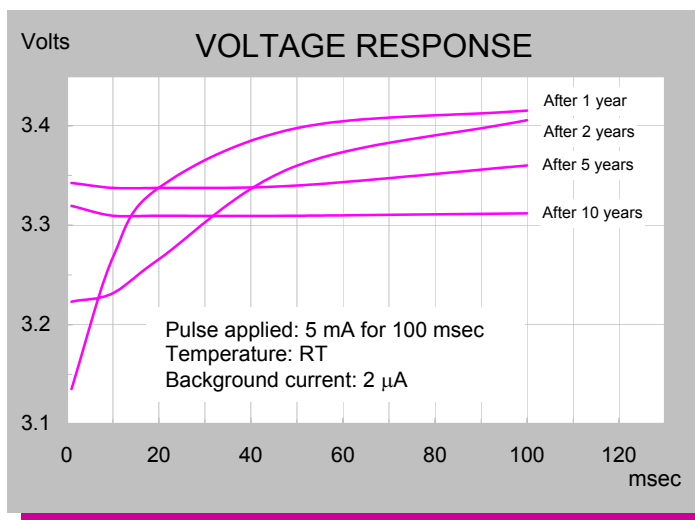

iXtra - Long Term High Performance