



Chipsmall Limited consists of a professional team with an average of over 10 year of expertise in the distribution of electronic components. Based in Hongkong, we have already established firm and mutual-benefit business relationships with customers from,Europe,America and south Asia,supplying obsolete and hard-to-find components to meet their specific needs.

With the principle of "Quality Parts,Customers Priority,Honest Operation,and Considerate Service",our business mainly focus on the distribution of electronic components. Line cards we deal with include Microchip,ALPS,ROHM,Xilinx,Pulse,ON,Everlight and Freescale. Main products comprise IC,Modules,Potentiometer,IC Socket,Relay,Connector.Our parts cover such applications as commercial,industrial, and automotives areas.

We are looking forward to setting up business relationship with you and hope to provide you with the best service and solution. Let us make a better world for our industry!



Contact us

Tel: +86-755-8981 8866 Fax: +86-755-8427 6832

Email & Skype: info@chipsmall.com Web: www.chipsmall.com

Address: A1208, Overseas Decoration Building, #122 Zhenhua RD., Futian, Shenzhen, China



TLE4208G

Quad Half-Bridge Driver IC

Data Sheet

Rev. 1.4, 2016-02-02

Automotive Power

Table of Contents

1	Overview	3
2	Block Diagram	4
3	Pin Configuration	6
3.1	Pin Assignment	6
3.2	Pin Definitions and Functions	6
4	General Product Characteristics	8
4.1	Absolute Maximum Ratings	8
4.2	Functional Range	9
4.3	General Electrical Characteristics	10
4.3.1	Electrical Characteristics	10
5	Application Information	12
6	Package Outlines	14
7	Revision History	15



1 Overview

Features

- Driver for up to 3 motors
- Delivers up to 0.8 A continuous
- Optimized for DC motor management applications
- Very low current consumption in stand-by (Inhibit) mode
- Low saturation voltage; typ. 1.2 V total @ 25 °C; 0.4 A
- Output protected against short circuit
- Error flag diagnosis
- Overvoltage lockout and diagnosis
- Undervoltage lockout
- CMOS/TTL compatible inputs with hysteresis
- No crossover current
- Internal clamp diodes
- Overtemperature protection with hysteresis and diagnosis
- Enhanced power DSO-Package
- Green Product (RoHS compliant)
- AEC Qualified



PG-DSO-28

Description

The TLE4208G is a protected Quad-Half-Bridge-Driver designed specially for automotive and industrial motion control applications. The part is built using Infineons bipolar high voltage power technology DOPL.

In a cascade configuration up to three actuators (DC motors) can be connected between the four half-bridges. These four half-bridges are configured as 2 dual-half-bridges, which are supplied and controlled separately. Operation modes forward (cw), reverse (ccw), brake and high impedance are invoked from a standard interface.

The standard enhanced power PG-DSO-28 package meets the application requirements and saves PCB-board space and costs. Moreover the package is RoHS compliant.

Furthermore the built-in features like diagnosis, over- and undervoltage-lockout, short-circuit protection, over-temperature protection and the very low quiescent current in stand-by mode will open a wide range of automotive and industrial applications.

Type	Package	Marking
TLE4208G	PG-DSO-28	TLE4208G

2 Block Diagram

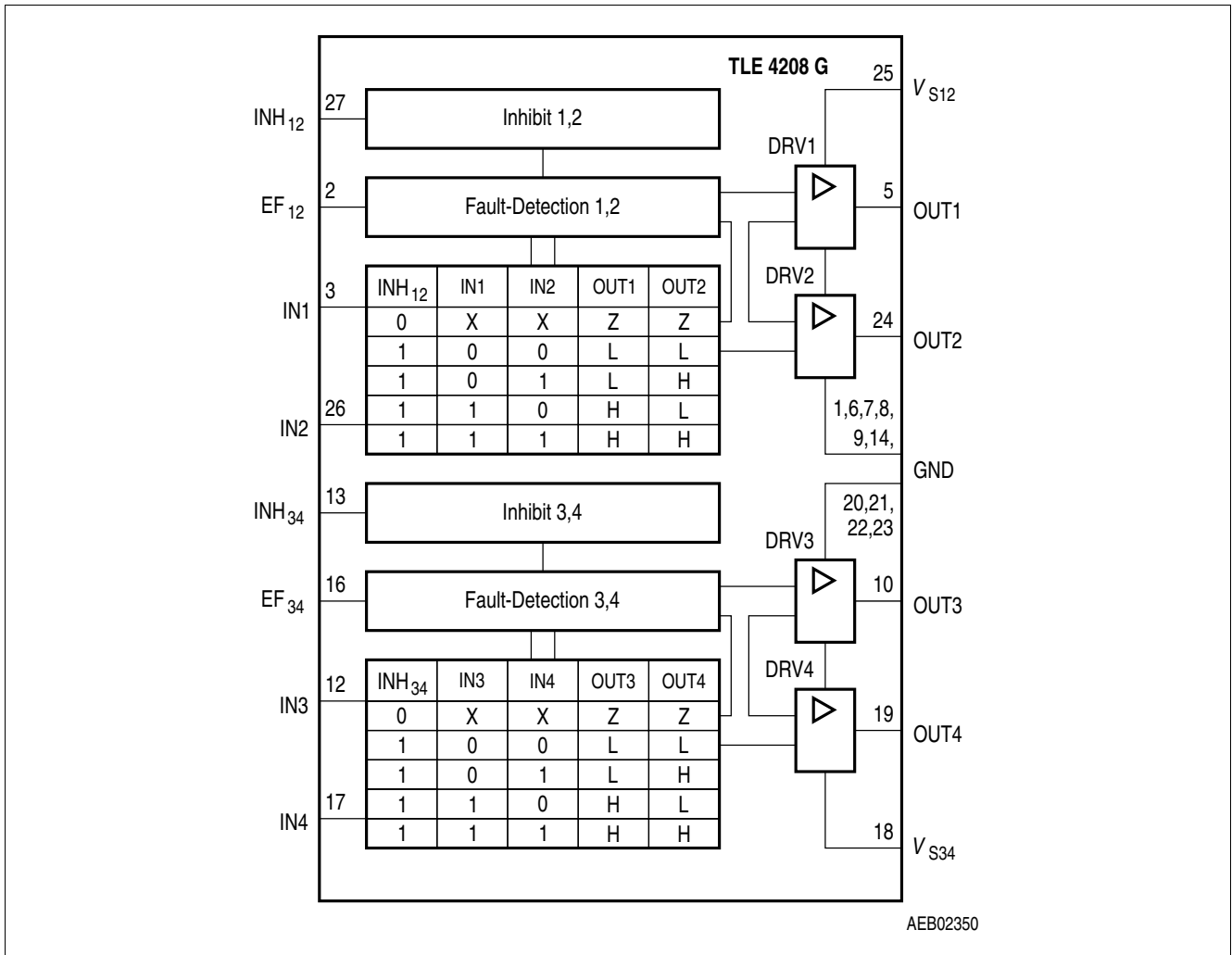

Figure 1 Block Diagram

Input Logic

Table 1 Functional Truth Table of Halfbridge 1 and 2

INH ₁₂	IN1	IN2	OUT1	OUT2	MODE
0	X	X	Z	Z	Stand-by
1	0	0	L	L	Brake LL
1	0	1	L	H	CW
1	1	0	H	L	CCW
1	1	1	H	H	Brake HH

Note: Half-Bridge 1 and 2 connected to a full-bridge

Table 2 **Functional Truth Table of Halfbridge 3 and 4**

INH ₃₄	IN3	IN4	OUT3	OUT4	MODE
0	X	X	Z	Z	Stand-by
1	0	0	L	L	Brake LL
1	0	1	L	H	CW
1	1	0	H	L	CCW
1	1	1	H	H	Brake HH

IN:

0 = Logic LOW

1 = Logic HIGH

X = Don't Care

OUT:

Z = Output in tristate condition

L = Output in sink condition

X = Output in source condition

Note: Half-Bridge 3 and 4 connected to a full-bridge

Table 3 **Diagnosis**

EF ₁₂	EF ₃₄	Error
1	1	no error
0	1	over temperature of half-bridge 1 and 2 OR
0	1	over voltage of half-bridge 1 and 2
1	0	over temperature of half-bridge 3 and 4 OR
1	0	over voltage of half-bridge 3 and 4
0	0	over temperature of all half-bridges OR
0	0	over voltage of all half-bridge

3 Pin Configuration

3.1 Pin Assignment

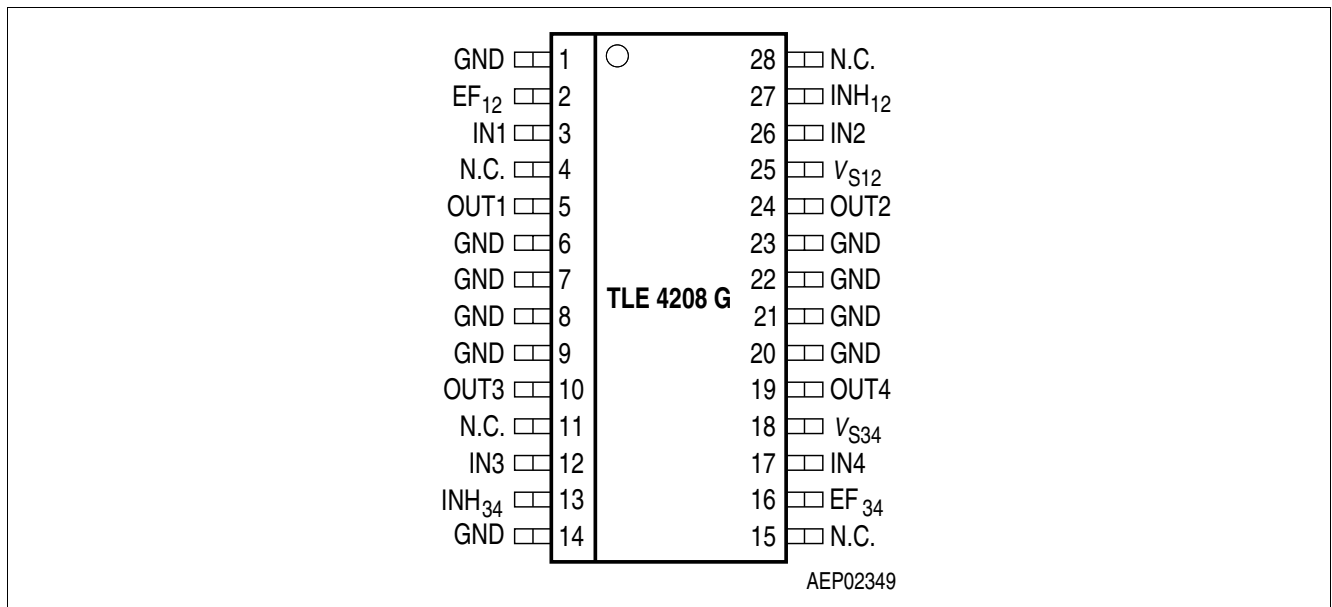

Figure 2 Pin Configuration

3.2 Pin Definitions and Functions

Pin	Symbol	Function
1, 6, 7, 8, 9, 14, 20, 21, 22, 23	GND	Ground ; negative reference potential for blocking capacitor
2	EF ₁₂	Error Flag output of half-bridges 1 and 2 ; open collector; low = error
3	IN1	Input channel of half-bridge 1 ; controls OUT 1
4, 11, 15, 28	N.C.	Not Connected
5	OUT 1	Power output of half-bridge 1 ; short circuit protected; with integrated clamp diodes
10	OUT 3	Power output of half-bridge 3 ; short circuit protected; with integrated clamp diodes
12	IN3	Input channel of half-bridge 3 ; controls OUT 3
13	INH ₃₄	Inhibit input of half-bridges 3 and 4 ; low = half-bridges 3 and 4 in stand-by

Pin Configuration

Pin	Symbol	Function
16	EF ₃₄	Error Flag output of half-bridges 3 and 4; open collector; low = error
17	IN4	Input channel of half-bridge 4; controls OUT 4
18	V _{S34}	Power supply voltage of half-bridges 3 and 4; positive reference potential for blocking capacitor
19	OUT 4	Power output of half-bridge 4; short circuit protected; with integrated clamp diodes
24	OUT 2	Power-output of half-bridge 2; short circuit protected; with integrated clamp diodes
25	V _{S12}	Power supply voltage of half-bridges 1 and 2; positive reference potential for blocking capacitor
26	IN4	Input channel of half-bridge 4; controls OUT 2
27	INH ₁₂	Inhibit input of half-bridges 1 and 2; low = half-bridges 1 and 2 in stand-by

4 General Product Characteristics

4.1 Absolute Maximum Ratings

Table 4 Absolute Maximum Ratings

$T_j = -40^\circ\text{C}$ to $+150^\circ\text{C}$; all voltages with respect to ground, positive current flowing into pin (unless otherwise specified)

Parameter	Symbol	Values			Unit	Note / Test Condition
		Min.	Typ.	Max.		
Voltages						
Supply Voltage	V_{S12}, V_{S34}	-0.3	–	45	V	–
Supply Voltage	V_{S12}, V_{S34}	-1	–	–	V	$t < 0.5\text{s}$; $I_{S12}, I_{S34} > -2\text{A}$
Logic input voltages (IN1; IN2; INH ₁₂ ; IN3; IN4; INH ₃₄)	V_I	-5	–	20	V	$0\text{V} < V_{S12}, V_{S34} < 45\text{V}$
Logic output voltage (EF ₁₂ ; EF ₃₄)	V_{EF12}, V_{EF34}	-0.3	–	20	V	$0\text{V} < V_{S12}, V_{S34} < 45\text{V}$
Currents						
Output Current (cont.)	I_{OUT1-4}	–	–	–	A	internally limited
Output Current (peak)	I_{OUT1-4}	–	–	–	A	internally limited
Output Current (diode)	I_{OUT1-4}	-1	–	1	A	–
Output Current (EF)	$I_{EF12-34}$	-2	–	5	mA	–
Temperatures						
Junction Temperature	T_j	-40	–	150	°C	–
Storage Temperature	T_{stg}	-50	–	150	°C	–
Thermal Resistances						
Junction pin	$R_{thj-pin}$	–	–	25	K/W	measured to pin 7
Junction ambient	R_{thjA}	–	–	65	kV	–

Notes

1. Stresses above the ones listed here may cause permanent damage to the device. Exposure to absolute maximum rating conditions for extended periods may affect device reliability.
2. Integrated protection functions are designed to prevent IC destruction under fault conditions described in the data sheet. Fault conditions are considered as “outside” normal operating range. Protection functions are not designed for continuous repetitive operation.

4.2 Functional Range

Table 5 Functional Range

Parameter	Symbol	Values			Unit	Note / Test Condition
		Min.	Typ.	Max.		
Supply Voltage	V_{S12}, V_{S34}	V_{UV_OFF}	–	18	V	After V_{S12}, V_{S34} rising above V_{UV_ON}
Extended Supply Voltage Range for Operation	V_{S12}, V_{S34}	-0.3	–	V_{UV_ON}	V	Outputs in tristate
Supply Voltage transients slew rate	V_{S12}, V_{S34}	-0.3	–	V_{UV_OFF}	V/ μ s	Outputs in tristate
Logic input voltages (IN1; IN2; INH12; IN3; IN4; INH34)	V_I	-2	–	18	V	–
Junction Temperature	T_j	-40	–	150	°C	–

Note: Within the functional or operating range, the IC operates as described in the circuit description. The electrical characteristics are specified within the conditions given in the Electrical Characteristics table.

4.3 General Electrical Characteristics

4.3.1 Electrical Characteristics

Table 6 Electrical Characteristics

$V_{S12} = V_{S34} = 8\text{ V to }18\text{ V}$, $INH_{12} = INH_{34} = \text{HIGH}$; $I_{OUT1-4} = 0\text{ A}$; $T_j = -40^\circ\text{C to }+150^\circ\text{C}$, all voltages with respect to ground, positive current flowing into pin (unless otherwise specified)

Parameter	Symbol	Values			Unit	Note / Test Condition
		Min.	Typ.	Max.		
Current Consumption						
$INH_{12} = INH_{34} = \text{LOW}$						
Quiescent current	I_S	–	–	100	μA	$I_S = I_{S12} + I_{S34}$
Quiescent current	I_S	–	20	40	μA	$I_S = I_{S12} + I_{S34}$; $V_{S12} = V_{S34} = 13.2\text{ V}$; $T_j = 25^\circ\text{C}$
$INH_{12} = \text{HIGH}$ and $INH_{34} = \text{LOW}$ or $INH_{12} = \text{LOW}$ and $INH_{34} = \text{HIGH}$						
Supply current	I_{S12}, I_{S34}	–	10	20	mA	–
Supply current	I_{S12}, I_{S34}	–	–	30	mA	$I_{OUT1/3} = 0.4\text{ A}$ $I_{OUT2/4} = -0.4\text{ A}$
Supply current	I_{S12}, I_{S34}	–	–	50	mA	$I_{OUT1/3} = 0.8\text{ A}$ $I_{OUT2/4} = -0.8\text{ A}$
Over- and Under Voltage Lockout						
UV Switch ON voltage	$V_{UV\text{ ON}}$	–	6.5	7.5	V	V_{S12}, V_{S34} increasing
UV Switch OFF voltage	$V_{UV\text{ OFF}}$	5	6	–	V	V_{S12}, V_{S34} decreasing
UV ON/ OFF hysteresis	$V_{UV\text{ HY}}$	–	0.5	–	V	$V_{UV\text{ ON}} - V_{UV\text{ OFF}}$
OV Switch OFF voltage	$V_{OV\text{ OFF}}$	–	20	24	V	V_{S12}, V_{S34} increasing
OV Switch ON voltage	$V_{OV\text{ ON}}$	18	19.5	–	V	V_{S12}, V_{S34} decreasing
OV ON/ OFF hysteresis	$V_{OV\text{ HY}}$	–	0.5	–	V	$V_{OV\text{ OFF}} - V_{OV\text{ ON}}$
Outputs OUT1; OUT2; OUT3; OUT4						
Saturation Voltages						
Source (upper) $I_{OUT12}, I_{OUT34} = -0.2\text{ A}$	V_{SAT_U}	–	0.85	1.15	V	$T_j = 25^\circ\text{C}$
Source (upper) $I_{OUT12}, I_{OUT34} = -0.4\text{ A}$	V_{SAT_U}	–	0.90	1.20	V	$T_j = 25^\circ\text{C}$
Sink (upper) $I_{OUT12}, I_{OUT34} = -0.8\text{ A}$	V_{SAT_U}	–	1.10	1.50	V	$T_j = 25^\circ\text{C}$
Sink (lower) $I_{OUT12}, I_{OUT34} = 0.2\text{ A}$	V_{SAT_L}	–	0.15	0.23	V	$T_j = 25^\circ\text{C}$
Sink (lower) $I_{OUT12}, I_{OUT34} = 0.4\text{ A}$	V_{SAT_L}	–	0.25	0.40	V	$T_j = 25^\circ\text{C}$
Sink (lower) $I_{OUT12}, I_{OUT34} = 0.8\text{ A}$	V_{SAT_L}	–	0.45	0.75	V	$T_j = 25^\circ\text{C}$
Total Drop $I_{OUT12}, I_{OUT34} = 0.2\text{ A}$	V_{SAT}	–	1	1.4	V	$V_{SAT} = V_{SAT_U} + V_{SAT_L}$

Table 6 Electrical Characteristics
 $V_{S12} = V_{S34} = 8\text{ V to }18\text{ V}$, $INH_{12} = INH_{34} = \text{HIGH}$; $I_{OUT1-4} = 0\text{ A}$; $T_j = -40^\circ\text{C to }+150^\circ\text{C}$, all voltages with respect to ground, positive current flowing into pin (unless otherwise specified)

Parameter	Symbol	Values			Unit	Note / Test Condition
		Min.	Typ.	Max.		
Total Drop $I_{OUT12}, I_{OUT34} = 0.4\text{ A}$	V_{SAT}	–	1.2	1.7	V	$V_{SAT} = V_{SAT_U} + V_{SAT_L}$
Total Drop $I_{OUT12}, I_{OUT34} = 0.8\text{ A}$	V_{SAT}	–	1.6	2.5	V	$V_{SAT} = V_{SAT_U} + V_{SAT_L}$
Clamp Diodes						
Forward voltage; upper	V_{FU}	–	1	1.5	V	$I_F = 0.4\text{ A}$
Upper leakage current	I_{LKU}	–	–	5	mA	$I_F = 0.4\text{ A}^{1)}$
Forward voltage; lower	V_{FL}	–	0.9	1.4	V	$I_F = 0.4\text{ A}$
Input Interface						
Logic Inputs IN1; IN2; IN3; IN4						
H-input voltage	V_{IH}	–	2.0	3.0	V	–
L-input voltage	V_{IL}	1.0	1.5	–	V	–
Hysteresis of input voltage	V_{IHY}	–	0.5	–	V	–
H-input current	I_{IH}	-2	–	10	μA	$V_I = 5\text{ V}$
L-input current	I_{IL}	-100	-20	-5	μA	$V_I = 0\text{ V}$
Logic Inputs INH₁₂; INH₃₄						
H-input voltage	V_{IH}	–	2.7	3.5	V	–
L-input voltage	V_{IL}	1.0	2.0	–	V	–
Hysteresis of input voltage	V_{IHY}	–	0.7	–	V	–
H-input current	I_{IH}	–	100	250	μA	$V_{INH} = 5\text{ V}$
L-input current	I_{IL}	-10	–	10	μA	$V_{INH} = 0\text{ V}$
Error Flags EF₁₂; EF₃₄						
L-output voltage level	V_{EFL}	–	0.2	0.4	V	$I_{EF} = 2\text{ mA}$
Leakage current	I_{EFLK}	–	–	10	μA	$0\text{ V} < V_{EF} < 7\text{ V}$
Thermal Shutdown						
Thermal shutdown junction temperature	T_{jSD}	150	175	200	$^\circ\text{C}$	–
Thermal switch-on junction temperature	T_{jSO}	120	–	170	$^\circ\text{C}$	–
Temperature hysteresis	ΔT	–	30	–	K	–

1) Not subject to production test, specified by design

5 Application Information

Note: The following information is given as a hint for the implementation of the device only and shall not be regarded as a description or warranty of a certain functionality, condition or quality of the device.

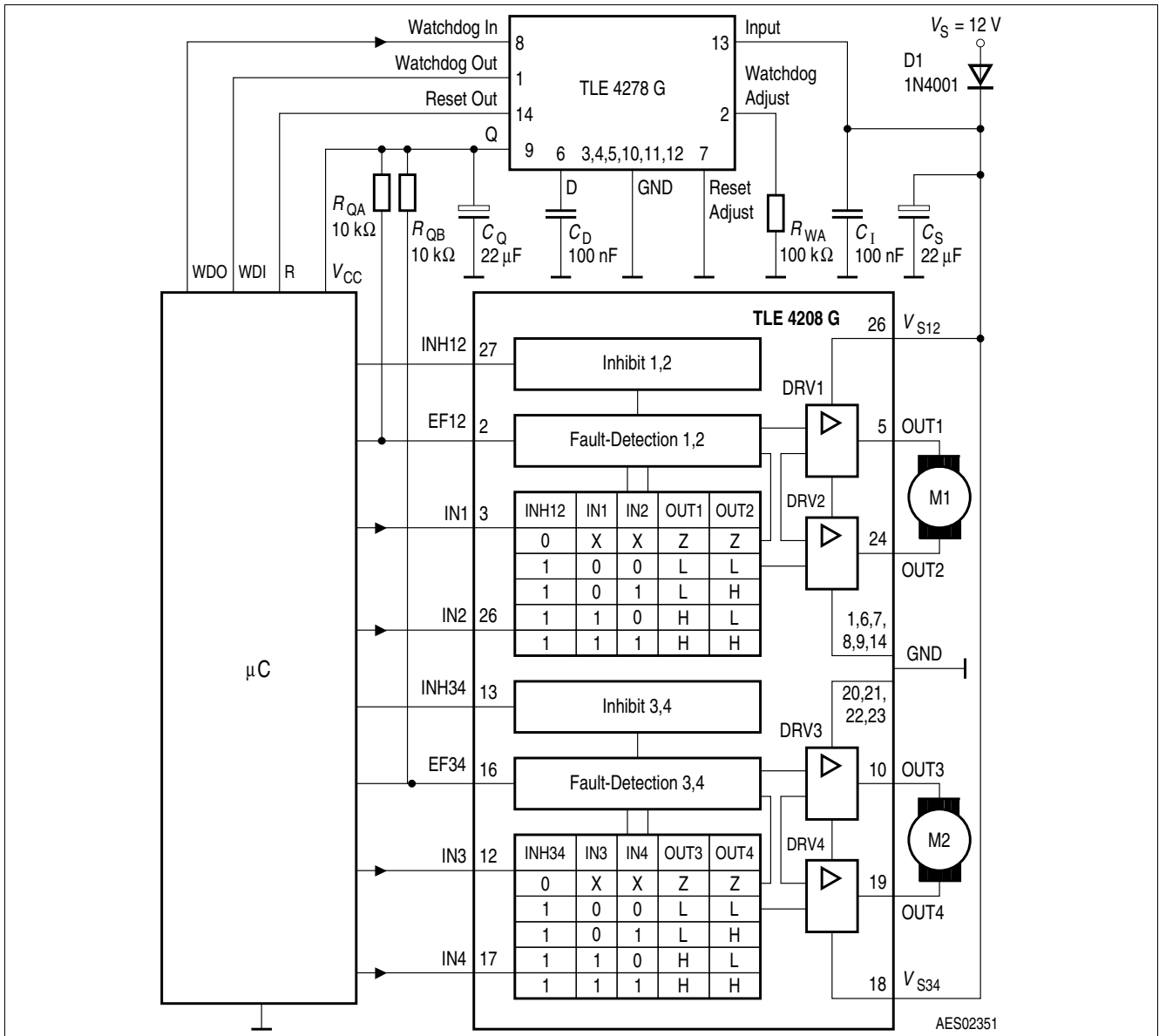
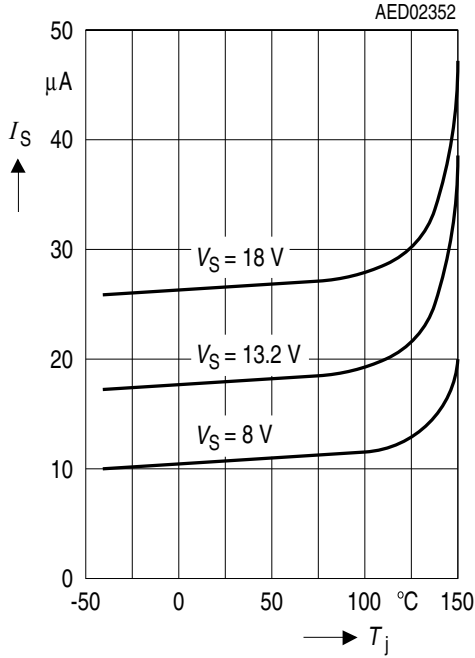

Figure 3 Application Circuit 1 (Device is used as Dual-Full-Bridge-Driver)

Note: This is a very simplified example of an application circuit. The function must be verified in the real application.

Diagrams

Quiescent current I_S over Temperature



Saturation Voltage of Source $V_{SAT U}$ over Temperature

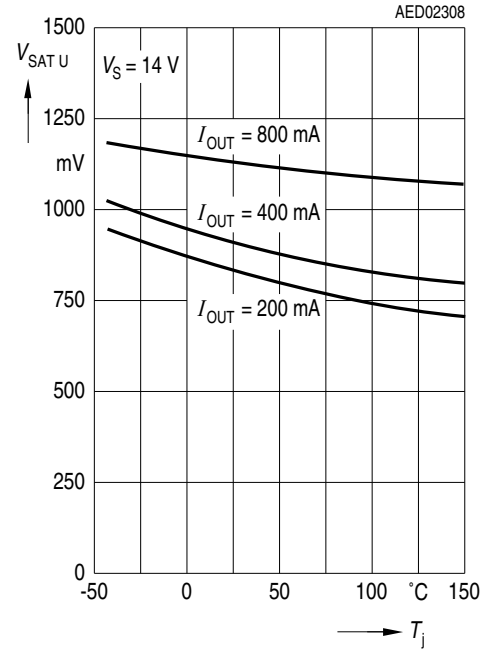

Saturation Voltage of Sink $V_{SAT L}$ over Temperature

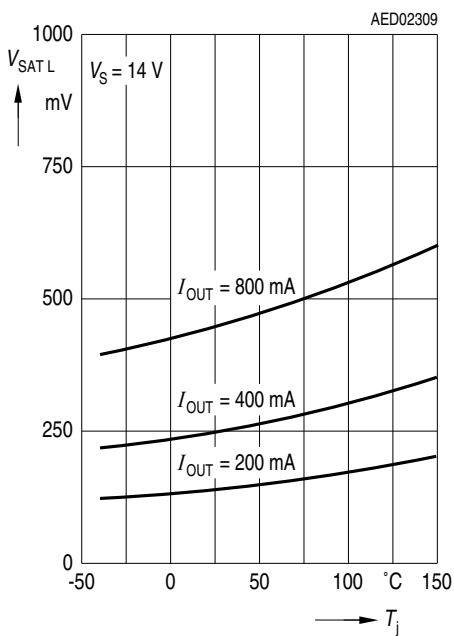

Total Drop at outputs V_{SAT} over Temperature

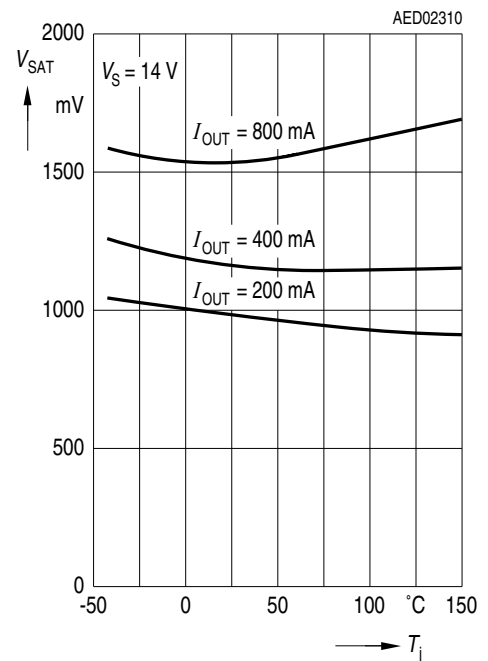

6 Package Outlines

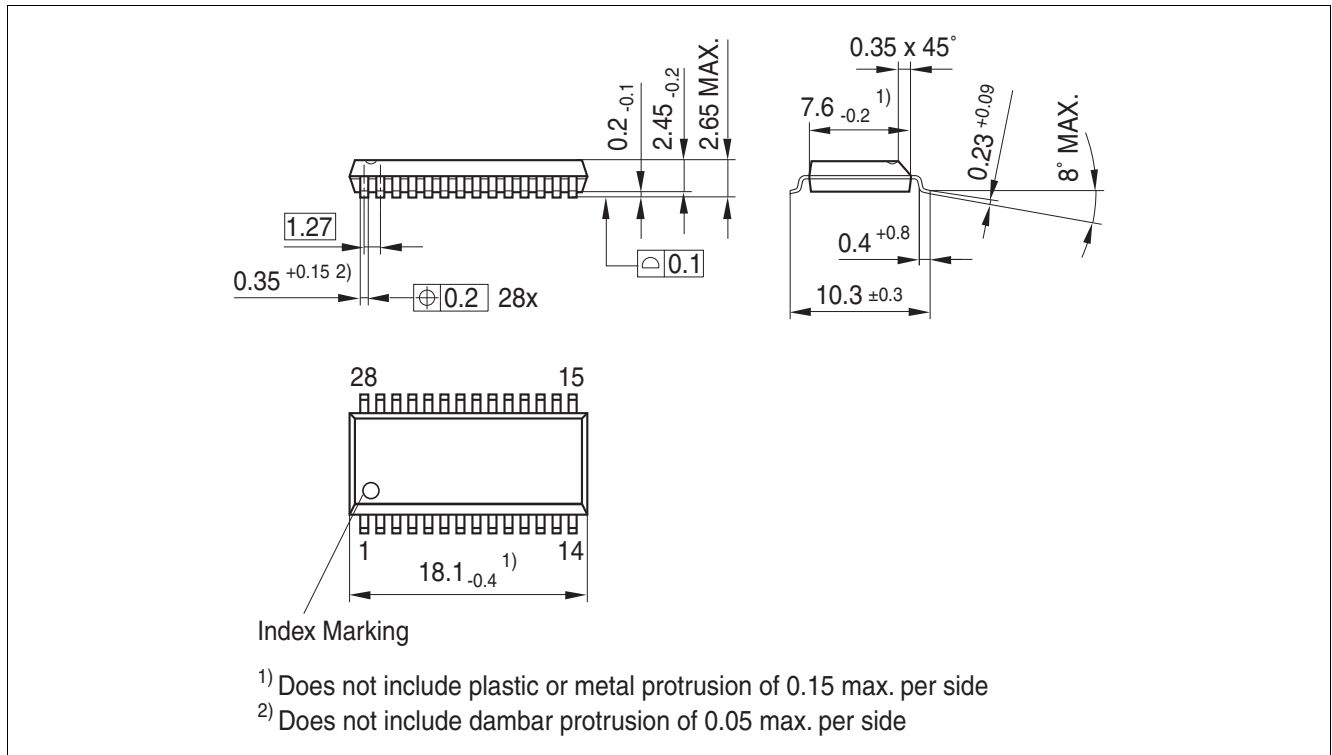

Figure 4 PG-DSO-28

Green Product (RoHS compliant)

To meet the world-wide customer requirements for environmentally friendly products and to be compliant with government regulations the device is available as a green product. Green products are RoHS-Compliant (i.e Pb-free finish on leads and suitable for Pb-free soldering according to IPC/JEDEC J-STD-020).

7 Revision History

Revision	Date	Changes
Rev. 1.4	2016-02-02	Correction of typographical errors Page 10: VOFF_OFF and VOFF_ON are inverted. No change of the device behavior. Page 10,11: VS1, respectively VS2, renamed VS12 and VS34
Rev. 1.3	2014-02-12	Updated package designation and to latest data sheet formatting
Rev. 1.2	2011-04-11	Updated package designation to reflect various production sites.
Rev. 1.1	2008-02-04	Initial version of RoHS-compliant derivate of TLE4208G Page 1: added AEC certified statement Page 1 and 13: added RoHS compliance statement and Green product feature Page 1 and 3: Editorial change: deleted "fully" (The term "fully protected" often leads to misunderstandings as it is unclear with respect to which parameters). Page 1 and 14: Package changed to RoHS compliant version Page 15: added Revision History, updated Legal Disclaimer

Edition 2016-02-02

**Published by
Infineon Technologies AG
81726 Munich, Germany**

**© 2016 Infineon Technologies AG
All Rights Reserved.**

Legal Disclaimer

The information given in this document shall in no event be regarded as a guarantee of conditions or characteristics. With respect to any examples or hints given herein, any typical values stated herein and/or any information regarding the application of the device, Infineon Technologies hereby disclaims any and all warranties and liabilities of any kind, including without limitation, warranties of non-infringement of intellectual property rights of any third party.

Information

For further information on technology, delivery terms and conditions and prices, please contact the nearest Infineon Technologies Office (www.infineon.com).

Warnings

Due to technical requirements, components may contain dangerous substances. For information on the types in question, please contact the nearest Infineon Technologies Office.

Infineon Technologies components may be used in life-support devices or systems only with the express written approval of Infineon Technologies, if a failure of such components can reasonably be expected to cause the failure of that life-support device or system or to affect the safety or effectiveness of that device or system. Life support devices or systems are intended to be implanted in the human body or to support and/or maintain and sustain and/or protect human life. If they fail, it is reasonable to assume that the health of the user or other persons may be endangered.