



Chipsmall Limited consists of a professional team with an average of over 10 year of expertise in the distribution of electronic components. Based in Hongkong, we have already established firm and mutual-benefit business relationships with customers from,Europe,America and south Asia,supplying obsolete and hard-to-find components to meet their specific needs.

With the principle of "Quality Parts,Customers Priority,Honest Operation,and Considerate Service",our business mainly focus on the distribution of electronic components. Line cards we deal with include Microchip,ALPS,ROHM,Xilinx,Pulse,ON,Everlight and Freescale. Main products comprise IC,Modules,Potentiometer,IC Socket,Relay,Connector.Our parts cover such applications as commercial,industrial, and automotives areas.

We are looking forward to setting up business relationship with you and hope to provide you with the best service and solution. Let us make a better world for our industry!



## Contact us

Tel: +86-755-8981 8866 Fax: +86-755-8427 6832

Email & Skype: info@chipsmall.com Web: www.chipsmall.com

Address: A1208, Overseas Decoration Building, #122 Zhenhua RD., Futian, Shenzhen, China



# TLE4961-2M

High Precision Automotive Hall Effect Latch

## Data Sheet

Revision 1.0, 2013-01-19

**Edition 2013-01-19**

**Published by  
Infineon Technologies AG  
81726 Munich, Germany**

**© 2013 Infineon Technologies AG  
All Rights Reserved.**

### **Legal Disclaimer**

The information given in this document shall in no event be regarded as a guarantee of conditions or characteristics. With respect to any examples or hints given herein, any typical values stated herein and/or any information regarding the application of the device, Infineon Technologies hereby disclaims any and all warranties and liabilities of any kind, including without limitation, warranties of non-infringement of intellectual property rights of any third party.

### **Information**

For further information on technology, delivery terms and conditions and prices, please contact the nearest Infineon Technologies Office ([www.infineon.com](http://www.infineon.com)).

### **Warnings**

Due to technical requirements, components may contain dangerous substances. For information on the types in question, please contact the nearest Infineon Technologies Office.

Infineon Technologies components may be used in life-support devices or systems only with the express written approval of Infineon Technologies, if a failure of such components can reasonably be expected to cause the failure of that life-support device or system or to affect the safety or effectiveness of that device or system. Life support devices or systems are intended to be implanted in the human body or to support and/or maintain and sustain and/or protect human life. If they fail, it is reasonable to assume that the health of the user or other persons may be endangered.

**Revision History**

Page or Item	Subjects (major changes since previous revision)
<b>Revision 1.0, 2013-01-19</b>	
15	Bhys values corrected

**Trademarks of Infineon Technologies AG**

AURIX™, C166™, CanPAK™, CIPOS™, CIPURSE™, EconoPACK™, CoolMOS™, CoolSET™, CORECONTROL™, CROSSAVE™, DAVE™, EasyPIM™, EconoBRIDGE™, EconoDUAL™, EconoPIM™, EiceDRIVER™, eupec™, FCOS™, HITFET™, HybridPACK™, I<sup>2</sup>RF™, ISOFACE™, IsoPACK™, MIPAQ™, ModSTACK™, my-d™, NovalithIC™, OptiMOS™, ORIGA™, PRIMARION™, PrimePACK™, PrimeSTACK™, PRO-SIL™, PROFET™, RASIC™, ReverSave™, SatRIC™, SIEGET™, SINDRION™, SIPMOS™, SmartLEWIS™, SOLID FLASH™, TEMPFET™, thinQ!™, TRENCHSTOP™, TriCore™.

**Other Trademarks**

Advance Design System™ (ADS) of Agilent Technologies, AMBA™, ARM™, MULTI-ICE™, KEIL™, PRIMECELL™, REALVIEW™, THUMB™, μVision™ of ARM Limited, UK. AUTOSAR™ is licensed by AUTOSAR development partnership. Bluetooth™ of Bluetooth SIG Inc. CAT-iq™ of DECT Forum. COLOSSUS™, FirstGPS™ of Trimble Navigation Ltd. EMV™ of EMVCo, LLC (Visa Holdings Inc.). EPCOS™ of Epcos AG. FLEXGO™ of Microsoft Corporation. FlexRay™ is licensed by FlexRay Consortium. HYPERTERMINAL™ of Hilgraeve Incorporated. IEC™ of Commission Electrotechnique Internationale. IrDA™ of Infrared Data Association Corporation. ISO™ of INTERNATIONAL ORGANIZATION FOR STANDARDIZATION. MATLAB™ of MathWorks, Inc. MAXIM™ of Maxim Integrated Products, Inc. MICROTEC™, NUCLEUS™ of Mentor Graphics Corporation. Mifare™ of NXP. MIPI™ of MIPI Alliance, Inc. MIPS™ of MIPS Technologies, Inc., USA. muRata™ of MURATA MANUFACTURING CO., MICROWAVE OFFICE™ (MWO) of Applied Wave Research Inc., OmniVision™ of OmniVision Technologies, Inc. Openwave™ Openwave Systems Inc. RED HAT™ Red Hat, Inc. RFMD™ RF Micro Devices, Inc. SIRIUS™ of Sirius Satellite Radio Inc. SOLARIS™ of Sun Microsystems, Inc. SPANSION™ of Spansion LLC Ltd. Symbian™ of Symbian Software Limited. TAIYO YUDEN™ of Taiyo Yuden Co. TEAKLITE™ of CEVA, Inc. TEKTRONIX™ of Tektronix Inc. TOKO™ of TOKO KABUSHIKI KAISHA TA. UNIX™ of X/Open Company Limited. VERILOG™, PALLADIUM™ of Cadence Design Systems, Inc. VLYNQ™ of Texas Instruments Incorporated. VXWORKS™, WIND RIVER™ of WIND RIVER SYSTEMS, INC. ZETEX™ of Diodes Zetex Limited.

Last Trademarks Update 2011-02-24

## Table of Contents

	<b>Table of Contents</b> .....	4
	<b>List of Figures</b> .....	5
	<b>List of Tables</b> .....	6
<b>1</b>	<b>Product Description</b> .....	7
1.1	Overview .....	7
1.2	Features .....	7
1.3	Target Applications .....	7
<b>2</b>	<b>Functional Description</b> .....	8
2.1	General .....	8
2.2	Pin Configuration (top view) .....	8
2.3	Pin Description .....	8
2.4	Block Diagram .....	9
2.5	Functional Block Description .....	9
2.6	Default Start-up Behavior .....	11
<b>3</b>	<b>Specification</b> .....	12
3.1	Application Circuit .....	12
3.2	Absolute Maximum Ratings .....	13
3.3	Operating Range .....	14
3.4	Electrical and Magnetic Characteristics .....	14
3.5	Electro Magnetic Compatibility .....	16
<b>4</b>	<b>Package Information</b> .....	17
4.1	Package Outline PG-SOT23-3-15 .....	17
4.2	Packing Information PG-SOT23-3-15 .....	17
4.3	Footprint PG-SC59-3-5 and PG-SOT23-3-15 .....	18
4.4	PG-SOT23-3-15 Distance between Chip and Package .....	18
4.5	Package Marking .....	18
<b>5</b>	<b>Graphs of the Magnetic Parameters</b> .....	19
<b>6</b>	<b>Graphs of the Electrical Parameters</b> .....	20

**List of Figures**

Figure 1-1	Image of TLE4964-5M in the PG-SOT23-3-15 Package	7
Figure 2-1	Pin Configuration and Center of Sensitive Area	8
Figure 2-2	Functional Block Diagram TLE4964-5M	9
Figure 2-3	Timing Diagram TLE4964-5M	10
Figure 2-4	Output Signal TLE4964-5M	10
Figure 2-5	Illustration of the Start-up Behavior of the TLE4964-5M	11
Figure 3-1	Application Circuit 1: With External Resistor	12
Figure 3-2	Application Circuit 2: Without External Resistor	12
Figure 3-3	Definition of Magnetic Field Direction PG-SOT23-3-15	15
Figure 3-4	EMC Test Circuit	16
Figure 4-1	PG-SOT23-3-15 Package Outline (All Dimensions in mm)	17
Figure 4-2	Packing of the PG-SOT23-3-15 in a Tape	17
Figure 4-3	Footprint PG-SC59-3-5 and PG-SOT23-3-15	18
Figure 4-4	Distance between Chip and Package	18
Figure 4-5	Marking of TLE4964-5M	18
Figure 5-1	Operating Point ( $B_{OP}$ ) of the TLE4964-5M over Temperature	19
Figure 5-2	Release Point ( $B_{RP}$ ) of the TLE4964-5M over Temperature	19
Figure 5-3	Hysteresis ( $B_{Hys}$ ) of the TLE4964-5M over Temperature	19
Figure 6-1	Power On Time $t_{PON}$ of the TLE4964-5M over Temperature	20
Figure 6-2	Signal Delay Time of the TLE4964-5M over Temperature	20
Figure 6-3	Supply Current of the TLE4964-5M over Temperature	21
Figure 6-4	Supply Current of the TLE4964-5M over Supply Voltage	21
Figure 6-5	Output Current Limit of the TLE4964-5M over Temperature	22
Figure 6-6	Output Current Limit of the TLE4964-5M over applied Pull-up Voltage	22
Figure 6-7	Output Fall Time of the TLE4964-5M over Temperature	22
Figure 6-8	Output Fall Time of the TLE4964-5M over applied Pull-up Voltage	23
Figure 6-9	Output Rise Time of the TLE4964-5M over Temperature	23
Figure 6-10	Output Rise Time of the TLE4964-5M over applied Pull-up Voltage	23
Figure 6-11	Output Leakage Current of the TLE4964-5M over Temperature	24
Figure 6-12	Saturation Voltage of the TLE4964-5M over Temperature	24
Figure 6-13	Saturation Voltage of the TLE4964-5M over Output Current	24
Figure 6-14	Effective Noise of the TLE4964-5M Thresholds over Temperature	25
Figure 6-15	Output Signal Jitter of the TLE4964-5M over Temperature	25

## List of Tables

Table 1-1	Ordering Information	7
Table 2-1	Pin Description PG-SOT23-3-15	8
Table 3-1	Absolute Maximum Rating Parameters	13
Table 3-2	ESD Protection (TA = 25°C)	13
Table 3-3	Operating Conditions Parameters	14
Table 3-4	General Electrical Characteristics	14
Table 3-5	Magnetic Characteristics	15
Table 3-6	Magnetic Compatibility	16
Table 3-7	Electro Magnetic Compatibility	16

# 1 Product Description



## 1.1 Overview

Characteristic	Supply Voltage	Supply Current	Sensitivity	Interface	Temperature
Bipolar Hall Effect Latch	3.0~32 V	1.6 mA	High B <sub>OP</sub> :5 mT B <sub>RP</sub> :-5 mT	Open Drain Output	-40°C to 170°C



Figure 1-1 Image of TLE4961-2M in the PG-SOT23-3-15 Package

## 1.2 Features

- 3.0 V to 32 V operating supply voltage
- Operation from unregulated power supply
- Reverse polarity protection (-18 V)
- Overvoltage capability up to 42 V without external resistor
- Output overcurrent & overtemperature protection
- Active error compensation
- High stability of magnetic thresholds
- Low jitter (typ. 0.35 μs)
- High ESD performance
- Small SMD package PG-SOT23-3-15 (TLE4961-2M)

## 1.3 Target Applications

Target applications for the TLE496x Hall switch family are all applications which require a high precision Hall Switch with an operating temperature range from -40°C to 170°C. Its superior supply voltage range from 3.0 V to 32 V with overvoltage capability (e.g. load-dump) up to 42 V without external resistor makes it ideally suited for automotive and industrial applications.

The magnetic behavior as a latch and switching thresholds of typical ±5 mT make the device especially suited for the use with a pole wheel for index counting applications as e.g. power closing and window lifter.

Table 1-1 Ordering Information

Product Name	Product Type	Ordering Code	Package
TLE4961-2M	Hall Latch	SP000997954	PG-SOT23-3-15



## 2 Functional Description

### 2.1 General

The TLE4961-2M is an integrated Hall effect designed specifically for highly accurate applications with superior supply voltage capability, operating temperature range and temperature stability of the magnetic thresholds.

### 2.2 Pin Configuration (top view)

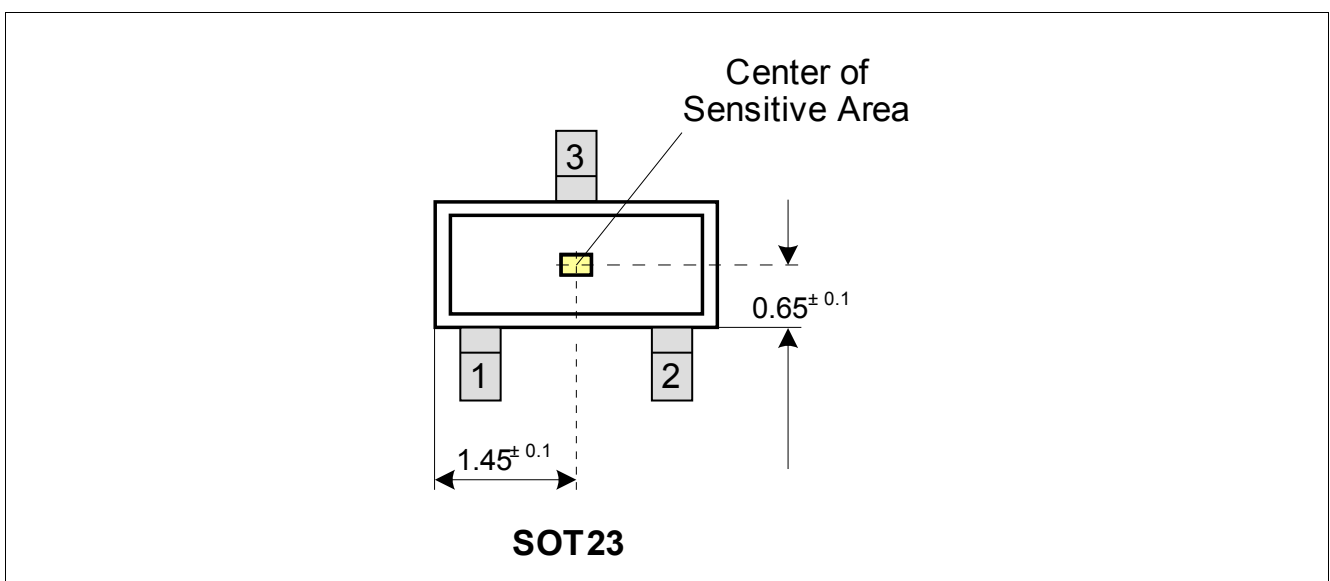

Figure 2-1 Pin Configuration and Center of Sensitive Area

### 2.3 Pin Description

Table 2-1 Pin Description PG-SOT23-3-15

Pin No.	Symbol	Function
1	VDD	Supply voltage
2	Q	Output
3	GND	Ground

## 2.4 Block Diagram

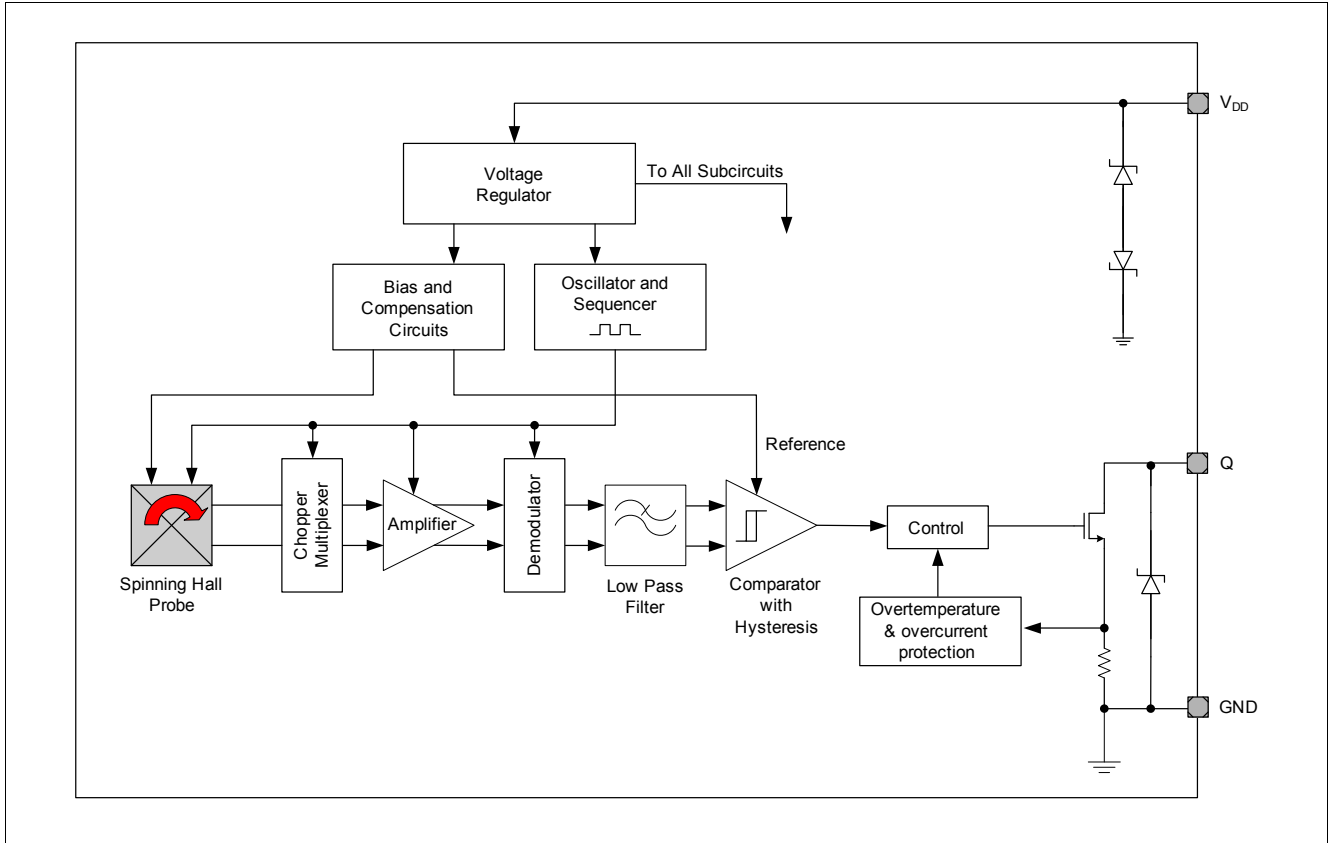

Figure 2-2 Functional Block Diagram TLE4961-2M

## 2.5 Functional Block Description

The chopped Hall IC switch comprises a Hall probe, bias generator, compensation circuits, oscillator and output transistor.

The bias generator provides currents for the Hall probe and the active circuits. Compensation circuits stabilize the temperature behavior and reduce influence of technology variations.

The active error compensation (chopping technique) rejects offsets in the signal path and the influence of mechanical stress to the Hall probe caused by molding and soldering processes and other thermal stress in the package. The chopped measurement principle together with the threshold generator and the comparator ensures highly accurate and temperature stable magnetic thresholds.

The output transistor has an integrated overcurrent and overtemperature protection.

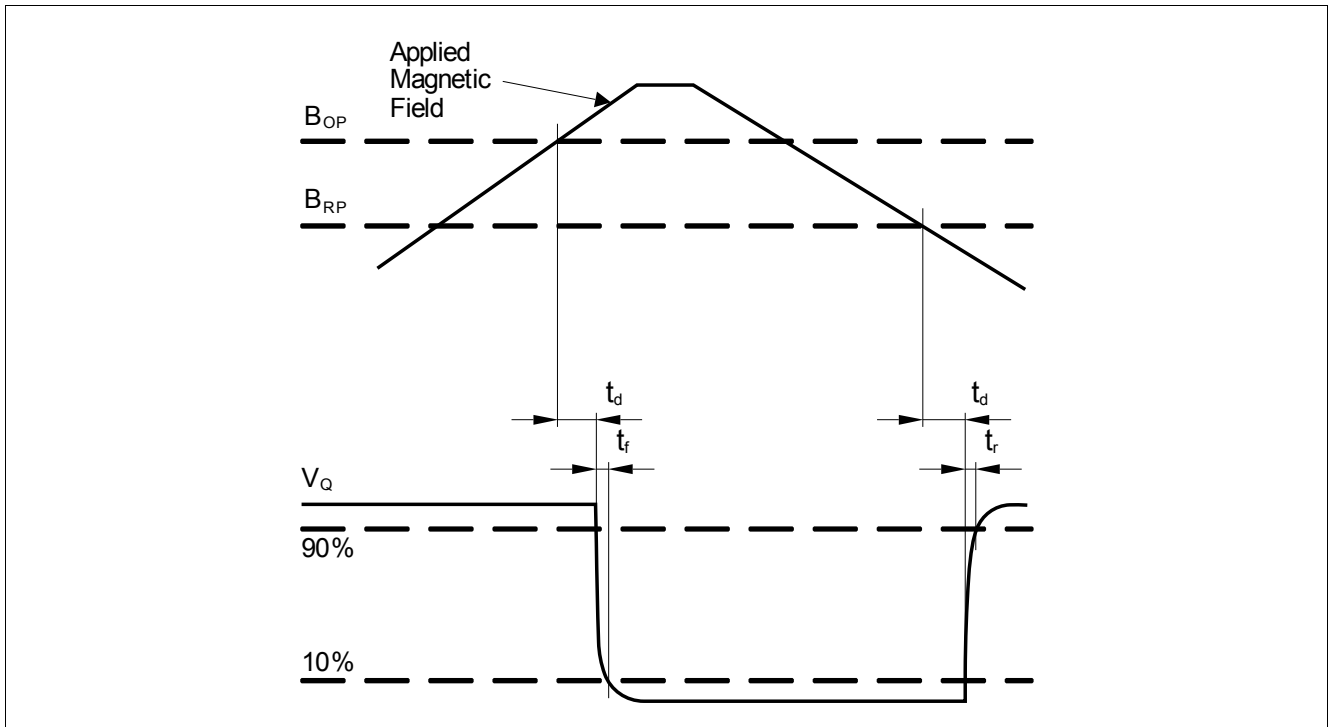

Figure 2-3 Timing Diagram TLE4961-2M

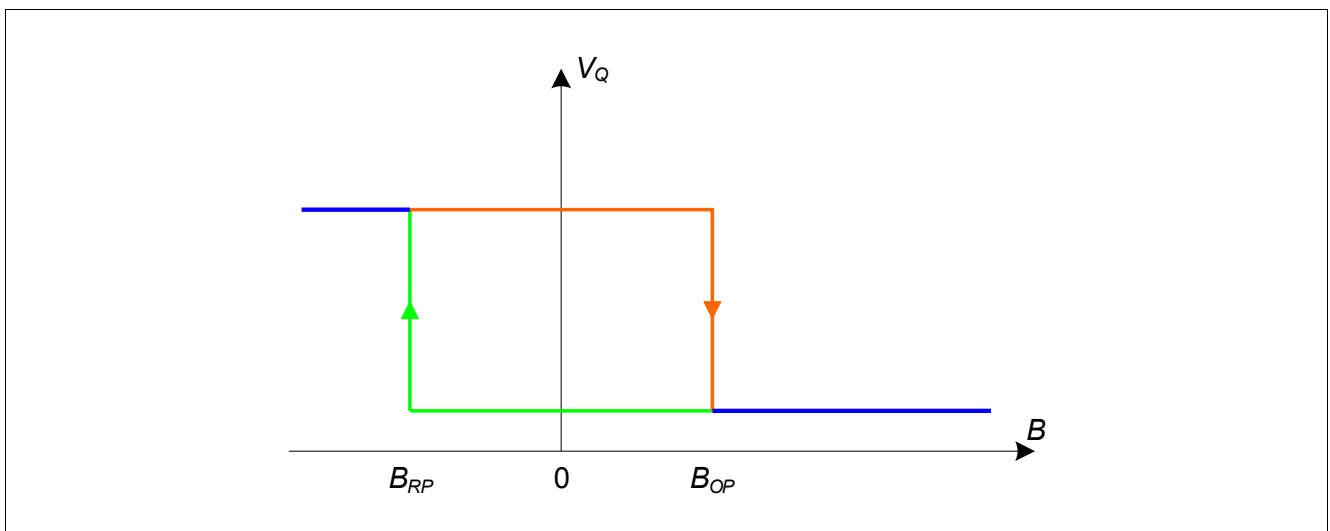

Figure 2-4 Output Signal TLE4961-2M

## 2.6 Default Start-up Behavior

The magnetic thresholds exhibit a hysteresis  $B_{HYS} = B_{OP} - B_{RP}$ . In case of a power-on with a magnetic field  $B$  within hysteresis ( $B_{OP} > B > B_{RP}$ ) the output of the sensor is set to the pull up voltage level ( $V_Q$ ) per default. After the first crossing of  $B_{OP}$  or  $B_{RP}$  of the magnetic field the internal decision logic is set to the corresponding magnetic input value.

$V_{DDA}$  is the internal supply voltage which is following the external supply voltage  $V_{DD}$ .

This means for  $B > B_{OP}$  the output is switching, for  $B < B_{RP}$  and  $B_{OP} > B > B_{RP}$  the output stays at  $V_Q$ .

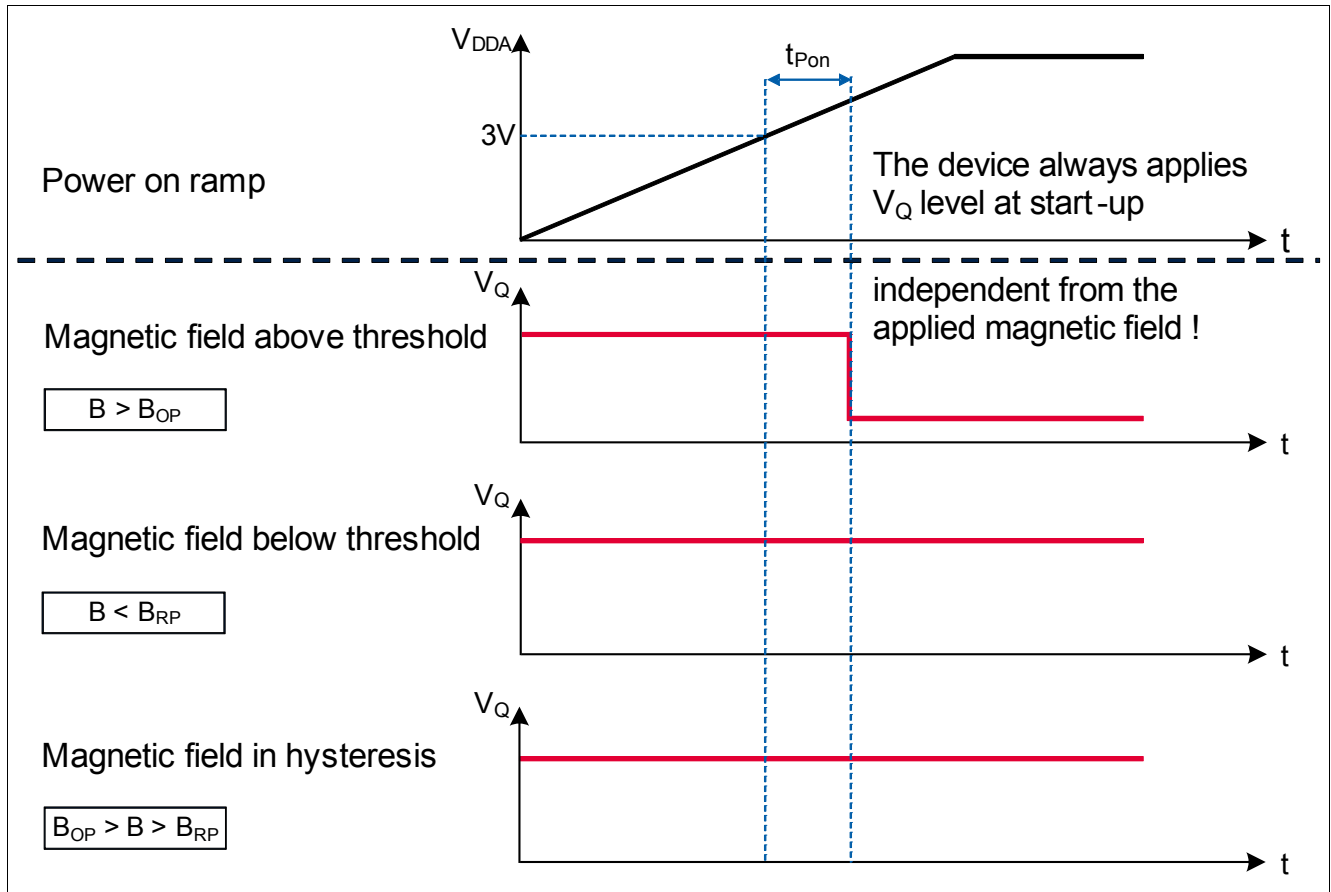

Figure 2-5 Illustration of the Start-up Behavior of the TLE4961-2M

### 3 Specification

#### 3.1 Application Circuit

The following **Figure 3-1** shows the basic option of an application circuit. Only a pull-up resistor  $R_Q$  is necessary. An external series resistor for  $V_S$  is not needed. The resistor  $R_Q$  has to be in a dimension to match the applied  $V_S$  to keep  $I_Q$  limited to the operating range of maximum 25 mA.

e.g.:  $V_S = 12\text{ V}$  and  $R_Q = 1200\ \Omega$  gives  $I_Q = 12\text{ V} / 1200\ \Omega = 10\text{ mA}$ .

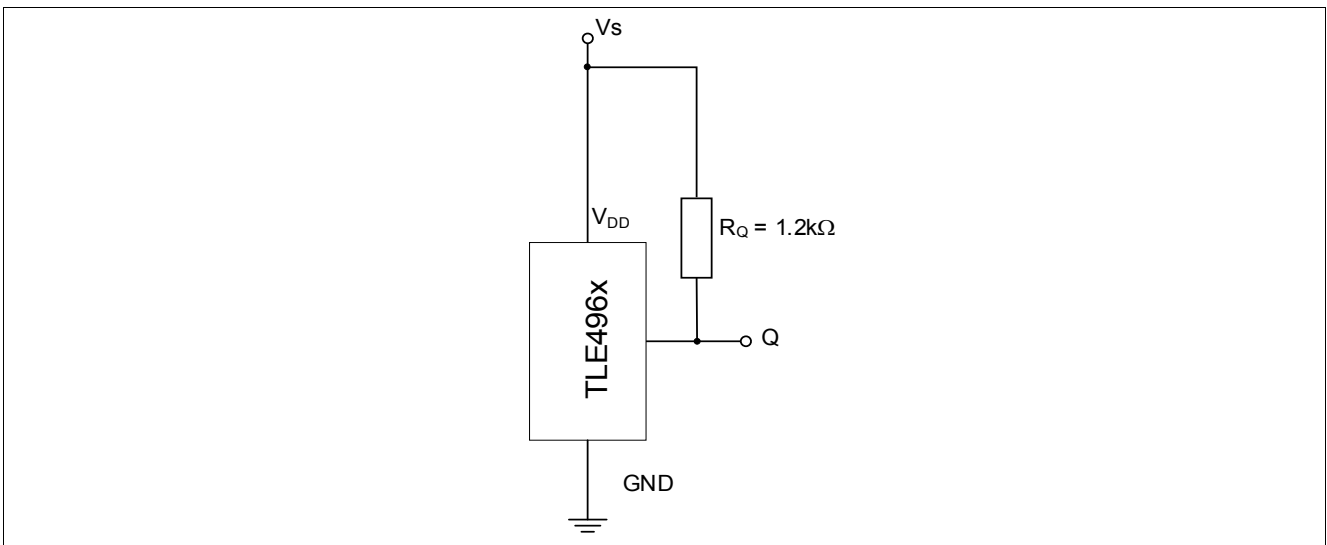

**Figure 3-1 Basic Application Circuit #1: Only Pull-Up Resistor is necessary**

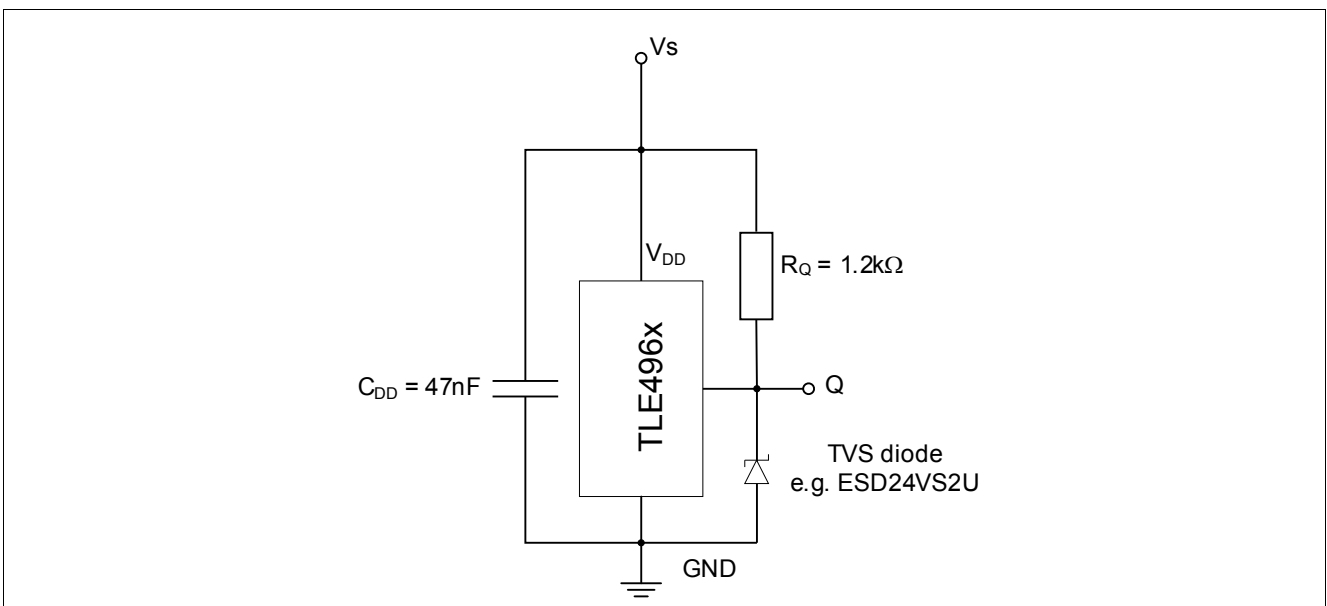

**Figure 3-2 Enhanced Application Circuit #2: for extended ESD robustness**

With an additional capacitor  $C_{DD}$  and a transient voltage suppression (TVS) diode an extended ESD robustness of 15kV on system level is achieved (**Figure 3-2**). If an increased robustness for e.g. testpulse 1 is required a serial resistor in the supply needs to be added (see also **Chapter 3.5**).

### 3.2 Absolute Maximum Ratings

**Table 3-1 Absolute Maximum Rating Parameters**

Parameter	Symbol	Values			Unit	Note / Test Condition
		Min.	Typ.	Max.		
Supply voltage <sup>1)</sup>	V <sub>DD</sub>	-18		32 42	V	10h, no external resistor required
Output voltage	V <sub>Q</sub>	-0.5		32	V	
Reverse output current	I <sub>Q</sub>	-70			mA	
Junction temperature <sup>1)</sup>	T <sub>J</sub>	-40		155 165 175 195	°C	for 2000h (not additive) for 1000h (not additive) for 168h (not additive) for 3 x 1h (additive)
Storage temperature	T <sub>S</sub>	-40		150	°C	
Thermal resistance Junction ambient	R <sub>thJA</sub>			300	K/W	for PG-SOT23-3-15 (2s2p)
Thermal resistance Junction lead	R <sub>thJL</sub>			100	K/W	for PG-SOT23-3-15

1) This lifetime statement is an anticipation based on an extrapolation of Infineon's qualification test results. The actual lifetime of a component depends on its form of application and type of use etc. and may deviate from such statement. The lifetime statement shall in no event extend the agreed warranty period.

**Attention: Stresses above the max. values listed here may cause permanent damage to the device. Exposure to absolute maximum rating conditions for extended periods may affect device reliability. Maximum ratings are absolute ratings; exceeding only one of these values may cause irreversible damage to the integrated circuit.**

Calculation of the dissipated power P<sub>DIS</sub> and junction temperature T<sub>J</sub> of the chip (SOT23 example):

e.g. for: V<sub>DD</sub> = 12 V, I<sub>S</sub> = 2.5 mA, V<sub>QSAT</sub> = 0.5 V, I<sub>Q</sub> = 20 mA

Power dissipation: P<sub>DIS</sub> = 12 V x 2.5 mA + 0.5 V x 20 mA = 30 mW + 10 mW = 40 mW

Temperature ΔT = R<sub>thJA</sub> x P<sub>DIS</sub> = 300 K/W x 40 mW = 12 K

For T<sub>A</sub> = 150 °C: T<sub>J</sub> = T<sub>A</sub> + ΔT = 150 °C + 12 K = 162 °C

**Table 3-2 ESD Protection<sup>1)</sup> (TA = 25°C)**

Parameter	Symbol	Values	Unit	Note / Test Condition
		Min.		
ESD voltage (HBM) <sup>2)</sup>	V <sub>ESD</sub>	+/- 7	kV	R = 1.5 kΩ, C = 100 pF
ESD voltage (CDM) <sup>3)</sup>		+/- 1		
ESD voltage (system level) <sup>4)</sup>		+/- 15		

1) Characterization of ESD is carried out on a sample basis, not subject to production test.

2) Human Body Model (HBM) tests according to ANSI/ESDA/JEDEC JS-001.

3) Charge device model (CDM) tests according to JESD22-C101.

4) Gun test (2kΩ / 330pF or 330Ω / 150pF) according to ISO 10605-2008.

### 3.3 Operating Range

The following operating conditions must not be exceeded in order to ensure correct operation of the TLE4961-2M. All parameters specified in the following sections refer to these operating conditions unless otherwise mentioned.

**Table 3-3 Operating Conditions Parameters**

Parameter	Symbol	Values			Unit	Note / Test Condition
		Min.	Typ.	Max.		
Supply voltage	$V_{DD}$	3.0		32 <sup>1)</sup>	V	
Output voltage	$V_Q$	-0.3		32	V	
Junction temperature	$T_j$	-40		170	°C	
Output current	$I_Q$	0		25	mA	
Magnetic signal input frequency <sup>2)</sup>	$f_{SW}$	0		10	kHz	

- 1) Latch-up test with factor 1.5 is not covered. Please see max ratings also.
- 2) For operation at the maximum switching frequency the magnetic input signal must be 1.4 times higher than for static fields. This is due to the -3dB corner frequency of the internal low-pass filter in the signal path.

### 3.4 Electrical and Magnetic Characteristics

Product characteristics involve the spread of values guaranteed within the specified voltage and ambient temperature range. Typical characteristics are the median of the production and correspond to  $V_{DD} = 12\text{ V}$  and  $T_A = 25^\circ\text{C}$ . The below listed specification is valid in combination with the application circuit shown in [Figure 3-1](#) and [Figure 3-2](#)

**Table 3-4 General Electrical Characteristics**

Parameter	Symbol	Values			Unit	Note / Test Condition
		Min.	Typ.	Max.		
Supply current	$I_S$	1.1	1.6	2.5	mA	
Reverse current	$I_{SR}$		0.05	1	mA	for $V_{DD} = -18\text{ V}$
Output saturation voltage	$V_{QSAT}$		0.2	0.5	V	$I_Q = 20\text{ mA}$
			0.24	0.6	V	$I_Q = 25\text{ mA}$
Output leakage current	$I_{QLEAK}$			10	$\mu\text{A}$	
Output current limitation	$I_{QLIMIT}$	30	56	70	mA	internally limited & thermal shutdown
Output fall time <sup>1)</sup>	$t_f$	0.17	0.4	1	$\mu\text{s}$	1.2 k $\Omega$ / 50 pF, see <a href="#">Figure 2-3</a>
Output rise time <sup>1)</sup>	$t_r$	0.4	0.5	1	$\mu\text{s}$	1.2 k $\Omega$ / 50 pF, see <a href="#">Figure 2-3</a>
Output jitter <sup>1)2)</sup>	$t_{QJ}$		0.35	1	$\mu\text{s}$	For square wave signal with 1 kHz
Delay time <sup>1)3)</sup>	$t_d$	12	15	30	$\mu\text{s}$	see <a href="#">Figure 2-3</a>
Power-on time <sup>1)4)</sup>	$t_{PON}$		80	150	$\mu\text{s}$	$V_{DD} = 3\text{ V}$ , $B \leq B_{RP} - 0.5\text{ mT}$ or $B \geq B_{OP} + 0.5\text{ mT}$
Chopper frequency <sup>1)</sup>	$f_{OSC}$		350		kHz	

- 1) Not subject to production test, verified by design/characterization.
- 2) Output jitter is the  $1\sigma$  value of the output switching distribution.
- 3) Systematic delay between magnetic threshold reached and output switching.
- 4) Time from applying  $V_{DD} = 3.0\text{ V}$  to the sensor until the output is valid.

**Table 3-5 Magnetic Characteristics**

Parameter	Symbol	T (°C)	Values			Unit	Note / Test Condition
			Min.	Typ.	Max.		
Operating point	B <sub>OP</sub>	-40	3.2	5.7	8.1	mT	
		25	2.8	5	7.3		
		170	1.7	3.6	5.4		
Release point	B <sub>RP</sub>	-40	-8.1	-5.7	-3.2	mT	
		25	-7.3	-5	-2.8		
		170	-5.4	-3.6	-1.7		
Hysteresis	B <sub>HYS</sub>	-40	8.5	11.3	14.1	mT	
		25	7.5	10.0	12.5		
		170	5.3	7.1	8.9		
Effective noise value of the magnetic switching points <sup>1)</sup>	B <sub>Neff</sub>	25		62		μT	
Temperature compensation of magnetic thresholds <sup>2)</sup>	T <sub>C</sub>			-2000		ppm/K	

1) The magnetic noise is normal distributed and can be assumed as nearly independent to frequency without sampling noise or digital noise effects. The typical value represents the rms-value and corresponds therefore to a 1  $\sigma$  probability of normal distribution. Consequently a 3  $\sigma$  value corresponds to 99.7% probability of appearance.

2) Not subject to production test, verified by design/characterization.

**Field Direction Definition**

Positive magnetic fields are defined with the south pole of the magnet to the branded side of package.

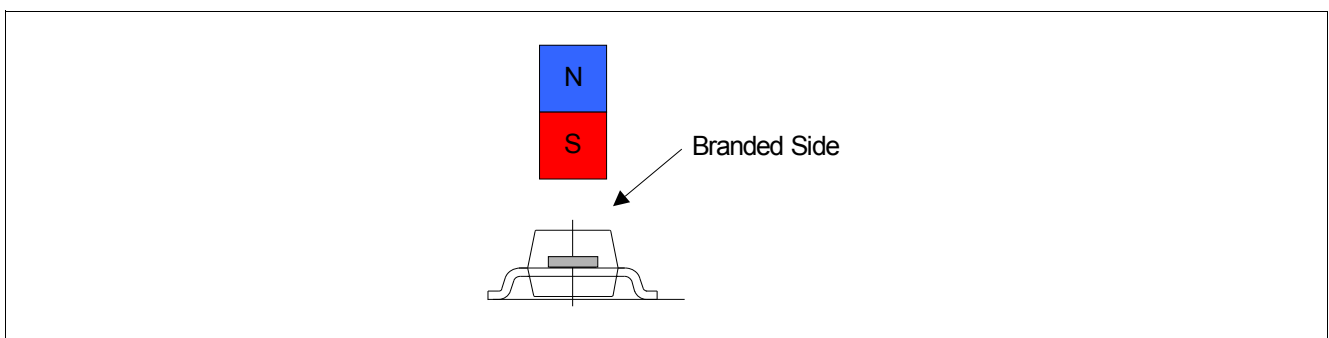

**Figure 3-3 Definition of Magnetic Field Direction PG-SOT23-3-15**



### 3.5 Electro Magnetic Compatibility

Characterization of Electro Magnetic Compatibility is carried out on a sample basis from one qualification lot. Not all specification parameters have been monitored during EMC exposure.

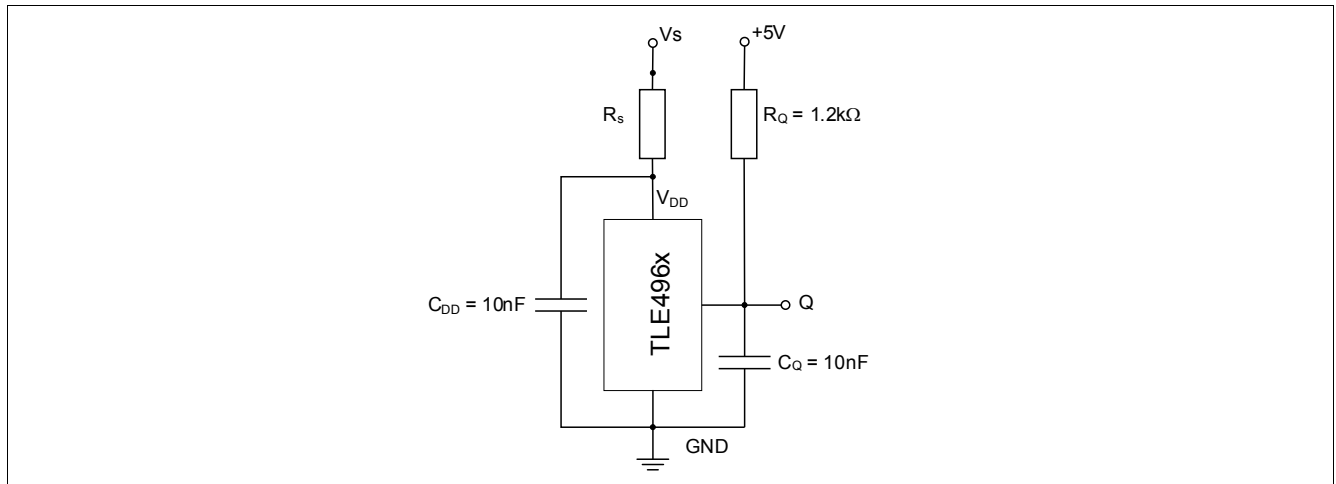

Figure 3-4 EMC Test Circuit

Ref: ISO 7637-2 (Version 2004), test circuit [Figure 3.4](#) (with external resistor,  $R_S = 100 \Omega$ )

Table 3-6 Magnetic Compatibility

Parameter	Symbol	Level / Type	Status
Testpulse 1	$V_{EMC}$	-100 V	C
Testpulse 2a <sup>1)</sup>		60 V/110 V	A/C
Testpulse 2b		10 V	C
Testpulse 3a		-150 V	A
Testpulse 3b		100 V	A
Testpulse 4 <sup>2)</sup>		-7 V / -5.5 V	A
Testpulse 5b <sup>3)</sup>		$U_S = 86.5 \text{ V} / U_S^* = 28.5 \text{ V}$	A

1) ISO 7637-2 (2004) describes internal resistance = 2  $\Omega$  (former 10  $\Omega$ ).

2) According to 7637-2 for test pulse 4 the test voltage shall be 12 V +/- 0.2 V.

3) A central load dump protection of 42 V is used.  $U_S^* = 42 \text{ V}$ -13.5 V.

Ref: ISO 7637-2 (Version 2004), test circuit [Figure 3.4](#) (without external resistor,  $R_S = 0\Omega$ )

Table 3-7 Electro Magnetic Compatibility

Parameter	Symbol	Level / Type	Status
Testpulse 1	$V_{EMC}$	-50 V	C
Testpulse 2a <sup>1)</sup>		50 V	A
Testpulse 2b		10 V	C
Testpulse 3a		-150 V	A
Testpulse 3b		100 V	A
Testpulse 4 <sup>2)</sup>		-7 V / 5.5 V	A
Testpulse 5b <sup>3)</sup>		$U_S = 86.5 \text{ V} / U_S^* = 28.5 \text{ V}$	A

1) ISO 7637-2 (2004) describes internal resistance = 2  $\Omega$  (former 10  $\Omega$ ).

2) According to 7637-2 for test pulse 4 the test voltage shall be 12 V +/- 0.2 V.

3) A central load dump protection of 42 V is used.  $U_S^* = 42 \text{ V}$ -13.5 V.

## 4 Package Information

The TLE4961-2M is available in the small halogen free SMD package PG-SOT23-3-15.

### 4.1 Package Outline PG-SOT23-3-15

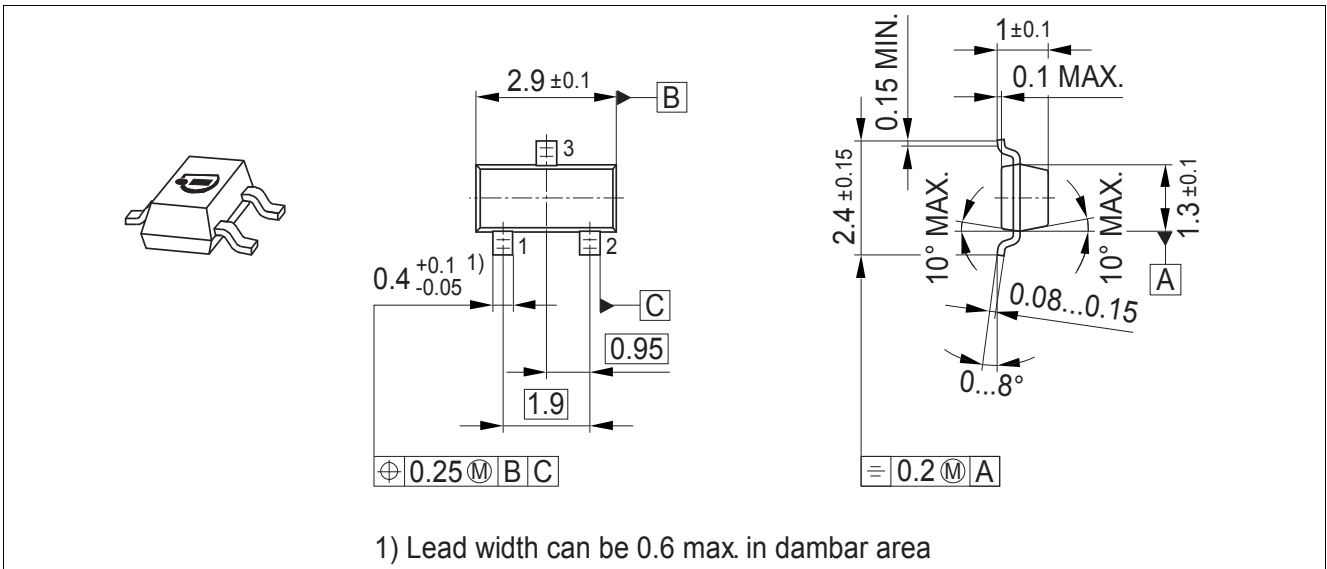

Figure 4-1 PG-SOT23-3-15 Package Outline (All Dimensions in mm)

### 4.2 Packing Information PG-SOT23-3-15

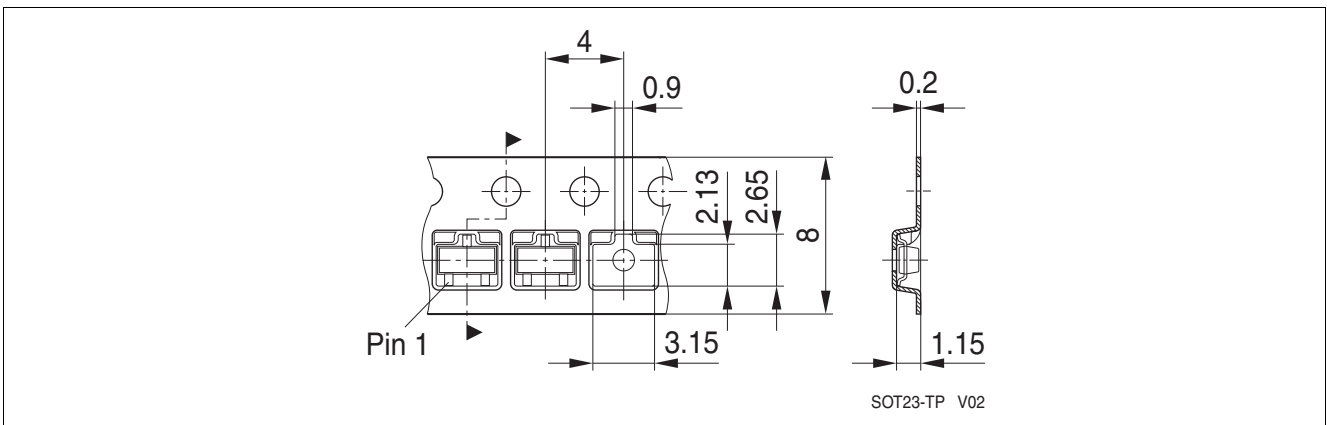

Figure 4-2 Packing of the PG-SOT23-3-15 in a Tape

### 4.3 Footprint PG-SC59-3-5 and PG-SOT23-3-15

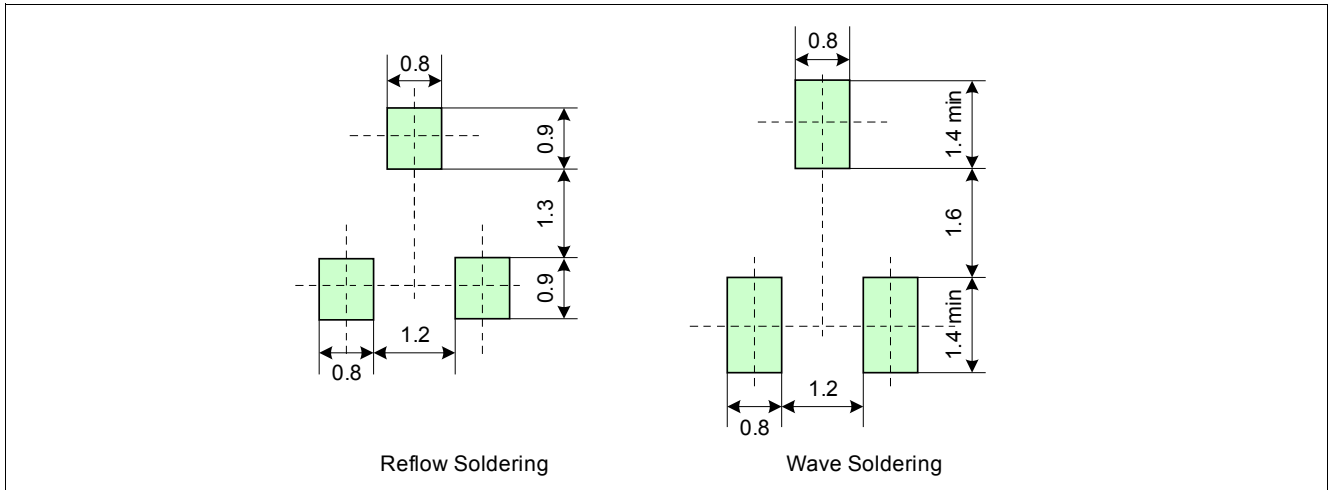

Figure 4-3 Footprint PG-SC59-3-5 and PG-SOT23-3-15

### 4.4 PG-SOT23-3-15 Distance between Chip and Package

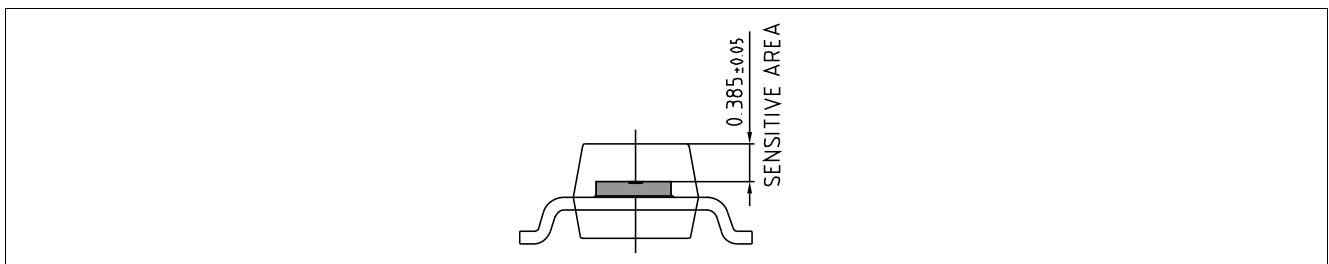

Figure 4-4 Distance between Chip and Package

### 4.5 Package Marking

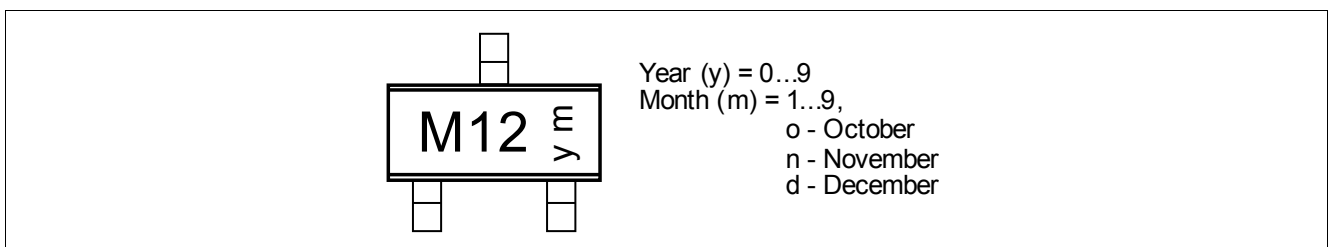

Figure 4-5 Marking of TLE4961-2M

## 5 Graphs of the Magnetic Parameters

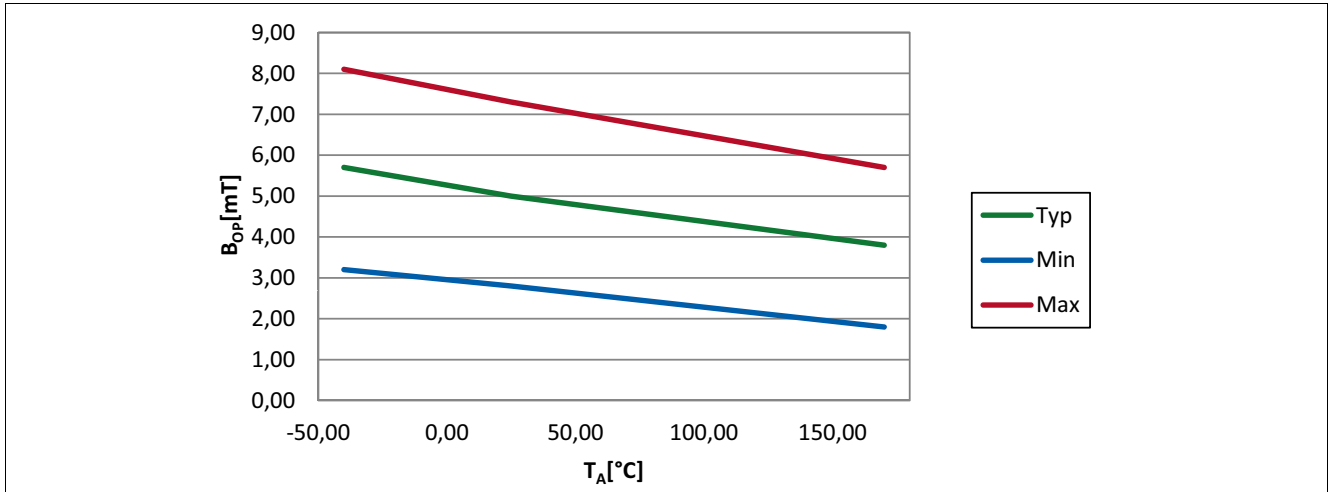

Figure 5-1 Operating Point (B<sub>OP</sub>) of the TLE4961-2M over Temperature

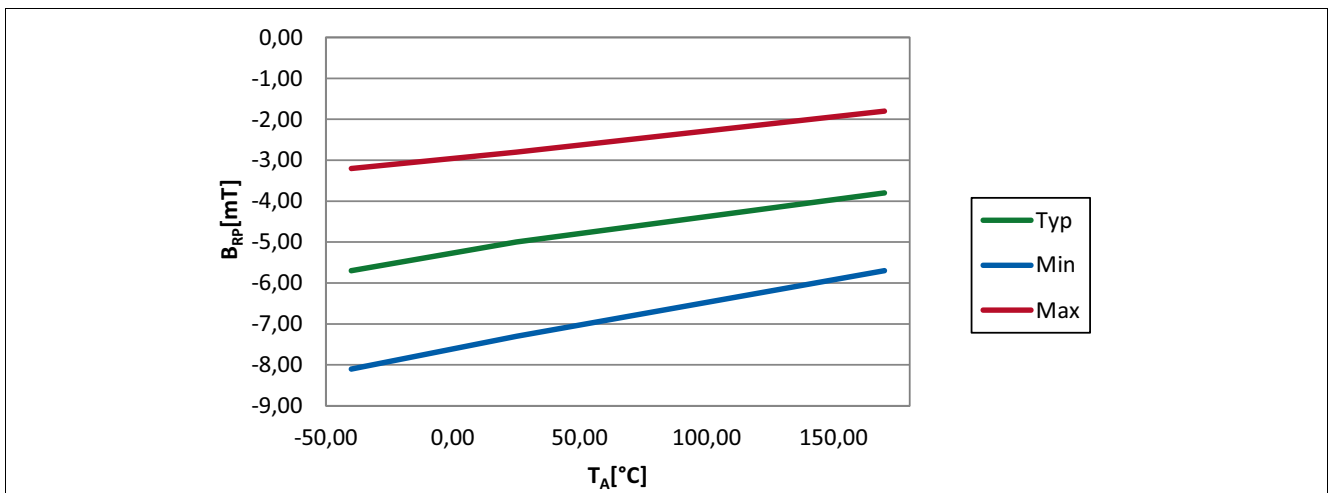

Figure 5-2 Release Point (B<sub>RP</sub>) of the TLE4961-2M over Temperature

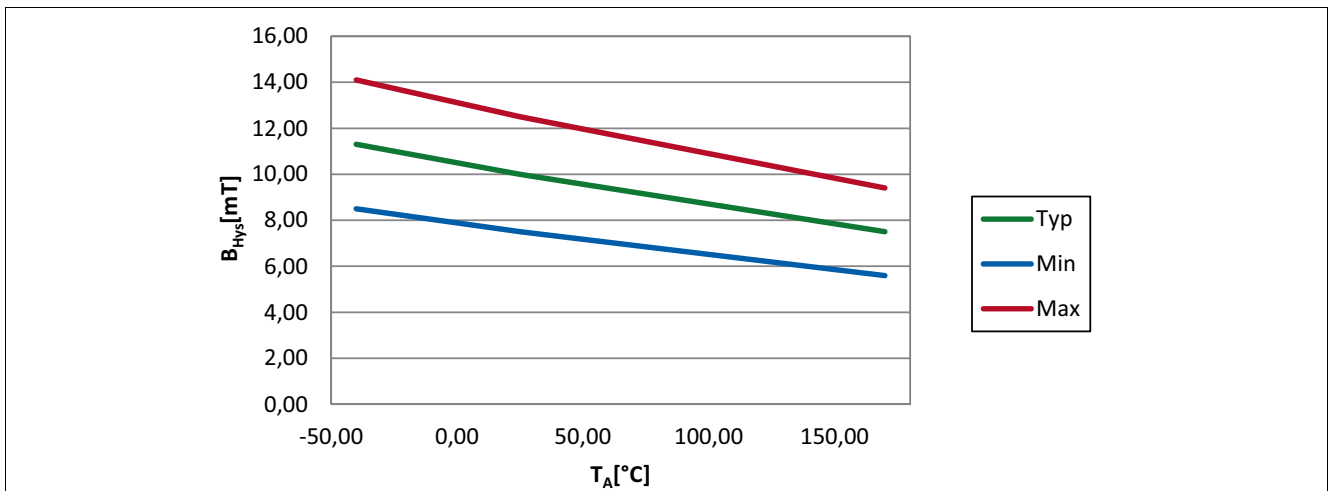

Figure 5-3 Hysteresis (B<sub>Hys</sub>) of the TLE4961-2M over Temperature

## 6 Graphs of the Electrical Parameters

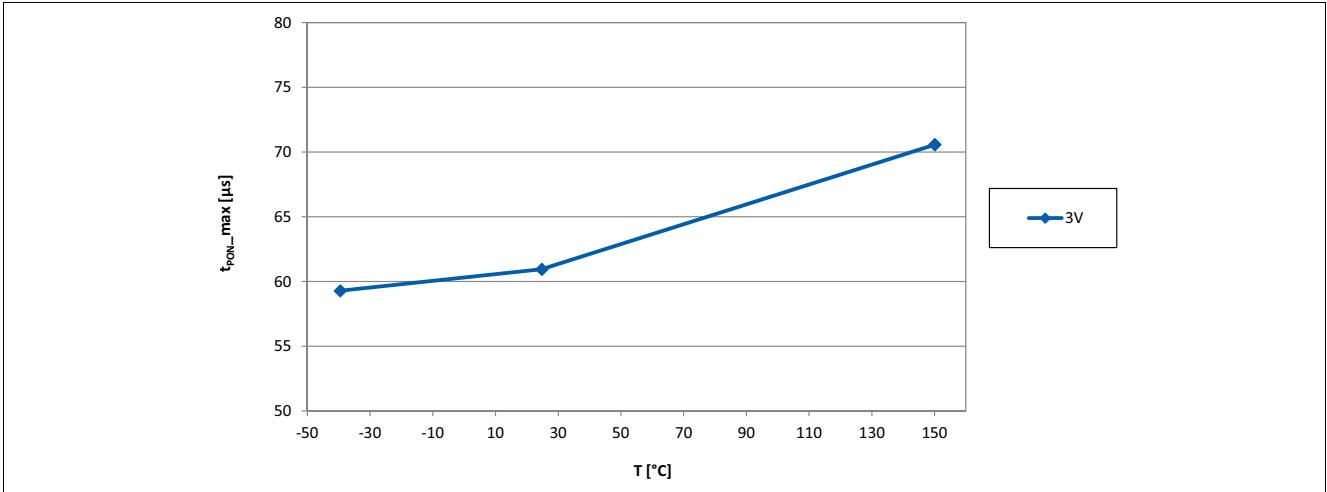

Figure 6-1 Power On Time  $t_{PON}$  of the TLE4961-2M over Temperature

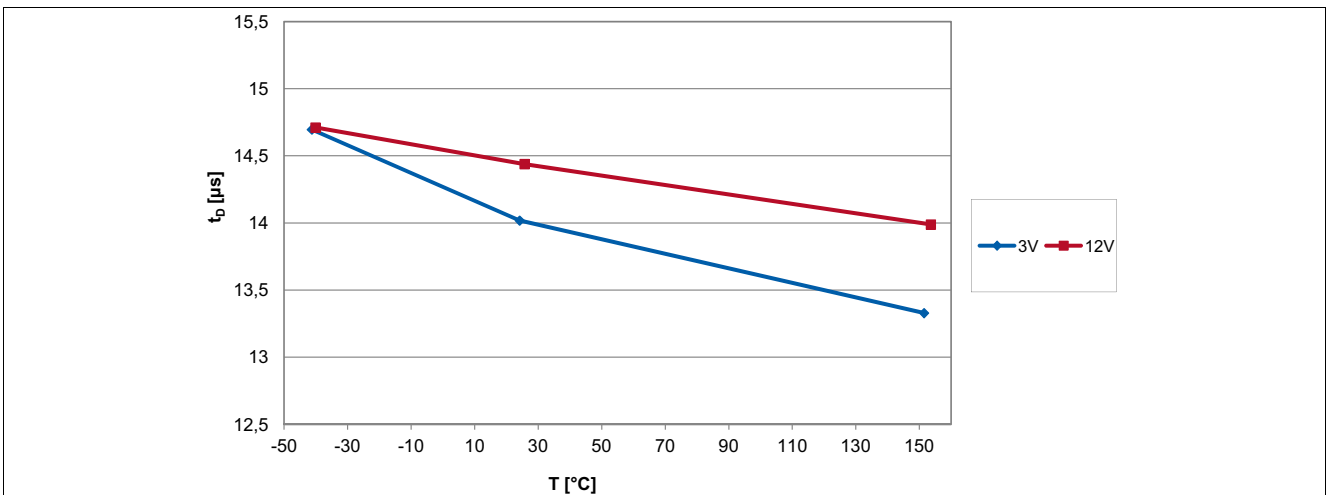

Figure 6-2 Signal Delay Time of the TLE4961-2M over Temperature

Graphs of the Electrical Parameters

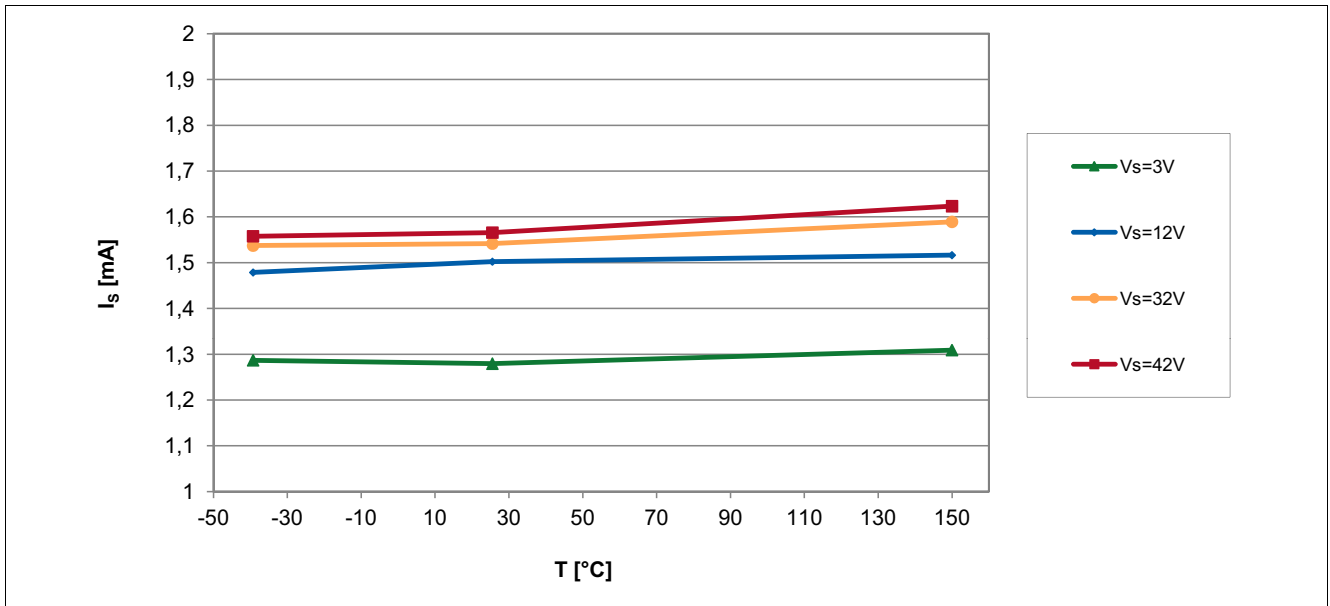

Figure 6-3 Supply Current of the TLE4961-2M over Temperature

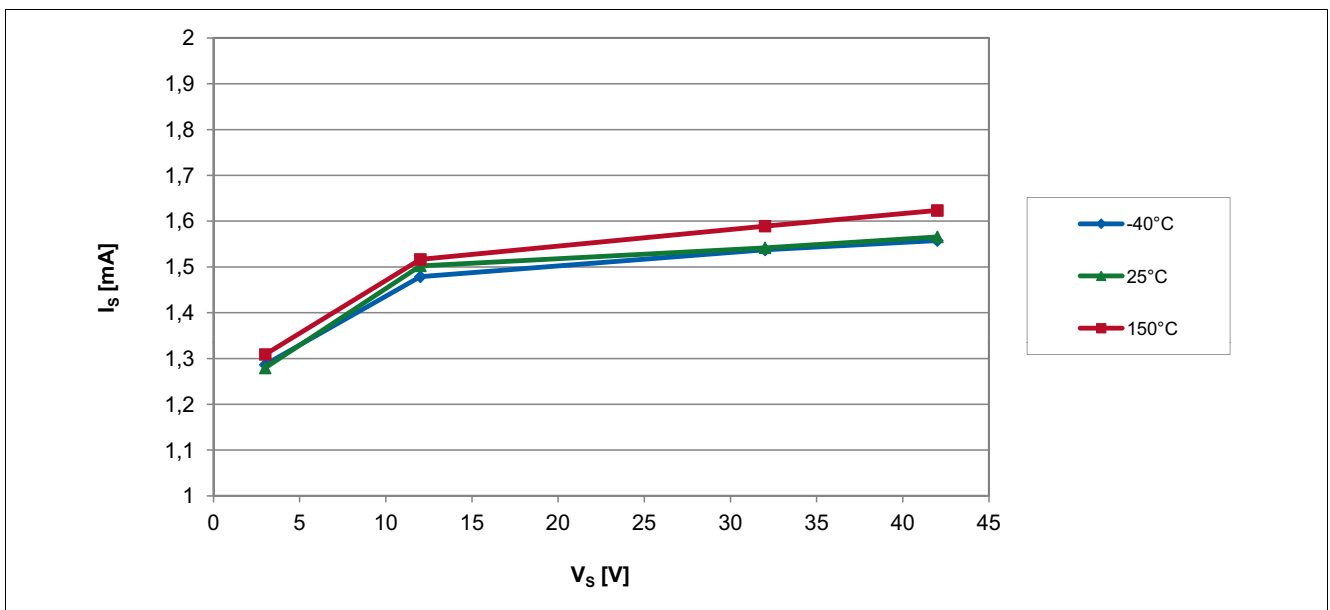

Figure 6-4 Supply Current of the TLE4961-2M over Supply Voltage

Graphs of the Electrical Parameters

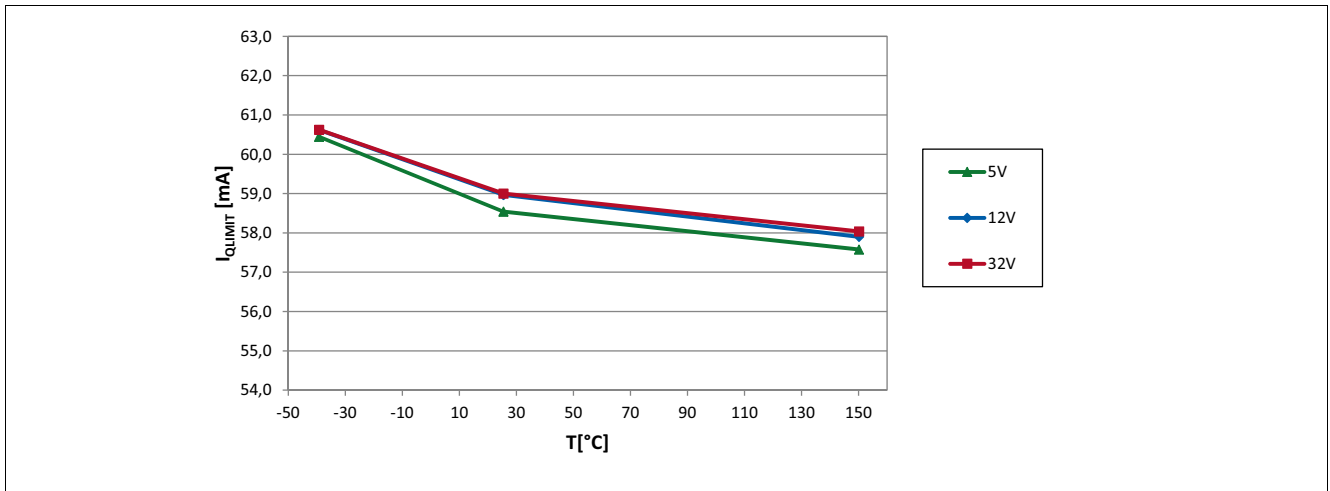

Figure 6-5 Output Current Limit of the TLE4961-2M over Temperature

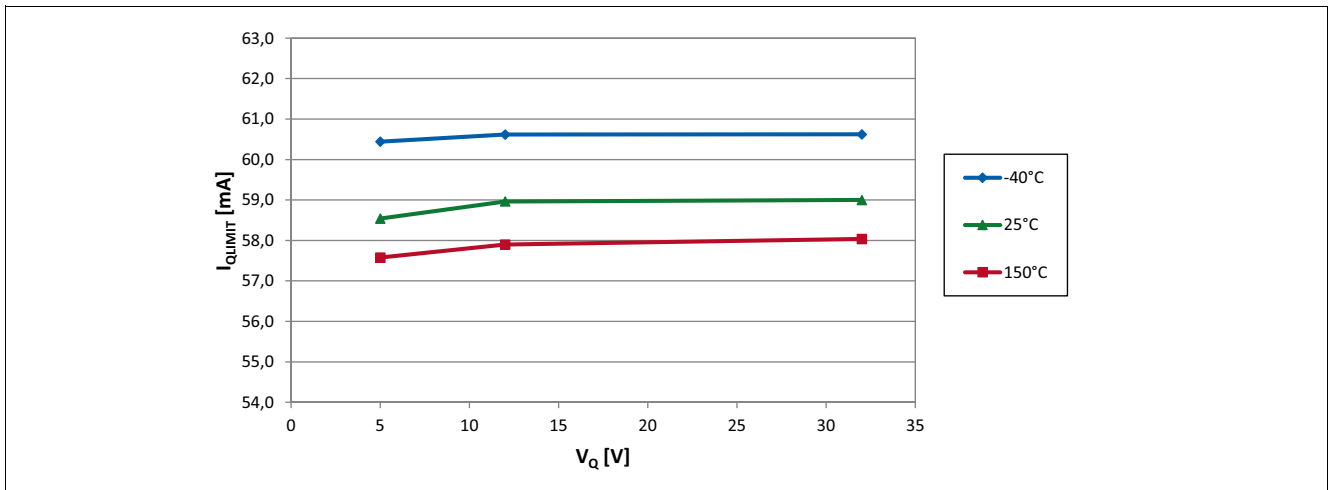

Figure 6-6 Output Current Limit of the TLE4961-2M over applied Pull-up Voltage

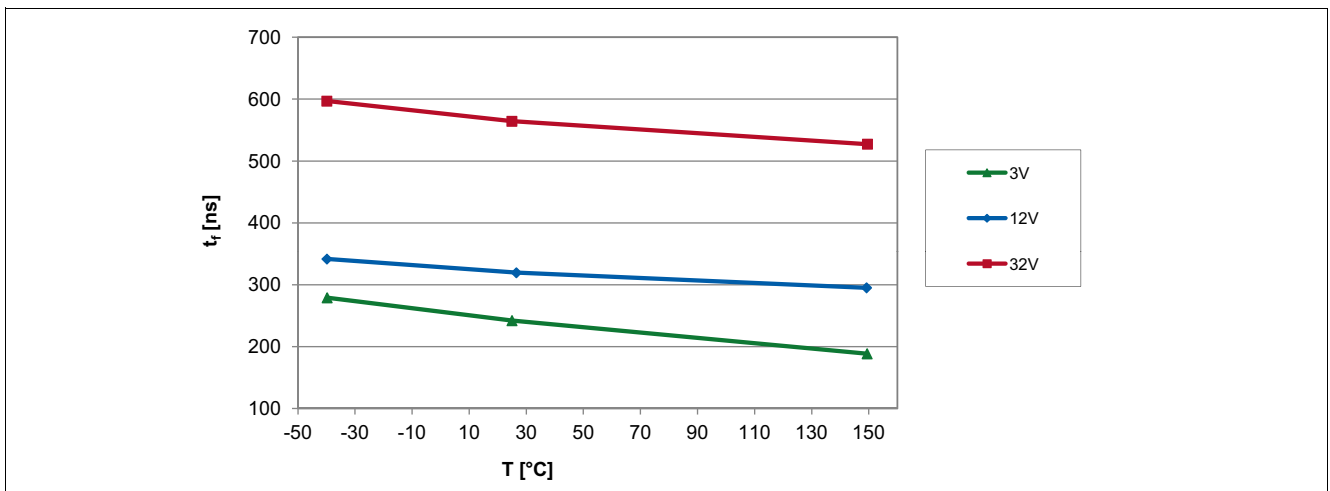

Figure 6-7 Output Fall Time of the TLE4961-2M over Temperature

Graphs of the Electrical Parameters

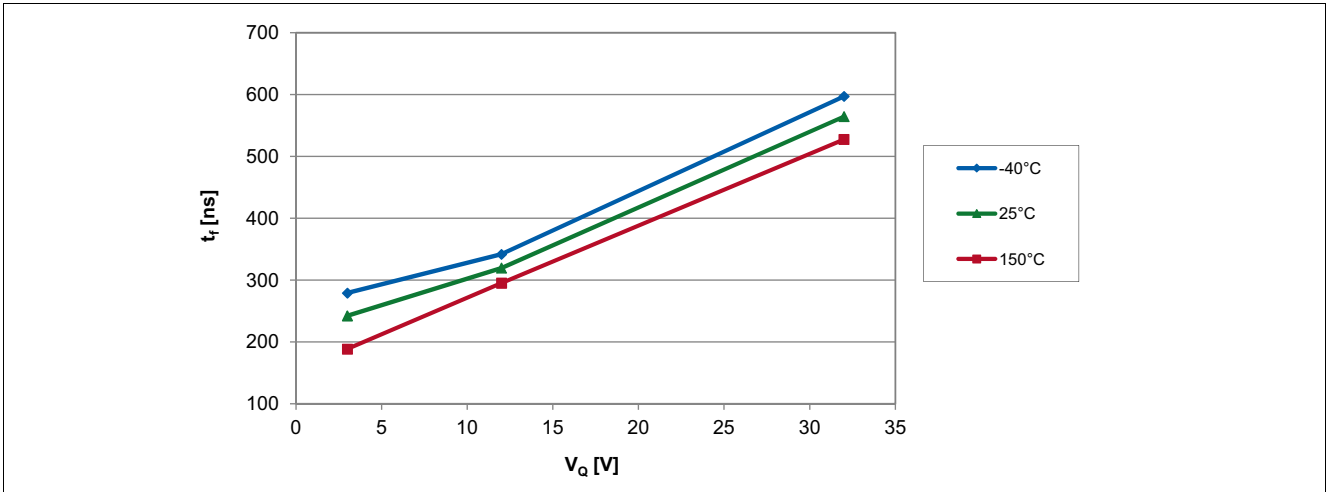

Figure 6-8 Output Fall Time of the TLE4961-2M over applied Pull-up Voltage

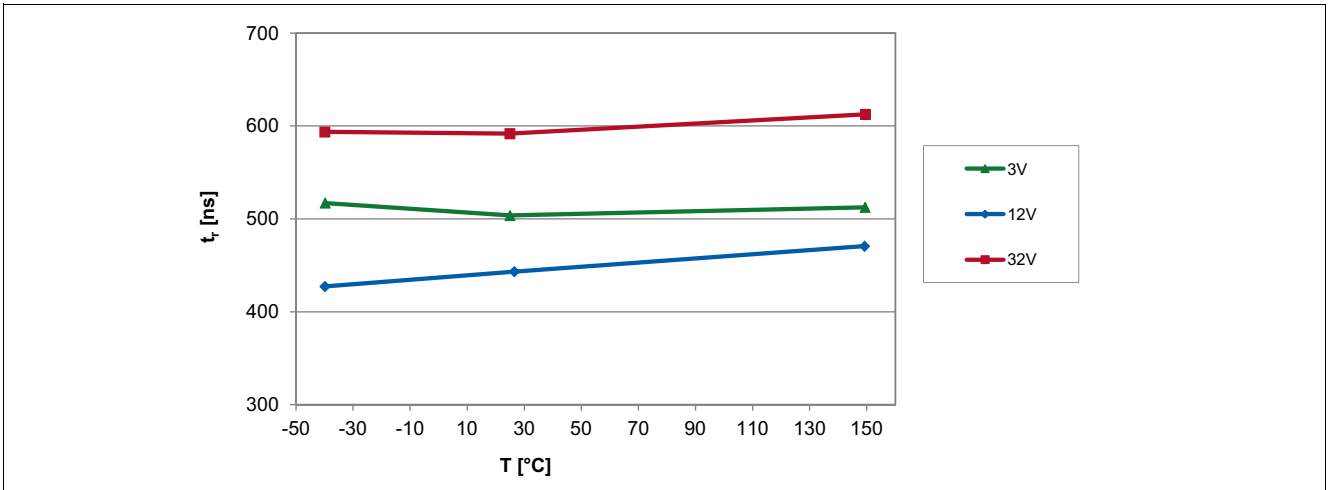

Figure 6-9 Output Rise Time of the TLE4961-2M over Temperature

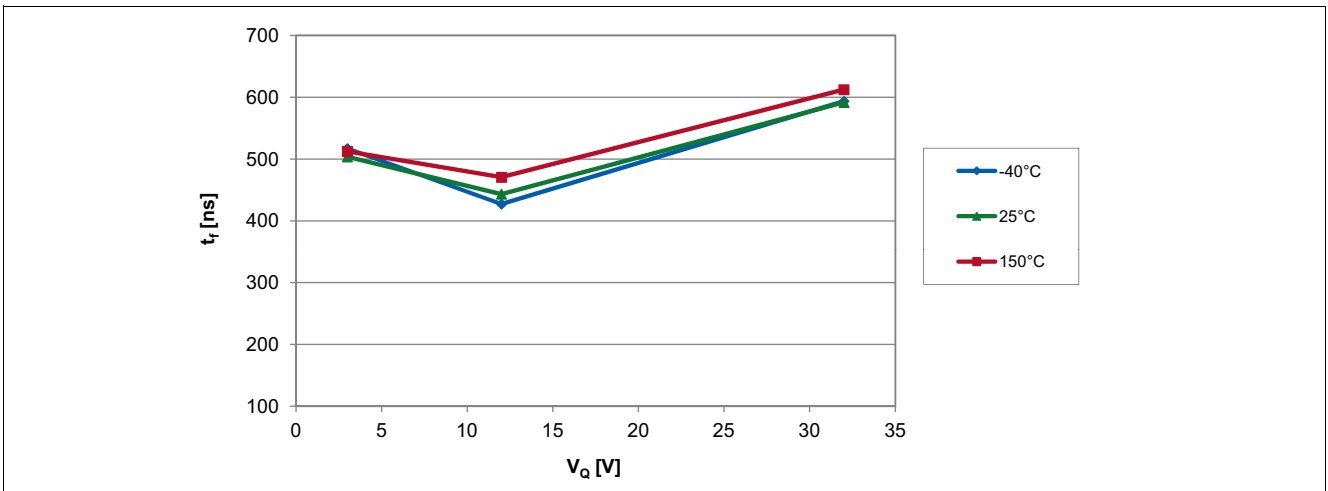

Figure 6-10 Output Rise Time of the TLE4961-2M over applied Pull-up Voltage



Graphs of the Electrical Parameters

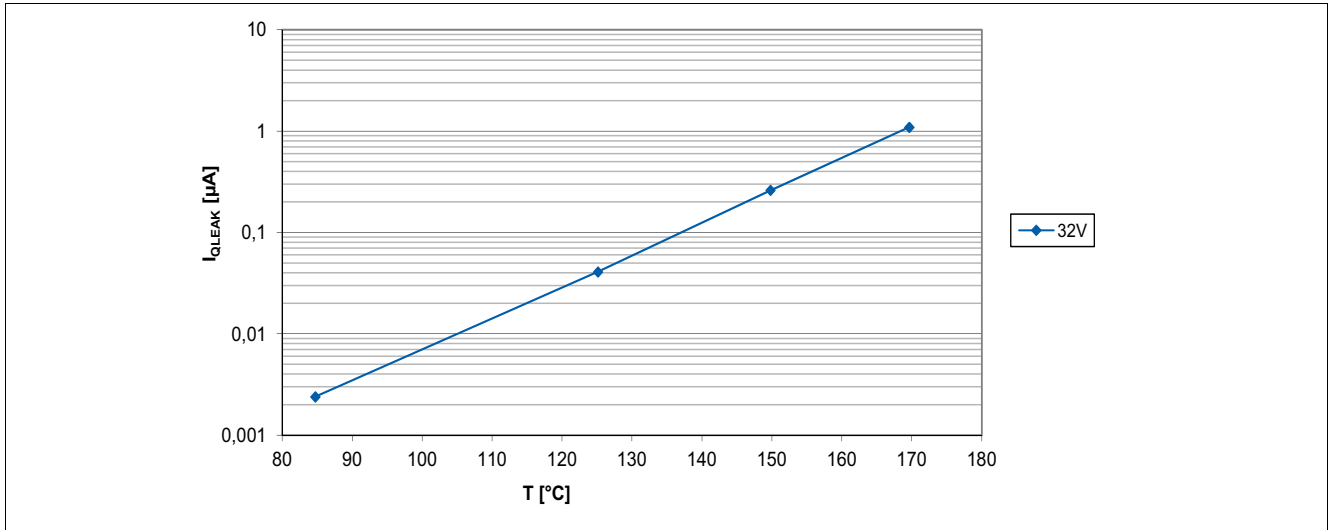

Figure 6-11 Output Leakage Current of the TLE4961-2M over Temperature

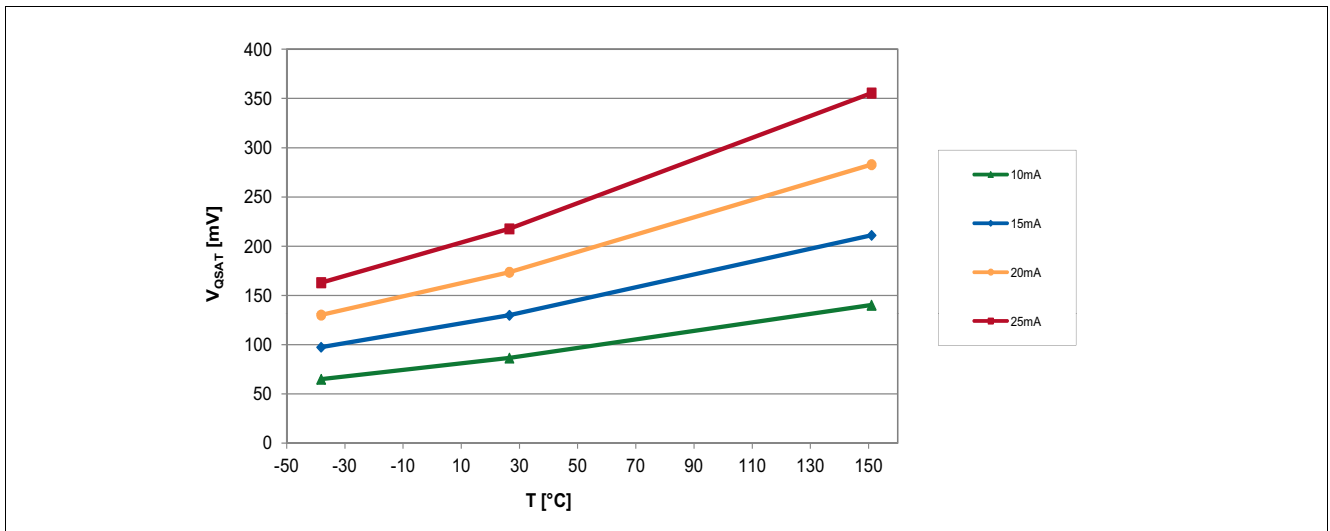

Figure 6-12 Saturation Voltage of the TLE4961-2M over Temperature

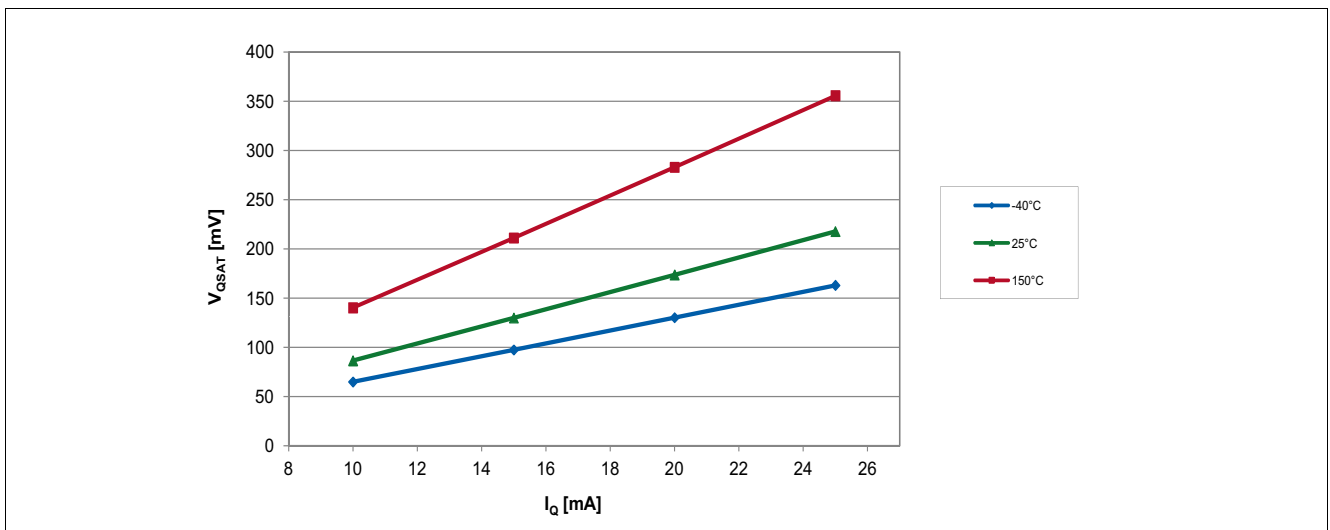

Figure 6-13 Saturation Voltage of the TLE4961-2M over Output Current

Graphs of the Electrical Parameters

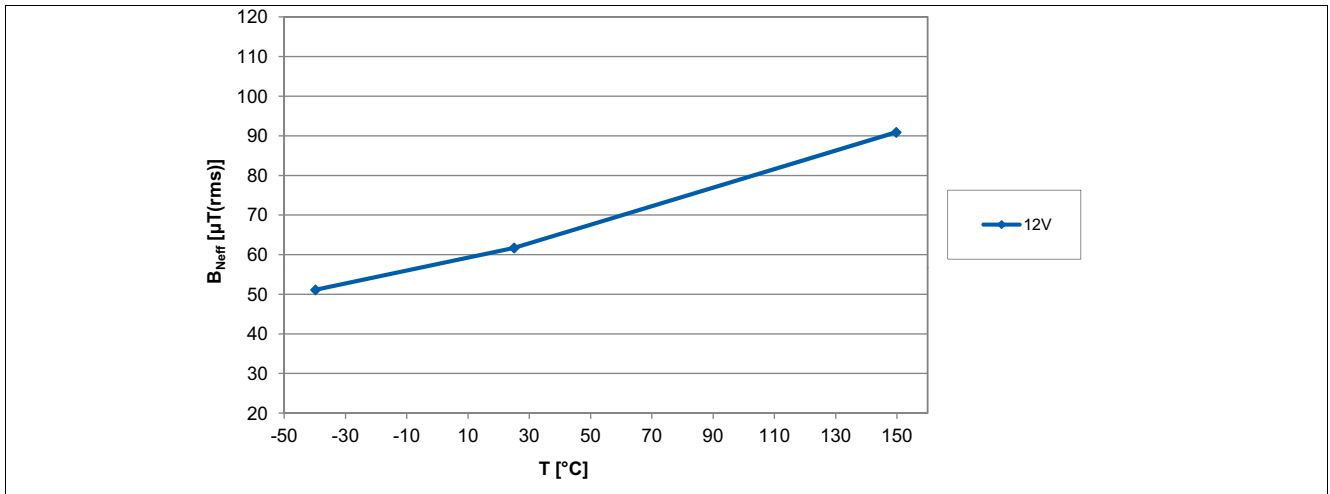

Figure 6-14 Effective Noise of the TLE4961-2M Thresholds over Temperature

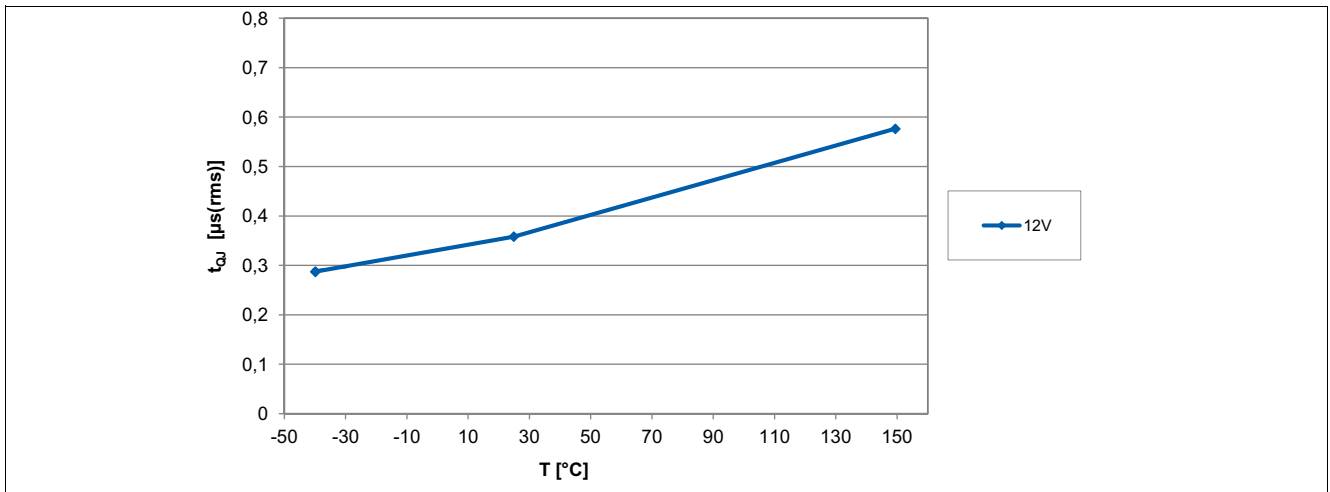

Figure 6-15 Output Signal Jitter of the TLE4961-2M over Temperature