



Chipsmall Limited consists of a professional team with an average of over 10 year of expertise in the distribution of electronic components. Based in Hongkong, we have already established firm and mutual-benefit business relationships with customers from,Europe,America and south Asia,supplying obsolete and hard-to-find components to meet their specific needs.

With the principle of “Quality Parts,Customers Priority,Honest Operation,and Considerate Service”,our business mainly focus on the distribution of electronic components. Line cards we deal with include Microchip,ALPS,ROHM,Xilinx,Pulse,ON,Everlight and Freescale. Main products comprise IC,Modules,Potentiometer,IC Socket,Relay,Connector.Our parts cover such applications as commercial,industrial, and automotives areas.

We are looking forward to setting up business relationship with you and hope to provide you with the best service and solution. Let us make a better world for our industry!



Contact us

Tel: +86-755-8981 8866 Fax: +86-755-8427 6832

Email & Skype: info@chipsmall.com Web: www.chipsmall.com

Address: A1208, Overseas Decoration Building, #122 Zhenhua RD., Futian, Shenzhen, China



TLE8251V

High Speed CAN Transceiver with Bus Wake-up



1 Overview

Features

- Compliant to ISO11898-2: 2003 and ISO11898-5: 2007
- Wide common mode range for electromagnetic immunity (EMI)
- Very low electromagnetic emission (EME)
- Excellent ESD robustness
- Guaranteed and improved loop delay symmetry to support CAN FD data frames up to 2 MBit/s for Japanese OEMs
- V_{IO} input for voltage adaption to the microcontroller supply
- Extended supply range on V_{CC} and V_{IO} supply
- CAN short circuit proof to ground, battery and V_{CC}
- TxD time-out function
- Low CAN bus leakage current in power-down state
- Overtemperature protection
- Protected against automotive transients
- Stand-by mode with remote wake-up function
- Wake-up indication on the RxD output
- Transmitter supply V_{CC} can be turned off in stand-by mode
- Green Product (RoHS compliant)
- AEC Qualified
- Certified according to latest VeLIO (Vehicle LAN Interoperability & Optimization) test requirements for the Japanese market

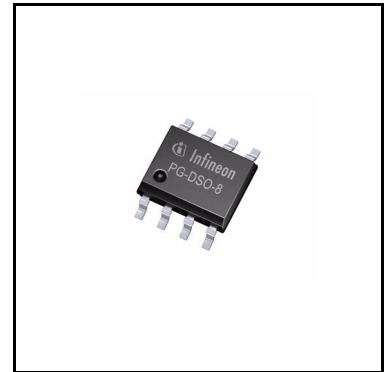

Applications

- Gateway Modules
- Body Control Modules (BCMs)
- Electric Power steering
- Battery Management Systems
- Cluster and Lighting Control Modules

Description

The TLE8251VSJ is a transceiver designed for HS CAN networks in automotive and industrial applications. As an interface between the physical bus layer and the CAN protocol controller, the TLE8251VSJ drives the

Overview

signals to the bus and protects the microcontroller against interferences generated within the network. Based on the high symmetry of the CANH and CANL signals, the TLE8251VSJ provides a very low level of electromagnetic emission (EME) within a wide frequency range.

The TLE8251VSJ fulfills or exceeds the requirements of the ISO11898-2.

The TLE8251VSJ provides a digital supply input V_{IO} and a stand-by mode. It is designed to fulfill the enhanced physical layer requirements for CAN FD and supports data rates up to 2 MBit/s.

On the basis of a very low leakage current on the HS CAN bus interface the TLE8251VSJ provides an excellent passive behavior in power-down state. These and other features make the TLE8251VSJ exceptionally suitable for mixed supply HS CAN networks.

Based on the Infineon Smart Power Technology SPT, the TLE8251VSJ provides excellent ESD immunity together with a very high electromagnetic immunity (EMI). The TLE8251VSJ and the Infineon SPT technology are AEC qualified and tailored to withstand the harsh conditions of the automotive environment.

Two different operating modes, additional fail-safe features like a TxD time-out and the optimized output slew rates on the CANH and CANL signals make the TLE8251VSJ the ideal choice for large HS CAN networks with high data transmission rates.

| Type | Package | Marking |
|------------|----------|---------|
| TLE8251VSJ | PG-DSO-8 | 8251V |

Table of Contents

| | | |
|-----------|---|-----------|
| 1 | Overview | 1 |
| | Table of Contents | 3 |
| 2 | Block Diagram | 4 |
| 3 | Pin Configuration | 5 |
| 3.1 | Pin Assignment | 5 |
| 3.2 | Pin Definitions | 5 |
| 4 | Functional Description | 6 |
| 4.1 | High Speed CAN Physical Layer | 6 |
| 4.2 | Modes of Operation | 8 |
| 4.2.1 | Normal-operating Mode | 8 |
| 4.2.2 | Stand-by Mode | 8 |
| 4.3 | Power-up and Undervoltage Condition | 9 |
| 4.3.1 | Power-down State | 10 |
| 4.3.2 | Forced Stand-by Mode | 10 |
| 4.3.3 | Power-up | 10 |
| 4.3.4 | Undervoltage on the Digital Supply V_{IO} | 11 |
| 4.3.5 | Undervoltage on the Transmitter Supply V_{CC} | 12 |
| 4.3.6 | Voltage Adaption to the Microcontroller Supply | 12 |
| 4.4 | Remote Wake-up | 13 |
| 5 | Fail Safe Functions | 14 |
| 5.1 | Short Circuit Protection | 14 |
| 5.2 | Unconnected Logic Pins | 14 |
| 5.3 | TxD Time-out Function | 14 |
| 5.4 | Overtemperature Protection | 15 |
| 5.5 | Delay Time for Mode Change | 15 |
| 6 | General Product Characteristics | 16 |
| 6.1 | Absolute Maximum Ratings | 16 |
| 6.2 | Functional Range | 17 |
| 6.3 | Thermal Resistance | 17 |
| 7 | Electrical Characteristics | 18 |
| 7.1 | Functional Device Characteristics | 18 |
| 7.2 | Diagrams | 24 |
| 8 | Application Information | 26 |
| 8.1 | ESD Robustness according to IEC61000-4-2 | 26 |
| 8.2 | Application Example | 27 |
| 8.3 | Examples for Mode Changes | 27 |
| 8.3.1 | Mode Change to Stand-by Mode during a dominant Bus Signal | 29 |
| 8.3.2 | Mode Change from Stand-by Mode to Normal-operating Mode | 30 |
| 8.3.2.1 | Mode Change while the TxD Signal is “low” | 30 |
| 8.3.2.2 | Mode Change while the Bus Signal is dominant | 31 |
| 8.4 | Further Application Information | 32 |
| 9 | Package Outline | 33 |
| 10 | Revision History | 34 |

Block Diagram

2 Block Diagram

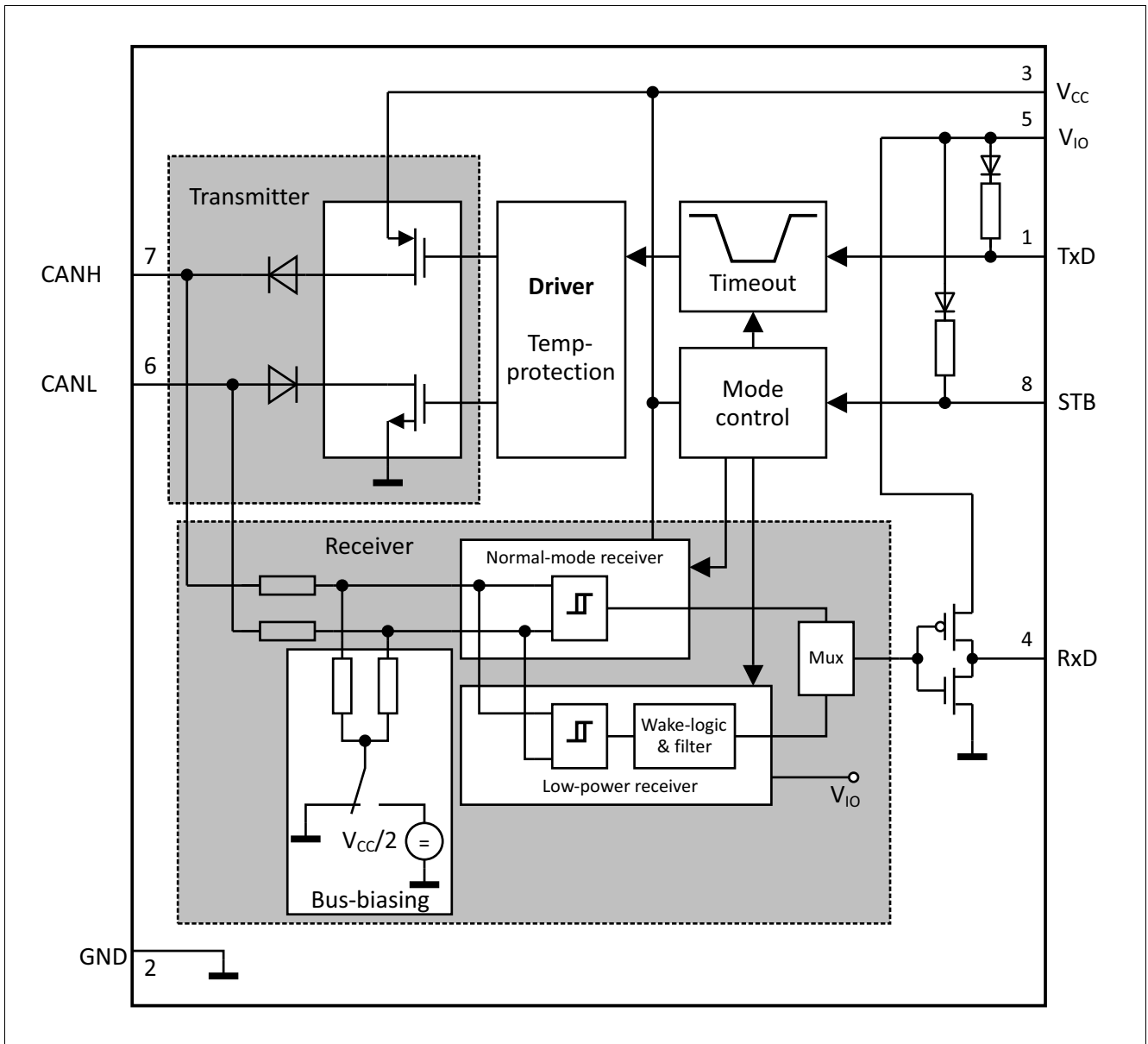

Figure 1 Functional block diagram

3 Pin Configuration

3.1 Pin Assignment

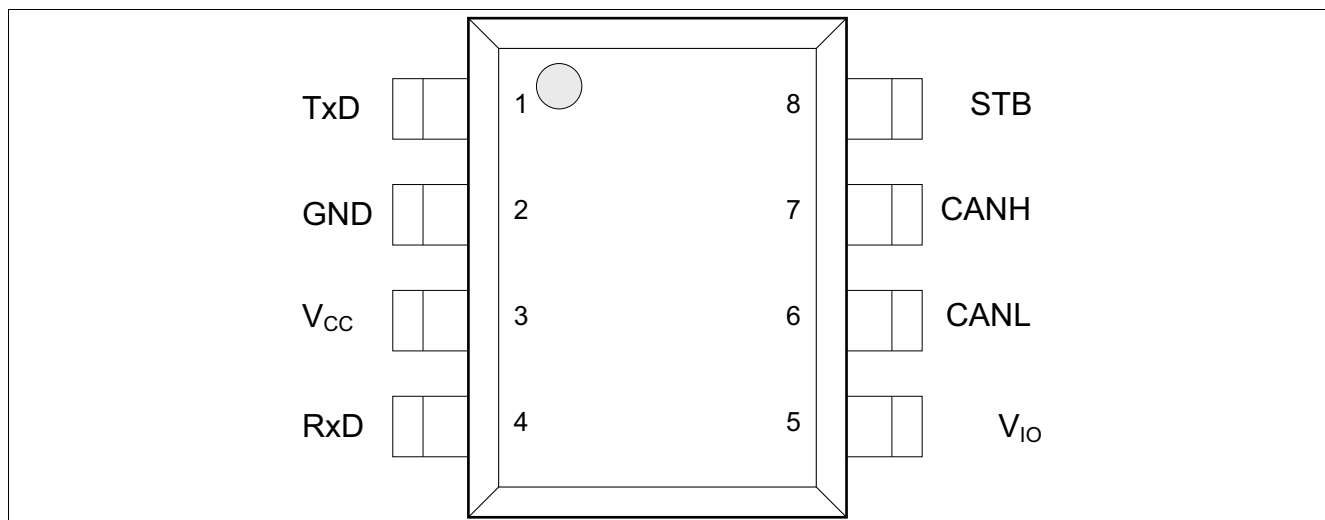

Figure 2 Pin configuration

3.2 Pin Definitions

Table 1 Pin definitions and functions

| Pin No. | Symbol | Function |
|---------|----------|---|
| 1 | TxD | Transmit Data Input; internal pull-up to V_{IO} , “low” for dominant state. |
| 2 | GND | Ground |
| 3 | V_{CC} | Transmitter Supply Voltage; 100 nF decoupling capacitor to GND required, V_{CC} can be turned off in stand-by mode. |
| 4 | RxD | Receive Data Output; “low” in dominant state. |
| 5 | V_{IO} | Digital Supply Voltage; supply voltage input to adapt the logical input and output voltage levels of the transceiver to the microcontroller supply, supply for the low-power receiver, 100 nF decoupling capacitor to GND required. |
| 6 | CANL | CAN Bus Low Level I/O; “low” in dominant state. |
| 7 | CANH | CAN Bus High Level I/O; “high” in dominant state. |
| 8 | STB | Stand-by Input; internal pull-up to V_{IO} , “low” for normal-operating mode. |

Functional Description

4 Functional Description

HS CAN is a serial bus system that connects microcontrollers, sensors and actuators for real-time control applications. The use of the Controller Area Network (abbreviated CAN) within road vehicles is described by the international standard ISO 11898. According to the 7-layer OSI reference model the physical layer of a HS CAN bus system specifies the data transmission from one CAN node to all other available CAN nodes within the network. The physical layer specification of a CAN bus system includes all electrical and mechanical specifications of a CAN network. The CAN transceiver is part of the physical layer specification. Several different physical layer standards of CAN networks have been developed in recent years. The TLE8251VSJ is a High Speed CAN transceiver with a dedicated bus wake-up function and defined by the international standard ISO 11898-5.

4.1 High Speed CAN Physical Layer

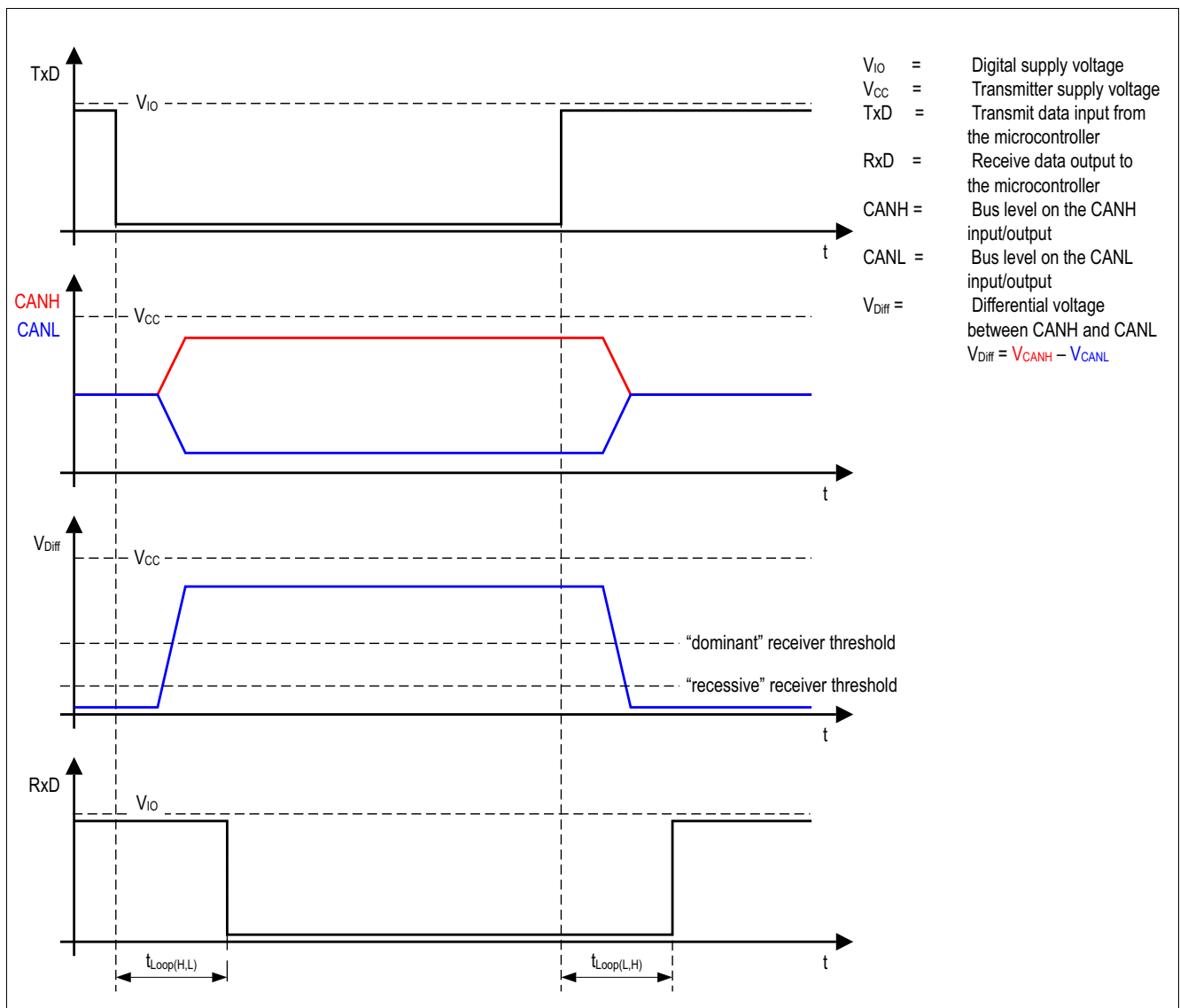

Figure 3 High speed CAN bus signals and logic signals

Functional Description

The TLE8251VSJ is a High-Speed CAN transceiver, operating as an interface between the CAN controller and the physical bus medium. A HS CAN network is a two wire, differential network which allows data transmission rates for CAN FD frames up to 2 MBit/s. Characteristic for HS CAN networks are the two signal states on the HS CAN bus: dominant and recessive (see [Figure 3](#)).

V_{CC} , V_{IO} and GND are the supply pins for the TLE8251VSJ. The pins CANH and CANL are the interface to the HS CAN bus and operate in both directions, as an input and as an output. RxD and TxD pins are the interface to the CAN controller, the TxD pin is an input pin and the RxD pin is an output pin. The STB pin is the input pin for mode selection (see [Figure 4](#)).

By setting the TxD input pin to logical “low” the transmitter of the TLE8251VSJ drives a dominant signal to the CANH and CANL pins. Setting TxD input to logical “high” turns off the transmitter and the output voltage on CANH and CANL discharges towards the recessive level. The recessive output voltage is provided by the bus biasing (see [Figure 1](#)). The output of the transmitter is considered to be dominant, when the voltage difference between CANH and CANL is greater than 1.5 V ($V_{Diff} = V_{CANH} - V_{CANL}$).

Parallel to the transmitter the normal-mode receiver monitors the signal on the CANH and CANL pins and indicates it on the RxD output pin. A dominant signal on the CANH and CANL pins sets the RxD output pin to logical “low”, vice versa a recessive signal sets the RxD output to logical “high”. The normal-mode receiver considers a voltage difference (V_{Diff}) between CANH and CANL above 0.9 V as dominant and below 0.5 V as recessive.

To conform with HS CAN features, like the bit to bit arbitration, the signal on the RxD output has to follow the signal on the TxD input within a defined loop delay $t_{Loop} \leq 255$ ns.

The thresholds of the digital inputs (TxD and STB) and of the RxD output voltage are adapted to the digital power supply V_{IO} .

4.2 Modes of Operation

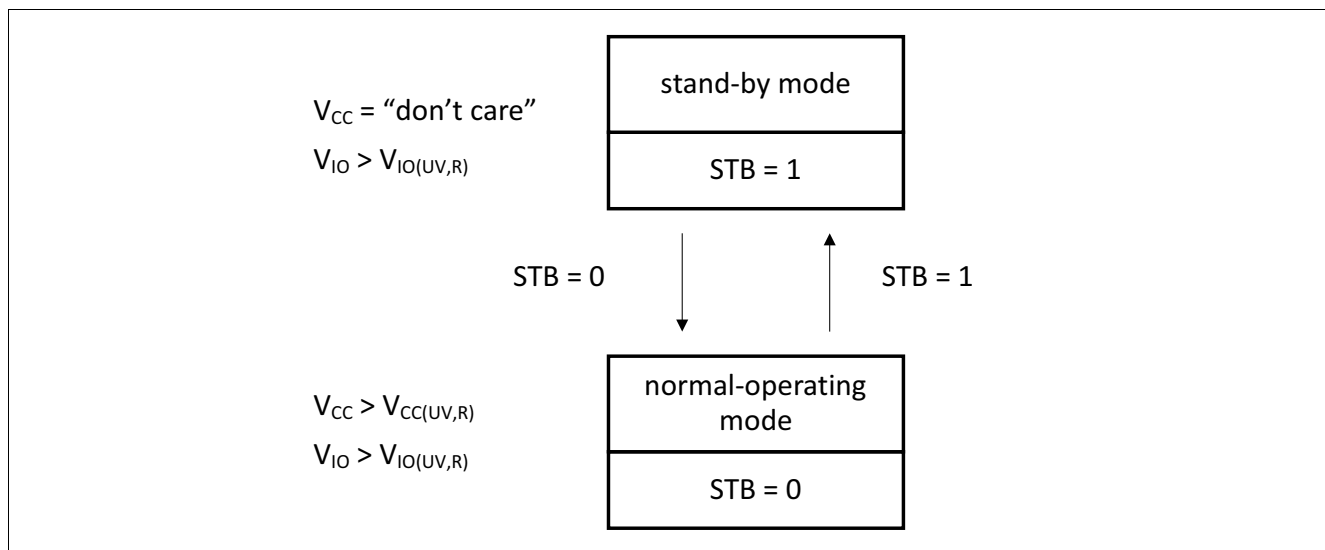

Figure 4 Mode state diagram

4.2.1 Normal-operating Mode

In normal-operating mode the transmitter and the receiver of the HS CAN transceiver TLE8251VSJ are active (see [Figure 1](#)). The HS CAN transceiver sends the serial data stream on the TxD input pin to the CAN bus. The data on the CAN bus is displayed at the RxD pin simultaneously. A logical "low" signal on the STB pin selects the normal-operating mode, while the transceiver is supplied by V_{CC} and V_{IO} (see [Table 2](#) for details).

4.2.2 Stand-by Mode

The stand-by mode is an idle mode of the TLE8251VSJ with optimized power consumption. In stand-by mode the transmitter and the normal-mode receiver are turned off. The TLE8251VSJ cannot send any data to the CAN bus nor receive any data from the CAN bus.

The low-power receiver is connected to the bus lines. Wake-up signals are indicated on the RxD output pin. An additional filter, implemented inside the low-power receiver, ensures that only dominant and recessive" signals on the CAN bus, which are longer than the CAN activity filter time t_{Filter} , are indicated at the RxD output pin (see [Figure 8](#)).

A logical "high" signal on the STB pin selects the stand-by mode, while the transceiver is supplied by the digital supply V_{IO} (see [Table 2](#) for details).

In stand-by mode the bus input pins are biased to GND via the receiver input resistors R_i.

Undervoltage detection on the transmitter supply V_{CC} is turned off, allowing to switch off the V_{CC} supply in stand-by mode.

Functional Description

4.3 Power-up and Undervoltage Condition

When detecting an undervoltage event, either on the transmitter supply V_{CC} or the digital supply V_{IO} , the transceiver TLE8251VSJ changes the mode of operation. Turning off the digital power supply V_{IO} , the transceiver powers down and remains in the power-down state. While switching off the transmitter supply V_{CC} , the transceiver either changes to the forced stand-by mode, or remains in stand-by mode (details see Figure 5).

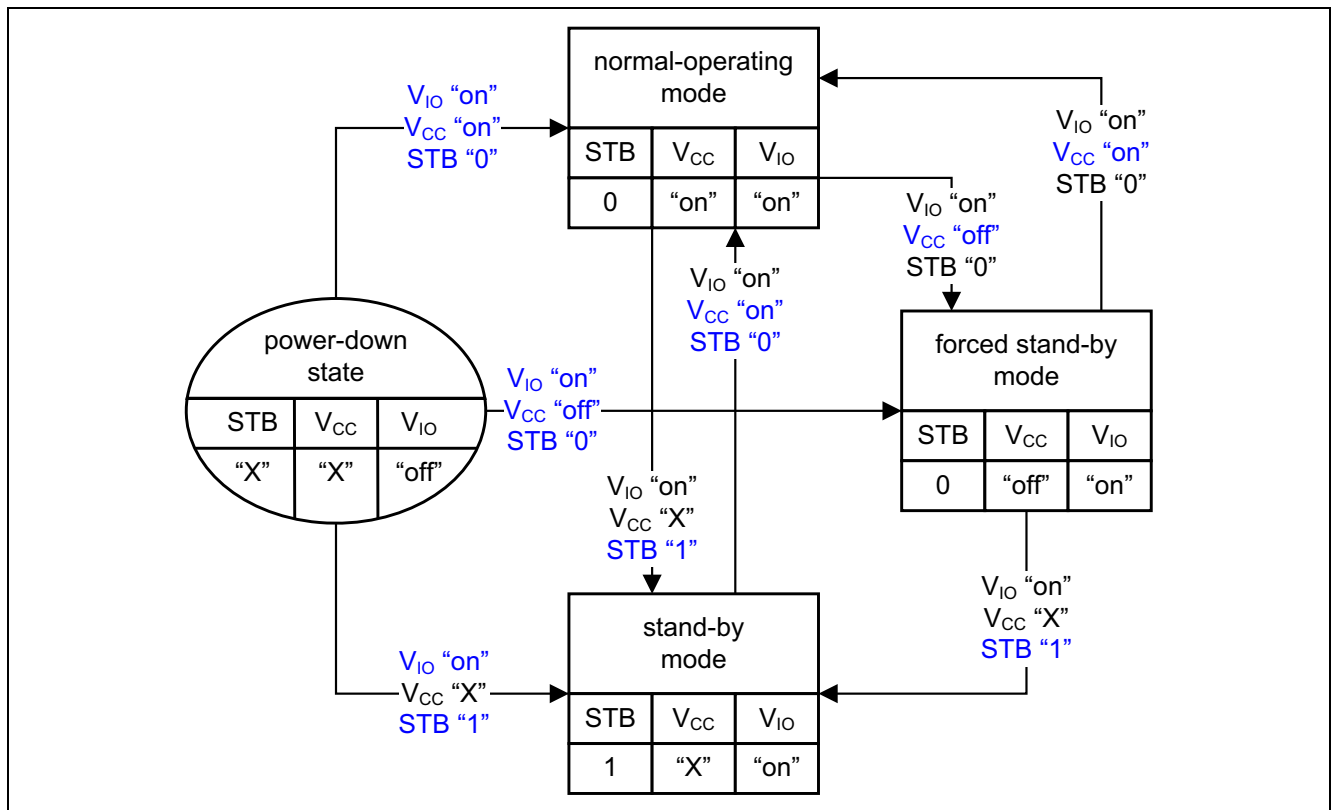

Figure 5 Power-up and undervoltage

Table 2 Modes of operation

| Mode | STB | V_{IO} | V_{CC} | Bus Bias | Transmitter | Normal-mode Receiver | Low-power Receiver |
|------------------|--------------------|----------|----------|------------|-------------|----------------------|--------------------|
| Normal-operating | "low" | "on" | "on" | $V_{CC}/2$ | "on" | "on" | "off" |
| Stand-by | "high" | "on" | "X" | GND | "off" | "off" | "on" |
| Forced stand-by | "low" | "on" | "off" | GND | "off" | "off" | "on" |
| Power-down state | "X ¹⁾ " | "off" | "X" | floating | "off" | "off" | "off" |

1) "X": Don't care

Functional Description

4.3.1 Power-down State

Independent of the transmitter supply V_{CC} and of the STB input pin, the TLE8251VSJ is in power-down state when the digital supply voltage V_{IO} is turned off (see [Figure 5](#)).

In power-down state the input resistors of the receiver are disconnected from the bus biasing $V_{CC}/2$. The CANH and CANL bus interface of the TLE8251VSJ is floating and acts as a high-impedance input with a very low leakage current. The high-ohmic input does not influence the recessive level of the CAN network and allows an optimized EME performance of the entire HS CAN network (see also [Table 2](#)).

4.3.2 Forced Stand-by Mode

The forced stand-by mode is a fail-safe mode to avoid any disturbance on the HS CAN bus during loss of the transmitter supply V_{CC} .

In forced stand-by mode, the transmitter and the normal-mode receiver are turned off and therefore the transceiver TLE8251VSJ can not disturb the bus media.

Similar to stand-by mode, the low-power receiver is connected to the bus lines and wake-up signals on the CAN bus are indicated at the RxD output pin (see [Figure 8](#)).

In forced stand-by mode the bus is also biased to GND (details see [Table 2](#)) via the receiver input resistors.

Forced stand-by mode can only be entered when the transmitter supply V_{CC} is not available, either by powering up the digital supply V_{IO} only or by turning off the transmitter supply in normal-operating mode. While the transceiver TLE8251VSJ is in forced stand-by mode, switching the STB input pin to logical “high” triggers a mode change to stand-by mode (see [Figure 5](#)).

4.3.3 Power-up

The HS CAN transceiver TLE8251VSJ powers up if at least the digital supply V_{IO} is connected to the device. By default the device powers up in stand-by mode, due to the internal pull-up resistor on the STB pin to V_{IO} .

In case the device is to power-up to normal-operating mode, the STB pin needs to be pulled active to logical “low” and the supplies V_{IO} and V_{CC} have to be connected.

By supplying only the digital power supply V_{IO} the TLE8251VSJ powers up either in forced stand-by mode or stand-by mode, depending on the signal of the STB input pin (see [Figure 5](#)).

Functional Description

4.3.4 Undervoltage on the Digital Supply V_{IO}

If the voltage on V_{IO} supply input falls below the threshold $V_{IO} < V_{IO(UV,F)}$, the transceiver TLE8251VSJ powers down and changes to power-down state.

Undervoltage detection on the digital supply V_{IO} has the highest priority. It is independent of the transmitter supply V_{CC} and also independent of the currently selected operating mode. Any undervoltage event on V_{IO} powers down the TLE8251VSJ.

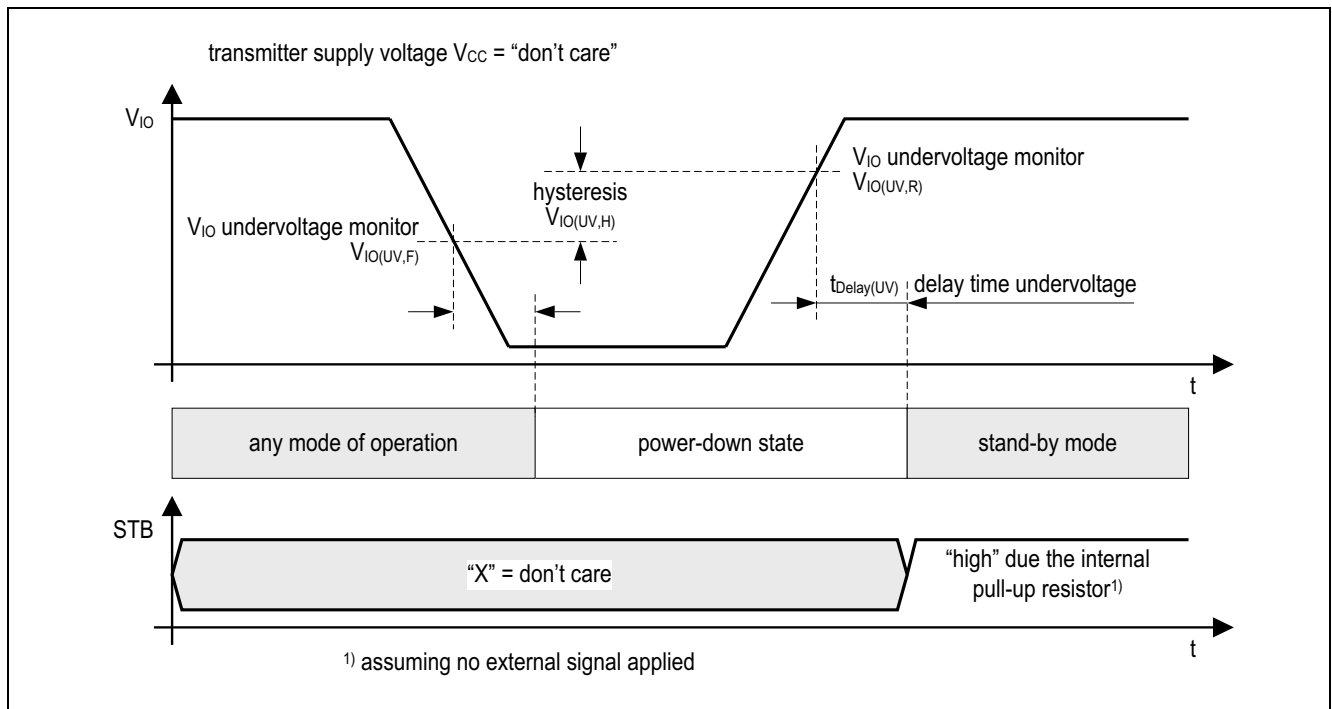

Figure 6 Undervoltage on the digital supply V_{IO}

Functional Description

4.3.5 Undervoltage on the Transmitter Supply V_{CC}

In case the transmitter supply V_{CC} falls below the threshold $V_{CC} < V_{CC(UV,F)}$, the transceiver TLE8251VSJ changes the mode of operation to forced stand-by mode. The transmitter and also the normal-mode receiver of the TLE8251VSJ are powered by the V_{CC} supply. In case of insufficient V_{CC} supply, the TLE8251VSJ can neither transmit the CANH and CANL signals correctly to the bus, nor can it receive them properly. Therefore the TLE8251VSJ blocks the transmitter and the receiver in forced stand-by mode. The low-power receiver is active in forced stand-by mode (see [Figure 7](#)).

Undervoltage detection on the transmitter supply V_{CC} is only active in normal-operating mode (see [Figure 5](#)).

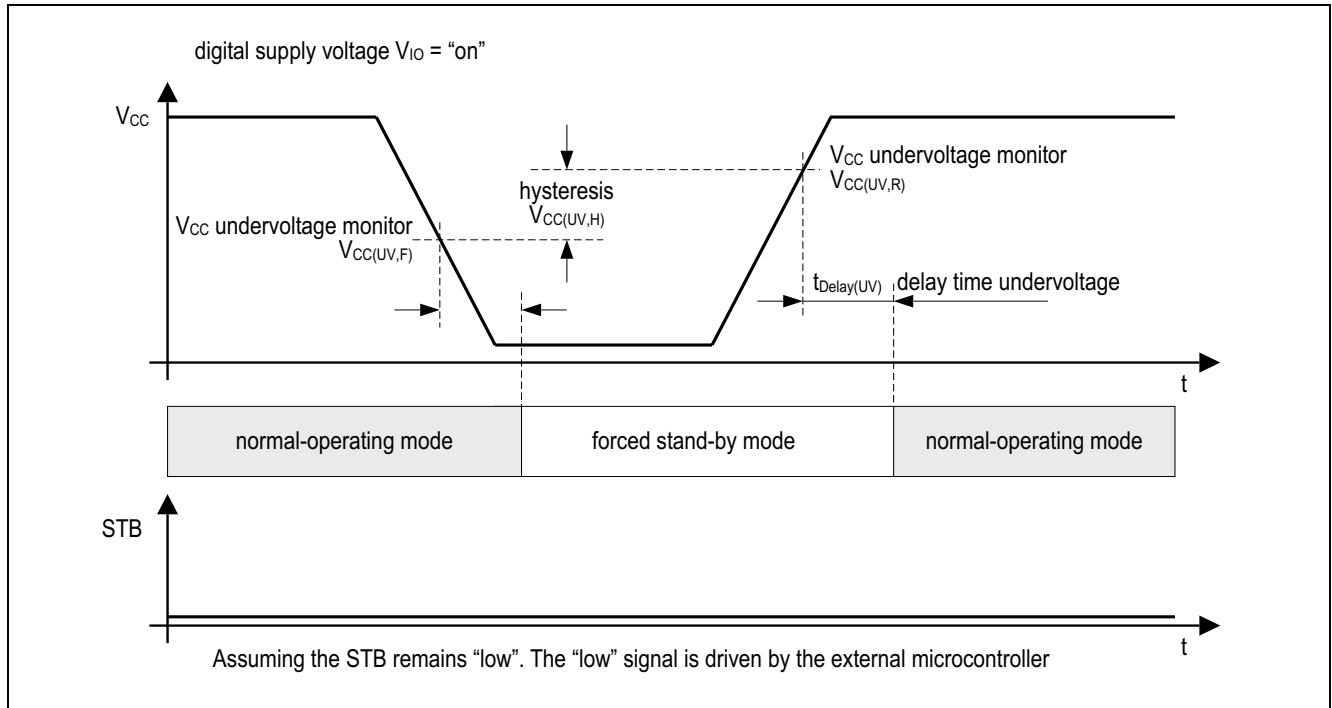

Figure 7 Undervoltage on the transmitter supply V_{CC}

4.3.6 Voltage Adaption to the Microcontroller Supply

The HS CAN transceiver TLE8251VSJ has two different power supplies, V_{CC} and V_{IO} . The power supply V_{CC} supplies the transmitter and the normal-mode receiver. The power supply V_{IO} supplies the digital input and output buffers, the low-power receiver and the wake-up logic. It is also the main power domain for the internal logic.

To adjust the digital input and output levels of the TLE8251VSJ to the I/O levels of the external microcontroller, connect the power supply V_{IO} to the microcontroller I/O supply voltage (see [Figure 14](#)).

Note: In case the digital supply voltage V_{IO} is not required in the application, connect the digital supply voltage V_{IO} to the transmitter supply V_{CC} .

Functional Description

4.4 Remote Wake-up

The TLE8251VSJ has a remote wake-up feature, also called bus wake-up feature. In both stand-by mode and forced stand-by mode, the low-power receiver monitors the activity on the CAN bus and in case it detects a wake-up signal, the TLE8251VSJ indicates the wake-up signal on the RxD output pin.

While entering stand-by mode, the RxD output pin is set to logical “high”, regardless of the signal on the CAN bus. The low-power receiver of the TLE8251VSJ requires a signal change from recessive to dominant on the CAN bus before the RxD output is enabled to follow the signals on the HS CAN bus.

HS CAN bus signals, dominant or recessive, with a pulse width above the CAN activity filter time $t > t_{Filter}$ are indicated on the RxD output pin. Glitches with a pulse width below the CAN activity filter time $t < t_{Filter}$ are ignored and not considered a valid wake-up signal. The RxD output reacts within the reaction time t_{WU_Rec} after detecting a wake-up signal (see [Figure 8](#)).

Note: A wake-up event on the CAN bus is only indicated on the RxD output, no automatic change of the operating mode is applied. To enter normal-operating mode, the external microcontroller needs to change the signal on the STB pin.

The wake-up logic is supplied by the power supply V_{IO} (see [Figure 1](#)). In case the TLE8251VSJ is in stand-by mode the power supply V_{CC} can be turned off, while the TLE8251VSJ is still able to detect a wake-up signal on the HS CAN bus (see also [Figure 4](#)).

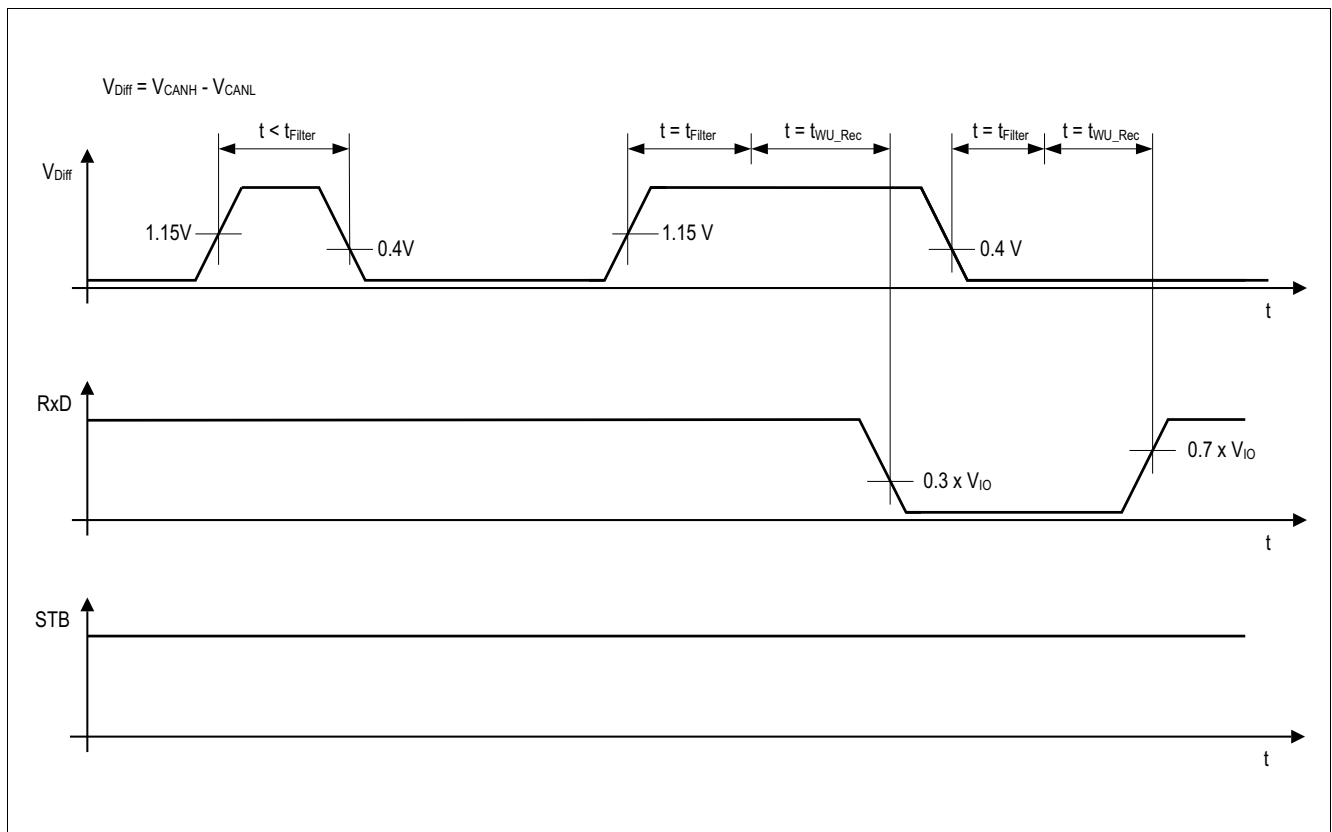

Figure 8 Wake-up pattern

5 Fail Safe Functions

5.1 Short Circuit Protection

The CANH and CANL bus outputs are short circuit proof, either against GND or a positive supply voltage. A current limiting circuit protects the transceiver against damage. If the device is heating up due to a continuous short on the CANH or CANL, the internal overtemperature protection switches off the bus transmitter.

5.2 Unconnected Logic Pins

All logic input pins have an internal pull-up resistor to V_{IO} . In case V_{IO} supply is activated and the logic pins are open, the TLE8251VSJ enters stand-by mode by default. In stand-by mode the transmitter of the TLE8251VSJ is disabled, the bus bias is turned off and the input resistors of CANH and CANL are connected to GND.

5.3 TxD Time-out Function

The TxD time-out feature protects the CAN bus against permanent blocking in case the logical signal on the TxD pin is continuously “low”. A continuous “low” signal on the TxD pin might have its root cause in a locked-up microcontroller or in a short circuit on the printed circuit board, for example. In normal-operating mode, a logical “low” signal on the TxD pin for the time $t > t_{TxD}$ enables the TxD time-out feature and the TLE8251VSJ disables the transmitter (see [Figure 9](#)). The receiver is still active and the the RxD output continues monitoring data on the bus.

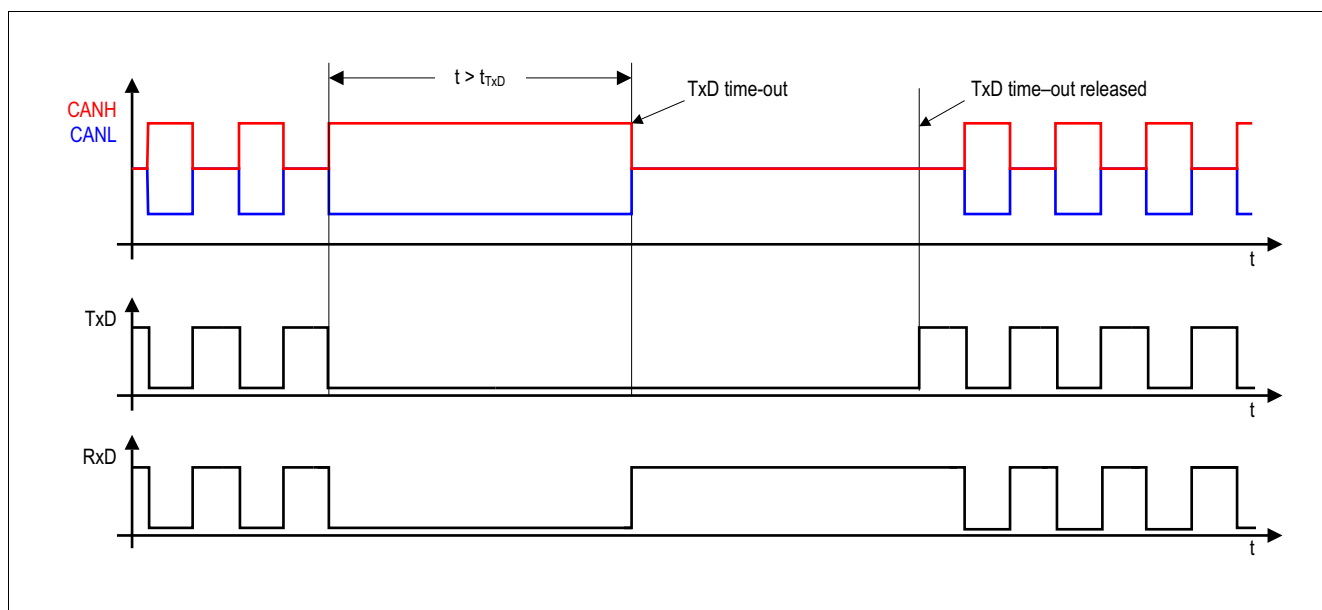

Figure 9 TxD time-out function

[Figure 9](#) illustrates how the transmitter is deactivated and activated again. A permanent “low” signal on the TxD input pin activates the TxD time-out function and deactivates the transmitter. To release the transmitter after a TxD time-out event the TLE8251VSJ requires a signal change on the TxD input pin from logical “low” to logical “high”.

Fail Safe Functions

5.4 Overtemperature Protection

The integrated overtemperature detection protects the TLE8251VSJ against thermal overstress of the transmitter. Overtemperature protection is active in normal-operating mode and disabled in stand-by mode. In overtemperature condition, the temperature sensor disables the transmitter (see [Figure 1](#)) while the transceiver remains in normal-operating mode.

After the device has cooled down the transmitter is activated again (see [Figure 10](#)). A hysteresis is implemented within the temperature sensor.

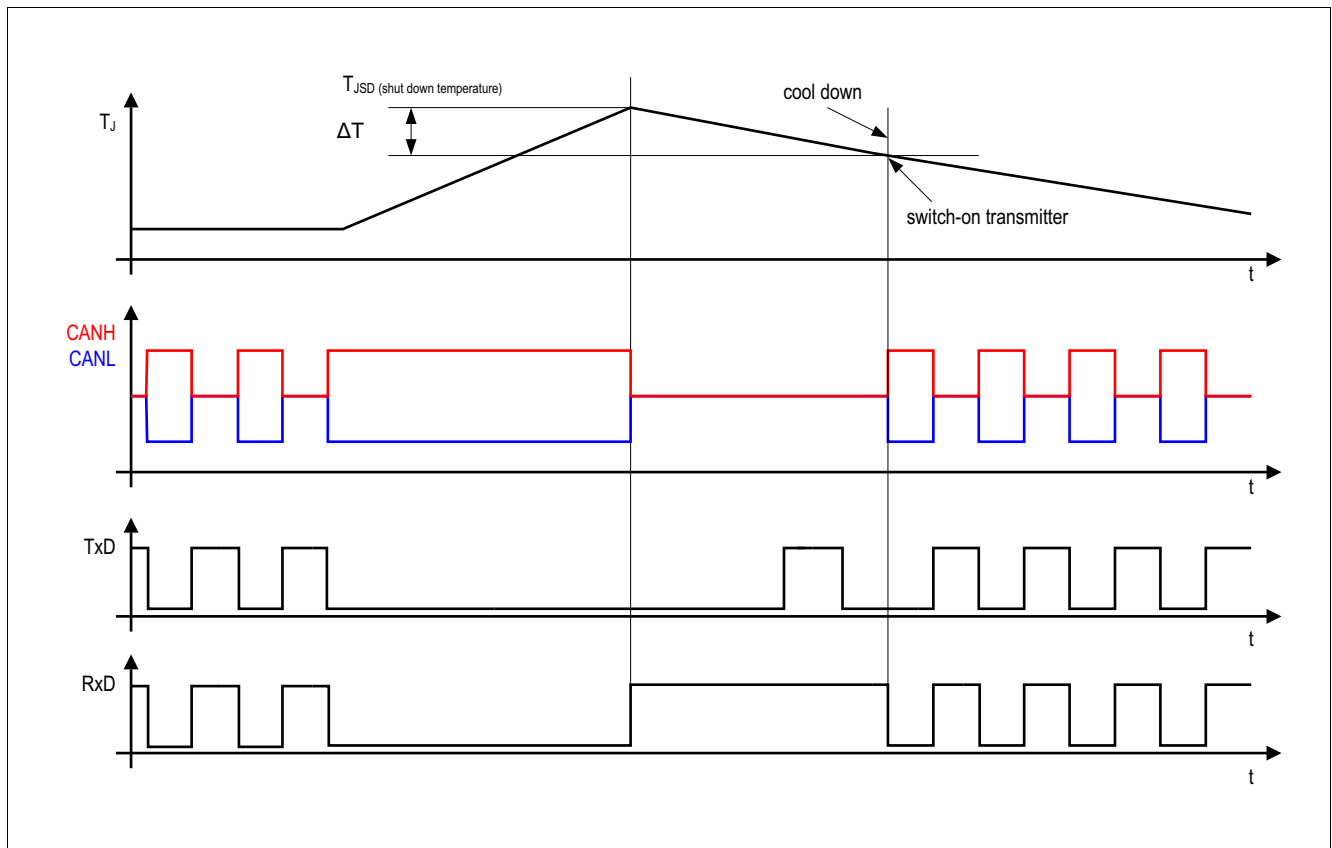

Figure 10 Overtemperature protection

5.5 Delay Time for Mode Change

The HS CAN transceiver TLE8251VSJ changes the mode of operation within the time window t_{Mode} . During the mode change the RxD output pin is permanently set to logical “high” and does not reflect the status on the CANH and CANL input pins.

While changing the mode of operation from normal-operating mode to stand-by mode, the transceiver TLE8251VSJ turns off the transmitter and switches from the normal-mode receiver to the low-power receiver. After the mode change is completed, the transceiver TLE8251VSJ releases the RxD output pin (see as an example [Figure 16](#) and [Figure 17](#)).

6 General Product Characteristics

6.1 Absolute Maximum Ratings

Table 3 Absolute maximum ratings voltages, currents and temperatures¹⁾

All voltages with respect to ground; positive current flowing into pin;
(unless otherwise specified)

| Parameter | Symbol | Values | | | Unit | Note or Test Condition | Number |
|--|---------------------|--------|------|----------|------|---------------------------------------|----------|
| | | Min. | Typ. | Max. | | | |
| Voltages | | | | | | | |
| Transmitter supply voltage | V_{CC} | -0.3 | - | 6.0 | V | - | P_6.1.1 |
| Digital supply voltage | V_{IO} | -0.3 | - | 6.0 | V | - | P_6.1.2 |
| CANH DC voltage versus GND | V_{CANH} | -40 | - | 40 | V | - | P_6.1.3 |
| CANL DC voltage versus GND | V_{CANL} | -40 | - | 40 | V | - | P_6.1.4 |
| Differential voltage between CANH and CANL | V_{CAN_Diff} | -40 | - | 40 | V | - | P_6.1.5 |
| Voltages at the input pins: STB, TxD | V_{MAX_IN} | -0.3 | - | 6.0 | V | - | P_6.1.6 |
| Voltages at the output pin: RxD | V_{MAX_OUT} | -0.3 | - | V_{IO} | V | - | P_6.1.7 |
| Currents | | | | | | | |
| RxD output current | I_{RxD} | -20 | - | 20 | mA | - | P_6.1.8 |
| Temperatures | | | | | | | |
| Junction temperature | T_j | -40 | - | 150 | °C | - | P_6.1.9 |
| Storage temperature | T_S | -55 | - | 150 | °C | - | P_6.1.10 |
| ESD Resistivity | | | | | | | |
| ESD immunity at CANH, CANL versus GND | $V_{ESD_HBM_CAN}$ | -10 | - | 10 | kV | HBM (100 pF via 1.5 kΩ) ²⁾ | P_6.1.11 |
| ESD immunity at all other pins | $V_{ESD_HBM_ALL}$ | -2 | - | 2 | kV | HBM (100 pF via 1.5 kΩ) ²⁾ | P_6.1.12 |
| ESD immunity to GND | V_{ESD_CDM} | -750 | - | 750 | V | CDM ³⁾ | P_6.1.13 |

1) Not subject to production test, specified by design

2) ESD susceptibility, Human Body Model "HBM" according to ANSI/ESDA/JEDEC JS-001

3) ESD susceptibility, Charge Device Model "CDM" according to EIA/JESD22-C101 or ESDA STM5.3.1

Note: Stresses above the ones listed here may cause permanent damage to the device. Exposure to absolute maximum rating conditions for extended periods may affect device reliability. Integrated protection functions are designed to prevent IC destruction under fault conditions described in the data sheet. Fault conditions are considered as "outside" normal-operating range. Protection functions are not designed for continuous repetitive operation.

General Product Characteristics

6.2 Functional Range

Table 4 Functional range

| Parameter | Symbol | Values | | | Unit | Note or Test Condition | Number |
|----------------------------|----------|--------|------|------|------|------------------------|---------|
| | | Min. | Typ. | Max. | | | |
| Supply Voltages | | | | | | | |
| Transmitter supply voltage | V_{CC} | 4.5 | – | 5.5 | V | – | P_6.2.1 |
| Digital supply voltage | V_{IO} | 3.0 | – | 5.5 | V | – | P_6.2.2 |
| Thermal Parameters | | | | | | | |
| Junction temperature | T_j | -40 | – | 150 | °C | ¹⁾ | P_6.2.3 |

1) Not subject to production test, specified by design.

Note: Within the functional range the IC operates as described in the circuit description. The electrical characteristics are specified within the conditions given in the related electrical characteristics table.

6.3 Thermal Resistance

Note: This thermal data was generated in accordance with JEDEC JESD51 standards. For more information, please visit www.jedec.org.

Table 5 Thermal resistance¹⁾

| Parameter | Symbol | Values | | | Unit | Note or Test Condition | Number |
|--|------------|--------|------|------|------|--------------------------|---------|
| | | Min. | Typ. | Max. | | | |
| Thermal Resistances | | | | | | | |
| Junction to Ambient PG-DSO-8 | R_{thJA} | – | 130 | – | K/W | ²⁾ TLE8251VSJ | P_6.3.1 |
| Thermal Shutdown (junction temperature) | | | | | | | |
| Thermal shutdown temperature | T_{JSD} | 150 | 175 | 200 | °C | – | P_6.3.2 |
| Thermal shutdown hysteresis | ΔT | – | 10 | – | K | – | P_6.3.3 |

1) Not subject to production test, specified by design

2) Specified R_{thJA} value is according to Jedec JESD51-2,-7 at natural convection on FR4 2s2p board. The product (TLE8251VSJ) was simulated on a 76.2 x 114.3 x 1.5 mm board with 2 inner copper layers (2 x 70µm Cu, 2 x 35µm Cu).

Electrical Characteristics

7 Electrical Characteristics

7.1 Functional Device Characteristics

Table 6 Electrical characteristics

4.5 V < V_{CC} < 5.5 V; 3.0 V < V_{IO} < 5.5 V; $R_L = 60 \Omega$; $-40^\circ\text{C} < T_j < 150^\circ\text{C}$; all voltages with respect to ground; positive current flowing into pin; unless otherwise specified.

| Parameter | Symbol | Values | | | Unit | Note or Test Condition | Number |
|---|------------------------|--------|------|------|---------------|---|----------|
| | | Min. | Typ. | Max. | | | |
| Current Consumption | | | | | | | |
| Current consumption at V_{CC} normal-operating mode | I_{CC} | – | 2.6 | 4 | mA | recessive state, $V_{TXD} = V_{IO}, V_{STB} = 0\text{ V}$; | P_7.1.1 |
| Current consumption at V_{CC} normal-operating mode | I_{CC} | – | 38 | 60 | mA | dominant state, $V_{TXD} = V_{STB} = 0\text{ V}$; | P_7.1.2 |
| Current consumption at V_{IO} normal-operating mode | I_{IO} | – | – | 1 | mA | $V_{STB} = 0\text{ V}$; | P_7.1.3 |
| Current consumption at V_{CC} stand-by mode | $I_{CC(STB)}$ | – | – | 5 | μA | $V_{TXD} = V_{STB} = V_{IO}$; | P_7.1.4 |
| Current consumption at V_{IO} stand-by mode | $I_{IO(STB)}$ | – | 8 | 14 | μA | $V_{TXD} = V_{STB} = V_{IO}$, $0\text{ V} < V_{CC} < 5.5\text{ V}$; | P_7.1.5 |
| Current consumption at V_{IO} stand-by mode @ 105°C | $I_{IO(STB)_105}$ | – | 6 | 12.5 | μA | $V_{TXD} = V_{STB} = V_{IO}$, $0\text{ V} < V_{CC} < 5.5\text{ V}$, $T < 105^\circ\text{C}$; | P_7.1.6 |
| Supply Resets | | | | | | | |
| V_{CC} undervoltage monitor rising edge | $V_{CC(UV,R)}$ | 3.8 | 4.0 | 4.3 | V | – | P_7.1.7 |
| V_{CC} undervoltage monitor falling edge | $V_{CC(UV,F)}$ | 3.65 | 3.85 | 4.3 | V | – | P_7.1.8 |
| V_{CC} undervoltage monitor hysteresis | $V_{CC(UV,H)}$ | – | 150 | – | mV | ¹⁾ | P_7.1.9 |
| V_{IO} undervoltage monitor rising edge | $V_{IO(UV,R)}$ | 2.0 | 2.5 | 3.0 | V | – | P_7.1.10 |
| V_{IO} undervoltage monitor falling edge | $V_{IO(UV,F)}$ | 1.8 | 2.3 | 3.0 | V | – | P_7.1.11 |
| V_{IO} undervoltage monitor hysteresis | $V_{IO(UV,H)}$ | – | 200 | – | mV | ¹⁾ | P_7.1.12 |
| V_{CC} and V_{IO} undervoltage delay time, rising edge | $t_{\text{Delay(UV)}}$ | – | – | 100 | μs | ¹⁾ (see Figure 6 and Figure 7); | P_7.1.13 |

Electrical Characteristics

Table 6 Electrical characteristics (cont'd)

4.5 V < V_{CC} < 5.5 V; 3.0 V < V_{IO} < 5.5 V; $R_L = 60 \Omega$; $-40 \text{ }^\circ\text{C} < T_j < 150 \text{ }^\circ\text{C}$; all voltages with respect to ground; positive current flowing into pin; unless otherwise specified.

| Parameter | Symbol | Values | | | Unit | Note or Test Condition | Number |
|---|----------------------|------------------------|------------------------|------------------------|------------|--|----------|
| | | Min. | Typ. | Max. | | | |
| Receiver Output RxD | | | | | | | |
| “High” level output current | $I_{RD,H}$ | – | -4 | -2 | mA | $V_{RxD} = V_{IO} - 0.4 \text{ V}$, $V_{Diff} < 0.5 \text{ V}$; | P_7.1.14 |
| “Low” level output current | $I_{RD,L}$ | 2 | 4 | – | mA | $V_{RxD} = 0.4 \text{ V}$, $V_{Diff} > 0.9 \text{ V}$; | P_7.1.15 |
| Transmission Input TxD | | | | | | | |
| “High” level input voltage threshold | $V_{TxD,H}$ | – | 0.5 $\times V_{IO}$ | 0.7 $\times V_{IO}$ | V | recessive state; | P_7.1.16 |
| “Low” level input voltage threshold | $V_{TxD,L}$ | 0.3 $\times V_{IO}$ | 0.4 $\times V_{IO}$ | – | V | dominant state; | P_7.1.17 |
| Pull-up resistance | R_{TxD} | 10 | 25 | 50 | k Ω | – | P_7.1.18 |
| Input hysteresis | $V_{HYS(TxD)}$ | – | 450 | – | mV | ¹⁾ | P_7.1.19 |
| Input capacitance | C_{TxD} | – | – | 10 | pF | ¹⁾ | P_7.1.20 |
| TxD permanent dominant time-out | t_{TxD} | 4.5 | – | 16 | ms | normal-operating mode; | P_7.1.21 |
| Stand-by Input STB | | | | | | | |
| “High” level input voltage threshold | $V_{STB,H}$ | – | 0.5 $\times V_{IO}$ | 0.7 $\times V_{IO}$ | V | stand-by mode; | P_7.1.22 |
| “Low” level input voltage threshold | $V_{STB,L}$ | 0.3 $\times V_{IO}$ | 0.4 $\times V_{IO}$ | – | V | normal-operating mode; | P_7.1.23 |
| Pull-up resistance | R_{STB} | 10 | 25 | 50 | k Ω | – | P_7.1.24 |
| Input capacitance | C_{STB} | – | – | 10 | pF | ¹⁾ | P_7.1.25 |
| Input hysteresis | $V_{HYS(STB)}$ | – | 200 | – | mV | ¹⁾ | P_7.1.26 |
| Bus Receiver | | | | | | | |
| Differential receiver threshold dominant normal-operating mode | V_{Diff_D} | – | 0.75 | 0.9 | V | ²⁾ | P_7.1.27 |
| Differential receiver threshold recessive normal-operating mode | V_{Diff_R} | 0.5 | 0.66 | – | V | ²⁾ | P_7.1.28 |
| Differential range dominant normal-operating mode | $V_{Diff_D_Range}$ | 0.9 | – | 8.0 | V | ^{1) 2)} | P_7.1.29 |
| Differential range recessive normal-operating mode | $V_{Diff_R_Range}$ | -3.0 | – | 0.5 | V | ^{1) 2)} | P_7.1.30 |
| Differential receiver threshold dominant stand-by mode | $V_{Diff_D_STB}$ | – | 0.75 | 1.15 | V | ²⁾ | P_7.1.31 |

Electrical Characteristics

Table 6 Electrical characteristics (cont'd)

4.5 V < V_{CC} < 5.5 V; 3.0 V < V_{IO} < 5.5 V; $R_L = 60 \Omega$; $-40 \text{ }^\circ\text{C} < T_j < 150 \text{ }^\circ\text{C}$; all voltages with respect to ground; positive current flowing into pin; unless otherwise specified.

| Parameter | Symbol | Values | | | Unit | Note or Test Condition | Number |
|---|----------------------------------|--------|------|------|------------|--|----------|
| | | Min. | Typ. | Max. | | | |
| Differential receiver threshold recessive stand-by mode | $V_{\text{Diff_R_STB}}$ | 0.4 | 0.72 | – | V | ²⁾ | P_7.1.32 |
| Differential range dominant Stand-by mode | $V_{\text{Diff_D_Range_STB}}$ | 1.15 | – | 8.0 | V | ¹⁾²⁾ | P_7.1.33 |
| Differential range recessive Stand-by mode | $V_{\text{Diff_R_Range_STB}}$ | -3.0 | – | 0.4 | V | ¹⁾²⁾ | P_7.1.34 |
| Common mode range | CMR | -12 | – | 12 | V | $V_{CC} = 5 \text{ V}$; | P_7.1.35 |
| Differential receiver hysteresis normal-operating mode | $V_{\text{Diff,hys}}$ | – | 90 | – | mV | ¹⁾ | P_7.1.36 |
| CANH, CANL input resistance | R_i | 10 | 20 | 30 | k Ω | recessive state; | P_7.1.37 |
| Differential input resistance | R_{Diff} | 20 | 40 | 60 | k Ω | recessive state; | P_7.1.38 |
| Input resistance deviation between CANH and CANL | ΔR_i | -1 | – | 1 | % | ¹⁾ recessive state; | P_7.1.39 |
| Input capacitance CANH, CANL versus GND | C_{In} | – | 20 | 40 | pF | ¹⁾ $V_{\text{TXD}} = V_{\text{IO}}$; | P_7.1.40 |
| Differential input capacitance | $C_{\text{In_Diff}}$ | – | 10 | 20 | pF | ¹⁾ $V_{\text{TXD}} = V_{\text{IO}}$; | P_7.1.41 |

Bus Transmitter

| | | | | | | | |
|--|--------------------------|------|-----|------|----|---|----------|
| CANL/CANH recessive output voltage normal-operating mode | $V_{\text{CANL/H_R}}$ | 2.0 | 2.5 | 3.0 | V | $V_{\text{TXD}} = V_{\text{IO}}$, no load; | P_7.1.42 |
| CANH, CANL recessive output voltage difference normal-operating mode | $V_{\text{Diff_NM}}$ | -500 | – | 50 | mV | $V_{\text{TXD}} = V_{\text{IO}}$, no load; | P_7.1.43 |
| CANH, CANL recessive output voltage stand-by mode | $V_{\text{CANL,H_STB}}$ | -0.1 | – | 0.1 | V | no load; | P_7.1.44 |
| CANH, CANL recessive output voltage difference stand-by mode | $V_{\text{Diff_STB}}$ | -0.2 | – | 0.2 | V | no load; | P_7.1.45 |
| CANL dominant output voltage normal-operating mode | V_{CANL} | 0.5 | – | 2.25 | V | $V_{\text{TXD}} = 0 \text{ V}$; | P_7.1.46 |
| CANH dominant output voltage normal-operating mode | V_{CANH} | 2.75 | – | 4.5 | V | $V_{\text{TXD}} = 0 \text{ V}$; | P_7.1.47 |

Electrical Characteristics

Table 6 Electrical characteristics (cont'd)

4.5 V < V_{CC} < 5.5 V; 3.0 V < V_{IO} < 5.5 V; $R_L = 60 \Omega$; $-40 \text{ }^\circ\text{C} < T_j < 150 \text{ }^\circ\text{C}$; all voltages with respect to ground; positive current flowing into pin; unless otherwise specified.

| Parameter | Symbol | Values | | | Unit | Note or Test Condition | Number |
|--|------------------|--------|------|------|---------------|--|----------|
| | | Min. | Typ. | Max. | | | |
| CANH, CANL dominant output voltage difference normal-operating mode according to ISO 11898-2 $V_{Diff} = V_{CANH} - V_{CANL}$ | V_{Diff} | 1.5 | - | 3.0 | V | $V_{TXD} = 0 \text{ V}$, $50 \Omega < R_L < 65 \Omega$, $4.75 < V_{CC} < 5.25 \text{ V}$; | P_7.1.48 |
| CANH, CANL dominant output voltage difference normal-operating mode $V_{Diff} = V_{CANH} - V_{CANL}$ | V_{Diff_EXT} | 1.4 | - | 3.3 | V | $V_{TXD} = 0 \text{ V}$, $45 \Omega < R_L < 70 \Omega$, $4.75 < V_{CC} < 5.25 \text{ V}$; | P_7.1.49 |
| CANH, CANL dominant output voltage difference normal-operating mode $V_{Diff} = V_{CANH} - V_{CANL}$ | V_{Diff_HEXT} | 1.5 | - | 5 | V | $V_{TXD} = 0 \text{ V}$, static behavior, $R_L = 2240 \Omega$, $4.75 < V_{CC} < 5.25 \text{ V}^{(1)}$; | P_7.1.50 |
| Driver dominant symmetry normal-operating mode $V_{SYM} = V_{CANH} + V_{CANL}$ | V_{SYM} | 4.5 | 5 | 5.5 | V | $V_{CC} = 5.0 \text{ V}$, $V_{TXD} = 0 \text{ V}$; | P_7.1.51 |
| CANL short circuit current | I_{CANLsc} | 40 | 75 | 100 | mA | $V_{CANLshort} = 18 \text{ V}$, $V_{CC} = 5.0 \text{ V}$, $t < t_{TXD}$, $V_{TXD} = 0 \text{ V}$; | P_7.1.52 |
| CANH short circuit current | I_{CANHsc} | -100 | -75 | -40 | mA | $V_{CANHshort} = -3 \text{ V}$, $V_{CC} = 5.0 \text{ V}$, $t < t_{TXD}$, $V_{TXD} = 0 \text{ V}$; | P_7.1.53 |
| Leakage current, CANH | $I_{CANH,lk}$ | -5 | - | 5 | μA | $V_{CC} = V_{IO} = 0 \text{ V}$, $0 \text{ V} < V_{CANH} < 5 \text{ V}$, $V_{CANH} = V_{CANL}$; | P_7.1.54 |
| Leakage current, CANL | $I_{CANL,lk}$ | -5 | - | 5 | μA | $V_{CC} = V_{IO} = 0 \text{ V}$, $0 \text{ V} < V_{CANL} < 5 \text{ V}$, $V_{CANH} = V_{CANL}$; | P_7.1.55 |

Electrical Characteristics

Table 6 Electrical characteristics (cont'd)

4.5 V < V_{CC} < 5.5 V; 3.0 V < V_{IO} < 5.5 V; R_L = 60 Ω; -40 °C < T_j < 150 °C; all voltages with respect to ground; positive current flowing into pin; unless otherwise specified.

| Parameter | Symbol | Values | | | Unit | Note or Test Condition | Number |
|--|----------------------|--------|------|------|------|---|----------|
| | | Min. | Typ. | Max. | | | |
| Dynamic CAN-Transceiver Characteristics | | | | | | | |
| Propagation delay TxD-to-RxD “low” (“recessive to dominant) | t _{d(L),TR} | – | 170 | 230 | ns | C _L = 100 pF, 4.75 V < V _{CC} < 5.25 V, C = 15 pF; | P_7.1.56 |
| Propagation delay TxD-to-RxD “high” (dominant to recessive) | t _{d(H),TR} | – | 170 | 230 | ns | C _L = 100 pF, 4.75 V < V _{CC} < 5.25 V, C _{RxD} = 15 pF; | P_7.1.57 |
| Propagation delay TxD “low” to bus dominant | t _{d(L),T} | – | 90 | 140 | ns | C _L = 100 pF, 4.75 V < V _{CC} < 5.25 V, C _{RxD} = 15 pF; | P_7.1.58 |
| Propagation delay TxD “high” to bus recessive | t _{d(H),T} | – | 90 | 140 | ns | C _L = 100 pF, 4.75 V < V _{CC} < 5.25 V, C _{RxD} = 15 pF; | P_7.1.59 |
| Propagation delay bus dominant to RxD “low” | t _{d(L),R} | – | 90 | 140 | ns | C _L = 100 pF, 4.75 V < V _{CC} < 5.25 V, C _{RxD} = 15 pF; | P_7.1.60 |
| Propagation delay bus recessive to RxD “high” | t _{d(H),R} | – | 90 | 140 | ns | C _L = 100 pF, 4.75 V < V _{CC} < 5.25 V, C _{RxD} = 15 pF; | P_7.1.61 |
| Delay Times | | | | | | | |
| Delay time for mode change | t _{Mode} | – | – | 20 | μs | ¹⁾ (see Figure 16); | P_7.1.62 |
| RxD reaction delay, stand-by mode to normal- operating mode, | t _{RxD_Rec} | – | – | 5 | μs | ¹⁾ (see Figure 17); | P_7.1.63 |
| CAN activity filter time | t _{Filter} | 0.5 | – | 5 | μs | (see Figure 8); | P_7.1.64 |
| Wake-up reaction time | t _{WU_Rec} | – | – | 5 | μs | ¹⁾ (see Figure 8); | P_7.1.65 |

Electrical Characteristics

Table 6 Electrical characteristics (cont'd)

4.5 V < V_{CC} < 5.5 V; 3.0 V < V_{IO} < 5.5 V; R_L = 60 Ω; -40 °C < T_j < 150 °C; all voltages with respect to ground; positive current flowing into pin; unless otherwise specified.

| Parameter | Symbol | Values | | | Unit | Note or Test Condition | Number |
|---|---------------------------|--------|------|------|------|--|----------|
| | | Min. | Typ. | Max. | | | |
| CAN FD Characteristics - | | | | | | | |
| Received recessive bit width at 2 MBit/s | t _{Bit(RxD)_2MB} | 430 | 500 | 530 | ns | C _L = 100 pF, 4.75 V < V _{CC} < 5.25 V, C _{RxD} = 15 pF, t _{Bit} = 500 ns, (see Figure 13); | P_7.1.66 |
| Transmitted recessive bit width at 2 MBit/s | t _{Bit(Bus)_2MB} | 450 | 500 | 530 | ns | C _L = 100 pF, 4.75 V < V _{CC} < 5.25 V, C _{RxD} = 15 pF, t _{Bit} = 500 ns, (see Figure 13); | P_7.1.67 |
| Receiver timing symmetry at 2 MBit/s Δt _{Rec} = t _{Bit(RxD)} - t _{Bit(Bus)} | Δt _{Rec_2MB} | -45 | - | 20 | ns | C _L = 100 pF, 4.75 V < V _{CC} < 5.25 V, C _{RxD} = 15 pF, t _{Bit} = 500 ns, (see Figure 13); | P_7.1.68 |

- 1) Not subject to production test, specified by design.
- 2) In respect to common mode range.

Electrical Characteristics

7.2 Diagrams

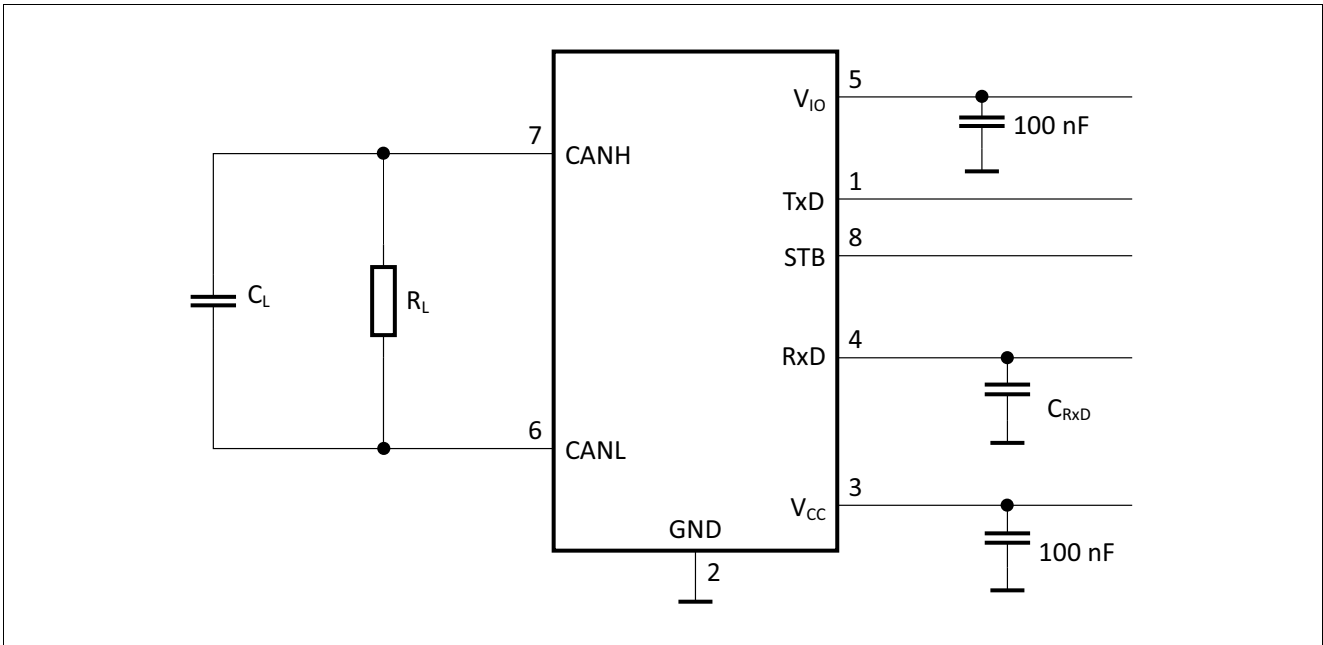

Figure 11 Test circuits for dynamic characteristics

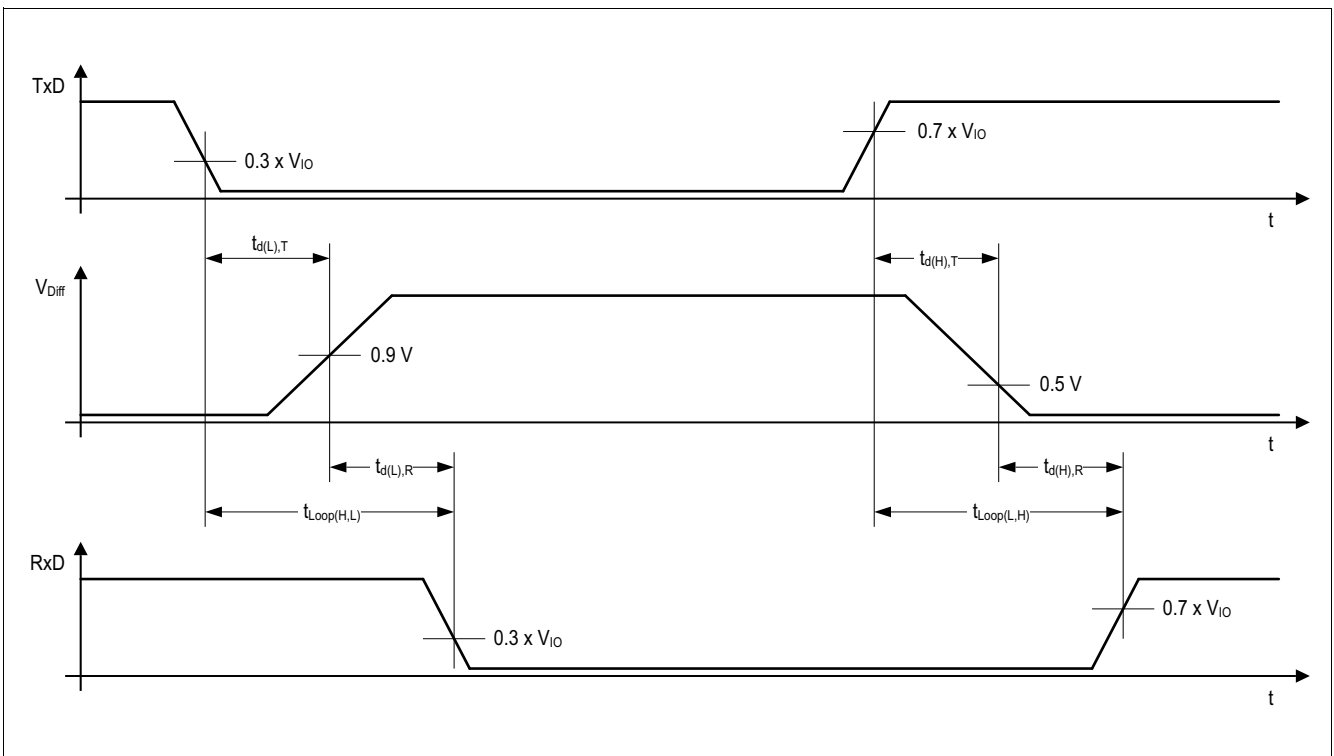

Figure 12 Timing diagrams for dynamic characteristics

Electrical Characteristics

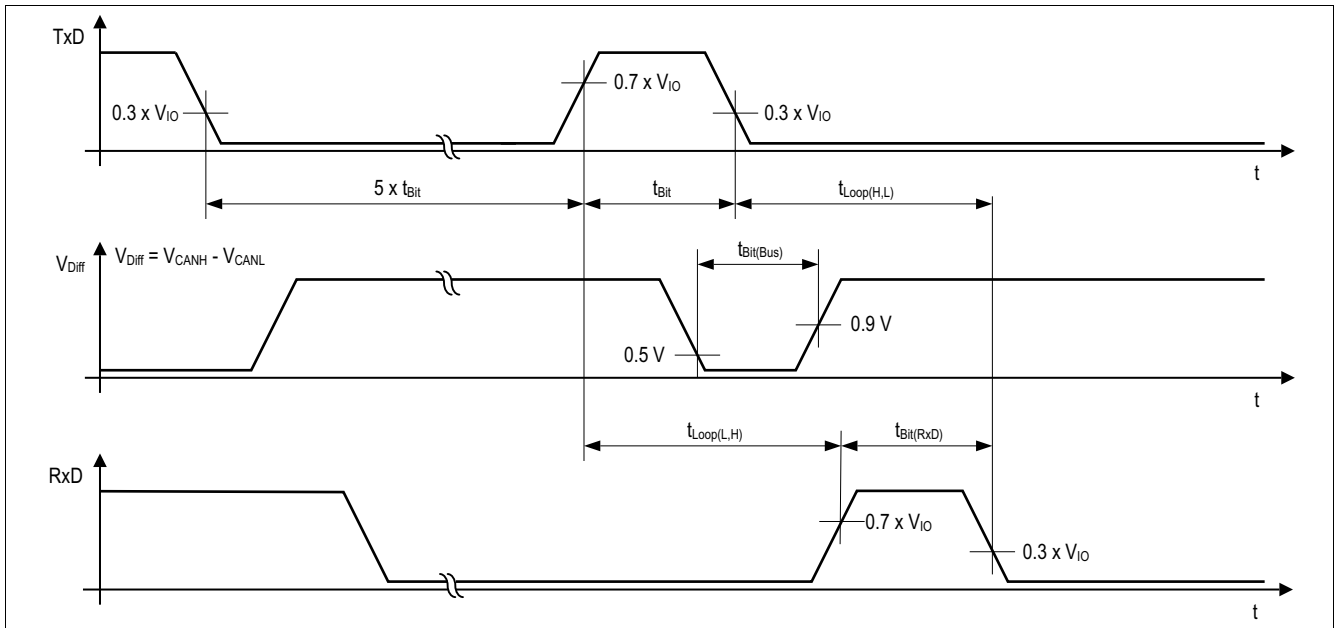

Figure 13 Recessive bit time - five dominant bits followed by one recessive bit