



Chipsmall Limited consists of a professional team with an average of over 10 year of expertise in the distribution of electronic components. Based in Hongkong, we have already established firm and mutual-benefit business relationships with customers from,Europe,America and south Asia,supplying obsolete and hard-to-find components to meet their specific needs.

With the principle of “Quality Parts,Customers Priority,Honest Operation,and Considerate Service”,our business mainly focus on the distribution of electronic components. Line cards we deal with include Microchip,ALPS,ROHM,Xilinx,Pulse,ON,Everlight and Freescale. Main products comprise IC,Modules,Potentiometer,IC Socket,Relay,Connector.Our parts cover such applications as commercial,industrial, and automotives areas.

We are looking forward to setting up business relationship with you and hope to provide you with the best service and solution. Let us make a better world for our industry!



## Contact us

Tel: +86-755-8981 8866 Fax: +86-755-8427 6832

Email & Skype: info@chipsmall.com Web: www.chipsmall.com

Address: A1208, Overseas Decoration Building, #122 Zhenhua RD., Futian, Shenzhen, China





## Low Current LED in Ø 3 mm Tinted Diffused Package

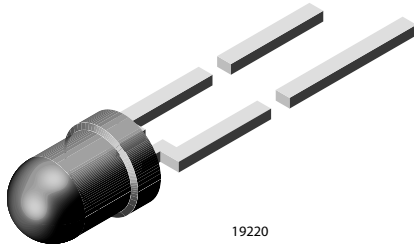

### PRODUCT GROUP AND PACKAGE DATA

- Product group: LED
- Package: 3 mm
- Product series: low current
- Angle of half intensity:  $\pm 25^\circ$

### FEATURES

- Low power consumption
- High brightness
- CMOS / MOS compatible
- Specified at  $I_F = 2$  mA
- Luminous intensity categorized
- Yellow and green color categorized
- Material categorization:  
for definitions of compliance please see [www.vishay.com/doc?99912](http://www.vishay.com/doc?99912)



**RoHS**  
COMPLIANT  
HALOGEN  
**FREE**  
**GREEN**  
(5-2008)

### APPLICATIONS

- Low power DC circuits

PARTS TABLE														
PART	COLOR	LUMINOUS INTENSITY (mcd)			at $I_F$ (mA)	WAVELENGTH (nm)			at $I_F$ (mA)	FORWARD VOLTAGE (V)			at $I_F$ (mA)	TECHNOLOGY
		MIN.	TYP.	MAX.		MIN.	TYP.	MAX.		MIN.	TYP.	MAX.		
TLLR4400	Red	0.63	1.2	-	2	612	-	625	2	-	1.9	2.4	2	GaAsP on GaP
TLLR4400-AS12Z	Red	0.63	1.2	-	2	612	-	625	2	-	1.9	2.4	2	GaAsP on GaP
TLLR4401	Red	1	2	-	2	612	-	625	2	-	1.9	2.4	2	GaAsP on GaP
TLLR4401-AS12	Red	1	2	-	2	612	-	625	2	-	1.9	2.4	2	GaAsP on GaP
TLLR4401-AS12Z	Red	1	2	-	2	612	-	625	2	-	1.9	2.4	2	GaAsP on GaP
TLLY4400	Yellow	0.63	1.2	-	2	581	-	594	2	-	2.4	2.9	2	GaAsP on GaP
TLLY4400-MS12	Yellow	0.63	1.2	-	2	581	-	594	2	-	2.4	2.9	2	GaAsP on GaP
TLLY4401	Yellow	1	2	-	2	581	-	594	2	-	2.4	2.9	2	GaAsP on GaP
TLLY4401-AS12	Yellow	1	2	-	2	581	-	594	2	-	2.4	2.9	2	GaAsP on GaP
TLLY4401-AS12Z	Yellow	1	2	-	2	581	-	594	2	-	2.4	2.9	2	GaAsP on GaP
TLLY4401-MS12	Yellow	1	2	-	2	581	-	594	2	-	2.4	2.9	2	GaAsP on GaP
TLLG4400	Green	0.63	1.2	-	2	562	-	575	2	-	1.9	2.4	2	GaP on GaP
TLLG4400-AS12	Green	0.63	1.2	-	2	562	-	575	2	-	1.9	2.4	2	GaP on GaP
TLLG4401	Green	1	2	-	2	562	-	575	2	-	1.9	2.4	2	GaP on GaP
TLLG4401-AS12	Green	1	2	-	2	562	-	575	2	-	1.9	2.4	2	GaP on GaP
TLLG4401-MS12	Green	1	2	-	2	562	-	575	2	-	1.9	2.4	2	GaP on GaP
TLLG4401-MS21	Green	1	2	-	2	562	-	575	2	-	1.9	2.4	2	GaP on GaP

**ABSOLUTE MAXIMUM RATINGS** ( $T_{amb} = 25\text{ }^{\circ}\text{C}$ , unless otherwise specified)  
**TLLG440., TLLR440., TLLY440.**

PARAMETER	TEST CONDITION	SYMBOL	VALUE	UNIT
Reverse voltage		$V_R$	6	V
DC forward current		$I_F$	7	mA
Surge forward current	$t_p \leq 10\ \mu\text{s}$	$I_{FSM}$	0.15	A
Power dissipation	$T_{amb} \leq 84\text{ }^{\circ}\text{C}$	$P_V$	20	mW
Junction temperature		$T_j$	100	$^{\circ}\text{C}$
Operating temperature range		$T_{amb}$	-40 to +100	$^{\circ}\text{C}$
Storage temperature range		$T_{stg}$	-55 to +100	$^{\circ}\text{C}$
Soldering temperature	$t \leq 5\ \text{s}$ , 2 mm from body	$T_{sd}$	260	$^{\circ}\text{C}$
Thermal resistance junction-to-ambient		$R_{thJA}$	800	K/W

**OPTICAL AND ELECTRICAL CHARACTERISTICS** ( $T_{amb} = 25\text{ }^{\circ}\text{C}$ , unless otherwise specified)  
**TLLR440., RED**

PARAMETER	TEST CONDITION	PART	SYMBOL	MIN.	TYP.	MAX.	UNIT
Luminous intensity <sup>(1)</sup>	$I_F = 2\ \text{mA}$	TLLR4400	$I_V$	0.63	1.2	-	mcd
		TLLR4401	$I_V$	1	2	-	mcd
Dominant wavelength	$I_F = 2\ \text{mA}$		$\lambda_d$	612	-	625	nm
Peak wavelength	$I_F = 2\ \text{mA}$		$\lambda_p$	-	635	-	nm
Angle of half intensity	$I_F = 2\ \text{mA}$		$\phi$	-	$\pm 25$	-	deg
Forward voltage	$I_F = 2\ \text{mA}$		$V_F$	-	1.9	2.4	V
Reverse voltage	$I_R = 10\ \mu\text{A}$		$V_R$	6	20	-	V
Junction capacitance	$V_R = 0\ \text{V}$ , $f = 1\ \text{MHz}$		$C_j$	-	50	-	pF

**Note**<sup>(1)</sup> In one packing unit  $I_{Vmin.}/I_{Vmax.} \leq 0.5$ **OPTICAL AND ELECTRICAL CHARACTERISTICS** ( $T_{amb} = 25\text{ }^{\circ}\text{C}$ , unless otherwise specified)  
**TLLY440., YELLOW**

PARAMETER	TEST CONDITION	PART	SYMBOL	MIN.	TYP.	MAX.	UNIT
Luminous intensity <sup>(1)</sup>	$I_F = 2\ \text{mA}$	TLLY4400	$I_V$	0.63	1.2	-	mcd
		TLLY4401	$I_V$	1	2	-	mcd
Dominant wavelength	$I_F = 2\ \text{mA}$		$\lambda_d$	581	-	594	nm
Peak wavelength	$I_F = 2\ \text{mA}$		$\lambda_p$	-	585	-	nm
Angle of half intensity	$I_F = 2\ \text{mA}$		$\phi$	-	$\pm 25$	-	deg
Forward voltage	$I_F = 2\ \text{mA}$		$V_F$	-	2.4	2.9	V
Reverse voltage	$I_R = 10\ \mu\text{A}$		$V_R$	6	20	-	V
Junction capacitance	$V_R = 0\ \text{V}$ , $f = 1\ \text{MHz}$		$C_j$	-	50	-	pF

**Note**<sup>(1)</sup> In one packing unit  $I_{Vmin.}/I_{Vmax.} \leq 0.5$





OPTICAL AND ELECTRICAL CHARACTERISTICS (T <sub>amb</sub> = 25 °C, unless otherwise specified)							
TLLG440., GREEN							
PARAMETER	TEST CONDITION	PART	SYMBOL	MIN.	TYP.	MAX.	UNIT
Luminous intensity <sup>(1)</sup>	I <sub>F</sub> = 2 mA	TLLG4400	I <sub>V</sub>	0.63	1.2	-	mcd
		TLLG4401	I <sub>V</sub>	1	2	-	mcd
Dominant wavelength	I <sub>F</sub> = 2 mA		λ <sub>d</sub>	562	-	575	nm
Peak wavelength	I <sub>F</sub> = 2 mA		λ <sub>p</sub>	-	565	-	nm
Angle of half intensity	I <sub>F</sub> = 2 mA		φ	-	± 25	-	deg
Forward voltage	I <sub>F</sub> = 2 mA		V <sub>F</sub>	-	1.9	2.4	V
Reverse voltage	I <sub>R</sub> = 10 μA		V <sub>R</sub>	6	20	-	V
Junction capacitance	V <sub>R</sub> = 0 V, f = 1 MHz		C <sub>j</sub>	-	50	-	pF

Note

<sup>(1)</sup> In one packing unit I<sub>Vmin</sub>/I<sub>Vmax</sub> ≤ 0.5

LUMINOUS INTENSITY CLASSIFICATION		
GROUP	LIGHT INTENSITY (mcd)	
STANDARD	MIN.	MAX.
K	0.63	1.25
L	1	2
M	1.6	3.2
N	2.5	5
P	4	8
Q	6.3	12.5
R	10	20
S	16	32
T	25	50
U	40	80

Note

- Luminous intensity is tested at a current pulse duration of 25 ms. The above type numbers represent the order groups which include only a few brightness groups. Only one group will be shipped on each bag (there will be no mixing of two groups on each bag). In order to ensure availability, single brightness groups will not be orderable. In a similar manner for colors where wavelength groups are measured and binned, single wavelength groups will be shipped on any one bag. In order to ensure availability, single wavelength groups will not be orderable

COLOR CLASSIFICATION				
GROUP	DOM. WAVELENGTH (nm)			
	YELLOW		GREEN	
	MIN.	MAX.	MIN.	MAX.
0	-	-	-	-
1	581	584	-	-
2	583	586	-	-
3	585	588	562	565
4	587	590	564	567
5	589	592	566	569
6	591	594	568	571
7	-	-	570	573
8	-	-	572	575

Note

- Wavelengths are tested at a current pulse duration of 25 ms



TYPICAL CHARACTERISTICS (T<sub>amb</sub> = 25 °C, unless otherwise specified)

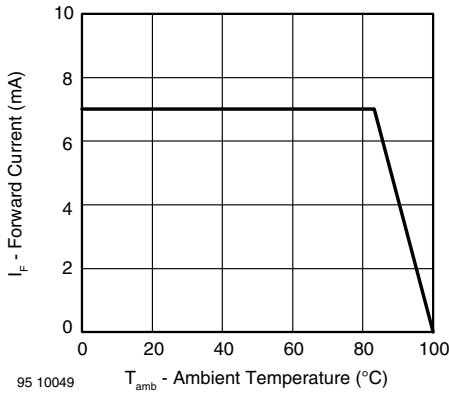

Fig. 1 - Forward Current vs. Ambient Temperature

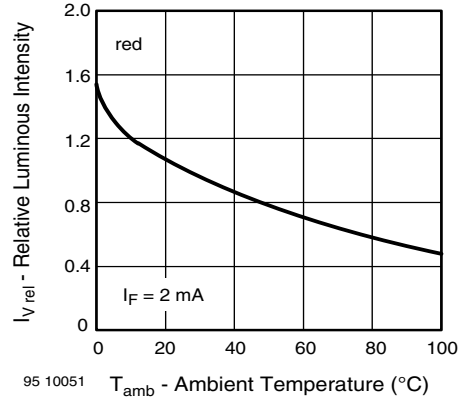

Fig. 4 - Relative Luminous Intensity vs. Ambient Temperature

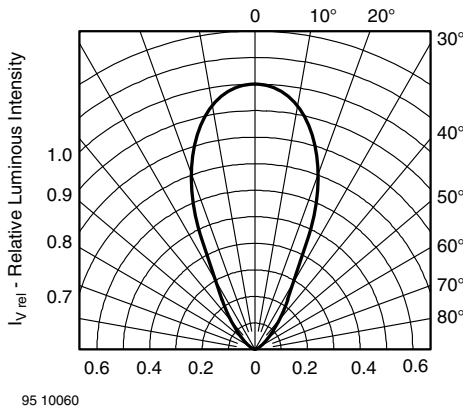

Fig. 2 - Relative Luminous Intensity vs. Angular Displacement

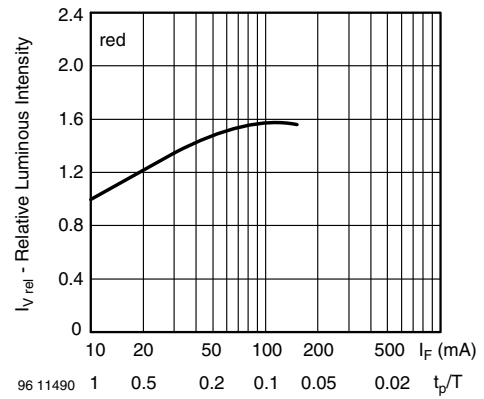

Fig. 5 - Relative Luminous Intensity vs. Forward Current/Duty Cycle

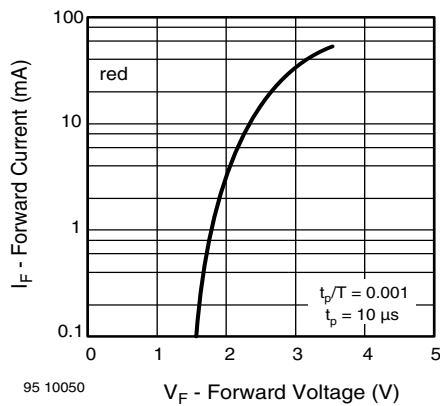

Fig. 3 - Forward Current vs. Forward Voltage

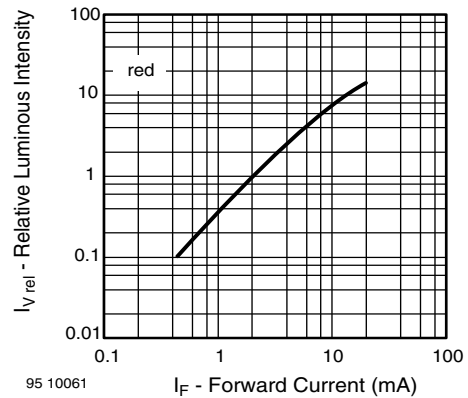

Fig. 6 - Relative Luminous Intensity vs. Forward Current

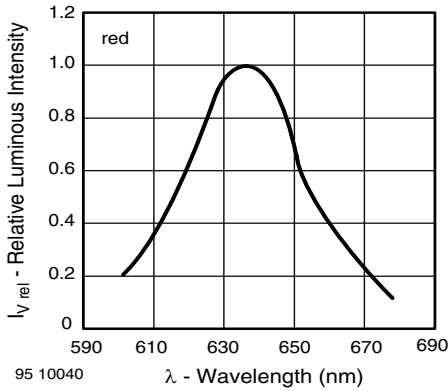

Fig. 7 - Relative Intensity vs. Wavelength

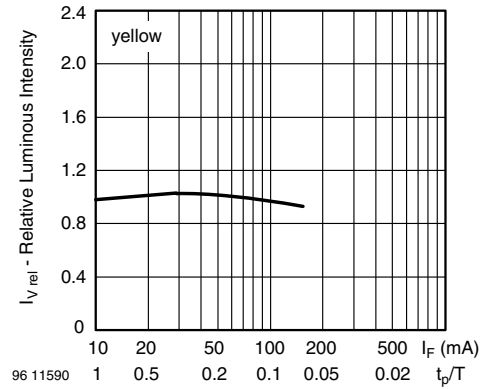

Fig. 10 - Relative Luminous Intensity vs. Forward Current/Duty Cycle

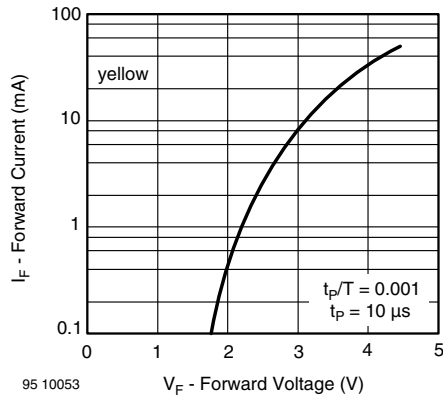

Fig. 8 - Forward Current vs. Forward Voltage

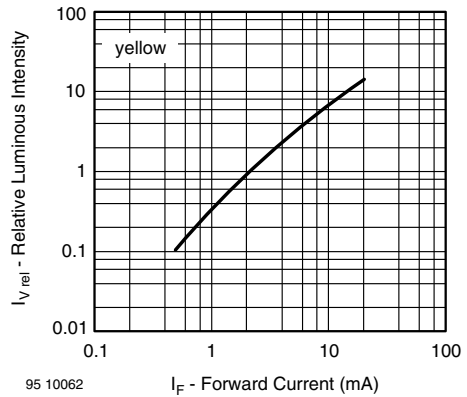

Fig. 11 - Relative Luminous Intensity vs. Forward Current

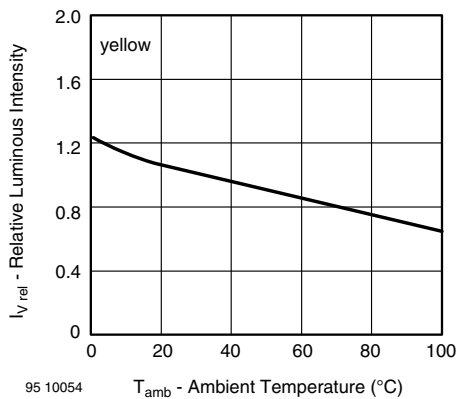

Fig. 9 - Relative Luminous Intensity vs. Ambient Temperature

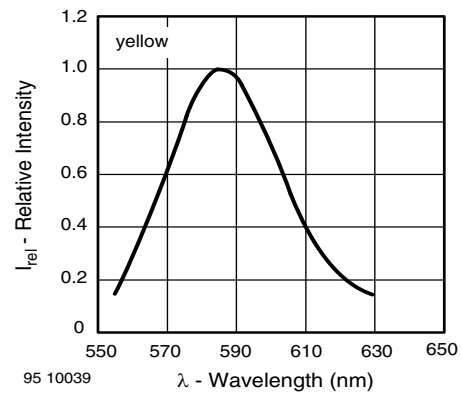

Fig. 12 - Relative Intensity vs. Wavelength

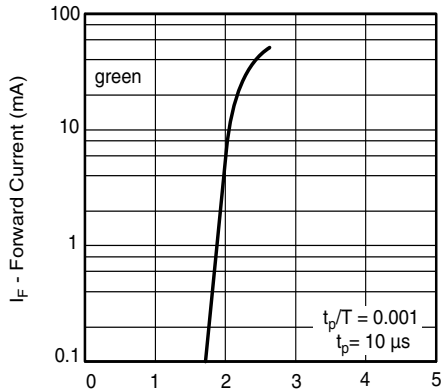

Fig. 13 - Forward Current vs. Forward Voltage

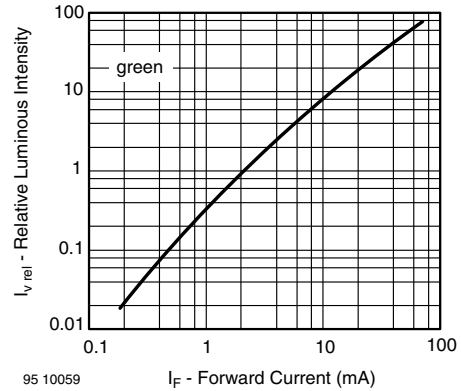

Fig. 16 - Relative Luminous Intensity vs. Forward Current

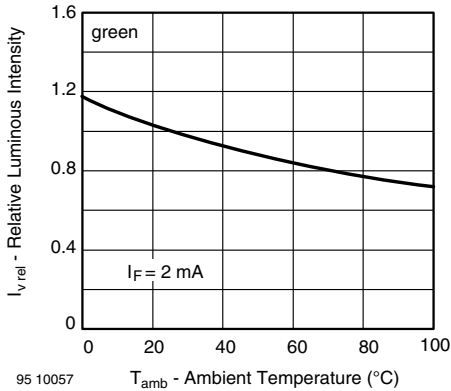

Fig. 14 - Relative Luminous Intensity vs. Ambient Temperature

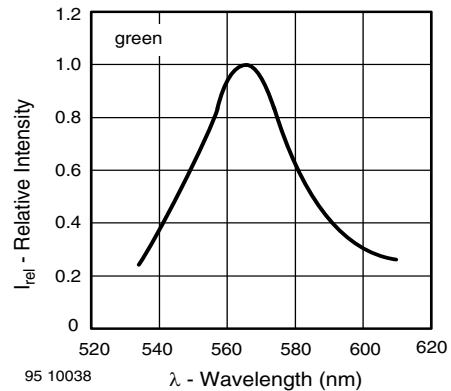

Fig. 17 - Relative Intensity vs. Wavelength

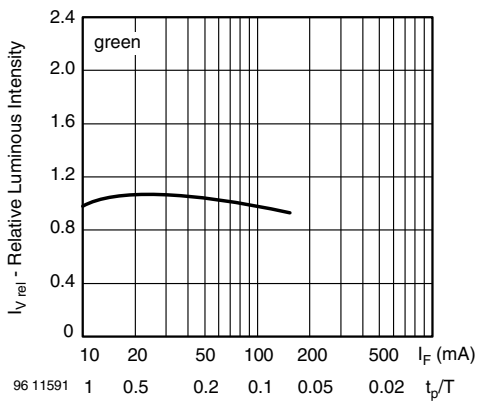
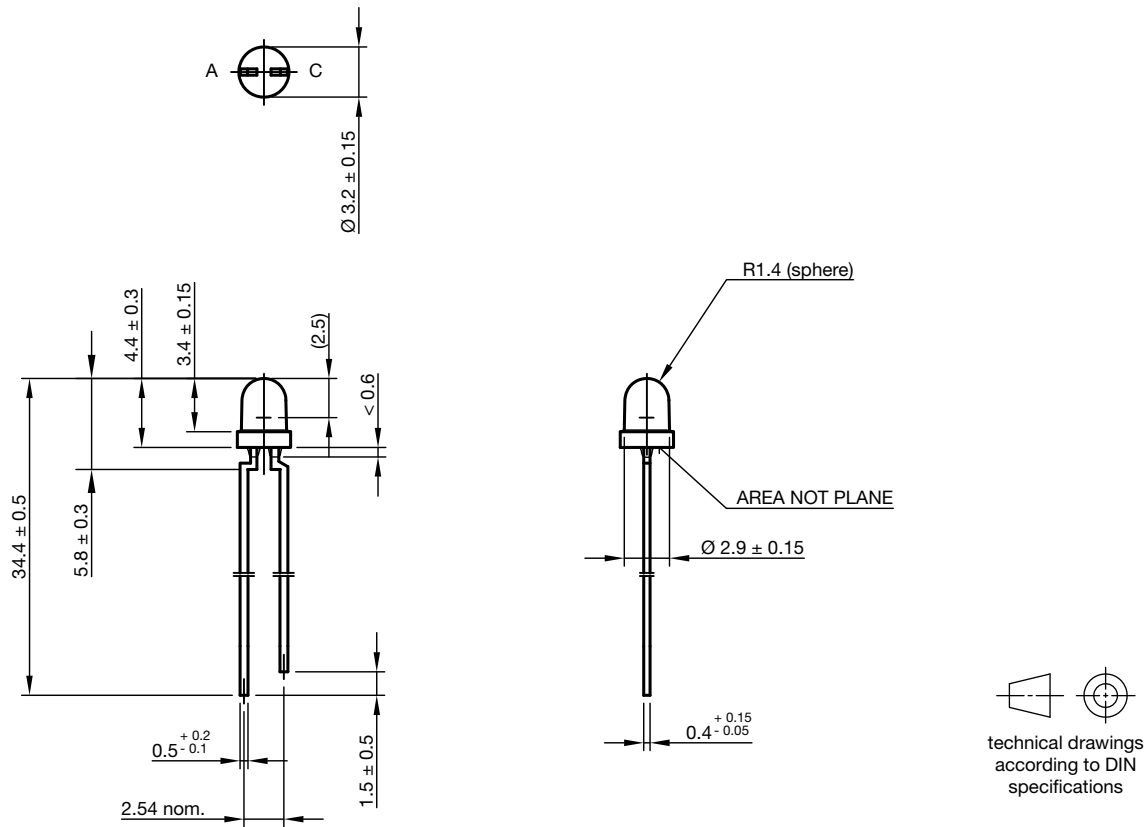

Fig. 15 - Relative Luminous Intensity vs. Forward Current/Duty Cycle



PACKAGE DIMENSIONS in millimeters



Drawing-No.: 6.544-5255.01-4  
Issue: 9; 28.07.14

REEL DIMENSIONS in millimeters

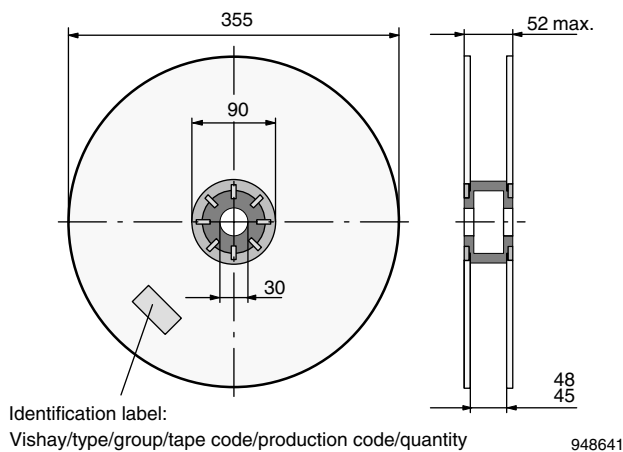

Fig. 18 - Reel

AS12 = cathode leaves tape first  
AS21 = anode leaves tape first

TAPE

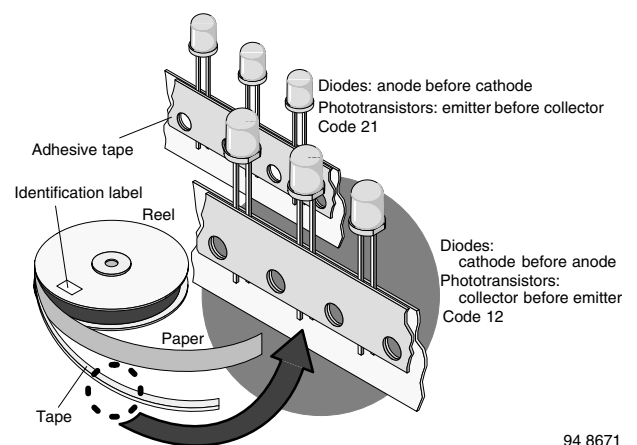

Fig. 19 - LED in Tape



## AMMOPACK

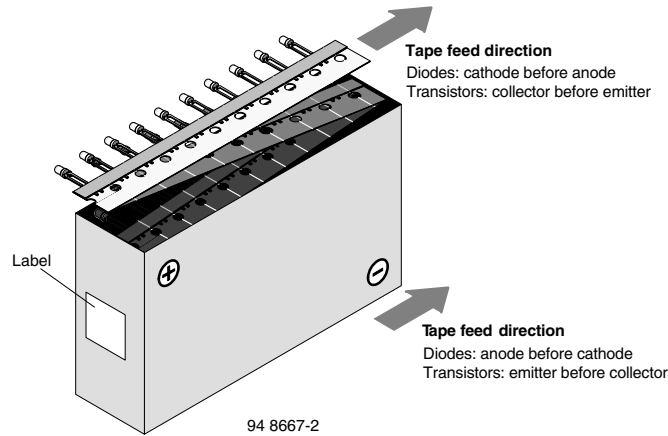
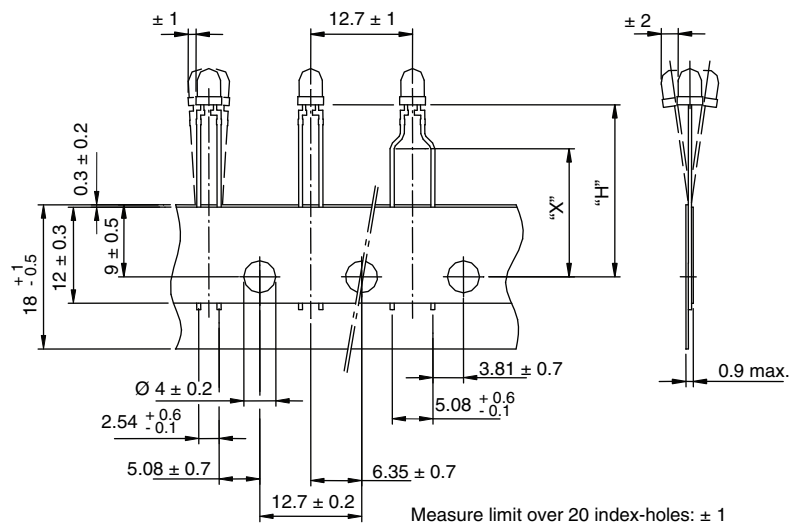

Fig. 20 - Tape Direction

### Note

- The new nomenclature for ammpack is e.g. ASZ only, without suffix for the LED orientation. The carton box has to be turned to the desired position: "+" for anode first, or "-" for cathode first. AS12Z and AS21Z are still valid for already existing types, BUT NOT FOR NEW DESIGN

### TAPE DIMENSIONS in millimeters



Quantity per:	Reel (Mat.-no. 1764)
	2000

21885

OPTION	DIMENSION "H" ± 0.5 mm
AS	17.3
MS	25.5



## Disclaimer

ALL PRODUCT, PRODUCT SPECIFICATIONS AND DATA ARE SUBJECT TO CHANGE WITHOUT NOTICE TO IMPROVE RELIABILITY, FUNCTION OR DESIGN OR OTHERWISE.

Vishay Intertechnology, Inc., its affiliates, agents, and employees, and all persons acting on its or their behalf (collectively, "Vishay"), disclaim any and all liability for any errors, inaccuracies or incompleteness contained in any datasheet or in any other disclosure relating to any product.

Vishay makes no warranty, representation or guarantee regarding the suitability of the products for any particular purpose or the continuing production of any product. To the maximum extent permitted by applicable law, Vishay disclaims (i) any and all liability arising out of the application or use of any product, (ii) any and all liability, including without limitation special, consequential or incidental damages, and (iii) any and all implied warranties, including warranties of fitness for particular purpose, non-infringement and merchantability.

Statements regarding the suitability of products for certain types of applications are based on Vishay's knowledge of typical requirements that are often placed on Vishay products in generic applications. Such statements are not binding statements about the suitability of products for a particular application. It is the customer's responsibility to validate that a particular product with the properties described in the product specification is suitable for use in a particular application. Parameters provided in datasheets and / or specifications may vary in different applications and performance may vary over time. All operating parameters, including typical parameters, must be validated for each customer application by the customer's technical experts. Product specifications do not expand or otherwise modify Vishay's terms and conditions of purchase, including but not limited to the warranty expressed therein.

Except as expressly indicated in writing, Vishay products are not designed for use in medical, life-saving, or life-sustaining applications or for any other application in which the failure of the Vishay product could result in personal injury or death. Customers using or selling Vishay products not expressly indicated for use in such applications do so at their own risk. Please contact authorized Vishay personnel to obtain written terms and conditions regarding products designed for such applications.

No license, express or implied, by estoppel or otherwise, to any intellectual property rights is granted by this document or by any conduct of Vishay. Product names and markings noted herein may be trademarks of their respective owners.