



Chipsmall Limited consists of a professional team with an average of over 10 year of expertise in the distribution of electronic components. Based in Hongkong, we have already established firm and mutual-benefit business relationships with customers from,Europe,America and south Asia,supplying obsolete and hard-to-find components to meet their specific needs.

With the principle of "Quality Parts,Customers Priority,Honest Operation,and Considerate Service",our business mainly focus on the distribution of electronic components. Line cards we deal with include Microchip,ALPS,ROHM,Xilinx,Pulse,ON,Everlight and Freescale. Main products comprise IC,Modules,Potentiometer,IC Socket,Relay,Connector.Our parts cover such applications as commercial,industrial, and automotives areas.

We are looking forward to setting up business relationship with you and hope to provide you with the best service and solution. Let us make a better world for our industry!



## Contact us

Tel: +86-755-8981 8866 Fax: +86-755-8427 6832

Email & Skype: info@chipsmall.com Web: www.chipsmall.com

Address: A1208, Overseas Decoration Building, #122 Zhenhua RD., Futian, Shenzhen, China



# TLP292-4

**Programmable Controllers  
Switching Power Supplies  
Simplex/Multiplex Data Transmissions**

TLP292-4 consists of phototransistors optically coupled to two InGaAs infrared emitting diodes connected inverse parallel, and can operate directly by AC input current.

TLP292-4 is housed in the very small and thin SO16 package.

Since TLP292-4 is guaranteed wide operating temperature (Ta=-55 to 125 °C) and high isolation voltage (3750 Vrms), it is suitable for high-density surface mount applications such as programmable controllers.

- Collector-Emitter Voltage : 80 V (min)
- Current Transfer Ratio : 50% (min)  
Rank GB: 100 %(min)
- Isolation Voltage : 3750 Vrms (min)
- Operation temperature range: -55 to 125 °C
- Safety standards  
UL- approved: UL1577, File No. E67349  
cUL- approved: CSA Component Acceptance Service No.5A,  
File No. E67349

CQC- approved : GB4943.1, GB8898



仅适用于海拔 2000 m 以下地区安全使用

VDE-under application : EN60747-5-5 (Note)

Note : When an EN60747-5-5 approved type is needed,  
please designate the Option (V4).

**Construction Mechanical Rating**

Creepage Distance	5.0 mm (min)
Clearance	5.0 mm (min)
Internal isolation thickness	0.4 mm (min)

Unit: mm

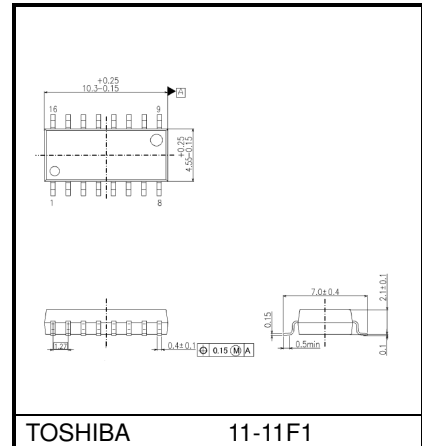

TOSHIBA 11-11F1

Weight: 0.19 g (typ.)

**Pin Configuration**

TLP292-4

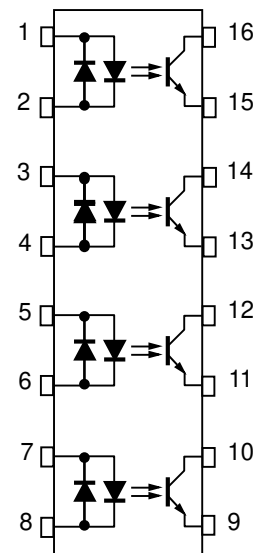

- 1,3,5,7 : Cathode, Anode
- 2,4,6,8 : Anode, Cathode
- 9,11,13,15 : Emitter
- 10,12,14,16 : Collector

Start of commercial production  
2014-04

## Current Transfer Ratio (Unless otherwise specified, Ta=25°C)

Rank (Note1)	Test condition	Current Transfer Ratio (%)		Marking of Classification
		I <sub>C</sub> / I <sub>F</sub>		
		Min	Max	
Blank	I <sub>F</sub> = ±5 mA, V <sub>CE</sub> = 5 V	50	600	Blank
GB		100	600	GB
LA (Note2)	I <sub>F</sub> = ±0.5 mA, V <sub>CE</sub> = 5 V	50	600	LA
LGB (Note2)		100	600	LB

Note 1: Specify both the part number and a rank in this format when ordering.

Example: rank GB: TLP292-4(GB,E)

For safety standard certification, however, specify the part number alone.

TLP292-4 (GB,E: TLP292-4

Note2: The LA and LGB rank are made CTR rank of the low input current condition.

## Absolute Maximum Ratings (Note)(Unless otherwise specified, Ta = 25°C)

Characteristics		Symbol	Note	Rating	Unit
LED	R.M.S. forward current	I <sub>F(RMS)</sub>		±50	mA
	Input forward current derating (Ta≥50°C)	ΔI <sub>F</sub> / ΔTa		-0.59	mA /°C
	Input forward current(Pulsed)	I <sub>FP</sub>	(Note1)	±1	A
	LED power dissipation	P <sub>D</sub>		70	mW
	LED power dissipation derating(Ta≥50°C)	ΔP <sub>D</sub> / ΔTa		-0.82	mW /°C
	Junction temperature	T <sub>j</sub>		125	°C
DETECTOR	Collector-emitter voltage	V <sub>CEO</sub>		80	V
	Emitter-collector voltage	V <sub>ECO</sub>		7	V
	Collector current	I <sub>C</sub>		50	mA
	Collector power dissipation (1 Circuit)	P <sub>C</sub>		100	mW
	Collector power dissipation derating(Ta≥25°C) (1 Circuit)	ΔP <sub>C</sub> / ΔTa		-0.91	mW /°C
	Junction temperature	T <sub>j</sub>		125	°C
COMMON	Operating temperature range	T <sub>opr</sub>		-55 to 125	°C
	Storage temperature range	T <sub>stg</sub>		-55 to 125	°C
	Lead soldering temperature	T <sub>sol</sub>		260 (10 s)	°C
	Total power dissipation (1 Circuit)	P <sub>T</sub>		170	mW
	Input power dissipation derating (Ta≥25°C) (1 Circuit)	ΔP <sub>T</sub> / ΔTa		-1.55	mW /°C
	Isolation Voltage AC, 60s, R.H.≤60%	BV <sub>S</sub>	(Note2)	3750	V <sub>rms</sub>

Note: Using continuously under heavy loads (e.g. the application of high temperature/current/voltage and the significant change in temperature, etc.) may cause this product to decrease in the reliability significantly even if the operating conditions (i.e. operating temperature/current/voltage, etc.) are within the absolute maximum ratings.

Please design the appropriate reliability upon reviewing the Toshiba Semiconductor Reliability Handbook (“Handling Precautions”/“Derating Concept and Methods”) and individual reliability data (i.e. reliability test report and estimated failure rate, etc).

Note1: Pulse width ≤ 100 μs, frequency 100 Hz

Note2: This device is considered as a two-terminal device: All pins on the LED side are shorted together, and all pin on the photodetector side are shorted together.

## Electrical Characteristics (Unless otherwise specified, Ta = 25°C)

CHARACTERISTIC		SYMBOL	TEST CONDITION	MIN	TYP.	MAX	UNIT
LED	Input forward voltage	V <sub>F</sub>	I <sub>F</sub> = ±10 mA	1.1	1.25	1.4	V
	Input capacitance	C <sub>T</sub>	V = 0 V, f = 1 MHz	—	60	—	pF
DETECTOR	Collector-emitter breakdown voltage	V <sub>(BR) CEO</sub>	I <sub>C</sub> = 0.5 mA	80	—	—	V
	Emitter-collector breakdown voltage	V <sub>(BR) ECO</sub>	I <sub>E</sub> = 0.1 mA	7	—	—	V
	Dark current	I <sub>DARK</sub>	V <sub>CE</sub> = 48 V,	—	0.01	0.08	μA
			V <sub>CE</sub> = 48 V, Ta = 85°C	—	2	50	μA
Collector-emitter capacitance	C <sub>CE</sub>	V = 0 V, f = 1 MHz	—	10	—	pF	

**Coupled Electrical Characteristics (Unless otherwise specified, Ta = 25°C)**

CHARACTERISTIC	SYMBOL	TEST CONDITION	MIN	TYP.	MAX	UNIT
Current transfer ratio	I <sub>C</sub> / I <sub>F</sub>	I <sub>F</sub> = ±5 mA, V <sub>CE</sub> = 5 V Rank GB	50	—	600	%
			100	—	600	
Saturated current transfer ratio	I <sub>C</sub> / I <sub>F</sub> (sat)	I <sub>F</sub> = ±1 mA, V <sub>CE</sub> = 0.4 V Rank GB	—	60	—	%
			30	—	—	
Collector-emitter saturation voltage	V <sub>CE</sub> (sat)	I <sub>C</sub> = 2.4 mA, I <sub>F</sub> = ±8 mA	—	—	0.3	V
		I <sub>C</sub> = 0.2 mA, I <sub>F</sub> = ±1 mA	—	0.2	—	
		Rank GB	—	—	0.3	
Off-state collector current	I <sub>C</sub> (off)	V <sub>F</sub> = ±0.7 V, V <sub>CE</sub> = 48 V	—	—	10	μA
Collector current ratio	I <sub>C</sub> (ratio)	I <sub>C</sub> (I <sub>F</sub> = -5 mA) / I <sub>C</sub> (I <sub>F</sub> = 5 mA) (Figure 1)	0.33	—	3	—

Figure 1: Collector current ratio test circuit

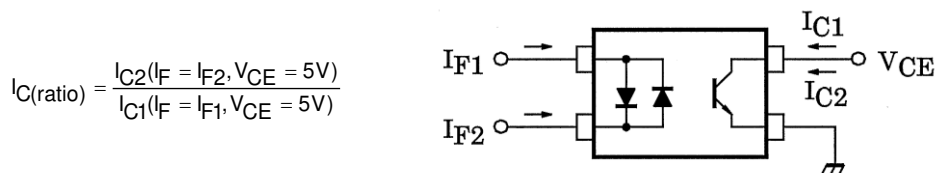

**Isolation Characteristics (Unless otherwise specified, Ta = 25°C)**

CHARACTERISTIC	SYMBOL	TEST CONDITION	MIN	TYP.	MAX	UNIT
Total capacitance (input to output)	C <sub>S</sub>	V <sub>S</sub> = 0 V, f = 1 MHz	—	0.8	—	pF
Isolation resistance	R <sub>S</sub>	V <sub>S</sub> = 500 V, R.H. ≤60%	1×10 <sup>12</sup>	10 <sup>14</sup>	—	Ω
Isolation voltage	BV <sub>S</sub>	AC, 60 s	3750	—	—	V <sub>rms</sub>
		AC, 1 s, in OIL	—	10000	—	
		DC, 60 s, in OIL	—	10000	—	V <sub>dc</sub>

**Switching Characteristics (Unless otherwise specified, Ta = 25°C)**

CHARACTERISTIC	SYMBOL	TEST CONDITION	MIN	TYP.	MAX	UNIT
Rise time	t <sub>r</sub>	V <sub>CC</sub> = 10 V, I <sub>C</sub> = 2 mA R <sub>L</sub> = 100 Ω	—	2	—	μs
Fall time	t <sub>f</sub>		—	3	—	
Turn-on time	t <sub>on</sub>		—	3	—	
Turn-off time	t <sub>off</sub>		—	3	—	
Turn-on time	t <sub>on</sub>	R <sub>L</sub> = 1.9 kΩ V <sub>CC</sub> = 5 V, I <sub>F</sub> = 16 mA (Figure 2)	—	1.5	—	μs
Storage time	t <sub>s</sub>		—	20	—	
Turn-off time	t <sub>off</sub>		—	35	—	

Figure 2: Switchin Time Test Circuit

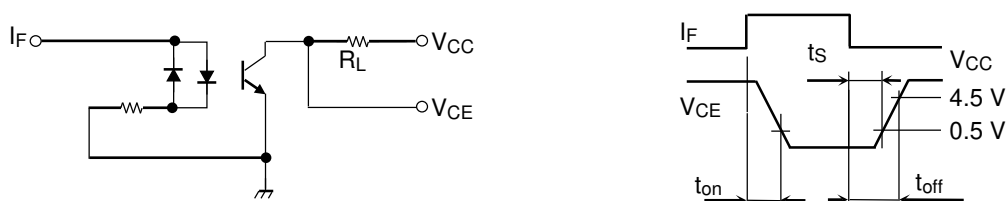

**Characteristics Curves (Note)**

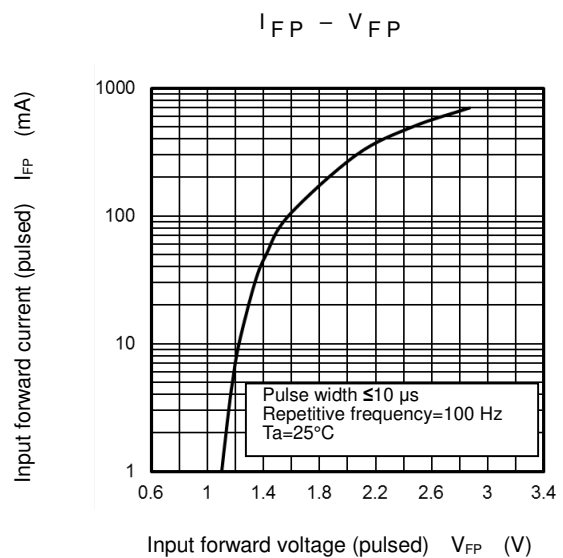
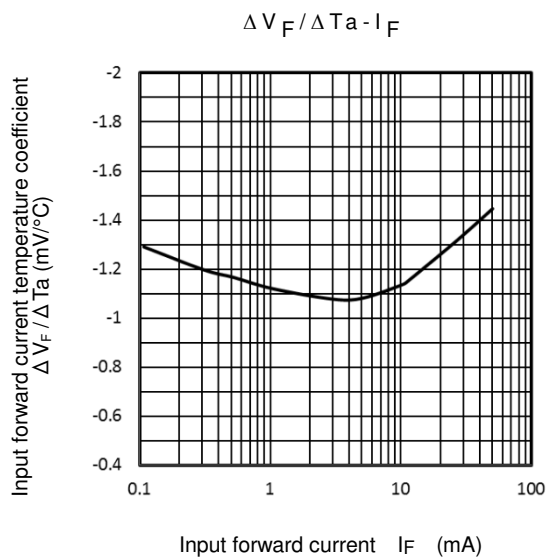
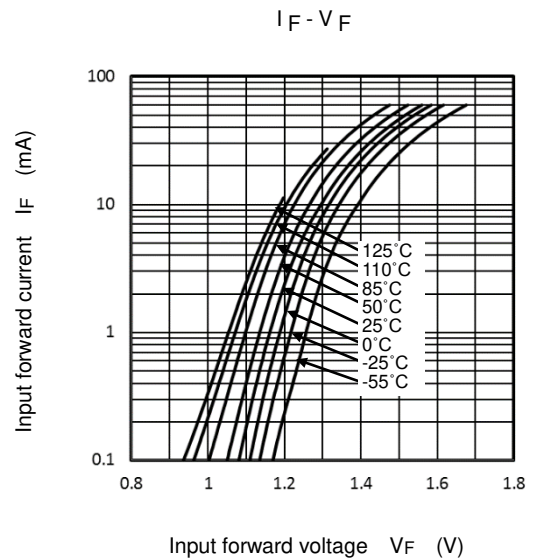
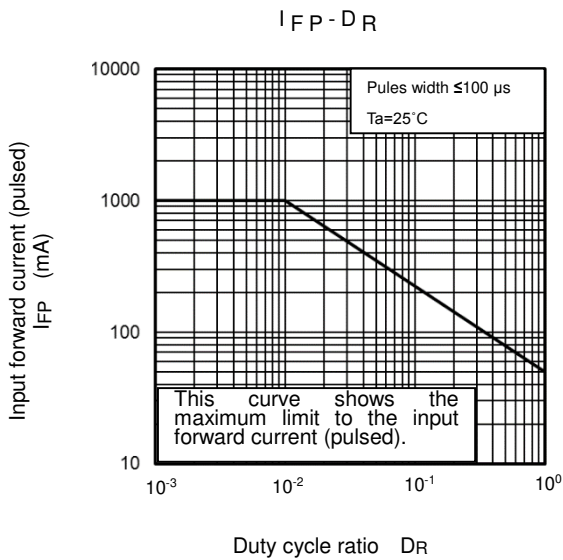
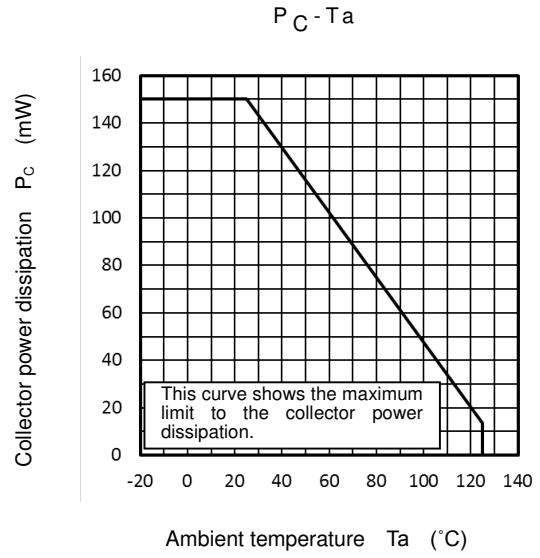
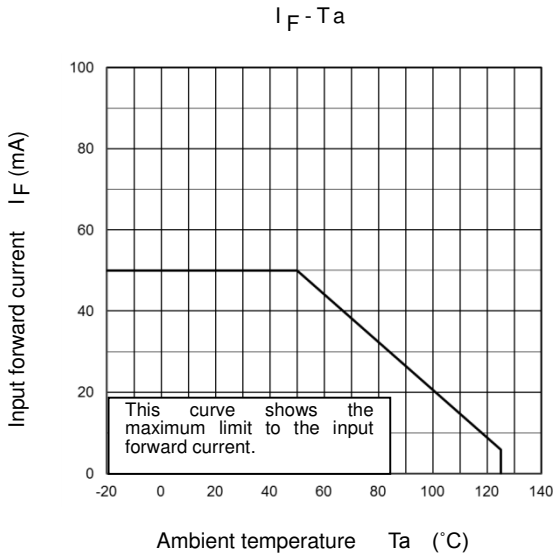

Note: The above characteristics curves are presented for reference only and not guaranteed by production test, unless otherwise noted.

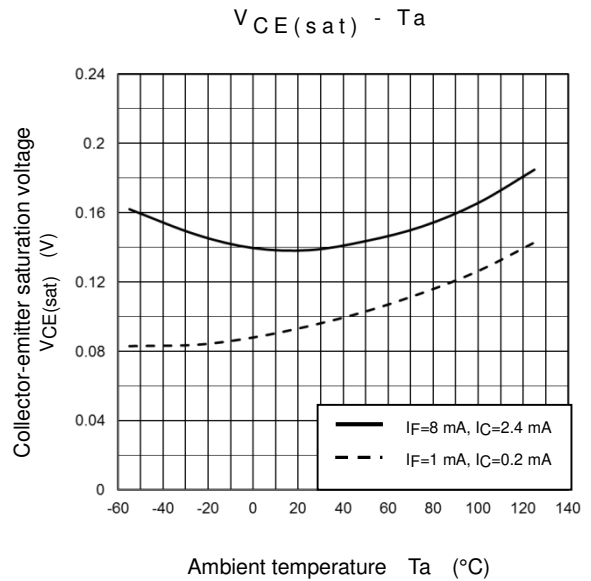
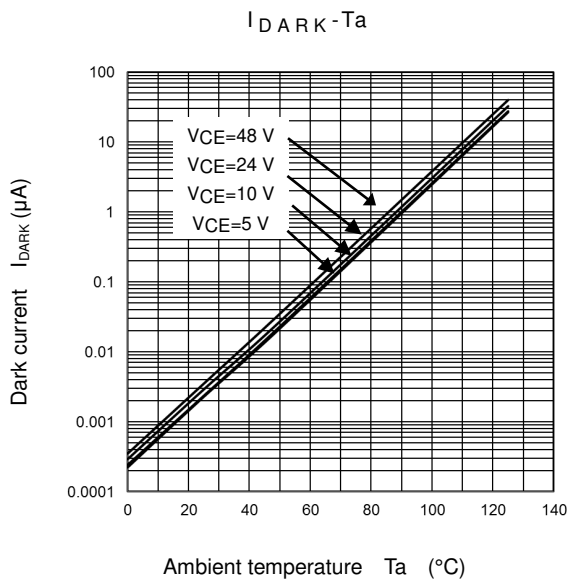
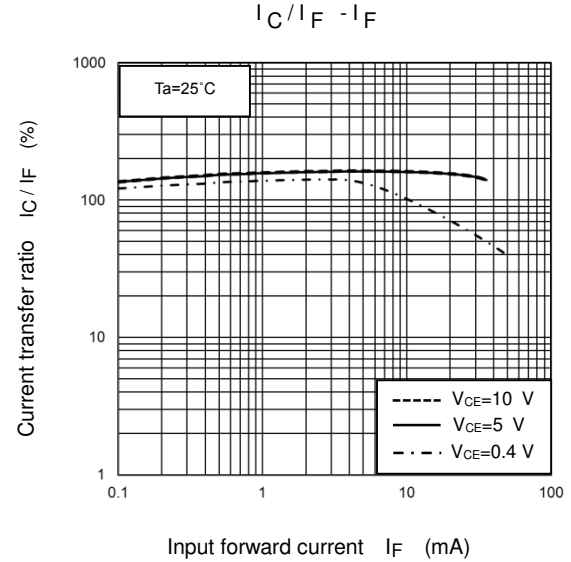
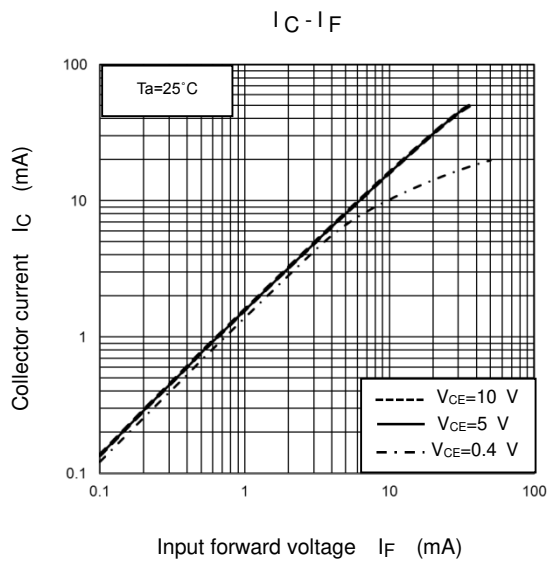
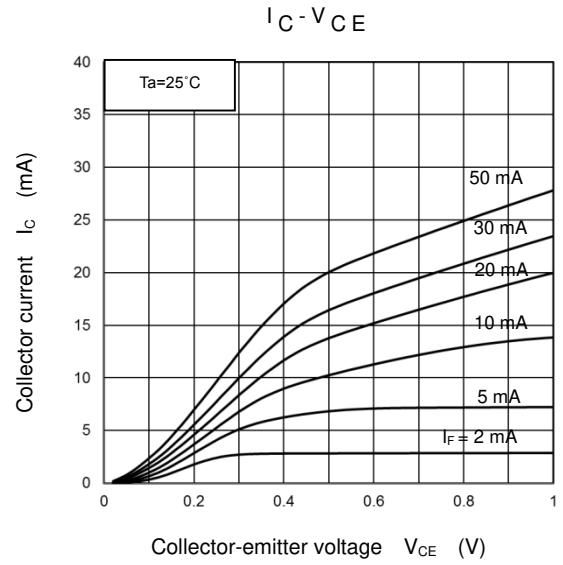
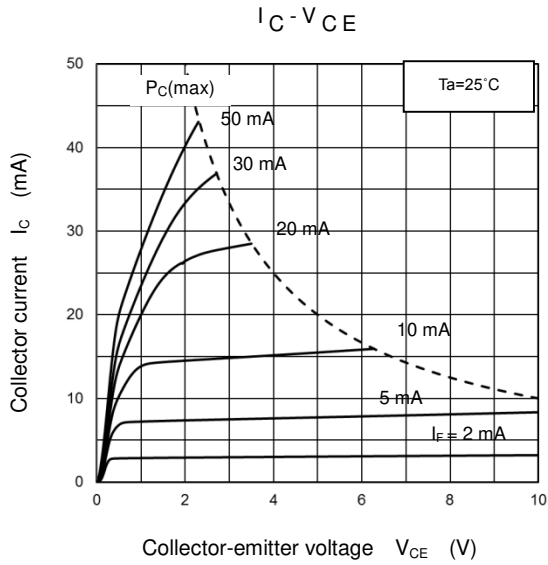

Note: The above characteristics curves are presented for reference only and not guaranteed by production test, unless otherwise noted.

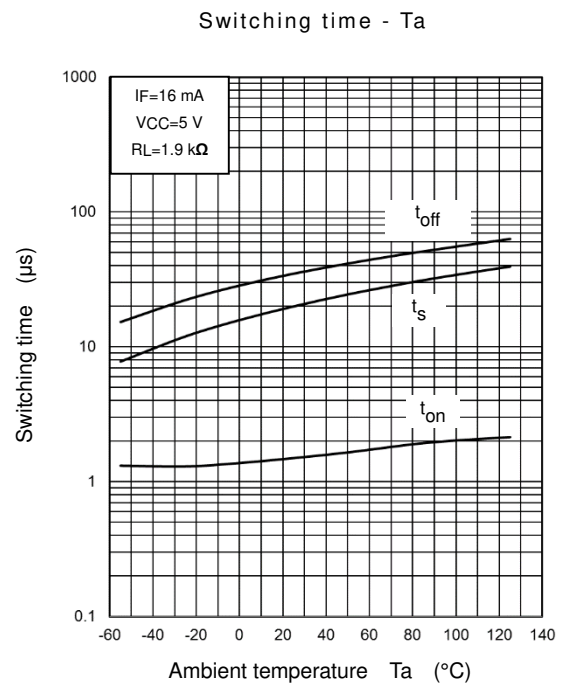
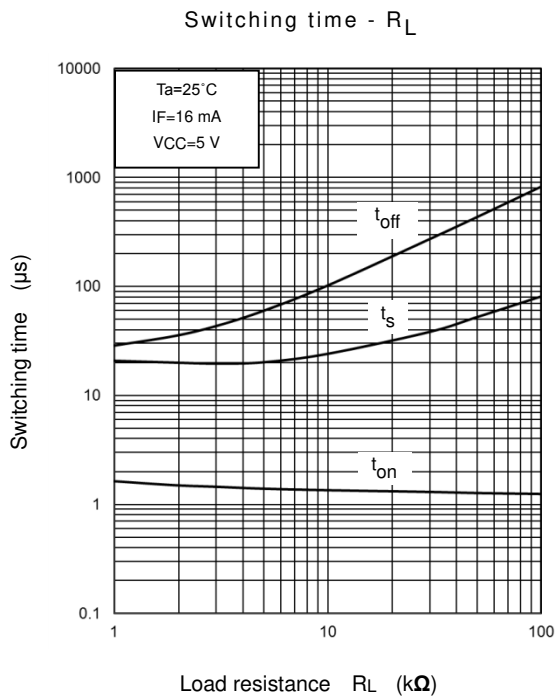
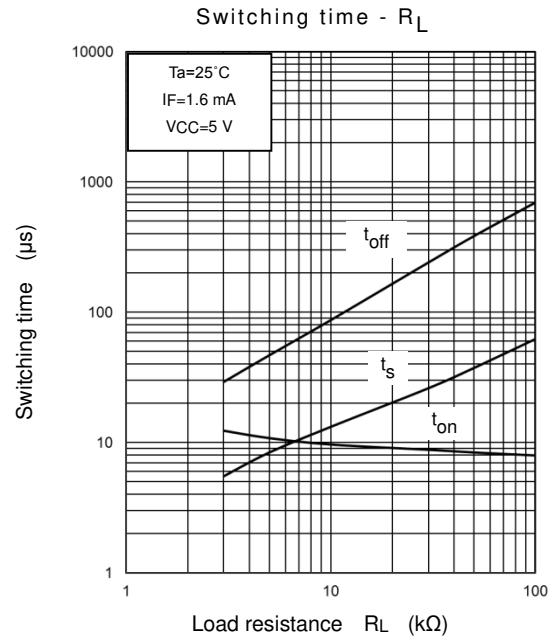
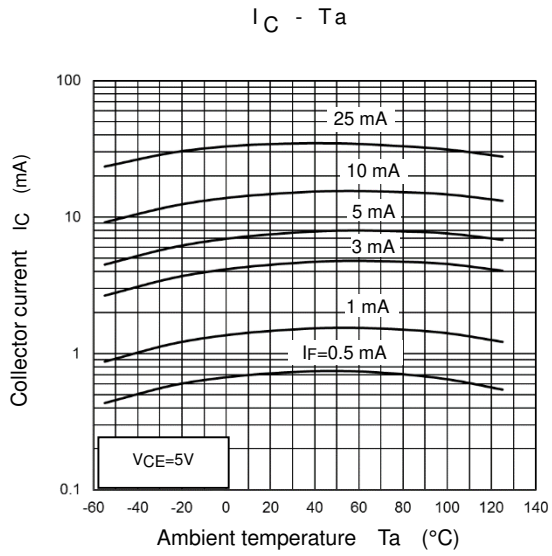

Note: The above characteristics curves are presented for reference only and not guaranteed by production test, unless otherwise noted.



## Soldering and Storage

### 1. Precautions for Soldering

The soldering temperature should be controlled as closely as possible to the conditions shown below, irrespective of whether a soldering iron or a reflow soldering method is used.

#### 1) When Using Soldering Reflow

An example of a temperature profile when lead(Pb)-free solder is used

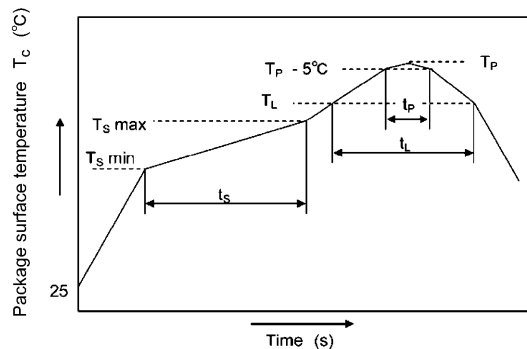

	Symbol	Min	Max	Unit
Preheat temperature	$T_s$	150	200	°C
Preheat time	$t_s$	60	120	s
Ramp-up rate ( $T_L$ to $T_P$ )			3	°C/s
Liquidus temperature	$T_L$	217		°C
Time above $T_L$	$t_L$	60	150	s
Peak temperature	$T_P$		260	°C
Time during which $T_c$ is between ( $T_P - 5$ ) and $T_P$	$t_p$		30	s
Ramp-down rate ( $T_P$ to $T_L$ )			6	°C/s

- The soldering temperature profile is based on the package surface temperature (See the figure shown below, which is based on the package surface temperature.)
- Reflow soldering must be performed once or twice.
- The mounting should be completed with the interval from the first to the last mountings being 2 weeks.

#### 2) When using soldering Flow

- Preheat the device at a temperature of 150 °C (package surface temperature) for 60 to 120 seconds.
- Mounting condition of 260 °C within 10 seconds is recommended
- Flow soldering must be performed once.

#### 3) When using soldering Iron

- Complete soldering within 10 seconds for lead temperature not exceeding 260 °C or within 3 seconds not exceeding 350 °C
- Heating by soldering iron must be done only once per lead.

### 2. Precautions for General Storage

- 1) Avoid storage locations where devices may be exposed to moisture or direct sunlight.
- 2) Follow the precautions printed on the packing label of the device for transportation and storage.
- 3) Keep the storage location temperature and humidity within a range of 5°C to 35°C and 45% to 75%, respectively.
- 4) Do not store the products in locations with poisonous gases (especially corrosive gases) or in dusty conditions.
- 5) Store the products in locations with minimal temperature fluctuations. Rapid temperature changes during storage can cause condensation, resulting in lead oxidation or corrosion, which will deteriorate the solderability of the leads.
- 6) When restoring devices after removal from their packing, use anti-static containers.
- 7) Do not allow loads to be applied directly to devices while they are in storage.
- 8) If devices have been stored for more than two years under normal storage conditions, it is recommended that you check the leads for ease of soldering prior to use.

## Option: Specification for Embossed-Tape Packing (TP) for Mini-Flat Coupler

### 1. Applicable Package

Package Name	Product Type
SO16	Mini-Flat Coupler

### 2. Product Naming System

Type of package used for shipment is denoted by a symbol suffix after a product number. The method of classification is as below.

Example) TLP292-4(GB-TP,E

Part number: TLP292-4  
 CTR rank: GB  
 Tape type: TP  
 [[G]]/RoHS COMPATIBLE: E (Note)

Note : Please contact your TOSHIBA sales representative for details as to environmental matters such as the RoHS compatibility of Product.

The RoHS is the Directive 2011/65/EU of the European Parliament and of the Council of 8 Jun 2011 on the restriction of the use of certain hazardous substances in electrical and electronics equipment.

### 3. Tape Dimensions Specification

#### 3.1 Orientation of Device in Relation to Direction of Tape Movement

Device orientation in the recesses is as shown in Figure 3.1.1.

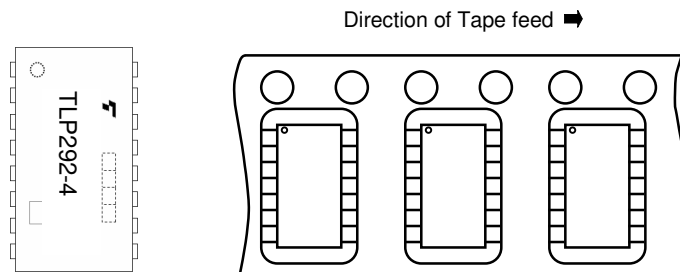

**Figure3.1.1 Device Orientation**

#### 3.2 Packing Quantity

2000 pcs per reel

#### 3.3 Empty Device Recesses are as Shown in Table 1.

**Table1 Empty Device Recesses**

	Standard	Remarks
Occurrences of 2 or more successive empty device recesses	0 device	Within any given 40-mm section of tape, not including leader and trailer
Single empty device recesses	6 device (max) per reel	Not including leader and trailer

#### 3.4 Tape Leader and Trailer

The start end of the tape has 50 or more empty cavities. The hub end of the tape has 50 or more empty cavities and two empty turns only for a cover tape.

**3.5 Tape Dimensions**

Tape material: Plastic (protection against electrostatics)

**Figure3.5.1 Tape Forms**

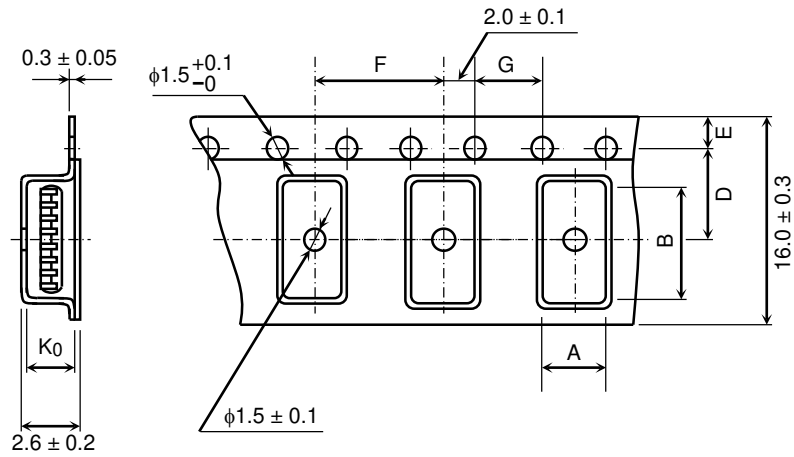

**Table 3.5.1 Tape Dimensions**

Unit: mm  
unless otherwise specified: ±0.1

Symbol	Dimension	Remark
A	7.5	—
B	10.5	—
D	7.5	Center line of indented square hole and sprocket hole
E	1.75	Distance between tape edge and hole center
F	12.0	Cumulative error +0.1/-0.3 (max) per 10 feed holes
G	4.0	Cumulative error +0.1/-0.3 (max) per 10 feed holes
K <sub>0</sub>	2.2	Internal space

**3.6 Reel specification**

Material: Plastic

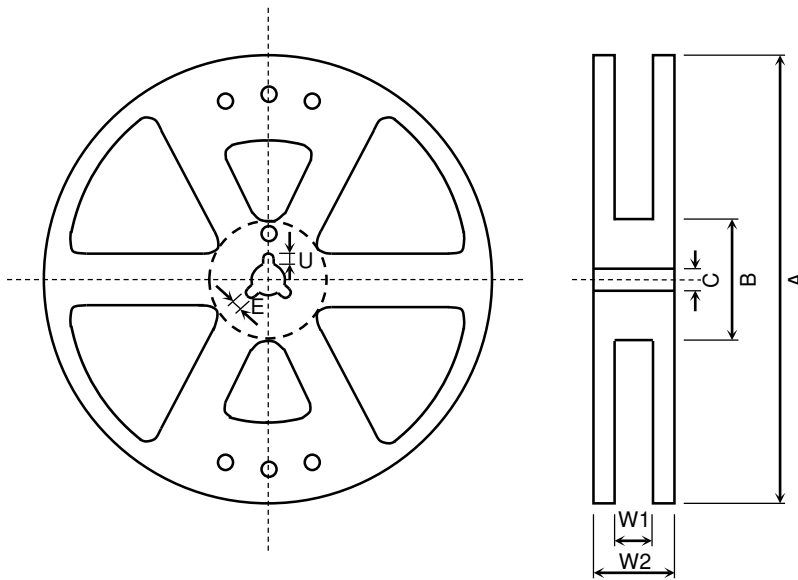

**Figure 3.6.1 Reel Dimensions**

**Table 3.6.1 Reel Dimensions**

Unit: mm

Symbol	Dimension
A	$\phi 330 \pm 2$
B	$\phi 80 \pm 1$
C	$\phi 13 \pm 0.5$
E	$2.0 \pm 0.5$
U	$4.0 \pm 0.5$
W1	$17.5 \pm 0.5$
W2	$21.5 \pm 1.0$

**4. Packing**

Either one reel or ten reels (maximum) of photocouplers are packed in a shipping carton.

**5. Label Format**

The label on each carton provides the part number, quantity, lot number, the Toshiba logo, CTR rank, etc.

**6. Ordering Information**

When placing an order, please specify the part number, CTR rank, tape type and quantity (must be a multiple of 2000) as shown in the following example.

Example) TLP292-4(GB-TP,E 2000 Pcs

- Part number: TLP292-4
- CTR rank (GB
- Tape type: TP
- [[G]]/RoHS COMPATIBLE: E (Note)
- Quantity (must be a multiple of 2000): 2000 Pcs

Note : Please contact your TOSHIBA sales representative for details as to environmental matters such as the RoHS compatibility of Product.

The RoHS is the Directive 2011/65/EU of the European Parliament and of the Council of 8 Jun 2011 on the restriction of the use of certain hazardous substances in electrical and electronics equipment.

## RESTRICTIONS ON PRODUCT USE

- Toshiba Corporation, and its subsidiaries and affiliates (collectively "TOSHIBA"), reserve the right to make changes to the information in this document, and related hardware, software and systems (collectively "Product") without notice.
- This document and any information herein may not be reproduced without prior written permission from TOSHIBA. Even with TOSHIBA's written permission, reproduction is permissible only if reproduction is without alteration/omission.
- Though TOSHIBA works continually to improve Product's quality and reliability, Product can malfunction or fail. Customers are responsible for complying with safety standards and for providing adequate designs and safeguards for their hardware, software and systems which minimize risk and avoid situations in which a malfunction or failure of Product could cause loss of human life, bodily injury or damage to property, including data loss or corruption. Before customers use the Product, create designs including the Product, or incorporate the Product into their own applications, customers must also refer to and comply with (a) the latest versions of all relevant TOSHIBA information, including without limitation, this document, the specifications, the data sheets and application notes for Product and the precautions and conditions set forth in the "TOSHIBA Semiconductor Reliability Handbook" and (b) the instructions for the application with which the Product will be used with or for. Customers are solely responsible for all aspects of their own product design or applications, including but not limited to (a) determining the appropriateness of the use of this Product in such design or applications; (b) evaluating and determining the applicability of any information contained in this document, or in charts, diagrams, programs, algorithms, sample application circuits, or any other referenced documents; and (c) validating all operating parameters for such designs and applications. **TOSHIBA ASSUMES NO LIABILITY FOR CUSTOMERS' PRODUCT DESIGN OR APPLICATIONS.**
- **PRODUCT IS NEITHER INTENDED NOR WARRANTED FOR USE IN EQUIPMENTS OR SYSTEMS THAT REQUIRE EXTRAORDINARILY HIGH LEVELS OF QUALITY AND/OR RELIABILITY, AND/OR A MALFUNCTION OR FAILURE OF WHICH MAY CAUSE LOSS OF HUMAN LIFE, BODILY INJURY, SERIOUS PROPERTY DAMAGE AND/OR SERIOUS PUBLIC IMPACT ("UNINTENDED USE").** Except for specific applications as expressly stated in this document, Unintended Use includes, without limitation, equipment used in nuclear facilities, equipment used in the aerospace industry, medical equipment, equipment used for automobiles, trains, ships and other transportation, traffic signaling equipment, equipment used to control combustions or explosions, safety devices, elevators and escalators, devices related to electric power, and equipment used in finance-related fields. **IF YOU USE PRODUCT FOR UNINTENDED USE, TOSHIBA ASSUMES NO LIABILITY FOR PRODUCT.** For details, please contact your TOSHIBA sales representative.
- Do not disassemble, analyze, reverse-engineer, alter, modify, translate or copy Product, whether in whole or in part.
- Product shall not be used for or incorporated into any products or systems whose manufacture, use, or sale is prohibited under any applicable laws or regulations.
- The information contained herein is presented only as guidance for Product use. No responsibility is assumed by TOSHIBA for any infringement of patents or any other intellectual property rights of third parties that may result from the use of Product. No license to any intellectual property right is granted by this document, whether express or implied, by estoppel or otherwise.
- **ABSENT A WRITTEN SIGNED AGREEMENT, EXCEPT AS PROVIDED IN THE RELEVANT TERMS AND CONDITIONS OF SALE FOR PRODUCT, AND TO THE MAXIMUM EXTENT ALLOWABLE BY LAW, TOSHIBA (1) ASSUMES NO LIABILITY WHATSOEVER, INCLUDING WITHOUT LIMITATION, INDIRECT, CONSEQUENTIAL, SPECIAL, OR INCIDENTAL DAMAGES OR LOSS, INCLUDING WITHOUT LIMITATION, LOSS OF PROFITS, LOSS OF OPPORTUNITIES, BUSINESS INTERRUPTION AND LOSS OF DATA, AND (2) DISCLAIMS ANY AND ALL EXPRESS OR IMPLIED WARRANTIES AND CONDITIONS RELATED TO SALE, USE OF PRODUCT, OR INFORMATION, INCLUDING WARRANTIES OR CONDITIONS OF MERCHANTABILITY, FITNESS FOR A PARTICULAR PURPOSE, ACCURACY OF INFORMATION, OR NONINFRINGEMENT.**
- GaAs (Gallium Arsenide) is used in Product. GaAs is harmful to humans if consumed or absorbed, whether in the form of dust or vapor. Handle with care and do not break, cut, crush, grind, dissolve chemically or otherwise expose GaAs in Product.
- Do not use or otherwise make available Product or related software or technology for any military purposes, including without limitation, for the design, development, use, stockpiling or manufacturing of nuclear, chemical, or biological weapons or missile technology products (mass destruction weapons). Product and related software and technology may be controlled under the applicable export laws and regulations including, without limitation, the Japanese Foreign Exchange and Foreign Trade Law and the U.S. Export Administration Regulations. Export and re-export of Product or related software or technology are strictly prohibited except in compliance with all applicable export laws and regulations.
- Please contact your TOSHIBA sales representative for details as to environmental matters such as the RoHS compatibility of Product. Please use Product in compliance with all applicable laws and regulations that regulate the inclusion or use of controlled substances, including without limitation, the EU RoHS Directive. **TOSHIBA ASSUMES NO LIABILITY FOR DAMAGES OR LOSSES OCCURRING AS A RESULT OF NONCOMPLIANCE WITH APPLICABLE LAWS AND REGULATIONS.**