



Chipsmall Limited consists of a professional team with an average of over 10 year of expertise in the distribution of electronic components. Based in Hongkong, we have already established firm and mutual-benefit business relationships with customers from,Europe,America and south Asia,supplying obsolete and hard-to-find components to meet their specific needs.

With the principle of "Quality Parts,Customers Priority,Honest Operation,and Considerate Service",our business mainly focus on the distribution of electronic components. Line cards we deal with include Microchip,ALPS,ROHM,Xilinx,Pulse,ON,Everlight and Freescale. Main products comprise IC,Modules,Potentiometer,IC Socket,Relay,Connector.Our parts cover such applications as commercial,industrial, and automotives areas.

We are looking forward to setting up business relationship with you and hope to provide you with the best service and solution. Let us make a better world for our industry!



Contact us

Tel: +86-755-8981 8866 Fax: +86-755-8427 6832

Email & Skype: info@chipsmall.com Web: www.chipsmall.com

Address: A1208, Overseas Decoration Building, #122 Zhenhua RD., Futian, Shenzhen, China



MODULAR CONNECTORS

CL 222 TM

Wire Lead Jack Type

●TM1R-616B44-*

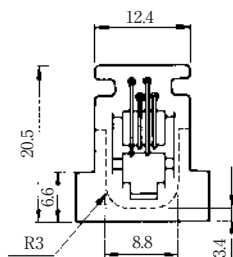
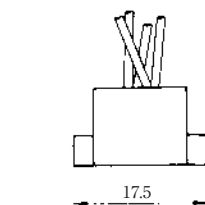
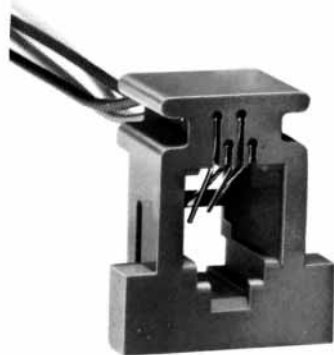

CL No.	Part No.	RoHS
222-4465-0	TM1R-616B44-35S-150M	YES

Color	L (mm)
Yellow	150
Green	150
Red	150
Black	150

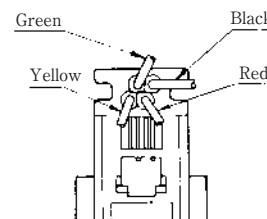
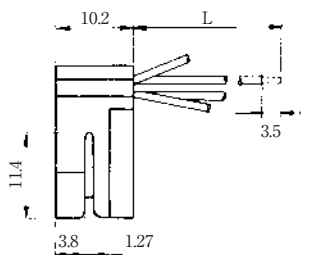

Note: Standard finish color is gray.

●TM1R-616P44-*

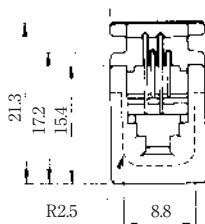
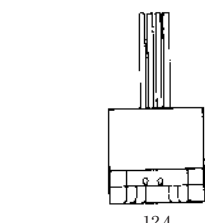
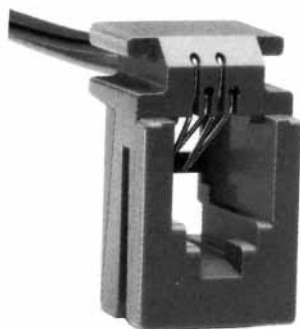

CL No.	Part No.	RoHS
222-4466-2	TM1R-616P44-35S-150M	YES

Color	L (mm)
Yellow	150
Green	150
Red	150
Black	150

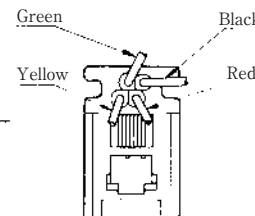
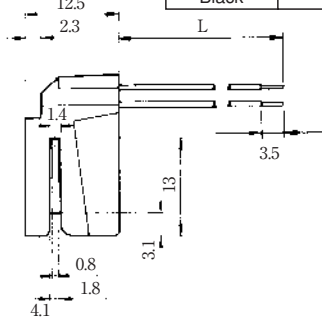

Note: Standard finish color is gray.

●TM1R-616M44-*

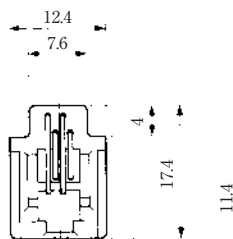
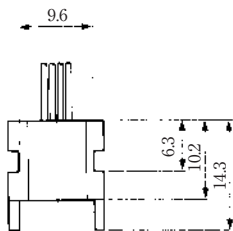

CL No.	Part No.	RoHS
222-4451-5	TM1R-616M44-35S-70M	YES

Color	L (mm)
Yellow	70
Green	70
Red	70
Black	70

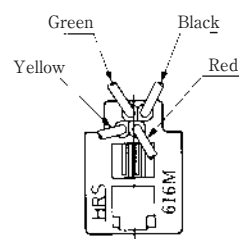
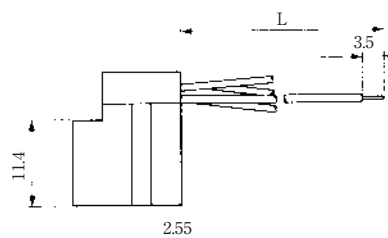

Note: Standard finish color is gray.

MODULAR CONNECTORS

CL 222 TM

• TM1R-616W44-*

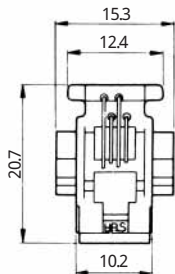
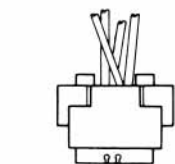
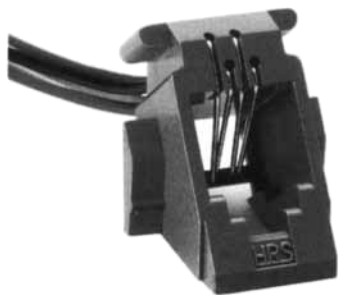

CL No.	Part No.	RoHS
222-4441-1	TM1R-616W44-4S-150M	YES

Color	L (mm)
Yellow	150
Green	150
Red	150
Black	150

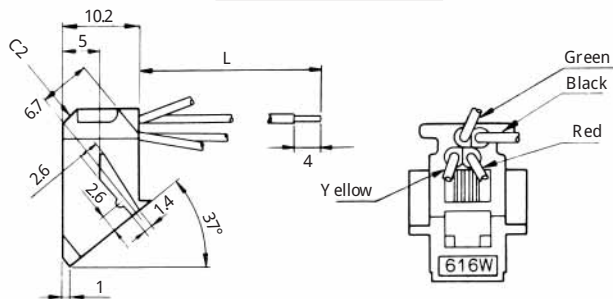

Note: Standard finish color is gray.

• TM2RD-F44-*

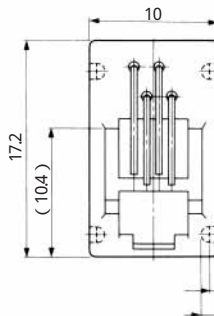
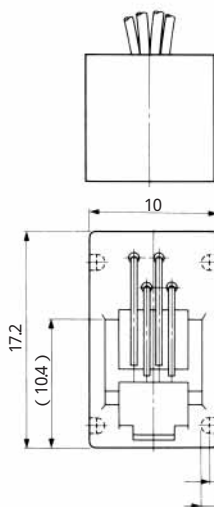

CL No.	Part No.	RoHS
222-4467-5	TM2RD-F44-4S-150M	YES

Color	L (mm)
Yellow	150
Green	150
Red	150
Black	150

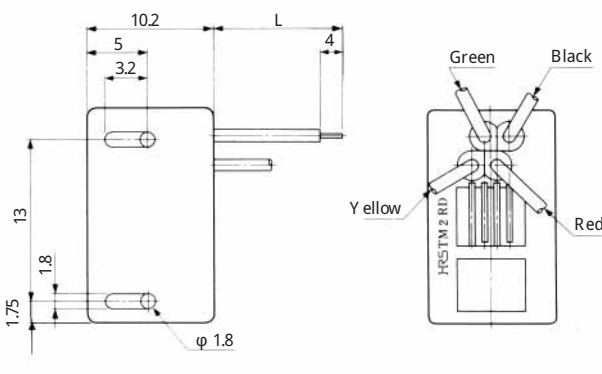

Note: Standard finish color is warm gray.

• TM2RDA-F44-*

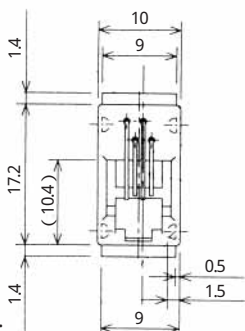
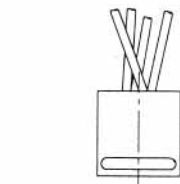
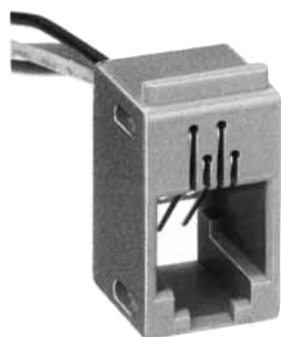

CL No.	Part No.	RoHS
CL222-4440-9	TM2RDA-F44-4S-150M	YES

Color	L (mm)
Yellow	150
Green	150
Red	150
Black	150

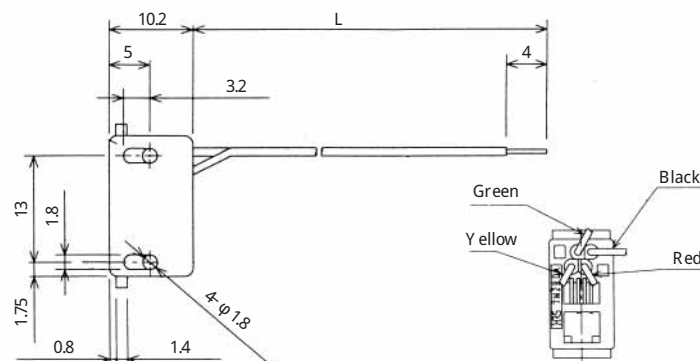

Note: Standard finish color is warm gray.

Apr. 1, 2017 Copyright 2017 HIROSE ELECTRIC CO., LTD. All Rights Reserved.

MODULAR CONNECTORS

CL 222 TM

• TM6RA-I44- *

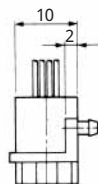
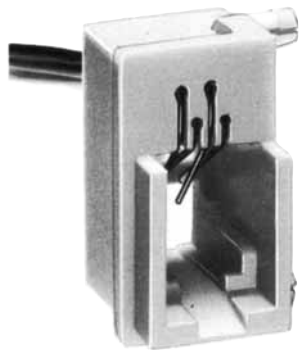

CL No.	Part No.	RoHS
222-4474-0	TM6RA-I44-35S-150M	YES

Color	L (mm)
Yellow	150
Green	150
Red	150
Black	150

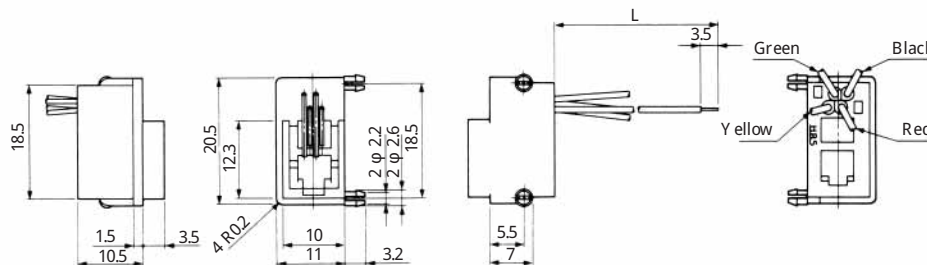

Note: Standard finish color is ash gray.

• TM1RV-623K66- *
 • TM1RV-623K64- *
 • TM1RV-623K62- *

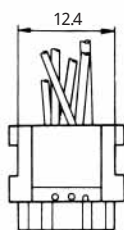
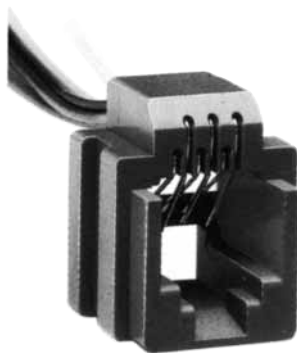

CL No.	Part No.	RoHS	CL No.	Part No.	RoHS
222-4307-9	TM1RV-623K66-4S-150M	YES	222-4473-8	TM1RV-623K64-4S-150M	YES

Color	L (mm)
White	150
Yellow	150
Green	150
Red	150
Black	150
Blue	150

Color	L (mm)
Yellow	150
Green	150
Red	150
Black	150

CL No.	Part No.	RoHS
222-4470-0	TM1RV-623K62-4S-150M	YES

Color	L (mm)
Green	150
Red	150

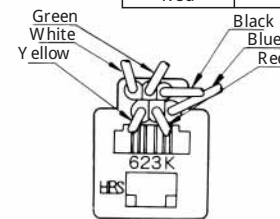
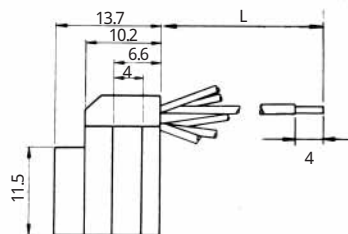
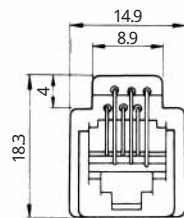

Note1: Standard finish color is gray.
 Note2: The drawing is shown sample of TM1RV-623K66- *

• TM1RV-623P66- *
 • TM1RV-623P64- *

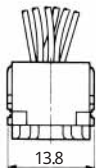
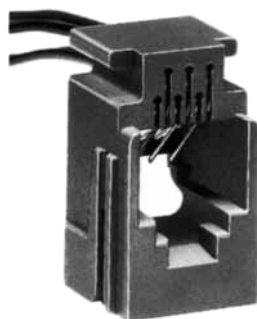

CL No.	Part No.	RoHS	CL No.	Part No.	RoHS
222-4471-2	TM1RV-623P66-35S-150M	YES	222-4425-5	TM1RV-623P64-35S-150M	YES

Color	L (mm)
White	150
Black	150
Red	150
Green	150
Yellow	150
Blue	150

Color	L (mm)
Black	150
Red	150
Green	150
Yellow	150

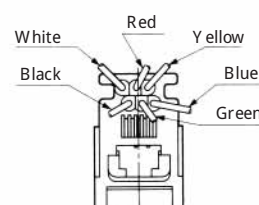
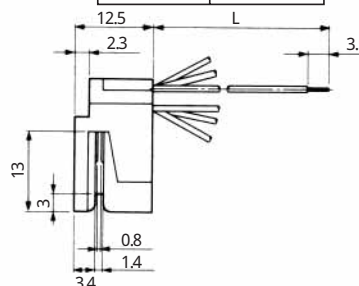
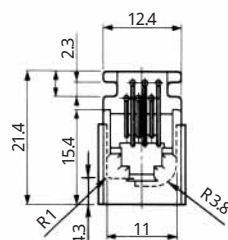

Note1: Standard finish color is gray.
 Note2: The drawing is shown sample of TM1RV-623P66- *

MODULAR CONNECTORS

CL 222 TM

● TM7RV-66-*

CL No.	Part No.	RoHS
222-4472-5	TM7RV-A66-35S-150M	YES

Color	L (mm)
White	150
Yellow	150
Green	150
Red	150
Black	150
Blue	150

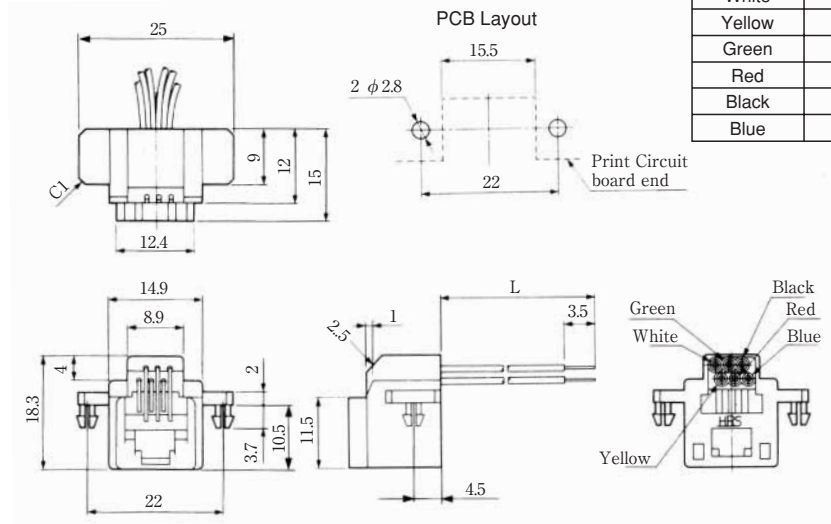
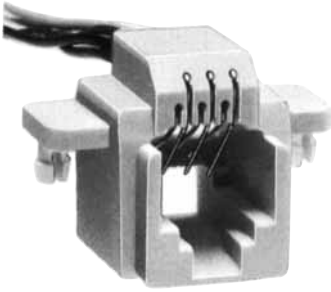

Note: Standard finish color is Vanilla white.

● TM2RGV-L66-*

● TM2RGV-L64-*

● TM2RGV-L62-*

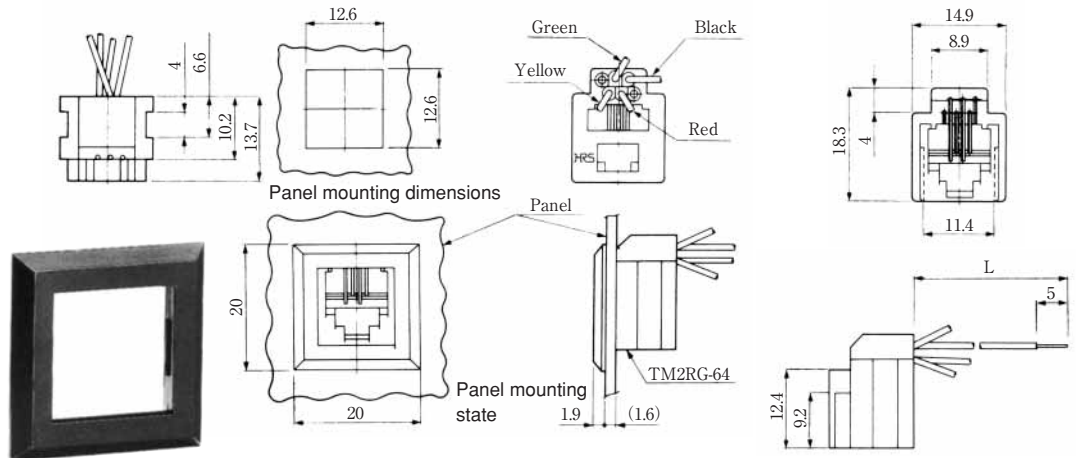

CL No.	Part No.	RoHS
222-4462-1	TM2RGV-L66-4S-150M	YES

Color	L (mm)
White	150
Yellow	150
Green	150
Red	150
Black	150
Blue	150

CL No.	Part No.	RoHS
222-4456-9	TM2RGV-L64-4S-150M	YES

Color	L (mm)
Yellow	150
Green	150
Red	150
Black	150

CL No.	Part No.	RoHS
222-4455-6	TM2RGV-L62-4S-150M	YES

Color	L (mm)
Green	150
Red	150

Note1: Standard finish color is dark brown. Note2: The drawing is shown sample of TM2RGV-L64-*

MODULAR CONNECTORS

CL 222 TM

• TM1RV-647AF88- *

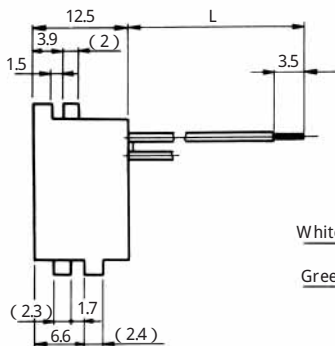
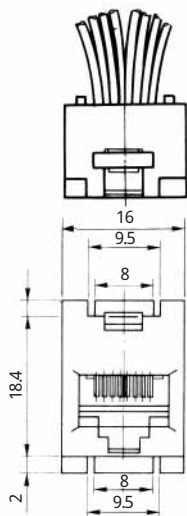
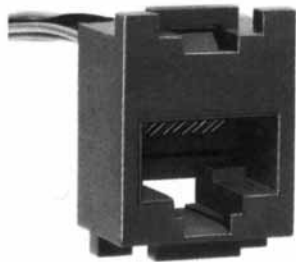

CL No.	Part No.	RoHS
222-4454-3	TM1RV647AF88-35S-150M	YES

Color	L(mm)
Brown	150
White	150
Yellow	150
Green	150
Red	150
Black	150
Blue	150
Orange	150

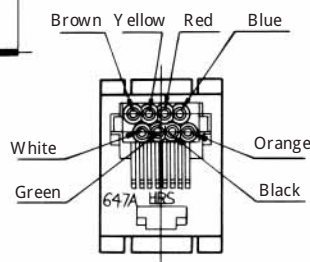

Note: Standard color is warm gray.

• TM2RC-88- *

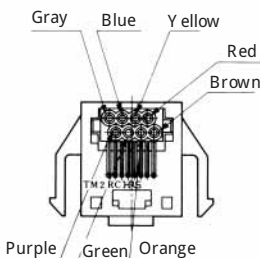
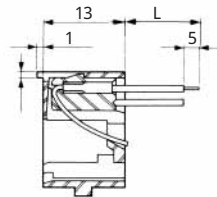
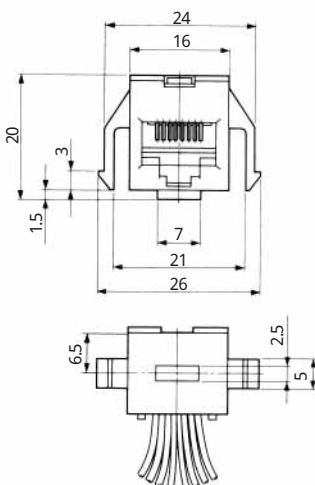
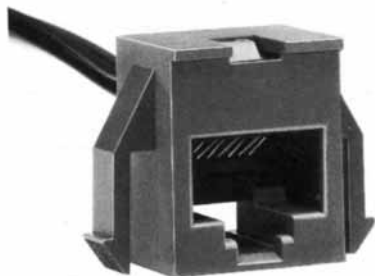

CL No.	Part No.	RoHS
222-4434-6	TM2RCV-M88-5S-450M	YES

Color	L(mm)
Gray	450
Purple	450
Blue	450
Green	450
Yellow	450
Orange	450
Red	450
Brown	450

Note: Standard finish color is beige white.