



Chipsmall Limited consists of a professional team with an average of over 10 year of expertise in the distribution of electronic components. Based in Hongkong, we have already established firm and mutual-benefit business relationships with customers from,Europe,America and south Asia,supplying obsolete and hard-to-find components to meet their specific needs.

With the principle of “Quality Parts,Customers Priority,Honest Operation,and Considerate Service”,our business mainly focus on the distribution of electronic components. Line cards we deal with include Microchip,ALPS,ROHM,Xilinx,Pulse,ON,Everlight and Freescale. Main products comprise IC,Modules,Potentiometer,IC Socket,Relay,Connector.Our parts cover such applications as commercial,industrial, and automotives areas.

We are looking forward to setting up business relationship with you and hope to provide you with the best service and solution. Let us make a better world for our industry!



## Contact us

Tel: +86-755-8981 8866 Fax: +86-755-8427 6832

Email & Skype: info@chipsmall.com Web: www.chipsmall.com

Address: A1208, Overseas Decoration Building, #122 Zhenhua RD., Futian, Shenzhen, China



# Modular Jack Connectors for High-Speed LAN Transmission

## TM21R Series

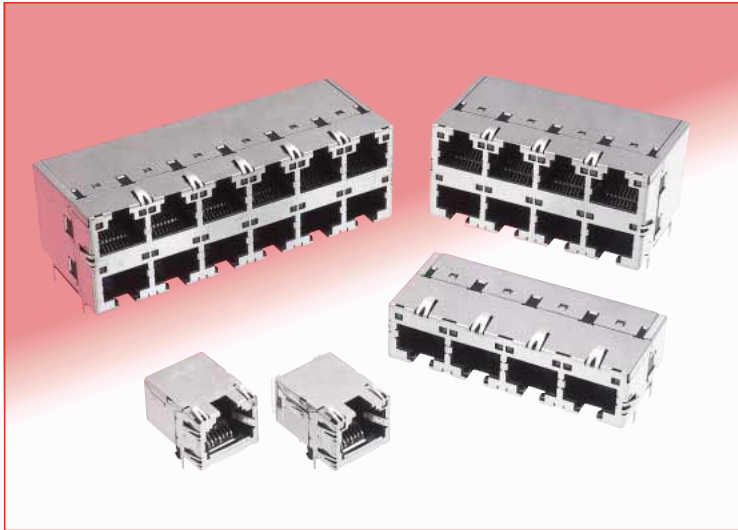

### Built-in Optical Indicators

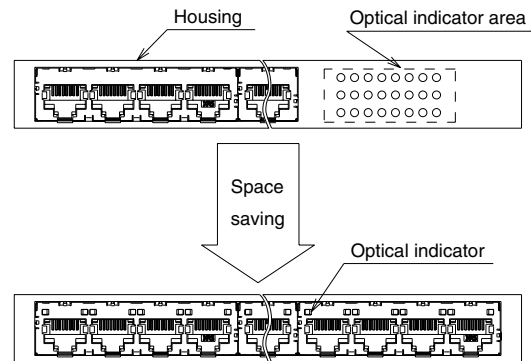
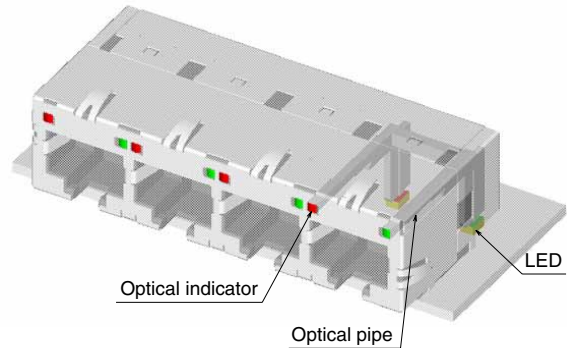

One additional TM21 multi-port jack can be mounted in the space previously occupied by LEDs.

### ■ Features

#### 1. Supports High-Speed LAN Transmission

Meets requirements of TIA/EIA-568-B data wiring standard. Single port configuration meeting CAT5e and multiple port configuration meeting CAT5 transmission performance.

As such, these products fully support Gigabit Ethernet (1000BASE-T) and Fast Ethernet (100BASE-TX) high-speed LAN transmission.

#### 2. Built-in Optical Indicators

Optical indicators are integral part of the connectors saving space on customer's board.

Compared with LED type indicators, they do not emit any electrical noise.

#### 3. EMI protection

Metal shield covers the outer surfaces of the connectors assuring complete protection against electromagnetic interference.

Built-in multiple shield and ground contacts assure reliable connection with the mounting panel as well as with the mating connector.

#### 4. FCC Standards

Meets requirements of FCC Title 47, Part 68, Subpart F.

### ■ Applications

Telecom Hubs, Routers, Bridges and ATM Transmission Equipment, Ethernet Switches and Networking Equipment, Test and Measurement Equipment, Medical Diagnostic Equipment.

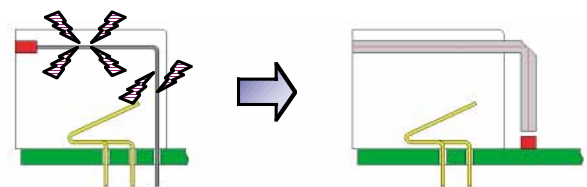

Built-in LED type  
(Possibility of  
electromagnetic noise  
emission and  
interference.)

Built-in Optical pipe  
type  
(No electromagnetic  
noise emission.)



## ■Product Specifications

Ratings	Current rating 1A	Operating temperature range-25°C to +80°C (Note)
	Voltage rating 125 V AC	

Item	Specification	Conditions
1.Insulation resistance	100 M ohms min	100 V DC
2.Dielectric Withstanding Voltage (between adjacent contacts)	No flashover or insulation breakdown	500 V AC / one minute
3.Withstanding voltage (between contact and shield)	No flashover or insulation breakdown	1500 V AC / one minute
4.Contact resistance	230 m ohms max.	100mA DC
5.Vibration	No electrical discontinuity of 5 ms or more Contact resistance: 250m ohms max.	Frequency: 10 to 55 Hz, single amplitude of 0.75 mm, 2 hours / 3 axis
6.Shock	No electrical discontinuity of 5ms or more Contact resistance: 250m ohms max.	Acceleration of 490 m/s <sup>2</sup> , 11 ms duration, sine half-wave waveform, 3 cycles in each of the 3 axis
7.Durability (mating/unmating)	Contact resistance: 250m ohms max.	200 cycles
8.Temperature cycle	Contact resistance: 250 m ohms max. Insulation resistance: 100 M ohms min.	(Temperature: -55°C→+5°C to +35°C→+85°C→+5°C to +35°C) Duration: 30 → 5 → 30 → 5 (Minutes) 5 cycles
9.Humidity	Contact resistance: 250 m ohms max. Insulation resistance: 1 M ohms min. (High humidity) Insulation resistance: 10 M ohms min. (Dry state)	500 hours at temperature of 40°C and humidity of 90% to 95%
10.Salt Spray	Contact resistance: 250 m ohms max.	Exposed to density 5% salt water for 48 hours

Note :Includes temperature rise caused by current flow.

## ■Materials

Part	Material	Finish	Remarks
Insulator	PBT	Color: Black	UL94V-0
Contact	Copper alloy	Contact area: Gold plating Termination area: Gold plating flash	—
Optical pipe	Poly carbonate	Color: Clear	—
Shield	Copper alloy	Tin plating	—

## ■Ordering information

### ●Jacks

**TM21 R - 5 A - 32 32 D - LP (50)**

① ② ③ ④ ⑤ ⑥ ⑦ ⑧ ⑨

① Series Name	TM21
② Connector type	R : Jack
③ Jack type number	5 : PCB Right-angle through hole type
④ Jack performance level code	A : CAT5 (Single row, multi-port) B : CAT5 (Double row, multi port) C : Supports CAT5e (Single port)
⑤ Jack opening code	8 : 8 contacts 32 : 8 contacts /4 ports 48 : 8 contact/6 ports
⑥ Number of inserted contacts	8 : 8 contact 32 : 8 contact inserted in 4 ports=32 contacts 48 : 8 contact inserted in 6 ports=48 contacts
⑦ Number of rows	Blank: Single row D: Double row
⑧ Optical pipe	LP: With optical pipe inserted Blank: Without optical pipe
⑨ RoHS compliant	(50)



## ◆ Recommended PCB mounting patterns

### ● With Built-in Optical Pipe

### ● Without Optical Pipe

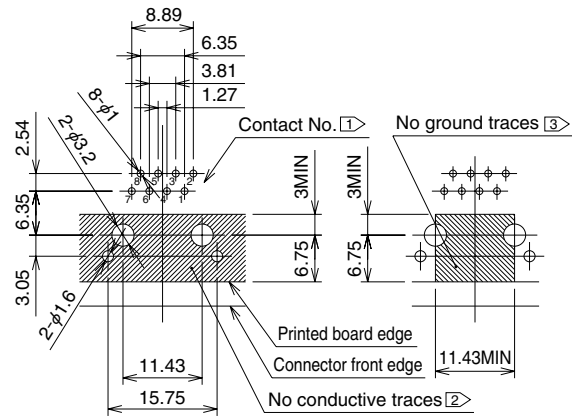
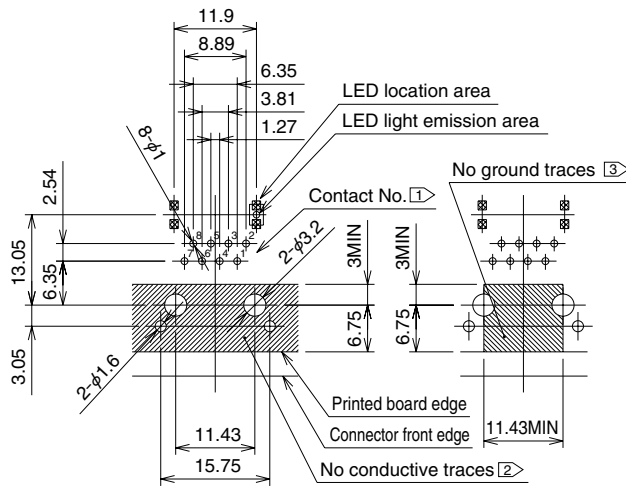

### \*Recommendations for PCB Design

- ① The contact arrangement differs between the contact area side and Printed board side. (1,2,3,4,5,6,7,8 on the contact area side → 2,1,3,4,5,6,8,7 on the printed board side)
- ② Areas indicated should be free of conductive traces.
- ③ Area indicated should be free of ground traces.
- ④ Recommended board thickness: 1.6mm.
- ⑤ To assure that the indicator light pipes operates correctly the LED's must be installed directly on the PCB, within recommended dimensions and with light emitting center in upward direction. Contact applicable manufacturer for LED specification.

#### ① PCB mounting pattern

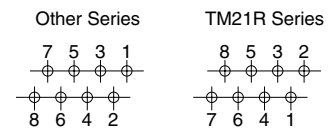

#### ⑤ Suggested LEDs

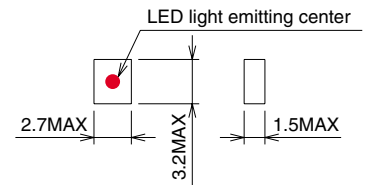

## ◆ Panel Cutout

### ● For Both Types, With and Without Built-in Optical Pipe

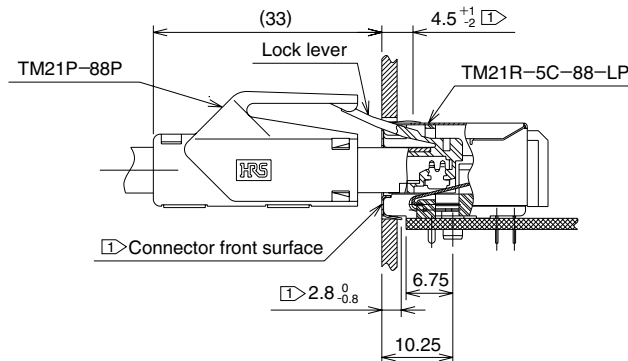
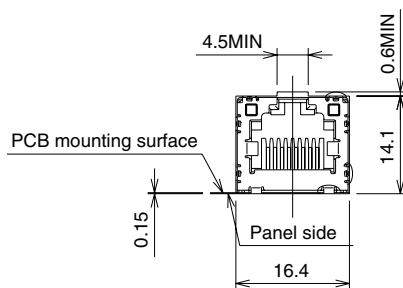

### \*Recommendations for Panel Design

- ① The shield contacts should connect with the panel cut-out on all sides.

Note: IPA cleaning at room temperature is recommended for the cleaning of this product.

When an aqueous cleaning agent is to be used, there is a concern that the light pipe (made of polycarbonate resin) may change color; therefore, please make a selection based on a table showing the effects on the resin. These tables are issued by the various manufacturers of cleaning agents.

## ■ Modular Receptacles Supporting CAT5

● Single row/ multiple ports, with Built-in Optical Pipe

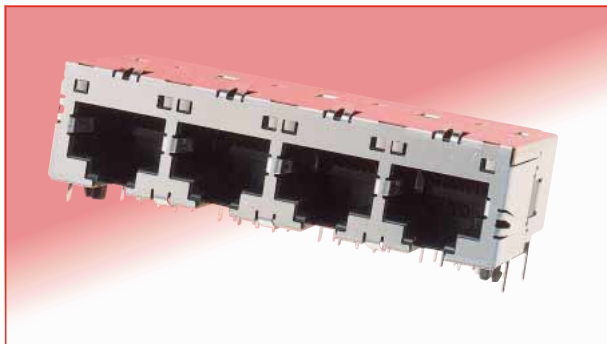

Part Number	CL No.	RoHS
TM21R-5A-3232-LP(50)	222-2873-50	YES

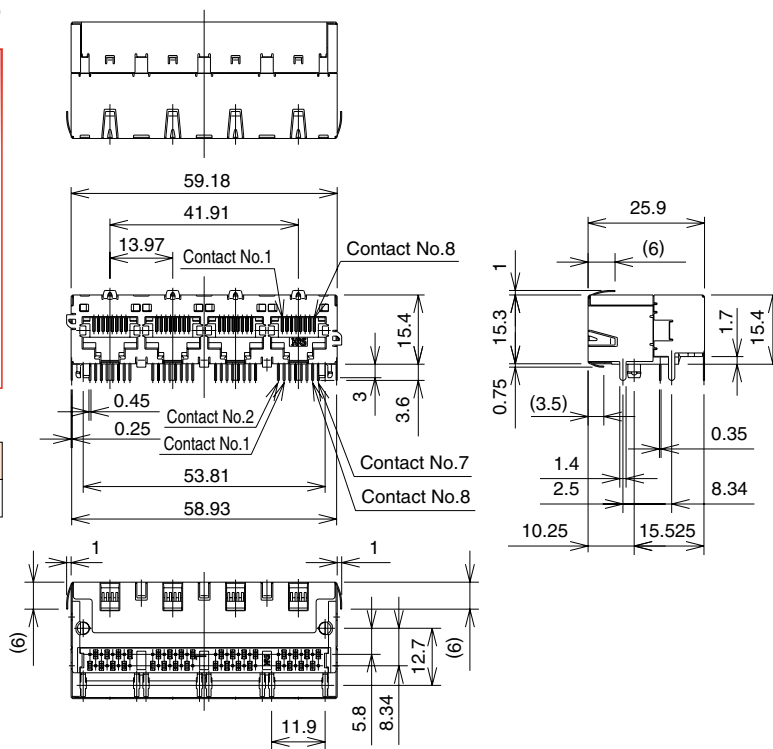

## ◆ Recommended PCB mounting patterns

### LED Mount Area Dimensions

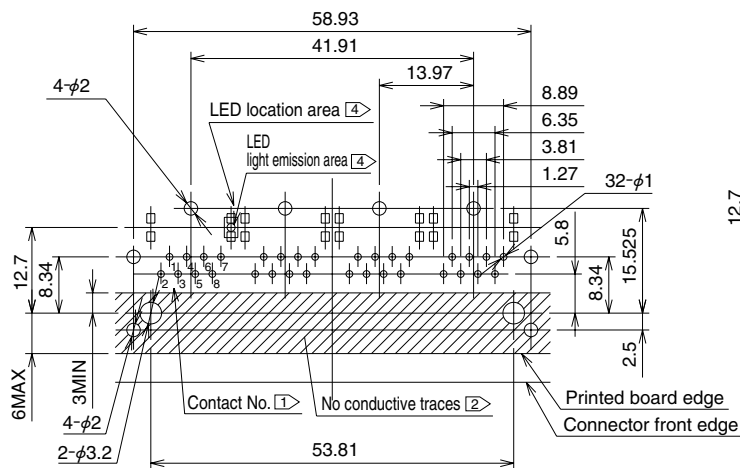

#### CL-220 Series

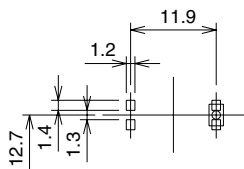

#### SML-010 Series

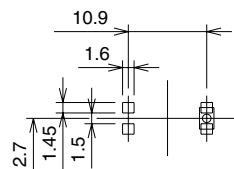

#### SML-020 Series

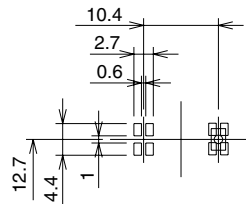

### \*Recommendations for PCB Design

- 1 The contact arrangement differs between the contact area side and Printed board side. (1,2,3,4,5,6,7,8 on the contact area side → 2,1,3,4,5,6,8,7 on the printed board side)
- 2 Areas indicated should be free of conductive traces.
- 3 Recommended board thickness: 1.6mm.
- 4 To assure that the indicator light pipe operates correctly the LED's must be installed directly on the PCB, within recommended dimensions and with light emitting center in upward direction. Contact applicable manufacturer for LED specification.

### 4 Suggested LEDs

Series Name	Manufacturer
CL-220	Citizen Electronics Co., Ltd.
SML-010	Rohm Co., LTD
SML-020	Rohm Co., LTD

### 1 PCB mounting pattern



## ◆ Recommended Panel Cutout

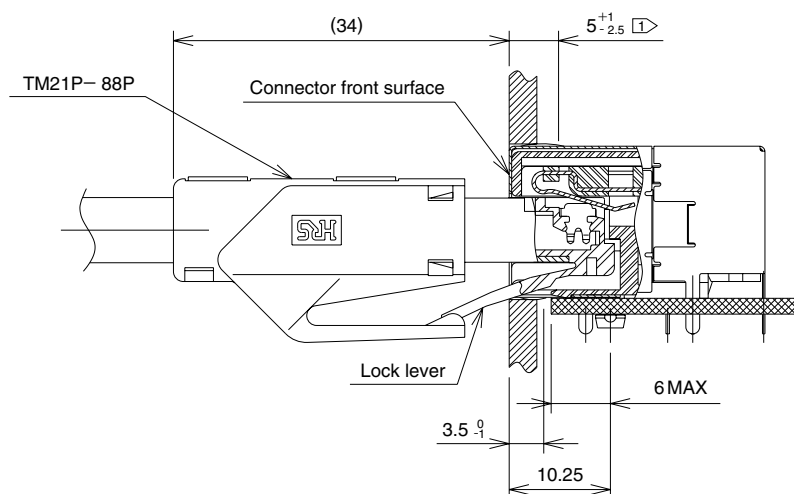
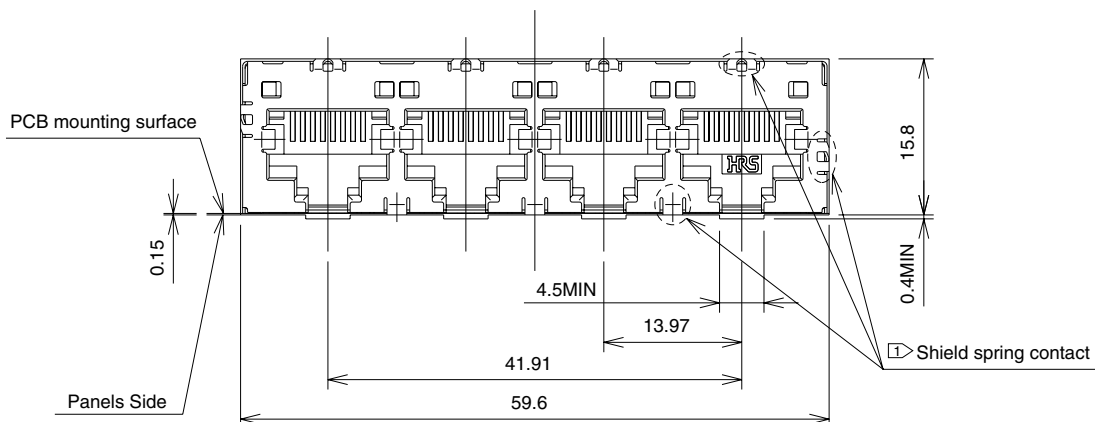

### \*Recommendations for Panel Design

① The shield contacts should connect with the panel cut-out on all sides.

Note: IPA cleaning at room temperature is recommended for the cleaning of this product.

When an aqueous cleaning agent is to be used, there is a concern that the light pipe (made of polycarbonate resin) may change color; therefore, please make a selection based on a table showing the effects on the resin. These tables are issued by the various manufacturers of cleaning agents.

● Double row / multiple port, with Built-in Optical Pipe

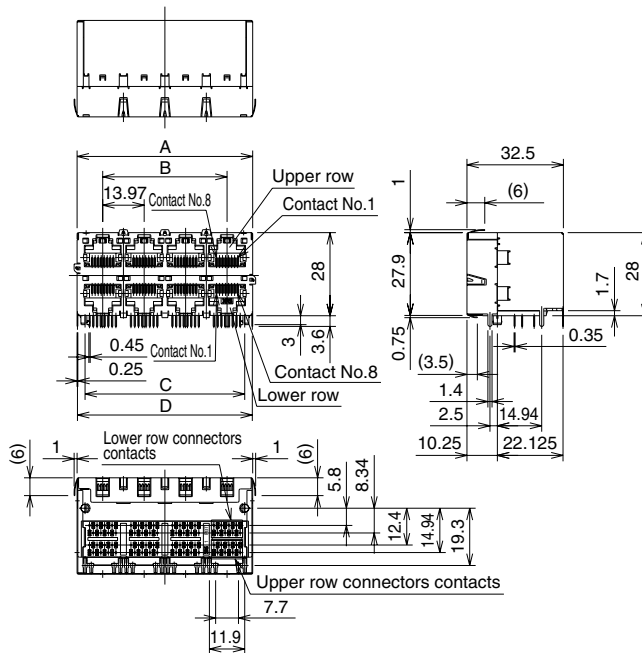
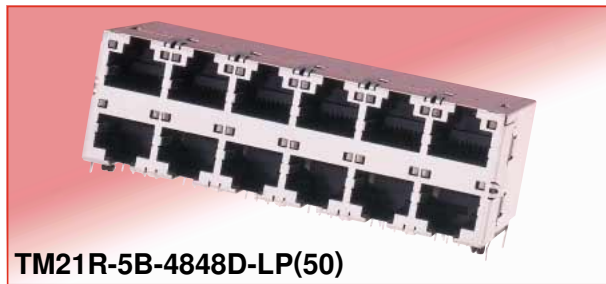

Part Number	CL No.	A	B	C	D	RoHS
TM21R-5B-3232D-LP(50)	222-2879-1-50	59.18	41.91	53.81	58.93	YES
TM21R-5B-4848D-LP(50)	222-2885-4-50	87.12	69.85	81.75	86.87	

◆ Recommended PCB mounting pattern

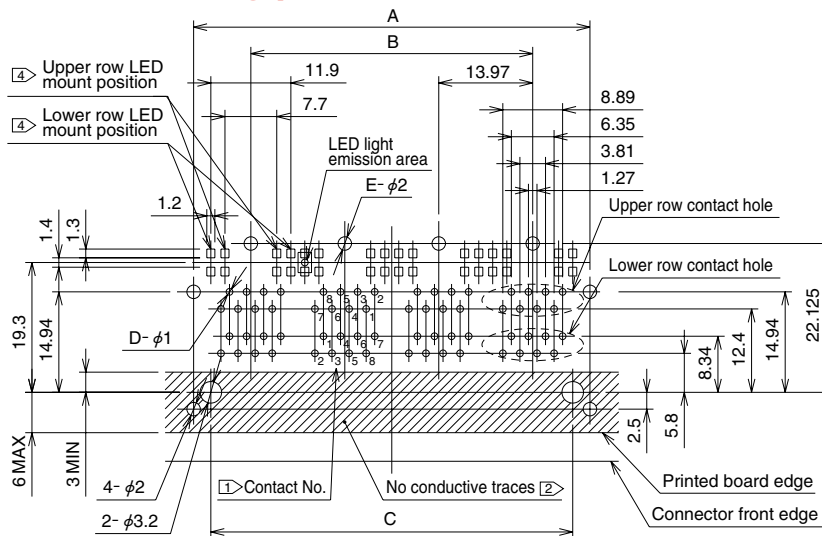

Part Number	CL No.	A	B	C	D	E
TM21R-5B-3232D-LP(50)	222-2879-1-50	58.93	41.91	53.81	64	4
TM21R-5B-4848D-LP(50)	222-2885-4-50	86.87	69.85	81.75	96	6

\*Recommendations for PCB Design

- ① The contact arrangement differs between the contact area side and Printed board side. (1,2,3,4,5,6,7,8 on the contact area side → 2,1,3,4,5,6,8,7 on the printed board side)
- ② Areas indicated should be free of conductive traces.
- ③ Recommended board thickness: 1.6mm.
- ④ To assure that the indicator light pipes operates correctly the LED's must be installed directly on the PCB, within recommended dimensions and with light emitting center in upward direction.  
Contact applicable manufacturer for LED specification.

① PCB mounting pattern

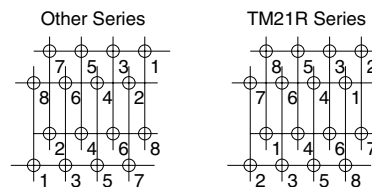

④ Suggested LEDs

Series Name	Manufacturer
CL-220	Citizen Electronics Co., Ltd.



## ◆ Panels Cutout

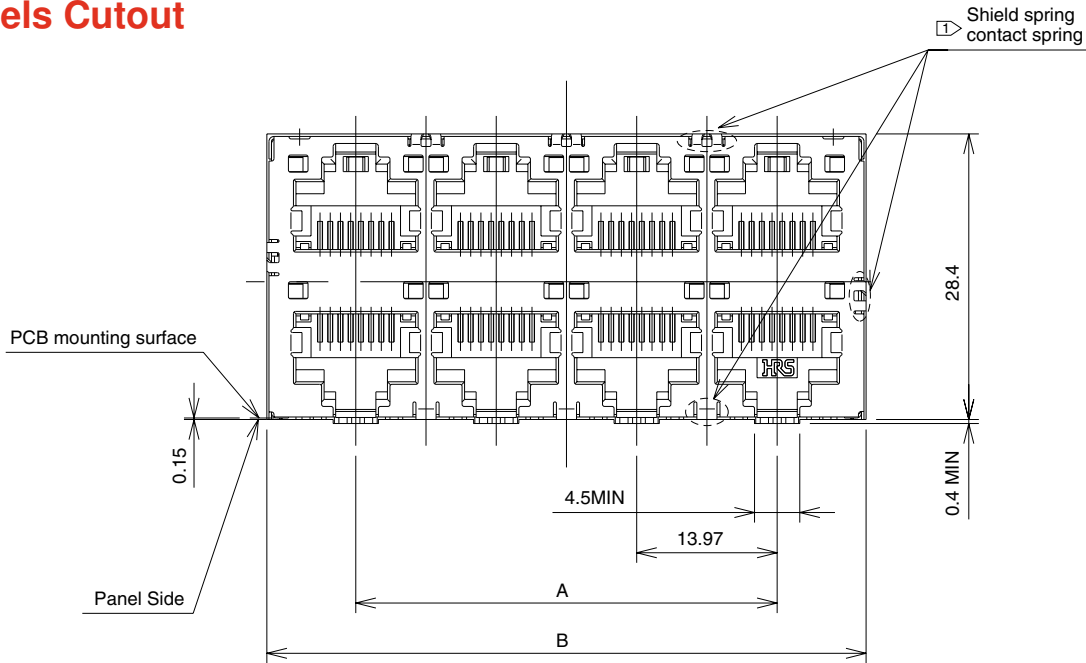

Part Number	CL No.	A	B	RoHS
TM21R-5B-3232D-LP(50)	222-2879-1-50	41.91	59.6	YES
TM21R-5B-4848D-LP(50)	222-2885-4-50	69.85	87.54	

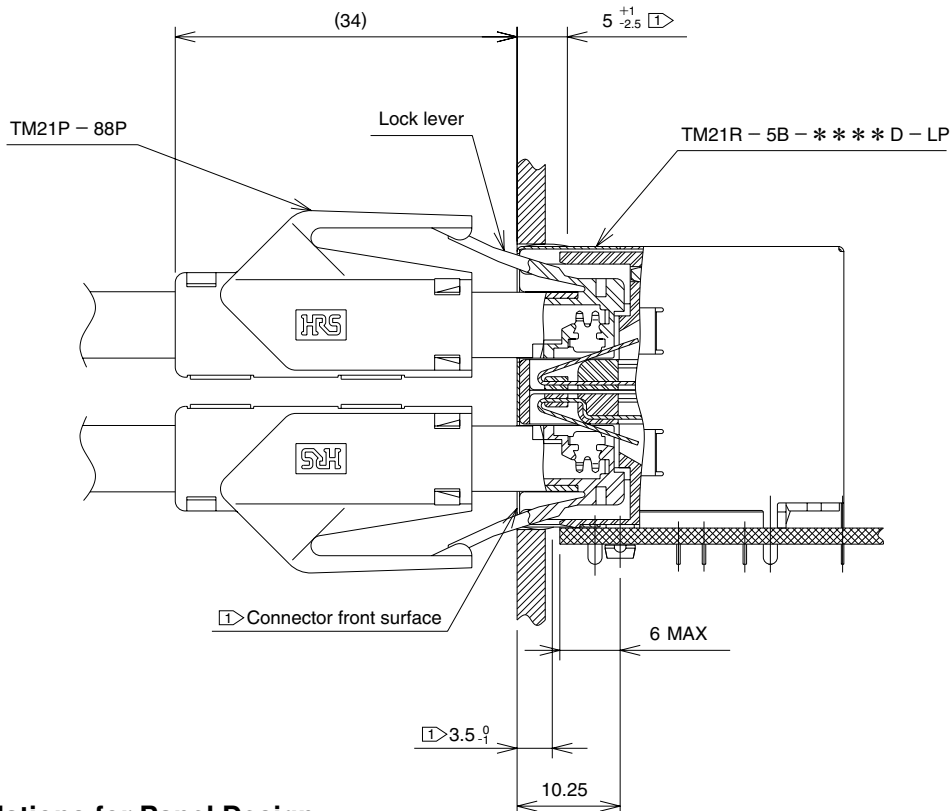

### \*Recommendations for Panel Design

① The shield contacts should connect with the panel cut-out on all sides.

Note: IPA cleaning at room temperature is recommended for the cleaning of this product.

When an aqueous cleaning agent is to be used, there is a concern that the light pipe (made of polycarbonate resin) may change color; therefore, please make a selection based on a table showing the effects on the resin. These tables are issued by the various manufacturers of cleaning agents.

## ◆ Technical Documentation CAT5e Transmission Characteristics Data

Representative values of the various transmission characteristics data for fully mated receptacle (TM21R-5C-88-LP) and plug (TM21P-88P).

All plugs in the TM21R-5C Series that were manufactured based on the De-embedded method of the TIA/EIA-568-B.2 standard and meet performance requirements of CAT5e single transmission.

Note: These data are for the listed connector combination. Inquire with your Hirose Electric account representative about other combinations.

### ● Signal Attenuation

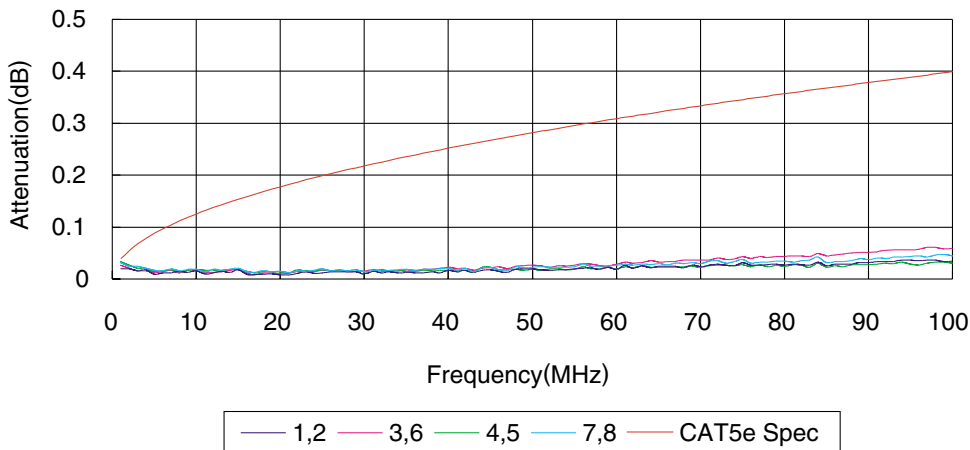

### ● Near-End Crosstalk (NEXT) Data

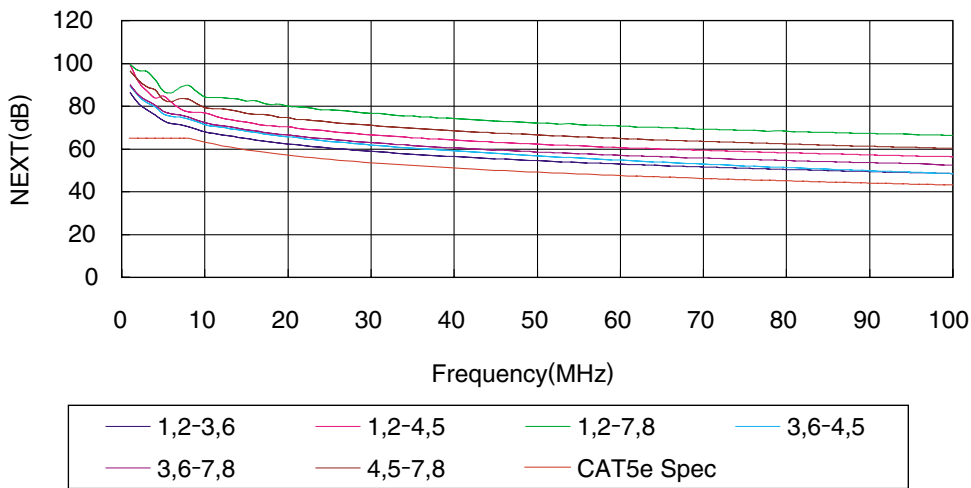

### ● Return Loss

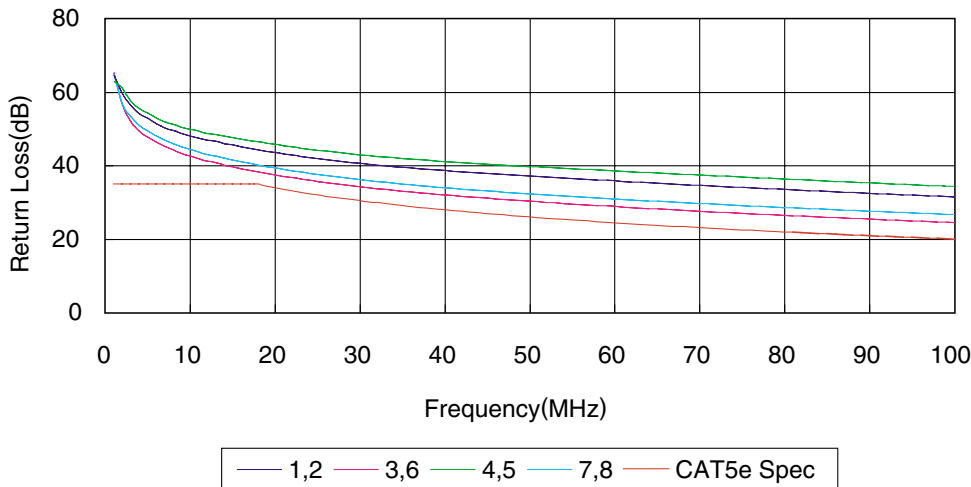

● Far-End Crosstalk (FEXT)

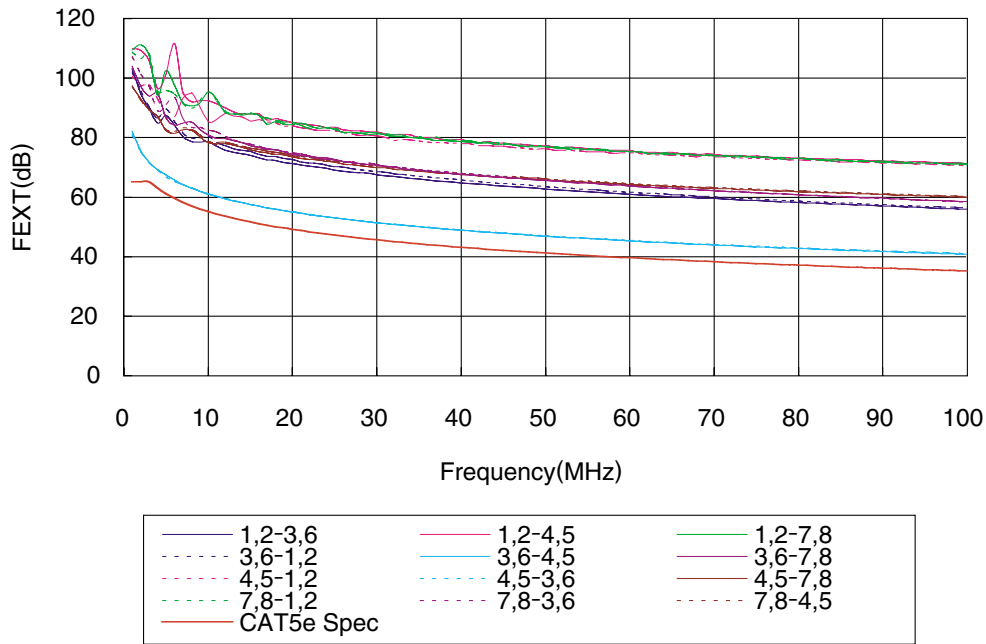

● Propagation Delay

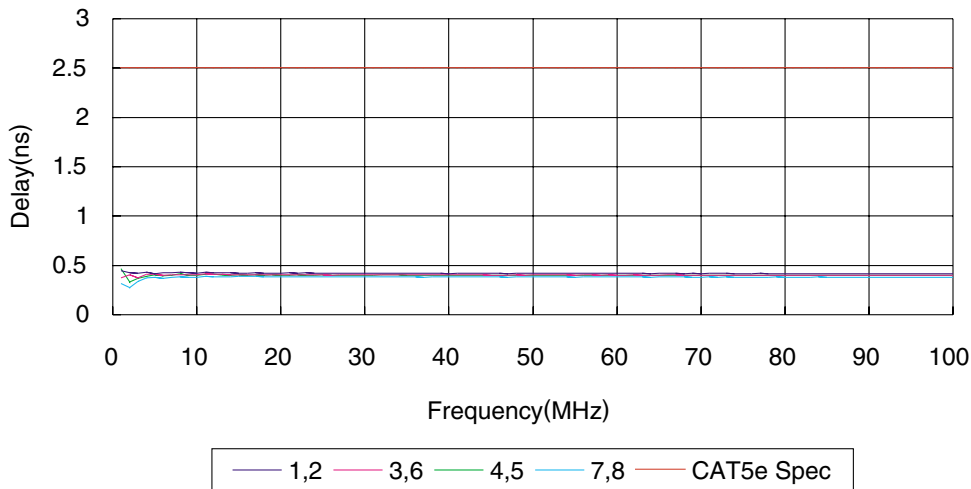

● Propagation Delay (Delay Skew)

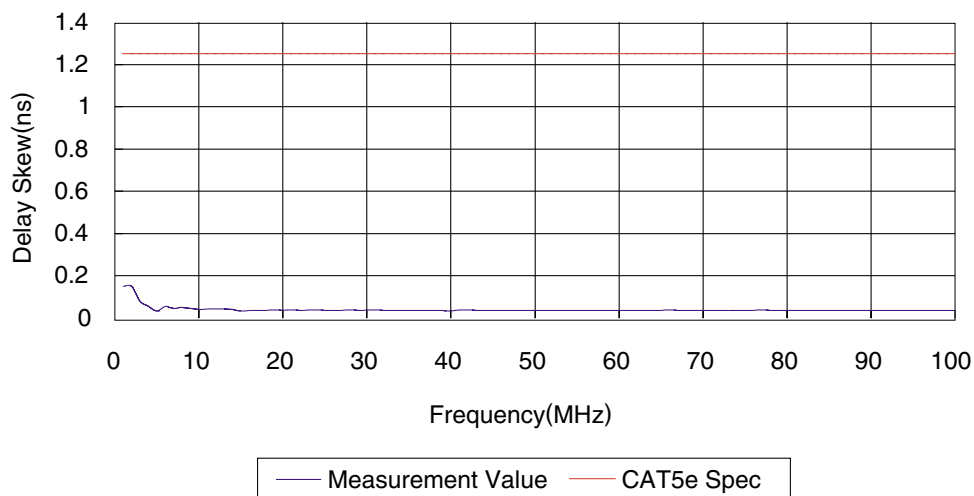

Apr.1.2017 Copyright 2017 HIROSE ELECTRIC CO., LTD. All Rights Reserved.

## ◆ Reference Documentation

### ● CAT6 Certification Received

Only the high quality plugs in the TM21R-5C Series (based on the De-embedded method of the TIA/EIA-568-B.2 standard) clear CAT6 single transmission performance. A certificate was issued by the GHMT, independent European testing company.



Certificate of Acceptance

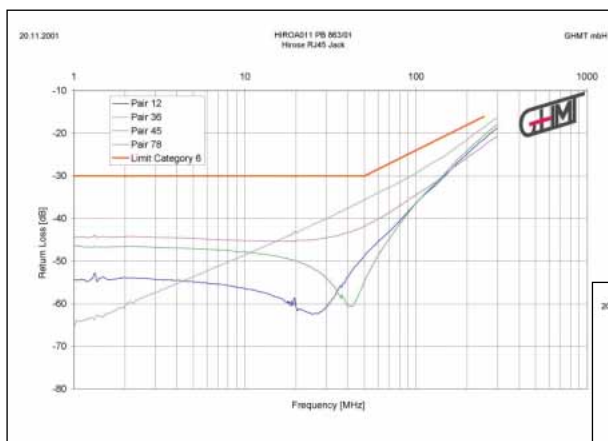

↑ Return Loss

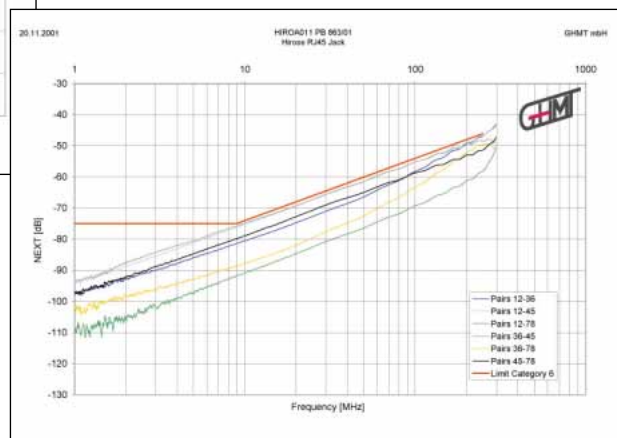

→ NEXT



# GUIDANCE FOR MODULAR CONNECTORS

## ■ Modular Connector Terminal Numbers

Unless otherwise specified, see the figures below for the terminal numbers of the product.

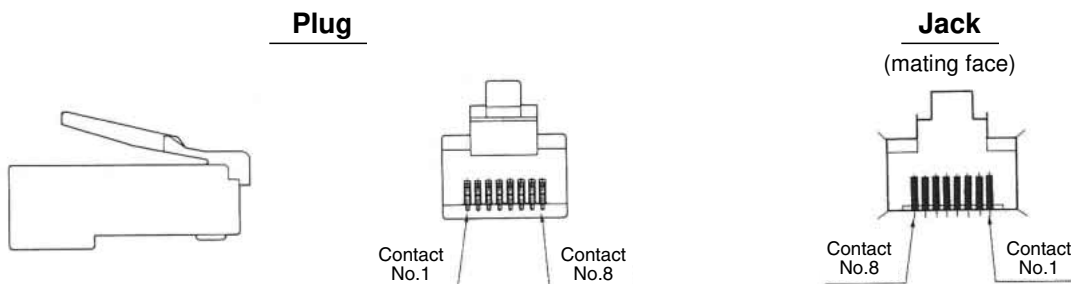

## ■ Attention to Plug Mating

Use only plugs conforming to FCC standards.  
Please pay particular attention to dimensions shown right.

### FCC PLUG DIMENSIONS

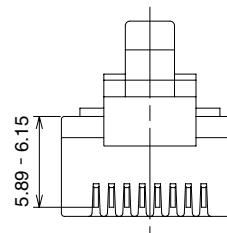

## ■ Opening Size and Number of Conductors(6-Conductor)

See the figures below for the relationship between the opening size and the number of conductors of the jack connectors.



Model 66



Model 64



Model 62

Models 64 and 62 are obtained by removing 1 pin and 2 pins, respectively, from both sides of model 66. For details, please contact us for drawings because only standard models are shown in the catalogs.

## ■ Recommended Soldering for Modular Dip Connectors

- Flow solder (automatic soldering machine)
  - Pre-heat : 90 - 130°C
  - Pre-heat time : 120 seconds maximum
  - Solder temperature : 240 - 260°C
  - Soldering time : 10 seconds maximum
- Hand soldering
  - Soldering iron tip temperature : 350°C
  - Soldering temperature : 5 seconds maximum
  - Soldering iron output : 30 - 40W

Note: When soldering, use care not to apply excessive force to the connector terminals.

- Recommended Solder composition: Paste, 96.5%Sn/3.0%Ag/0.5%Cu

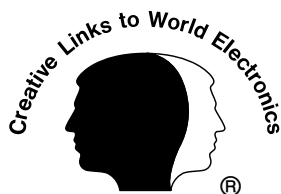

# HIROSE ELECTRIC CO.,LTD.

6-3, Nakagawa Chuoh-2-Chome, Tsuzuki-Ku, Yokohama-Shi 224-8540, JAPAN  
 TEL: +81-45-620-3526 Fax: +81-45-591-3726  
<http://www.hirose.com>  
<http://www.hirose-connectors.com>