



Chipsmall Limited consists of a professional team with an average of over 10 year of expertise in the distribution of electronic components. Based in Hongkong, we have already established firm and mutual-benefit business relationships with customers from,Europe,America and south Asia,supplying obsolete and hard-to-find components to meet their specific needs.

With the principle of “Quality Parts,Customers Priority,Honest Operation,and Considerate Service”,our business mainly focus on the distribution of electronic components. Line cards we deal with include Microchip,ALPS,ROHM,Xilinx,Pulse,ON,Everlight and Freescale. Main products comprise IC,Modules,Potentiometer,IC Socket,Relay,Connector.Our parts cover such applications as commercial,industrial, and automotives areas.

We are looking forward to setting up business relationship with you and hope to provide you with the best service and solution. Let us make a better world for our industry!



## Contact us

Tel: +86-755-8981 8866 Fax: +86-755-8427 6832

Email & Skype: info@chipsmall.com Web: www.chipsmall.com

Address: A1208, Overseas Decoration Building, #122 Zhenhua RD., Futian, Shenzhen, China



# TMC1620-TO DATASHEET

**Dual N & P-Channel 60V Power MOSFET with low on-resistance and fast switching performance**  
**High energy efficiency and good thermal performance.**

+



+

+

+

## APPLICATIONS

TMC1620-TO MOSFETs fit best with TRINAMIC bipolar stepper motor drivers:

TMC262: two-phase stepper motor driver; up to 3.5A (48V DC) or 4.5A (24V DC) RMS motor current with 4xTMC1620-TO.

TMC389: three-phase stepper motor driver; up to 3.5A (48V DC) or 4.5A (24V DC) RMS motor current with 3xTMC1620-TO.

## PRODUCT SUMMARY

	N-CH	P-CH
$BV_{DSS}$	60V	-60V
$R_{DS(ON)}$	36mΩ	75mΩ
$I_D$	6.6A	-4.7A

## DESCRIPTION

This advanced TMC1620-TO power MOSFET provides the designer with the best combination of fast switching, ruggedized device design, low on-resistance and cost-effectiveness. The highly energy efficient TMC1620 is intended for power conversion and power management applications that require high efficiency and power density.

The TO-252-4L 6.5x10mm package has a very good thermal performance.

## FEATURES AND BENEFITS

**N & P-Channel MOSFET Half Bridge Device**

**Simple Drive Requirement**

**Good Thermal Performance**

**Fast Switching Performance for quick motor reaction**

**TO-252-4L Package, 6.5x10mm**

**RoHS Compliant and Halogen-Free**

## TMC262 WITH 4X TMC1620-TO MOSFETS

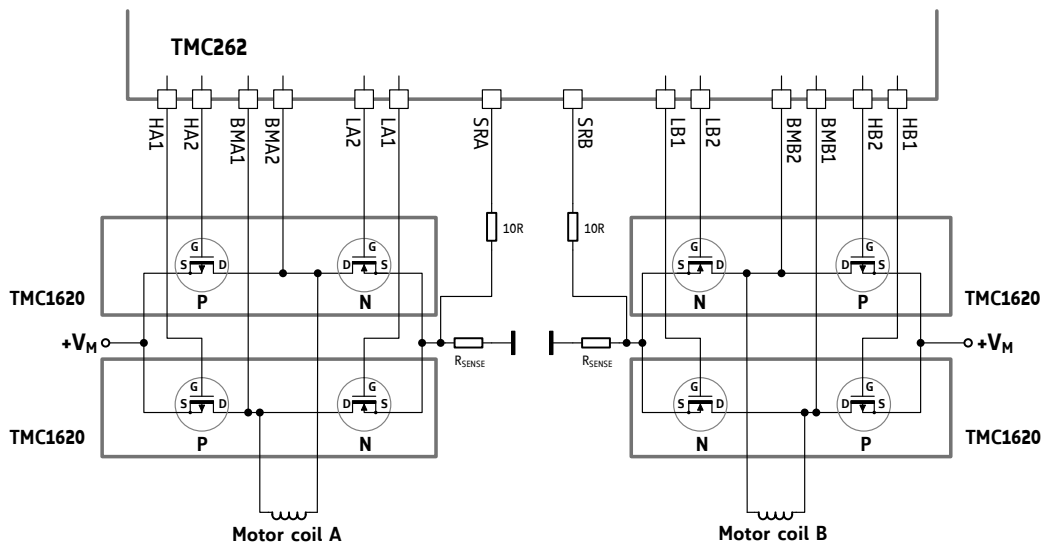

Order code	Description	Size
TMC1620-TO	N and P-channel enhancement mode power MOSFET	6.5 x 10 mm <sup>2</sup>

# Table of Contents

<b>TABLE OF CONTENTS</b> .....	<b>2</b>
<b>1 PIN ASSIGNMENTS</b> .....	<b>3</b>
<b>2 ABSOLUTE MAXIMUM RATINGS</b> .....	<b>3</b>
<b>3 THERMAL DATA</b> .....	<b>3</b>
<b>4 ELECTRICAL CHARACTERISTICS</b> .....	<b>4</b>
4.1 N-CH @T <sub>J</sub> =25°C (UNLESS OTHERWISE SPECIFIED).....	4
4.1.1 Source-Drain Diode.....	4
4.2 P-CH @T <sub>J</sub> =25°C (UNLESS OTHERWISE SPECIFIED) .....	4
4.2.1 Source-Drain Diode.....	5
<b>5 N-CHANNEL DIAGRAMS</b> .....	<b>6</b>
<b>N-CHANNEL DIAGRAMS</b> .....	<b>7</b>
<b>6 P-CHANNEL DIAGRAMS</b> .....	<b>8</b>
<b>P-CHANNEL DIAGRAMS</b> .....	<b>9</b>
<b>7 PACKAGE MECHANICAL DATA</b> .....	<b>10</b>
7.1 DIMENSIONAL DRAWINGS .....	10
7.2 PACKAGE MARKING INFORMATION AND PACKAGE CODE.....	10
<b>8 DISCLAIMER</b> .....	<b>11</b>
<b>9 ESD SENSITIVE DEVICE</b> .....	<b>11</b>
<b>10 TABLE OF FIGURES</b> .....	<b>12</b>
<b>11 REVISION HISTORY</b> .....	<b>12</b>

## 1 Pin Assignments

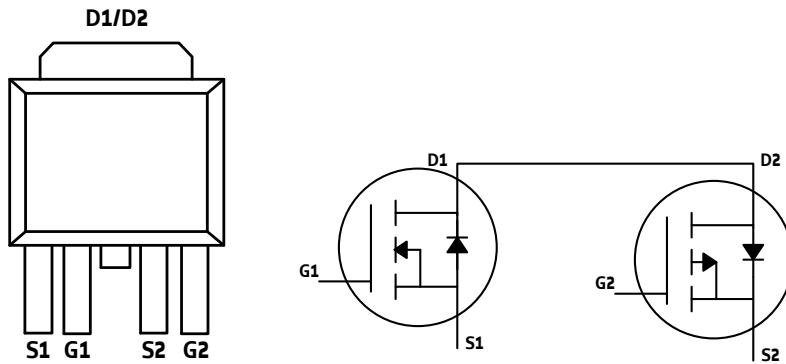

Figure 1.1 TMC1620-TO pin assignments

## 2 Absolute Maximum Ratings

The maximum ratings may not be exceeded under any circumstances. Operating the circuit at or near more than one maximum rating at a time for extended periods shall be avoided by application design.

Parameter	Symbol	N-channel	P-channel	Unit
Drain-Source Voltage	$V_{DS}$	60	-60	V
Gate-Source Voltage	$V_{GS}$	$\pm 20$	$\pm 20$	V
Continuous Drain Current* <sup>2</sup>	$I_D @ T_A = 25^\circ\text{C}$	6.6	-4.7	A
Continuous Drain Current* <sup>2</sup>	$I_D @ T_A = 70^\circ\text{C}$	5.3	-3.8	A
Pulsed Drain Current* <sup>1</sup>	$I_{DM}$	20	-20	A
Total Power Dissipation	$P_D @ T_A = 25^\circ\text{C}$	3.13		W
Storage Temperature Range	$T_{STG}$	-55 to 150		$^\circ\text{C}$
Operating Junction Temperature Range	$T_J$	-55 to 150		$^\circ\text{C}$

\*<sup>1</sup> Pulse width is limited by maximum junction temperature.

\*<sup>2</sup> N-CH, P-CH are same, mounted on 2oz FR4 board  $t \leq 10\text{s}$ .

## 3 Thermal Data

Parameter	Symbol	Value	Unit
Max. Thermal Resistance, Junction-case	Rthj-c	6	$^\circ\text{C}/\text{W}$
Max. Thermal Resistance, Junction-ambient*	Rthj-a	40	$^\circ\text{C}/\text{W}$

\* Surface mounted on 1 in<sup>2</sup> copper pad of FR4 board,  $t \leq 10\text{sec}$ ;  $85^\circ\text{C}/\text{W}$  at steady state.

## 4 Electrical Characteristics

### 4.1 N-CH @T<sub>j</sub>=25°C (unless otherwise specified)

Parameter	Symbol	Test Conditions	Min	Typ	Max	Unit
Drain-Source Breakdown Voltage	$BV_{DSS}$	$V_{GS}=0V, I_D=250\mu A$	60			V
Static Drain-Source On-Resistance*	$R_{DS(ON)}$	$V_{GS}=10V, I_D=6A$ $V_{GS}=4.5V, I_D=4A$			36 42	mΩ mΩ
Gate Threshold Voltage	$V_{GS(th)}$	$V_{DS}=V_{GS}, I_D=250\mu A$	1		3	V
Forward Transconductance	$g_{fs}$	$V_{DS}=10V, I_D=5A$		12.5		S
Drain-Source Leakage Current	$I_{DSS}$	$V_{DS}=48V, V_{GS}=0V$			10	mA
Gate-Source Leakage	$I_{GSS}$	$V_{DS}=0V, V_{GS}=\pm 20V$			±100	mA
Total Gate Charge*	$Q_g$	$I_D=5A$		12	19.2	nC
Gate-Source Charge	$Q_{gs}$	$V_{DS}=48V$		3		nC
Gate-Drain ("Miller") Charge	$Q_{gd}$	$V_{GS}=4.5V$		7		nC
Turn-on Delay Time	$t_{d(on)}$	$V_{DS}=30V$		7		ns
Rise Time	$t_r$	$I_D=5A$		10.5		ns
Turn-off Delay Time	$t_{d(off)}$	$R_G=3.3\Omega$		23		ns
Fall Time	$t_f$	$V_{GS}=10V$		5		ns
Input Capacitance	$C_{iss}$	$V_{GS}=0V$		975	1560	pF
Output Capacitance	$C_{oss}$	$V_{DS}=25V$		75		pF
Reverse Transfer Capacitance	$C_{rss}$	$f=1.0MHz$		65		pF
Gate Resistance	$R_g$	$f=1.0MHz$		1.6	3.2	Ω

\* Pulse test

#### 4.1.1 Source-Drain Diode

Parameter	Symbol	Test Conditions	Min	Typ	Max	Unit
Forward On Voltage*	$V_{SD}$	$V_{GS}=0V, I_S=2.4A$			1.3	V
Reverse Recovery Time*	$t_{rr}$	$V_{GS}=0V, I_S=5A$		23		ns
Reverse Recovery Charge	$Q_{rr}$	$dI/dt=100A/\mu s$		22		nC

\* Pulse test

### 4.2 P-CH @T<sub>j</sub>=25°C (unless otherwise specified)

Parameter	Symbol	Test Conditions	Min	Typ	Max	Unit
Drain-Source Breakdown Voltage	$BV_{DSS}$	$V_{GS}=0V, I_D=-250\mu A$	-60			V
Static Drain-Source On-Resistance*	$R_{DS(ON)}$	$V_{GS}=-10V, I_D=-4A$ $V_{GS}=-4.5V, I_D=-3A$			75 90	mΩ mΩ
Gate Threshold Voltage	$V_{GS(th)}$	$V_{DS}=V_{GS}, I_D=-250\mu A$	-1		-3	V
Forward Transconductance	$g_{fs}$	$V_{DS}=-10V, I_D=-3A$		11		S
Drain-Source Leakage Current	$I_{DSS}$	$V_{DS}=-48V, V_{GS}=0V$			-10	mA
Gate-Source Leakage	$I_{GSS}$	$V_{DS}=0V, V_{GS}=\pm 20V$			±100	mA
Total Gate Charge*	$Q_g$	$I_D=-3A$		14	22.4	nC
Gate-Source Charge	$Q_{gs}$	$V_{DS}=-48V$		2.5		nC
Gate-Drain ("Miller") Charge	$Q_{gd}$	$V_{GS}=-4.5V$		8		nC
Turn-on Delay Time*	$t_{d(on)}$	$V_{DS}=-30V$		9		ns
Rise Time	$t_r$	$I_D=-3A$		9.5		ns
Turn-off Delay Time	$t_{d(off)}$	$R_G=3.3\Omega$		42		ns
Fall Time	$t_f$	$V_{GS}=-10V$		28		ns
Input Capacitance	$C_{iss}$	$V_{GS}=0V$		1000	1600	pF
Output Capacitance	$C_{oss}$	$V_{DS}=-25V$		125		pF
Reverse Transfer Capacitance	$C_{rss}$	$f=1.0MHz$		95		pF
Gate Resistance	$R_g$	$f=1.0MHz$		1.6	3.2	Ω

\* Pulse test

## 4.2.1 Source-Drain Diode

Parameter	Symbol	Test Conditions	Min	Typ	Max	Unit
Forward On Voltage*	$V_{SD}$	$V_{GS}=0V, I_S=-2.4A$			-1.3	V
Reverse Recovery Time	$t_{rr}$	$V_{GS}=0V, I_S=-3A$		30		ns
Reverse Recovery Charge	$Q_{rr}$	$dI/dt=-100A/\mu s$		45		nC

\* Pulse test

## 5 N-Channel Diagrams

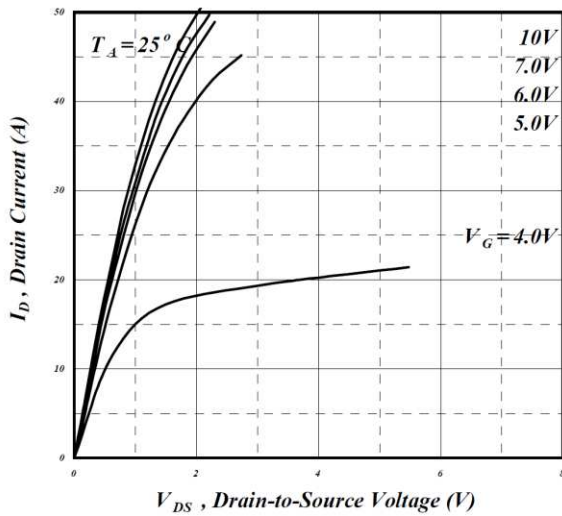

Figure 5.1 Typical output characteristics

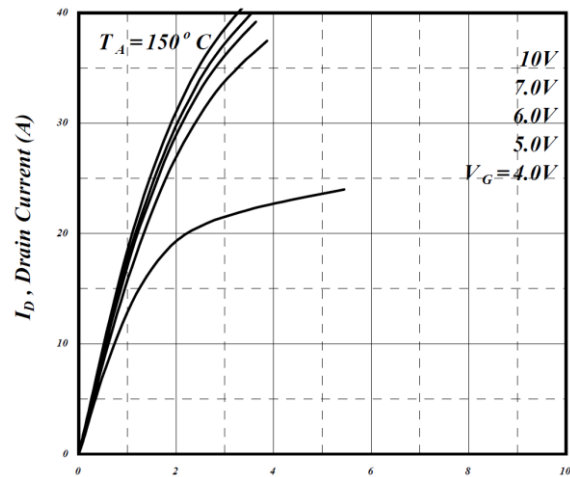

Figure 5.2 Typical output characteristics

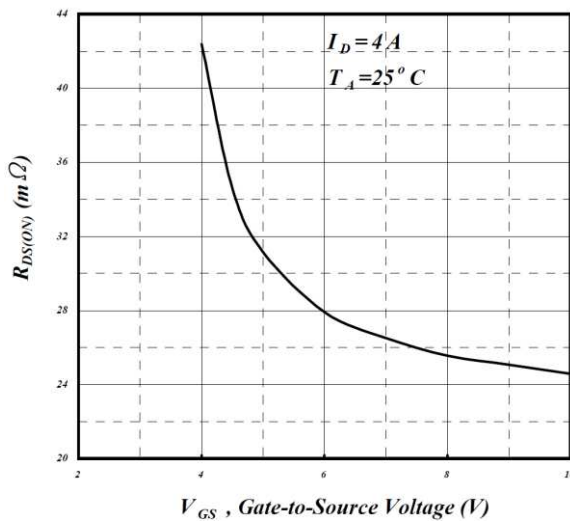

Figure 5.3 On-resistance v.s. gate voltage

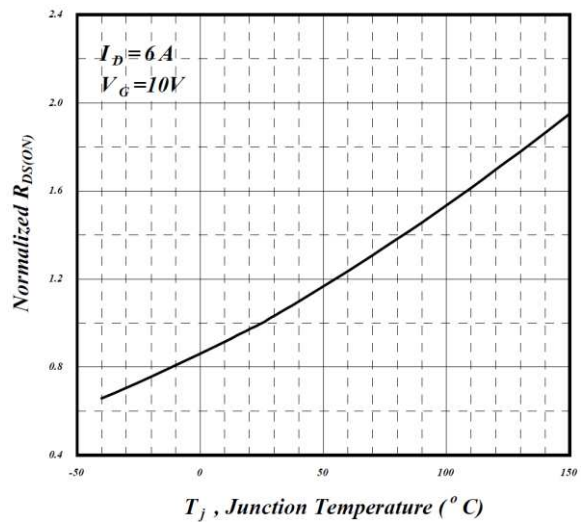

Figure 5.4 Normalized on-resistance v.s. junction temperature

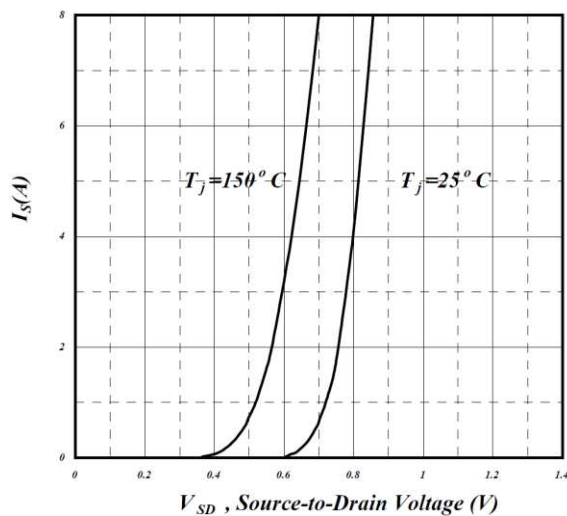

Figure 5.5 Forward characteristic of reverse diode

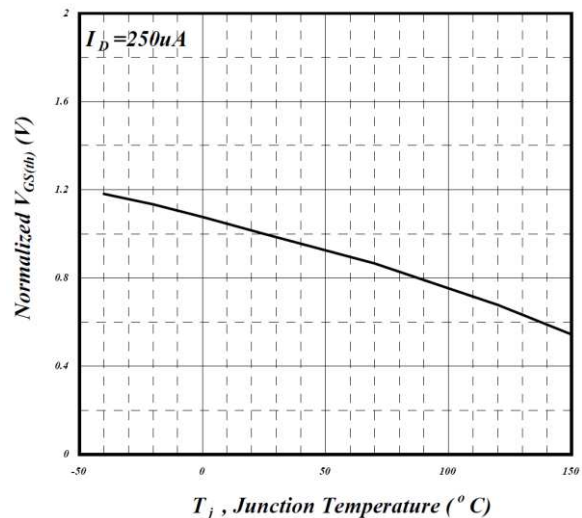

Figure 5.6 Gate threshold voltage v.s. junction temperature

# N-Channel Diagrams

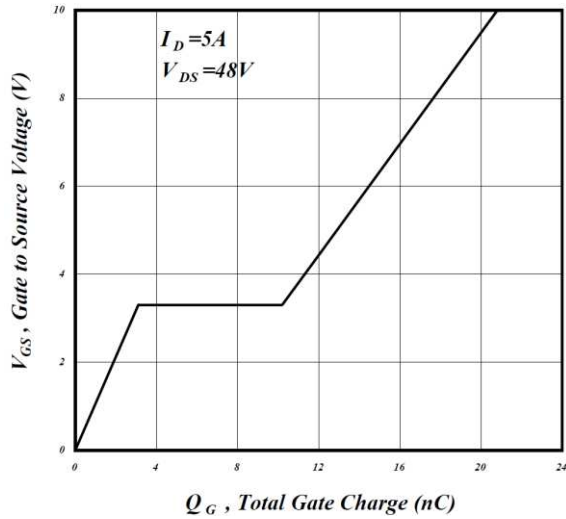

Figure 5.7 Gate charge characteristics

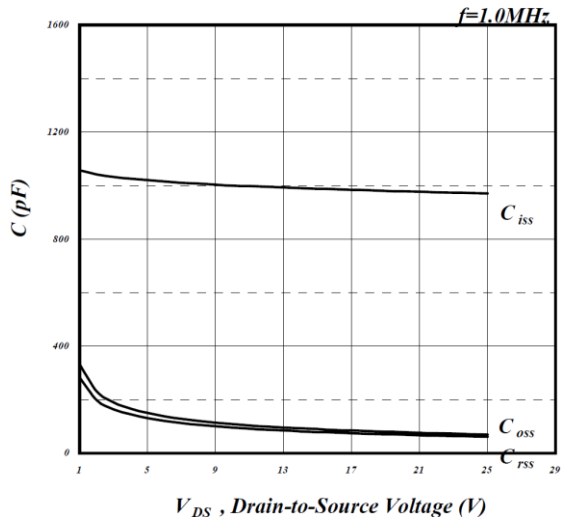

Figure 5.8 Typical capacitance characteristics

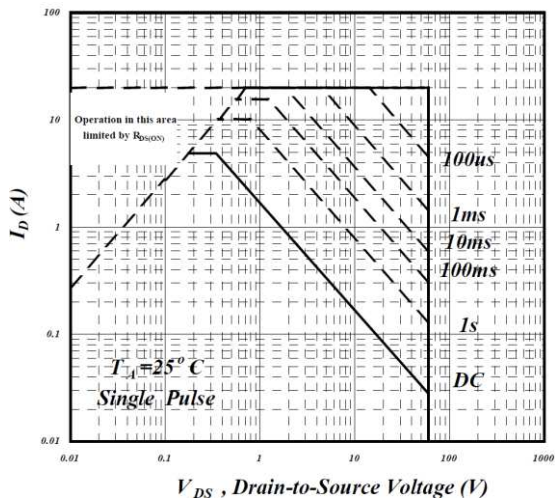

Figure 5.9 Maximum safe operating area

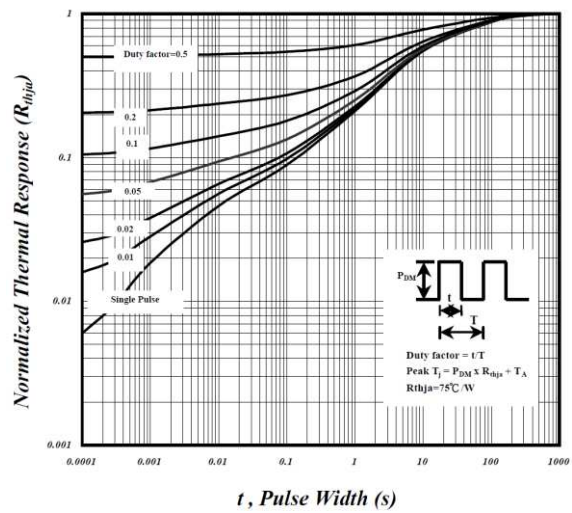

Figure 5.10 Effective transient thermal impedance

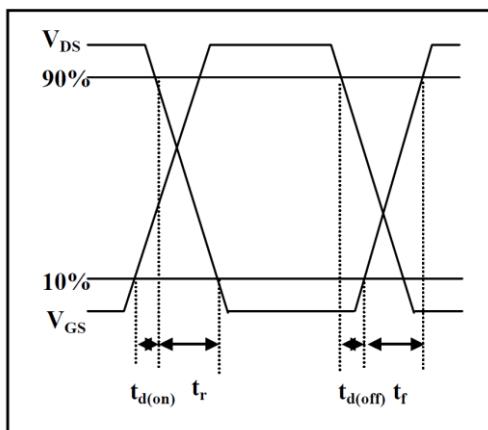

Figure 5.11 Switching time waveform

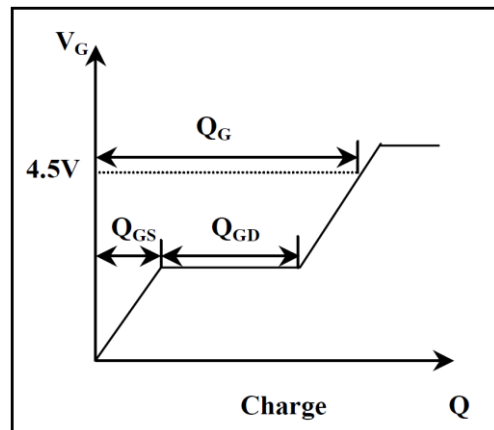

Figure 5.12 Gate charge waveform



## 6 P-Channel Diagrams

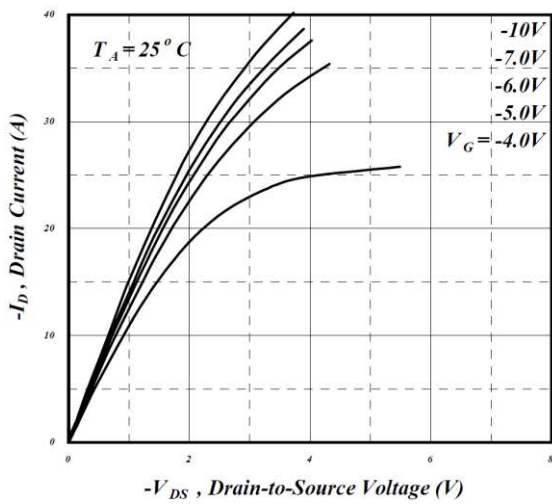

Figure 6.1 Typical output characteristics

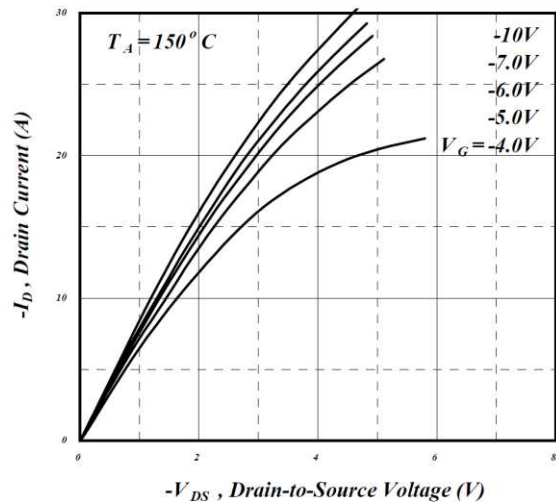

Figure 6.2 Typical output characteristics

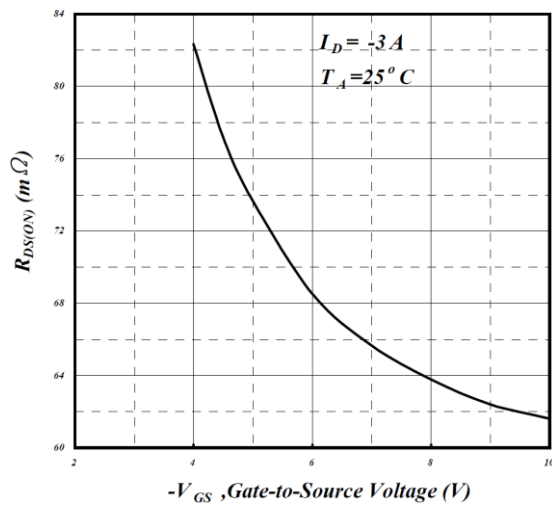

Figure 6.3 On-resistance v.s. gate voltage

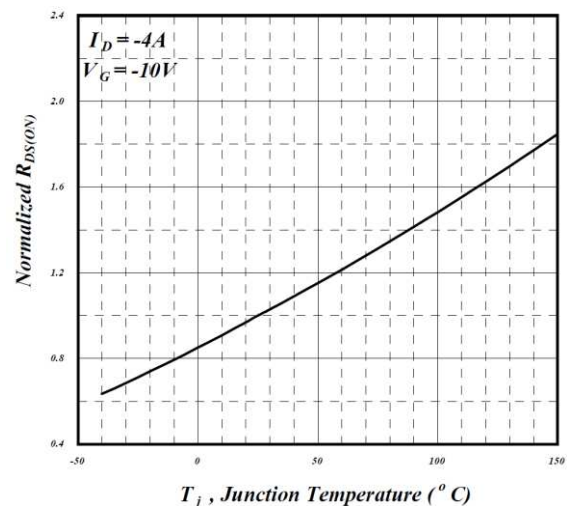

Figure 6.4 Normalized on-resistance v.s. junction temperature

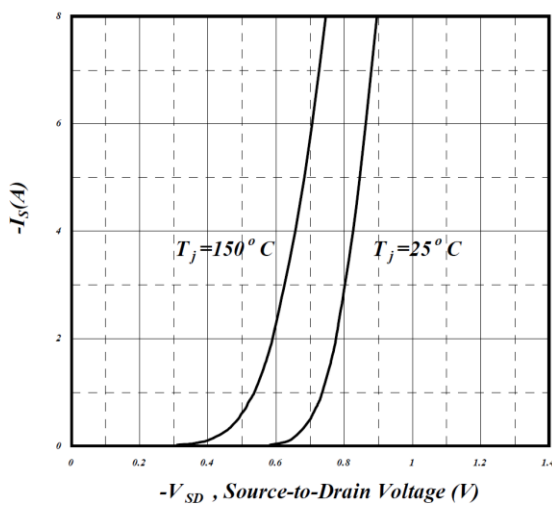

Figure 6.5 Forward characteristic of reverse diode

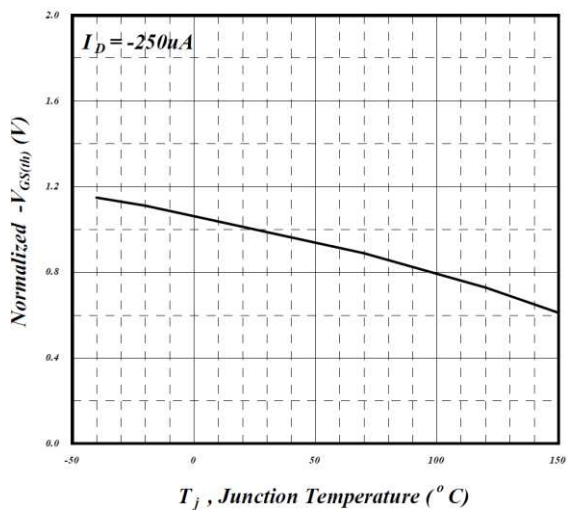

Figure 6.6 Gate Threshold voltage v.s. junction temperature

# P-Channel Diagrams

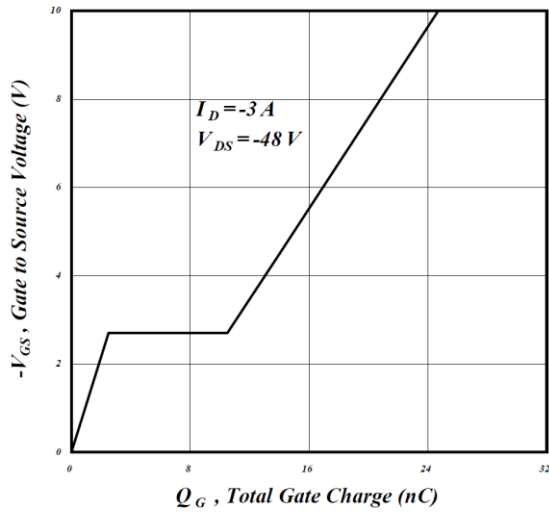

Figure 6.7 Gate charge characteristics

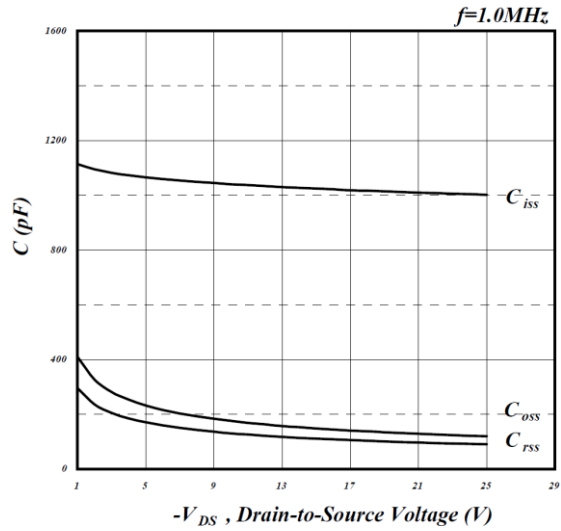

Figure 6.8 Typical capacitance characteristics

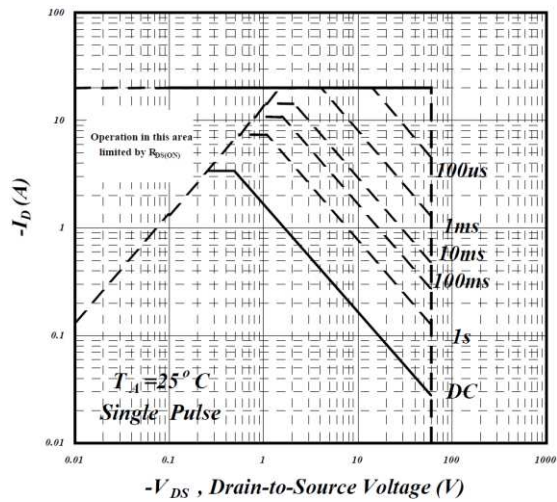

Figure 6.9 Maximum safe operating area

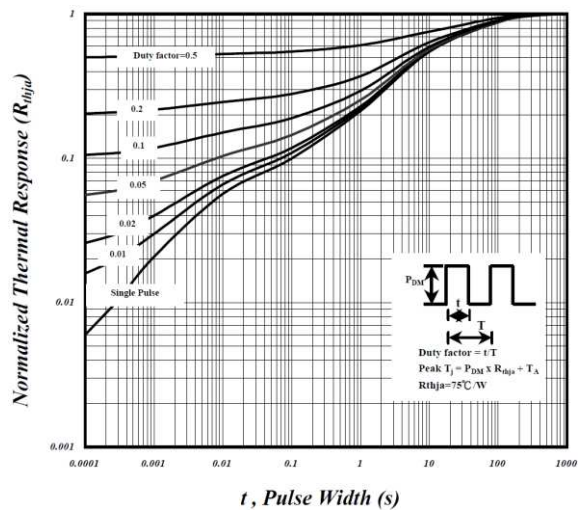

Figure 6.10 Effective transient thermal impedance

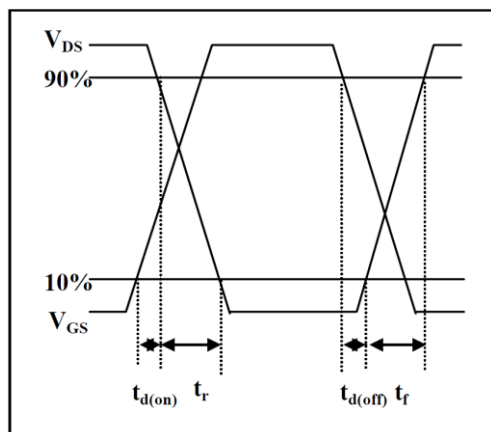

Figure 6.11 Switching time waveform

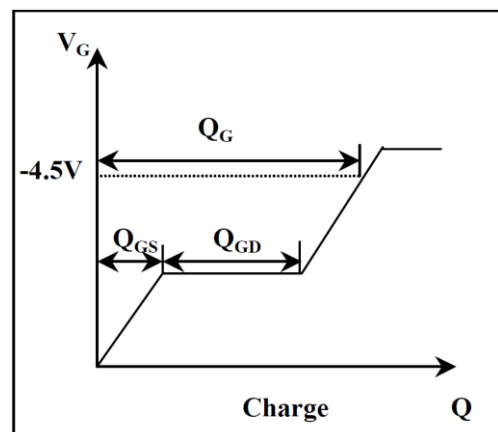

Figure 6.12 Gate charge waveform

## 7 Package Mechanical Data

### 7.1 Dimensional Drawings

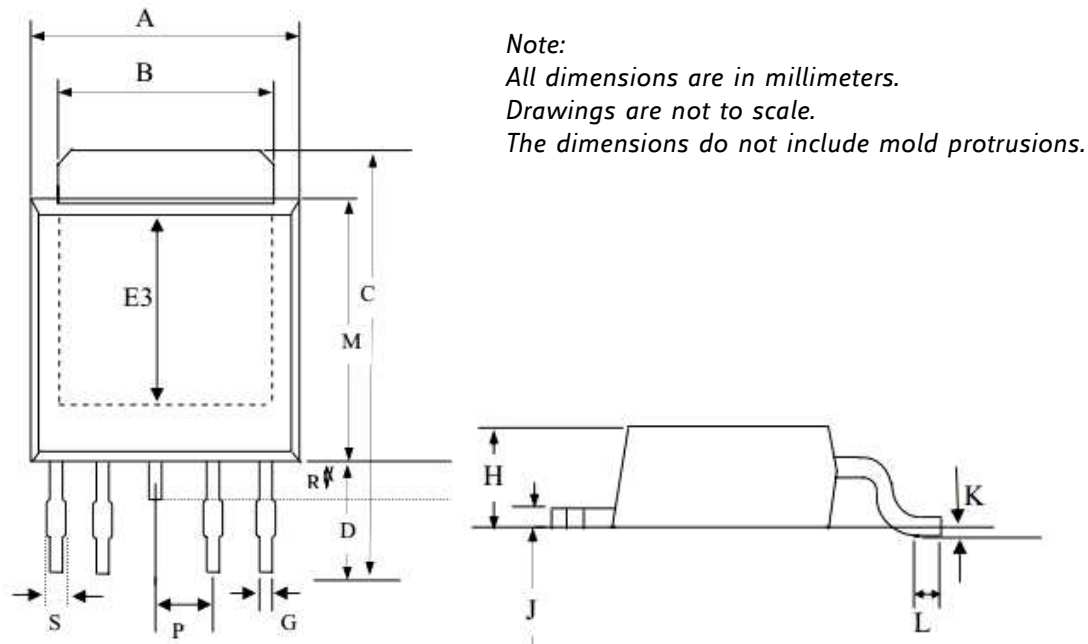

Figure 7.1 Dimensional drawings

Symbols	Min	Nom	Max
A	6.40	6.60	6.80
B	5.20	5.35	5.50
C	9.40	9.80	10.20
D	2.40	2.70	3.00
P	1.27 REF.		
S	0.50	0.65	0.80
E3	3.50	4.00	4.50
R	0.80	1.00	1.20
G	0.40	0.50	0.60
H	2.20	2.30	2.40
J	0.45	0.50	0.55
K	0.00	0.075	0.15
L	0.90	1.20	1.50
M	5.40	5.60	5.80

### 7.2 Package Marking Information and Package Code

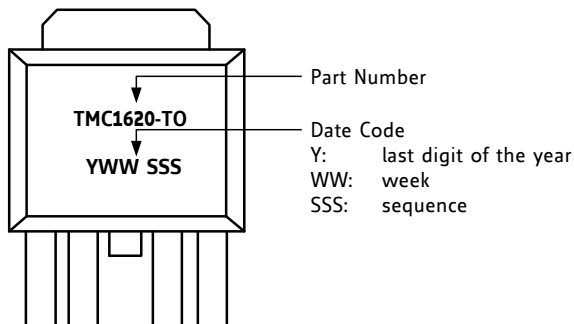

Figure 7.2 Package marking information

Device	Package	Temperature range	Code/ Marking
TMC1620	TO-252-4L package 6.5x10	-55° to +150°C	TMC1620-TO

## 8 Disclaimer

TRINAMIC Motion Control GmbH & Co. KG does not authorize or warrant any of its products for use in life support systems, without the specific written consent of TRINAMIC Motion Control GmbH & Co. KG. Life support systems are equipment intended to support or sustain life, and whose failure to perform, when properly used in accordance with instructions provided, can be reasonably expected to result in personal injury or death.

Information given in this data sheet is believed to be accurate and reliable. However no responsibility is assumed for the consequences of its use nor for any infringement of patents or other rights of third parties which may result from its use.

Specifications are subject to change without notice.

All trademarks used are property of their respective owners.

## 9 ESD Sensitive Device

The TMC1620-TO is an ESD sensitive CMOS device sensitive to electrostatic discharge. Take special care to use adequate grounding of personnel and machines in manual handling. After soldering the devices to the board, ESD requirements are more relaxed. Failure to do so can result in defect or decreased reliability.



## 10 Table of Figures

Figure 1.1 TMC1620 pin assignments.....	3
Figure 5.1 Typical output characteristics.....	6
Figure 5.2 Typical output characteristics.....	6
Figure 5.3 On-resistance v.s. gate voltage.....	6
Figure 5.4 Normalized on-resistance v.s. junction temperature .....	6
Figure 5.5 Forward characteristic of reverse diode .....	6
Figure 5.6 Gate threshold voltage v.s. junction temperature.....	6
Figure 5.7 Gate charge characteristics .....	7
Figure 5.8 Typical capacitance characteristics.....	7
Figure 5.9 Maximum safe operating area .....	7
Figure 5.10 Effective transient thermal impedance .....	7
Figure 5.11 Switching time waveform .....	7
Figure 5.12 Gate charge waveform.....	7
Figure 6.1 Typical output characteristics.....	8
Figure 6.2 Typical output characteristics.....	8
Figure 6.3 On-resistance v.s. gate voltage.....	8
Figure 6.4 Normalized on-resistance v.s. junction temperature .....	8
Figure 6.5 Forward characteristic of reverse diode .....	8
Figure 6.6 Gate Threshold voltage v.s. junction temperature .....	8
Figure 6.7 Gate charge characteristics .....	9
Figure 6.8 Typical capacitance characteristics.....	9
Figure 6.9 Maximum safe operating area .....	9
Figure 6.10 Effective transient thermal impedance .....	9
Figure 6.11 Switching time waveform .....	9
Figure 6.12 Gate charge waveform.....	9
Figure 7.1 Dimensional drawings .....	10
Figure 7.2 Package marking information .....	10

## 11 Revision History

Version	Date	Author SD - Sonja Dwersteg	Description
0.90	2014-FEB-26	SD	Initial version
1.00	2014-MAR-18	SD	New front picture, thermal data corrected
1.01	2014-MAY-12	SD	RMS motor current in combination with TMC262 and TMC389 updated.