



Chipsmall Limited consists of a professional team with an average of over 10 year of expertise in the distribution of electronic components. Based in Hongkong, we have already established firm and mutual-benefit business relationships with customers from,Europe,America and south Asia,supplying obsolete and hard-to-find components to meet their specific needs.

With the principle of “Quality Parts,Customers Priority,Honest Operation,and Considerate Service”,our business mainly focus on the distribution of electronic components. Line cards we deal with include Microchip,ALPS,ROHM,Xilinx,Pulse,ON,Everlight and Freescale. Main products comprise IC,Modules,Potentiometer,IC Socket,Relay,Connector.Our parts cover such applications as commercial,industrial, and automotives areas.

We are looking forward to setting up business relationship with you and hope to provide you with the best service and solution. Let us make a better world for our industry!



Contact us

Tel: +86-755-8981 8866 Fax: +86-755-8427 6832

Email & Skype: info@chipsmall.com Web: www.chipsmall.com

Address: A1208, Overseas Decoration Building, #122 Zhenhua RD., Futian, Shenzhen, China



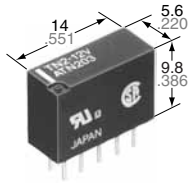

mm inch

FEATURES

- Small header area makes higher density mounting possible
- High sensitivity: 140 mW nominal operating power (single side stable 3-12 V type)

- Surge voltage withstand: 1500 V FCC Part 68
- Self-clinching terminal also available

RoHS Directive compatibility information
<http://www.nais-e.com/>

SPECIFICATIONS

Contact

Arrangement	2 Form C	
Initial contact resistance, max. (By voltage drop 6 V DC 1A)	60 mΩ	
Contact material	Gold-clad silver	
Rating	Nominal switching capacity (resistive load)	1 A 30 V DC, 0.5 A 125 V AC
	Max. switching power (resistive load)	30 W, 62.5 VA
	Max. switching voltage	110 V DC, 125 V AC
	Max. switching current	1 A
	Min. switching capacity (Reference value) ^{#1}	10 μA 10 mV DC
Nominal operating power	Single side stable	140 mW (3 to 12 V DC) 200 mW (24 V DC) 300 mW (48 V DC)
	1 coil latching	100 mW (3 to 12 V DC) 150 mW (24 V DC)
	2 coil latching	200 mW (3 to 12 V DC) 300 mW (24 V DC)
Expected life (min. operations)	Mechanical (at 180 cpm)	10 ⁸
	Electrical (at 20 cpm)	1 A 30 V DC resistive load: 2 × 10 ⁵ 0.5 A 125 V AC resistive load: 10 ⁵

Note:

#1 This value can change due to the switching frequency, environmental conditions, and desired reliability level, therefore it is recommended to check this with the actual load. (SX relays are available for low level load switching [10V DC, 10mA max. level])

Remarks

- * Specifications will vary with foreign standards certification ratings.
- *1 Measurement at same location as "Initial breakdown voltage" section.
- *2 By resistive method, nominal voltage applied to the coil; contact carrying current: 1 A.
- *3 Nominal voltage applied to the coil, excluding contact bounce time.
- *4 Nominal voltage applied to the coil, excluding contact bounce time without diode.

Characteristics

Initial insulation resistance*1		Min. 1,000 MΩ (at 500 V DC)
Initial breakdown voltage	Between open contacts	750 Vrms for 1 min. (Detection current: 10 mA)
	Between contact and coil	1,000 Vrms for 1 min. (Detection current: 10 mA)
	Between contact sets	1,000 Vrms for 1 min. (Detection current: 10 mA)
FCC surge voltage between open contacts		1,500 V
Temperature rise*2 (at 20°C)		Max. 50°C
Operate time [Set time]*3 (at 20°C)		Max. 3 ms [Max. 3 ms]
Release time [Reset time]*4 (at 20°C)		Max. 3 ms [Max. 3 ms]
Shock resistance	Functional*5	Min. 490 m/s ² {50G}
	Destructive*6	Min. 980 m/s ² {100G}
Vibration resistance	Functional*7	176.4 m/s ² {18G}, 10 to 55 Hz at double amplitude of 3 mm
	Destructive	294 m/s ² {30G}, 10 to 55 Hz at double amplitude of 5 mm
Conditions for operation, transport and storage*8 (Not freezing and condensing at low temperature)	Ambient temperature	-40°C to +70°C -40°F to +158°F
	Humidity	5 to 85% R.H.
Unit weight		Approx. 1.5 g .053 oz

*5 Half-wave pulse of sine wave: 11 ms; detection time: 10 μs.

*6 Half-wave pulse of sine wave: 6 ms.

*7 Detection time: 10 μs.

*8 Refer to 6. Conditions for operation, transport and storage mentioned in AMBIENT ENVIRONMENT .

ORDERING INFORMATION

Ex. TN 2 — L2 — H — 12V

Contact arrangement	Operating function	Terminal shape	Coil voltage(DC)
2: 2 Form C	Nil: Single side stable L: 1 coil latching L2: 2 coil latching	Nil: Standard PC board terminal H: Self-clinching terminal	3,4.5,5,6,9,12, 24,48*V

*48 V coil type: Single side stable only

Note: AgPd stationary contact types available for high resistance against contact sticking.

When ordering, please add suffix “-3” like TN2-12V-3.

TYPES AND COIL DATA (at 20°C 68°F)

1. Single side stable

Part No.		Nominal voltage, V DC	Pick-up voltage, V DC (max.)	Drop-out voltage, V DC (min.)	Nominal operating current, mA (±10%)	Coil resistance, Ω (±10%)	Nominal operating power, mW	Max. allowable voltage, V DC
Standard PC board terminal	Self-clinching terminal							
TN2-3 V	TN2-H-3 V	3	2.25	0.3	46.7	64.3	140	4.5
TN2-4.5 V	TN2-H-4.5 V	4.5	3.38	0.45	31.1	145	140	6.7
TN2-5 V	TN2-H-5 V	5	3.75	0.5	28.1	178	140	7.5
TN2-6 V	TN2-H-6 V	6	4.5	0.6	23.3	257	140	9
TN2-9 V	TN2-H-9 V	9	6.75	0.9	15.5	579	140	13.5
TN2-12 V	TN2-H-12 V	12	9	1.2	11.7	1,028	140	18
TN2-24 V	TN2-H-24 V	24	18	2.4	8.3	2,880	200	36
TN2-48 V	TN2-H-48 V	48	36	4.8	6.25	7,680	300	57.6

2. 1 Coil latching

Part No.		Nominal voltage, V DC	Set voltage, V DC (max.)	Reset voltage, V DC (max.)	Nominal operating current, mA (±10%)	Coil resistance, Ω (±10%)	Nominal operating power, mW	Max. allowable voltage, V DC
Standard PC board terminal	Self-clinching terminal							
TN2-L-3 V	TN2-L-H-3 V	3	2.25	2.25	33.3	90	100	4.5
TN2-L-4.5 V	TN2-L-H-4.5 V	4.5	3.38	3.38	22.2	202.5	100	6.7
TN2-L-5 V	TN2-L-H-5 V	5	3.75	3.75	20	250	100	7.5
TN2-L-6 V	TN2-L-H-6 V	6	4.5	4.5	16.7	360	100	9
TN2-L-9 V	TN2-L-H-9 V	9	6.75	6.75	11.1	810	100	13.5
TN2-L-12 V	TN2-L-H-12 V	12	9	9	8.3	1,440	100	18
TN2-L-24 V	TN2-L-H-24 V	24	18	18	6.3	3,840	150	36

3. 2 Coil latching

Part No.		Nominal voltage, V DC	Set voltage, V DC (max.)	Reset voltage, V DC (max.)	Nominal operating current, mA (±10%)	Coil resistance, Ω (±10%)	Nominal operating power, mW	Max. allowable voltage, V DC
Standard PC board terminal	Self-clinching terminal							
TN2-L2-3 V	TN2-L2-H-3 V	3	2.25	2.25	66.7	45	200	4.5
TN2-L2-4.5 V	TN2-L2-H-4.5 V	4.5	3.38	3.38	44.4	101.2	200	6.7
TN2-L2-5 V	TN2-L2-H-5 V	5	3.75	3.75	40	125	200	7.5
TN2-L2-6 V	TN2-L2-H-6 V	6	4.5	4.5	33.3	180	200	9
TN2-L2-9 V	TN2-L2-H-9 V	9	6.75	6.75	22.2	405	200	13.5
TN2-L2-12 V	TN2-L2-H-12 V	12	9	9	16.7	720	200	18
TN2-L2-24 V	TN2-L2-H-24 V	24	18	18	12.5	1,920	300	28.8

Notes:

1. Specified value of the pick-up, drop-out, set and reset voltage is with the condition of square wave coil pulse.
2. Standard packing: Tube: 50 pcs.; Case: 1,000 pcs.
3. In case of 5 V drive circuit, it is recommended to use 4.5 V type relay.
4. AgPd stationary contact types available for high resistance against contact sticking. When ordering, please add suffix "-3" like TN2-12V-3.

DIMENSIONS



Standard PC board terminal

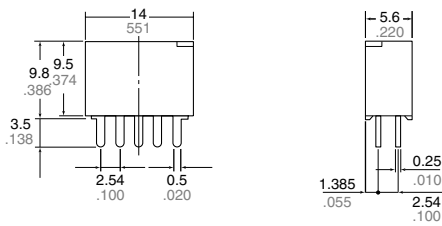

PC board pattern (Copper-side view)

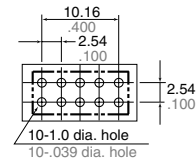

Tolerance: $\pm 0.1 \pm .004$

Self-clinching terminal

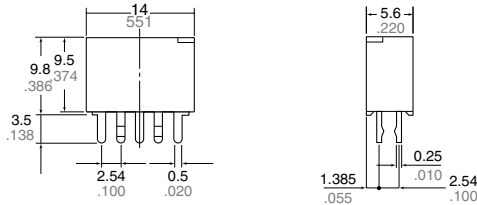

General tolerance: $\pm 0.3 \pm .012$

Schematic (Bottom view)

• Single side stable (Deenergized condition)

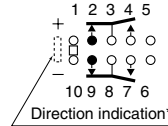

• 1-coil latching (Reset condition)

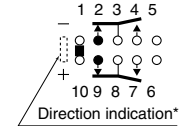

• 2-coil latching (Reset condition)

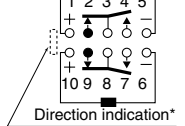

*Orientation stripe located on top of relay

REFERENCE DATA

1. Maximum switching capacity

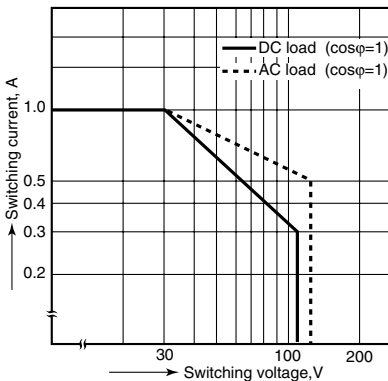

2. Life curve

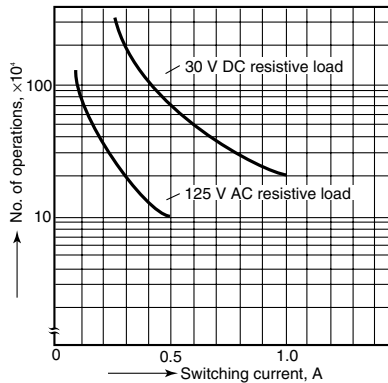

3. Mechanical life

Tested sample: TN2-12V, 10 pcs.

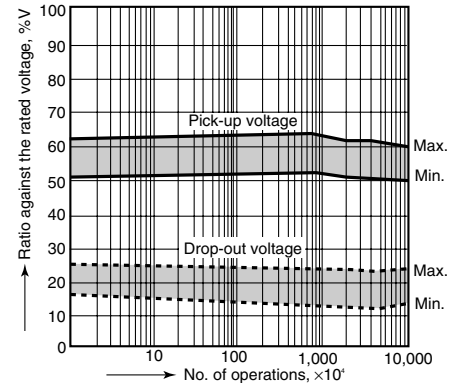

4. Electrical life (DC load)

Tested sample: TN2-12V, 10 pcs.

Condition: 1 A 30 V DC resistive load, 20 cpm

Change of pick-up and drop-out voltage

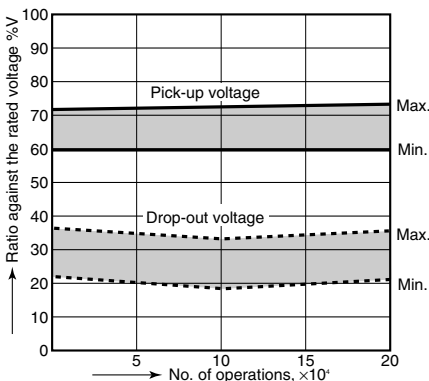

Change of contact resistance

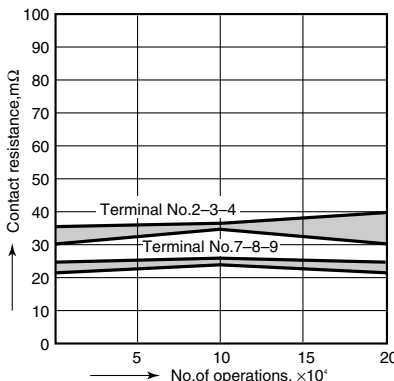

5. Coil temperature rise

Tested sample: TN2-12V

Point measured: Inside the coil

Ambient temperature: Room temperature (25° to 26°C), 70°C (77° to 79°F), 158°F

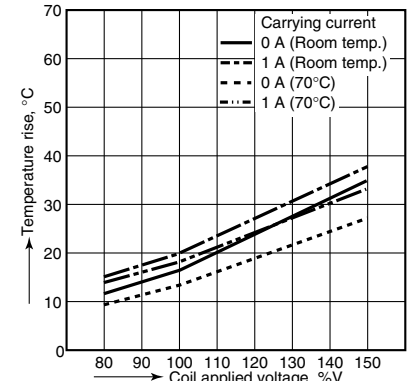

6. Operate/release time characteristics

Tested sample: TN2-12V, 5 pcs.

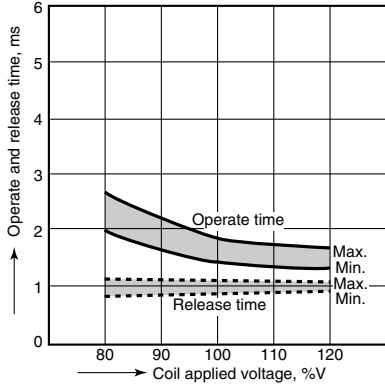

7. Set/reset time characteristics

Tested sample: TN2-L2-12V, 5 pcs.

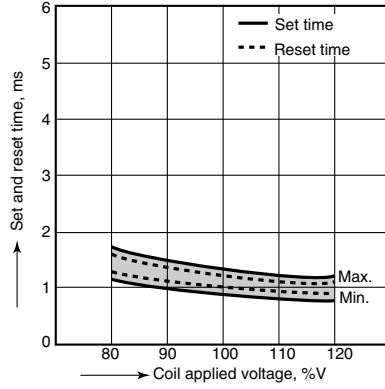

8. Distribution of pick-up and drop-out voltages

Tested sample: TN2-12V, 40 pcs.

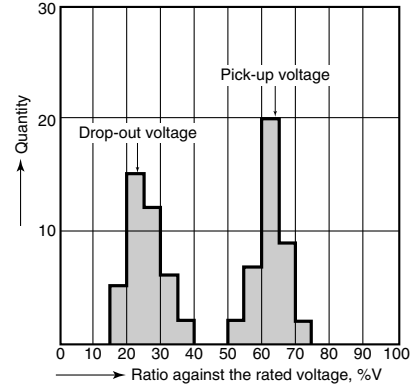

9. Distribution of set and reset voltage

Tested sample: TN2-L2-12V, 32 pcs.

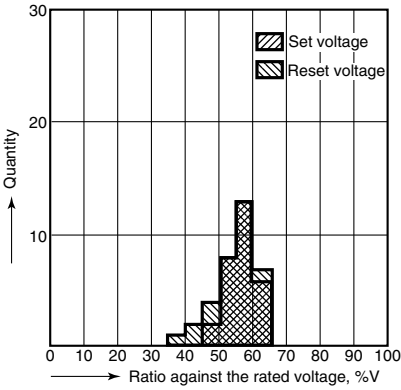

10. Ambient temperature characteristics

Tested sample: TN2-12V, 5 pcs.

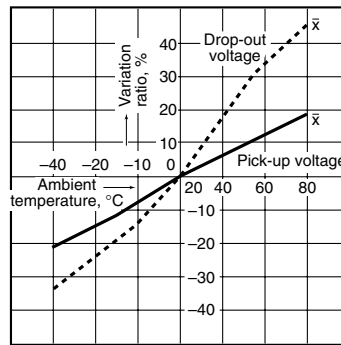

11. Distribution of contact resistance

Tested sample: TN2-12V, 38 pcs. (38x4 contacts)

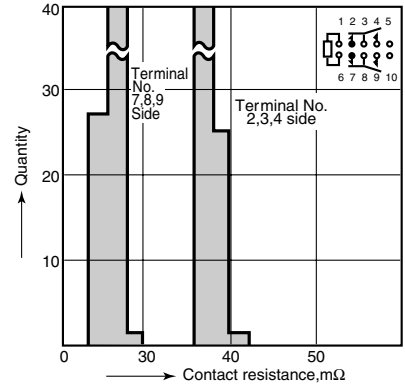

12-(1). Malfunctional shock (single side stable)

Tested sample: TN2-12V, 6 pcs.

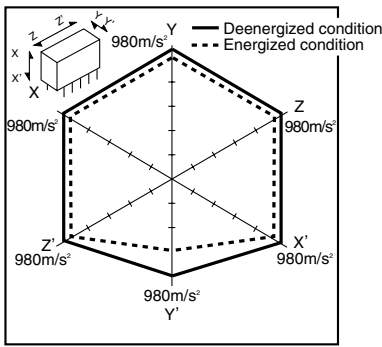

12-(2). Malfunctional shock (latching)

Tested sample: TN2-L2-12V, 6 pcs.

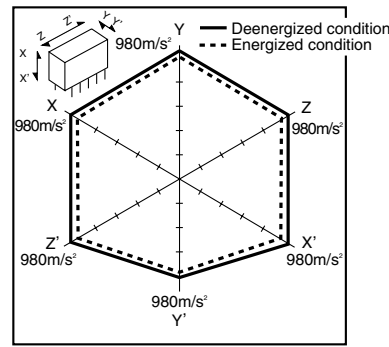

13-(1). Influence of adjacent mounting

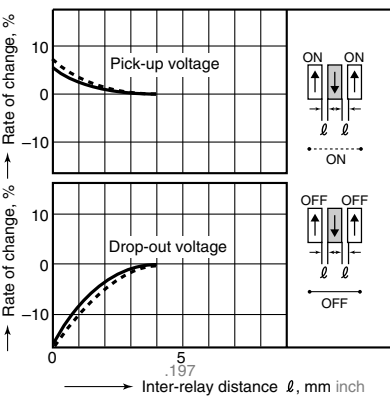

13-(2). Influence of adjacent mounting

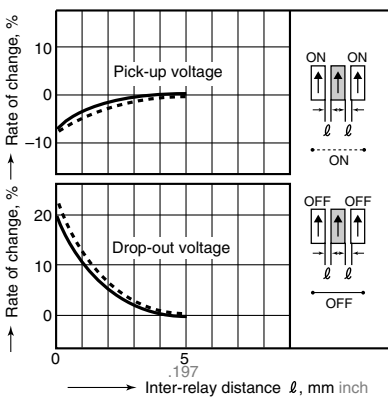

14. Actual load test
(35 mA 48 V DC wire spring relay load)

Circuit

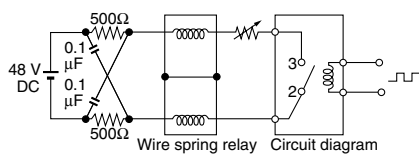

Change of pick-up and drop-out voltage

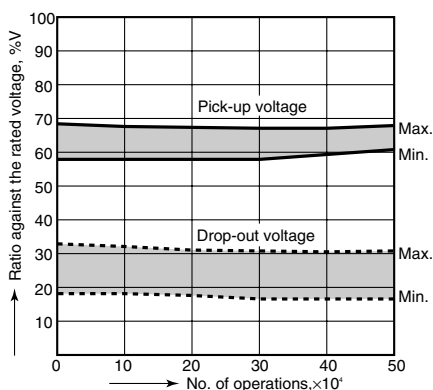

Change of contact resistance

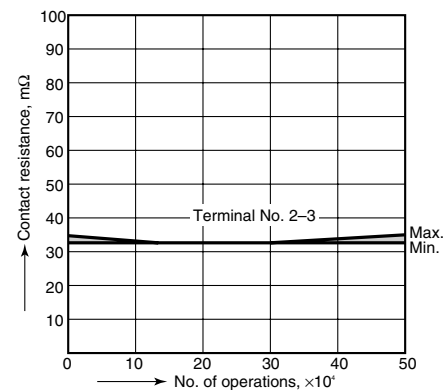

15-(1). High-frequency characteristics

Tested sample: TN2-xxV
Isolation characteristics

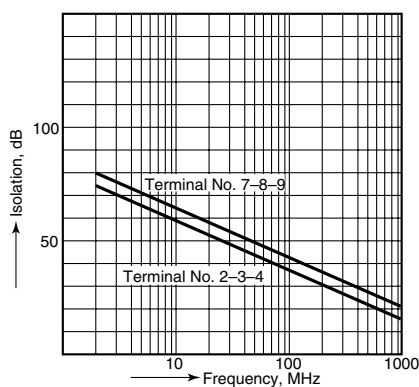

15-(2). High-frequency characteristics

Tested sample: TN2-xxV
Insertion loss characteristics

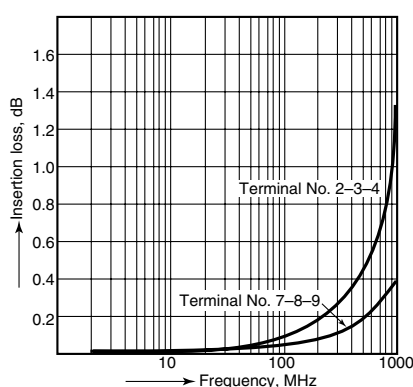

15-(3). High-frequency characteristics

Tested sample: TN2-xxV
V.S.W.R.

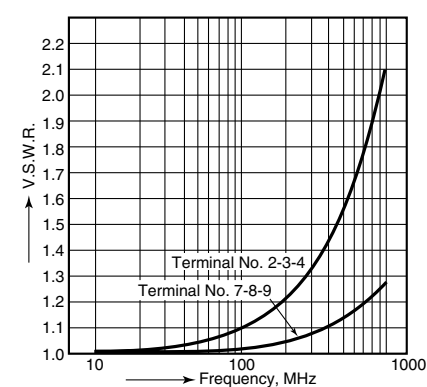

For Cautions for Use, see Relay Technical Information.